

DENSO

Spark Plugs & Glow Plugs

| Catalogue 2015/2016



Driven by
Quality

Catalogue | Overview

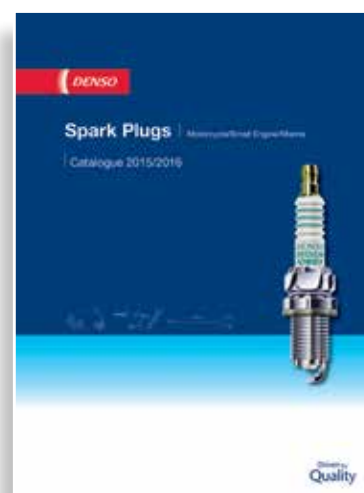
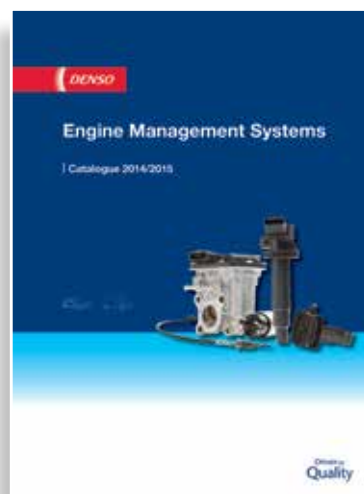
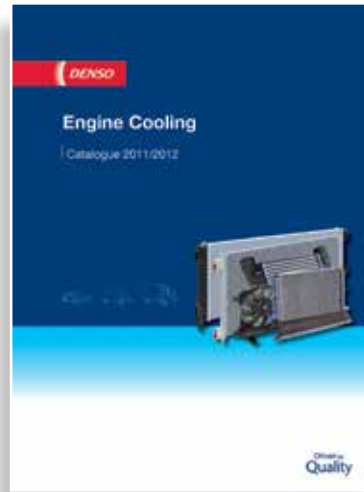
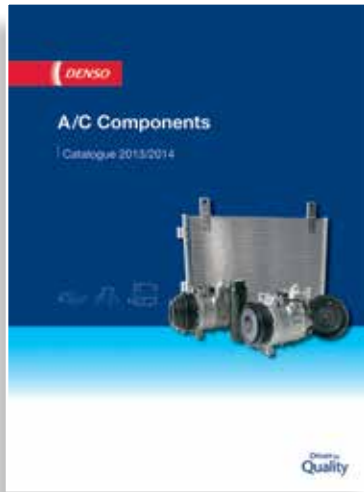

GB
Table of Contents

	SPARK PLUGS
4	Range
6	Installation
7	Characteristics
8	Identification Table
	GLOW PLUGS
10	Range
10	Installation
11	Characteristics
68	Range Updates
	SPARK/GLOW PLUGS
75	Application Tables
357	Buyers Guide
443	Cross Reference Chart
513	Iridium Upgrade
521	Photo Guide
539	Technical Overview
545	Abbreviations

D
Inhaltsverzeichnis

	ZÜNDKERZEN
12	Sortiment
14	Montage
15	Eigenschaften
16	Kennzeichnungstabelle
	GLÜHKERZEN
18	Sortiment
18	Montage
19	Eigenschaften
68	Erweiterung der Produktpalette
	ZÜNDKERZEN/ GLÜHKERZEN
75	Anwendungstabellen
357	Kundenführer
443	Querverweistabellen
513	Iridium-Aufrüstung
521	Fotoanweisung
539	Technische Daten im Überblick
545	Abkürzungen

F
Table des matières

	BOUGIES D'ALLUMAGE
20	Gamme
22	Installation
23	Caractéristiques
24	Tableau d'identification
	BOUGIES DE PRÉCHAUFFAGE
26	Gamme
26	Installation
27	Caractéristiques
68	Mises à jour des gammes
	BOUGIES D'ALLUMAGE/ BOUGIES DE PRÉCHAUFFAGE
75	Tableaux des affectations
357	Guide de l'acheteur
443	Tableau de correspondances
513	Mise à niveau Iridium
521	Guide photographique
539	Vue d'ensemble de la gamme
545	Abréviations

E
Índice

	BUJÍAS DE ENCENDIDO
28	Gama
30	Montaje
31	Características
32	Tabla de identificación
	BUJÍAS DE INCANDESCENCIA
34	Gama
34	Montaje
35	Características
68	Actualizaciones de la gama
	BUJÍAS DE ENCENDIDO/ BUJÍAS DE INCANDESCENCIA
75	Tablas de aplicaciones
357	Guía de Compra
443	Referencias Cruzadas
513	Cambio a Iridium
521	Guía de fotografías
539	Compendio técnico
545	Símbolos y abreviaturas

I
Indice

	CANDELE
36	Gamma
38	Installazione
39	Caratteristiche
40	Tabella di identificazione
	CANDELETTE DI PRERISCALDAMENTO
42	Gamma
42	Installazione
43	Caratteristiche
68	Guida per l'acquirente
	CANDELE/CANDELETTE DI PRERISCALDAMENTO
75	Tabelle delle applicazioni
357	Guida per l'acquirente
443	Tabella di riferimento
513	Aggiornamento Iridium
521	Guide fotografica
539	Informazioni tecniche
545	Abbreviazioni

SE
Innehållsförteckning

	TÄNDSTIFT
44	Produkter
46	Installation
47	Egenskaper
48	Identifieringstabell
	GLÖDSTIFT
50	Produkter
50	Installation
51	Egenskaper
68	Köpguide
	TÄNDSTIFT/GLÖDSTIFT
75	Tillämpningstabeller
357	Köpguide
443	Korsreferens
513	Iridium uppgradering
521	Foton
539	Teknisk översikt
545	Förkortningar

PL
Spis treści

	ŚWIECE ZAPŁONOWE
52	Oferta
54	Montaż
55	Charakterystyka
56	Tabela identyfikacyjna
	ŚWIECE ŻAROWE
58	Oferta
58	Montaż
59	Charakterystyka
68	Przewodnik kupującego
	ŚWIECE ZAPŁONOWE/ ŚWIECE ŻAROWE
75	Tabele zastosowań
357	Przewodnik kupującego
443	Tabela zamienników
513	Wymiana świec zapłonowych na irydowe
521	Przewodnik ze zdjęciami
539	Opis techniczny
545	Skróty

RU
Содержание

	СВЕЧИ ЗАЖИГАНИЯ
60	Ассортимент
62	Установка свечи зажигания
63	Устройство свечи зажигания
64	Система обозначения свечей зажигания
	СВЕЧИ НАКАЛИВАНИЯ
66	Ассортимент
66	Установка свечи накаливания
67	Устройство свечи накаливания
68	Обновления В
	Ассортименте СВЕЧИ ЗАЖИГАНИЯ И СВЕЧИ НАКАЛИВАНИЯ
75	Таблицы Применений
357	Руководство Для Покупателей
443	Таблица Соответствий
513	Таблица замены стандартных свечей на ТТ и иридиевые
521	Руководство-фотогид
539	Технические сведения
545	Сокращения

The DENSO difference

DENSO has been setting the standard for spark plug technology since 1959. We develop all of our ranges in-house, and manufacture them in our own QS 9000 and ISO 9000 certified factories worldwide – with 'zero defects' as standard. We also provide this outstanding OE quality to the aftermarket. Including Nickel, Platinum, Twin Tip and Iridium, DENSO Spark Plugs cover a complete range of continually updated references. Guaranteeing optimum engine performance, choose DENSO Spark Plugs for every automotive, motorcycle, marine and small engine application.

Range

Twin Tip (TT)

Nickel TT

- > Nickel alloy centre and a 'twin' protruding ground electrode
- > Low carbon dioxide emissions
- > Improved fuel efficiency
- > Smooth engine running even under extreme conditions
- > Best value for money performance spark plug

Iridium TT

- > Two ultra-fine, highly durable centre and ground electrodes
- > Improved performance of up to 20% compared with traditional Nickel plugs
- > Life span of 120,000 Km
- > Premium OEM technology now available at a lower price for a wider range of vehicles
- > Fuel savings

Direct Fit

Nickel

- > Copper glass seal helps heat dissipation
- > Standard U-groove
- > Deeply inserted copper core
- > Heat resistant nickel plating
- > Multi-ground electrode plugs available

Double Platinum (Longlife)

- > Improved, more reliable start
- > More complete combustion (lower emissions)
- > Improved ability to overcome tuning imperfections
- > Superior throttle response and acceleration
- > Race proven technology

Iridium Power

- > Superb ignitability
- > Low required voltage
- > Better acceleration response and operational stability
- > Lower fuel consumption

Iridium Longlife, Iridium Tough

- > Superb ignitability
- > Low required voltage
- > Better acceleration response and operational stability
- > Lower fuel consumption
- > Longer lifetime

Super Ignition Plug (SIP)

- > Two ultra-fine, highly durable centre and ground electrodes
- > Latest Spark Plug technology
- > OE fitted in Honda, Hyundai, Kia, Lexus, Nissan, Mitsubishi, Mazda, Subaru, Toyota & Volvo
- > Top performance
- > Long lifetime

Racing

Iridium Racing

- > F1 technology
- > Ultimate acceleration
- > High reliability
- > Boosted performance

Information in this catalogue is valid for the date of issue. Please refer to our e-Catalogue for the most up-to-date information.

The recommendations in this catalogue are based on the latest information from manufacturers for operating under standard conditions. We do not accept legal claims arising out of the contents of this list.

Cross reference information should be used for guidance only. Design and material differences between manufacturers may vary in the Heat Range. See the recommendations section for specific engine applications.

Where manufacturers' names and/or numbers are stated, these are given for reference purposes only and do not indicate the source of manufacture or any connection in the course of trade with the manufacturers named. In order to find the right spark plug please refer to the original part number (OEM) on the part and find the corresponding DENSO part number in the cross reference table.

Spark Plugs | Introduction

GB

Range	TT Range		Direct Fit							Racing
Material	Nickel	Iridium	Nickel	Platinum	Iridium					Iridium
Type	Nickel Twin Tip	Iridium Twin Tip	Nickel	Platinum	Iridium OEM ⁵	Iridium Long life ⁵	Iridium Power	Iridium Tough	SIP	Iridium Racing
U-groove	-	-	+ ¹	-	-	-	+ ²	-	-	-
Tapered cut ground electrode	-	Some types	Some types ³	-	-	-	+ ²	-	Some types	-
Material ground electrode	Nickel Alloy	Platinum tipped ⁶	Normal	Platinum tipped	Platinum tipped	Platinum tipped	Normal	Platinum tipped ⁷	Platinum tipped ⁶	Full Platinum
Centre electrode	1.5 mm	0.55 mm	2.5 mm	1.1 mm	0.7 mm	0.4 mm	0.4 mm	0.4 mm	0.55 mm	0.4 mm ⁴
Available heat range	16-20	20-24	9-27	16-22	16-22	16-27	16-34	16-24	20-24	24-35
Resistor	All Types	All Types	Most Types	All Types	All Types	All Types	All Types	All Types	All Types	All Types
High performance	+++	+++++	+	++	++++	++++	++++	++++	+++++	+++++
Fuel saving	Better	Best	Good	Better	Best	Best	Best	Best	Best	-
Life time	Standard	Long life	Standard	Long life	Long life	Long life	Standard	Long life	Long life	For racing only

¹ Spark plug types without a 'U' in the type name do not have a U-groove

² Not applicable to IU24A, IU27A, IU31A, IUF27A and IUF31A

³ Spark plug types with a 'Z' in the type name have a tapered cut ground electrode

⁴ Except for surface gap types

⁵ OEM Types, only for specific vehicles

⁶ Needle Platinum 0.7mm

⁷ Needle Platinum 0.7mm available

GB

Spark plug installation

Recommended Torque and Tightening Angle for DENSO plugs.

1. Use the correct wrench for the hex on the plug, and be careful not to damage the insulator.
2. When changing, make sure that the oil, etc. on the outside of the plug does not enter the engine interior.
3. When putting the plugs in, clean the engine side of the flange and put in the plugs after making sure the gasket is in the flange.
4. Make sure the plugs are vertical and tighten them by hand until they cannot be tightened any further (A+B).
5. Then use a torque wrench to tighten to the accurate torque value as shown in the chart below. When no torque wrench is available, use a spark plug wrench to tighten with the recommended turns. For further information on the absolute torque value, please visit our e-catalogue.

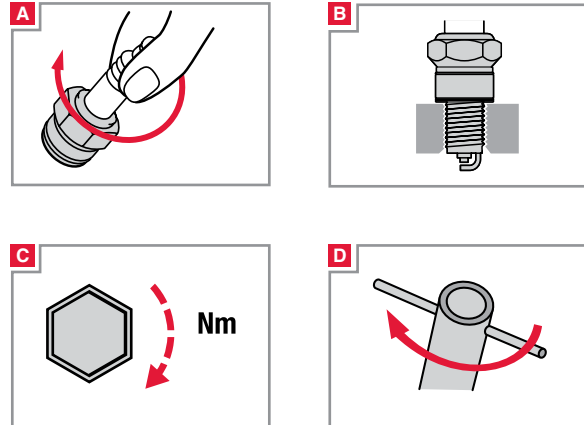

UK: <http://www.denso-am.co.uk/e-catalogue/>
 EU: <http://www.denso-am.eu/e-catalogue/>

RECOMMENDED INSTALLATION TORQUE SPECIFICATION					
Thread size	Recomm- ended Torque	Recommended Turns		New plug	Used plug
Gasket	M8 Y type	8-10 Nm	± 1 turn	± 1/12 turn	
	M10 U, N type	10-15 Nm	± 2/3 turn	± 1/12 turn	
	M10 Stainless steel gasket	10-15 Nm	± 3/4 turn	± 1/12 turn	
	M12 SXU, X, XE, XU, ZXE, ZXU type	15-20 Nm	± 1/3 turn	± 1/12 turn	
	M14 FK, J, K, KJ, P, PK, PKJ, PQ, Q, QJ, QL, S, SF, SK, SKJ, SV, SVK, VK, VKJ, W, ZT type	20-25 Nm	± 1/2 turn	± 1/12 turn	
	M14 Stainless steel gasket	20-25 Nm	± 2/3 turn	± 1/12 turn	
	M18 L, M, MA, MW type	30-40 Nm	± 1/4 turn	± 1/12 turn	
Taper seat	M14 PT, PTJ, T type	20-30 Nm	± 1/16 turn	± 1/16 turn	
	M18 MA type	30-40 Nm	± 1/4 turn	± 1/12 turn	



If a thread lubricant such as grease is coated on the thread, tightening to the recommended torque is tightening too much; this has been linked to seal leakage. Do not use a thread lubricant.

Tightening more than the tightening angles and torques shown in the above table could result in damage to the engine and furthermore could result in the plug coming off at the thread.

Spark Plugs | Characteristics

GB

Spark Plug Characteristics

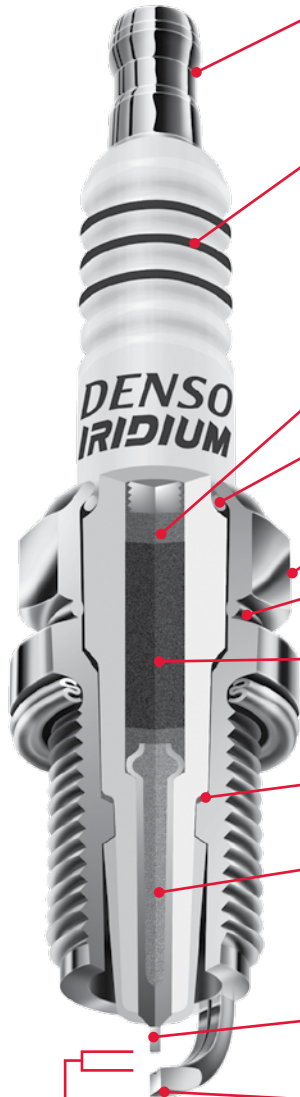

Terminal

- > Thread, removable, crimped or solid

Ceramic insulator

- > The five rib design is used throughout the surface
- > This reduces voltage loss and prevents missed sparks
- > High-purity alumina is used
- > Good electrical insulation, durability and thermal conductivity
- > Chemically stable

Special copper-glass seal

- > Air tightness, durability and thermal conductivity are good.

Ring

Housing

- > A highly corrosion resistant nickel plating

Electrical heat seal

- > Heat resistance, gives good hermeticity and low variation in heat range.

Resistor

- > With a 5 K Ω resistance, reduces radio noise.

Packing

Copper cored center electrode

- > Compared to other manufacturers, DENSO uses higher copper concentrations for better thermal properties
- > From low to high speeds, a strong steady spark.

Center electrode

- > DENSO's iridium plugs have the world's smallest 0,4mm diameter center electrode

Ground electrode

- > Available with U-groove which gives a more complete combustion
- > Taper cut results in a steady ignition.
- > Available with Platinum tip for long lifetime
- > Available with needle tip for long lifetime and best ignitability

Spark gap

- > Most DENSO Spark Plugs are pre-gapped to fit your application, you don't need to gap it yourself

Spark Plugs | Identification Table

GB



Nickel Plugs, Platinum Plugs and Iridium plugs

IDENTIFYING DENSO SPARK PLUGS																																																														
	W	16	E	XR	-U	11																																																								
S	K	20		PR	-A	11																																																								
S	XU	22	H	CR	-11S																																																									
Type of precious metal	Thread Diameter and Hex Size	Heat Range	Reach	Shape (Type)	Shape (Type)	Gap																																																								
D ... Ø 0.7 mm iridium with needle type platinum (SIP) F ... Ø 0.55 mm iridium with needle type platinum (SIP) P ... Ø 1.1 mm platinum with platinum tip S ... Ø 0.7 mm iridium with platinum tip SV ... Ø 0.4 mm iridium with platinum tip Z ... Ø 0.55 mm iridium with platinum tip	C 12x14.0 L 18x22.2 (Reach: 12.7 mm) M 18x25.4 (Reach: 12 mm) MA 18x20.6 (Taper seat, Reach: 12 mm) MW 18x20.6 (Reach: 12 mm) J 14x20.6 (Projected plug) K 14x16.0 (Miniature plug) KJ 14x16.0 (Projected Miniature plug) LP 14x20.6 (Plug for LPG applications) Q 14x16.0 (Miniature plug) QJ 14x16.0 (Projected Miniature plug) QL 14x20.6 (Miniature long cylinder housing plug) S 14x20.6 (Surface gap plug (for RE engines)) T 14x16.0 (Taper seat) W 14x20.6 14x19.0 (Compact type) X 12x18.0 XE 12x14.0 XU 12x16.0 N 10x16.0 U 10x16.0 Y 8x13.0	<table border="1"> <thead> <tr> <th>DENSO</th> <th>NGK</th> <th>CHAMPION</th> <th>BOSCH</th> </tr> </thead> <tbody> <tr> <td>4</td> <td></td> <td></td> <td></td> </tr> <tr> <td>9</td> <td>2</td> <td>18</td> <td>10</td> </tr> <tr> <td>14</td> <td>4</td> <td>16,14</td> <td>9</td> </tr> <tr> <td>16</td> <td>5</td> <td>12,11</td> <td>8</td> </tr> <tr> <td>20</td> <td>6</td> <td>10,9</td> <td>7,6</td> </tr> <tr> <td>22</td> <td>7</td> <td>8,7</td> <td>5</td> </tr> <tr> <td>24</td> <td>8</td> <td>6,63,61</td> <td>4</td> </tr> <tr> <td>27</td> <td>9</td> <td>4,59</td> <td>3</td> </tr> <tr> <td>29</td> <td>9.5</td> <td>57</td> <td></td> </tr> <tr> <td>31</td> <td>10</td> <td>55</td> <td>2</td> </tr> <tr> <td>32</td> <td>10.5</td> <td>53</td> <td></td> </tr> <tr> <td>34</td> <td>11</td> <td></td> <td></td> </tr> <tr> <td>35</td> <td>11.5</td> <td></td> <td></td> </tr> </tbody> </table>	DENSO	NGK	CHAMPION	BOSCH	4				9	2	18	10	14	4	16,14	9	16	5	12,11	8	20	6	10,9	7,6	22	7	8,7	5	24	8	6,63,61	4	27	9	4,59	3	29	9.5	57		31	10	55	2	32	10.5	53		34	11			35	11.5			A 19.0 mm (Spark position: 7.0 mm) J16AR-U11 A 21.5 mm S29A B 19.0 mm (Spark position: 9.5 mm) J16BR-U C 19.0 mm (Spark position: 5.0 mm) KJ20CR-L11 D 19.0 mm (Shroud 2) K20DTR-S11 E (With gasket) ... 19.0 mm W16EX-U E (With gasket) ... 20.0 mm W25EBR E (Taper seat) ... 19.0 mm T16EPR-U F 12.7 mm W20FP-U FE 19.0 mm (Half thread) U24FER9 G 19.0 mm (Shroud 3.5) PK20GR8 G 19.0 mm (Shroud 3) X27GPR-U H ... 26.5 mm QJ16HR-U H 19.0 mm (Spark position: 8.5 mm) K16HPR-U11 L 11.2 mm W14L N (Taper seat, Half thread) - 17.5 mm T20NR-U11 V (Taper seat) ... 25.0 mm PT16VR13 None ... 9.5 mm W14M-U 11.2 mm L14-U, M24S 19.0 mm SK20R11 21.5 mm S29A None (Taper seat) ... 8.3 mm T20M-U 11.2 mm T16PR-U	A ... Double ground electrodes W22EA AY ... Double ground electrodes with bent shape J16AY B ... Triple ground electrodes W22EB BG ... Triple ground electrodes (shroud) SK20BGR11 C ... Shroud 1.5mm SXU22HCR11 D ... 4 ground electrodes W27EDR D ... Projected (1.5 mm projection, spark position 3.5 mm) XU22HDR9 E ... Shroud: 2.0mm FXE20HE11 K ... Projected (1 mm projection) W16EKR-S11 LM ... Compact type (Hex 20.6 mm) W14LM-U M ... Shortened insulator head length W27EMR-C M ... Compact type (Hex 19.0 mm) W20M-U P ... Projected (1.5 mm projection) W16EP-U Q ... Projected 2mm, Spark position 3.5mm R ... 5Kohm resistor K16R-U S ... Non-projected (0 mm Projection) W22ES-U S ... Iridium on a single side KJ20SR11 T ... Double ground electrodes K16TR11 TM ... Double ground electrodes K22TMR11 TN ... Double ground electrodes K22TNR-S X ... Fully projected (2.5 mm Projection) W16EX-U	-A ... Special specification SK16PR-A11 -B ... Special specification K16PSR-B8 -C ... Cut-back ground electrode W27EMR-C -D ... Copper-core Ground DK20PR-D13 -E ... Special specification SK16PR-E11 -F ... Special specification SK16PR-F11 -G ... Grease applied on to threads, for CNG SK20R8-G -GL ... Platinum center electrode X22EPR-GL -L ... Heat resistant ground electrode K20PR-L11 -L ... 3.5 mm projected insulator for motorcycles W20FP-UL -L ... Retracted insulator for motorcycles W20FR-L -M ... Larger ground electrode SK20PR-M11S -N ... For Yamaha and Kawasaki U27ESR-N -P ... Double Platinum Ground Electrode SK20R-P11 -P ... Single-sided platinum plug K16PR-P11 -R ... 10K ohm resistor K22PR-UR -S ... Semi-surface gap discharge type W20EP-S11 -S ... Stainless gasket U27FER9S -T ... For LPG SK20HR8-T -T ... Special specification FK20HBR11-T -TP ... Taper-cut, single-side platinum plug K20PR-TP11 -U ... U groove ground electrode K16PR-U -US ... Star-shaped center electrode W20M-US -V ... 1.3 mm diameter, nickel center electrode W27ES-V	5 ... 0.5 mm (.020") 8 ... 0.8 mm (.032") 9 ... 0.9 mm (.035") 10 ... 1.0 mm (.040") 11 ... 1.1 mm (.044") 13 ... 1.3 mm (.050") 14 ... 1.4 mm (.055") 15 ... 1.5 mm (.060") <None> Cars: 0.8 mm M/C: 0.7 mm <Exceptions> P16R, PQ16R, PQ20R are 1.1 mm
	DENSO	NGK	CHAMPION	BOSCH																																																										
	4																																																													
	9	2	18	10																																																										
	14	4	16,14	9																																																										
	16	5	12,11	8																																																										
	20	6	10,9	7,6																																																										
	22	7	8,7	5																																																										
	24	8	6,63,61	4																																																										
	27	9	4,59	3																																																										
	29	9.5	57																																																											
	31	10	55	2																																																										
	32	10.5	53																																																											
	34	11																																																												
	35	11.5																																																												

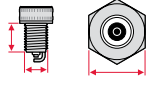

Spark Plugs | Identification Table

GB

Iridium Power, Iridium Tough

IDENTIFYING DENSO SPARK PLUGS																																															
I	U	27	A																																												
VF	KH	20																																													
																																															
High Performance Plug	Thread Diameter, Reach and Hex Size	Heat Range		Shape (Type)																																											
I Ø 0.4 mm iridium V Ø 0.4 mm iridium with platinum tip VF ... Ø 0.4 mm iridium with needle type platinum tip (SIP)	<Thread Diameter x Reach x Hex Size> (mm) CH ... 12x26.5x14.0 K 14x19.0x16.0 KA ... 14x19.0 (Shrouded, New Triple Electrodes)x16.0 KB ... 14x19.0 (New Triple Electrodes)x16.0 KBH ... 14x26.5 (New Triple Electrodes)x16.0 KD ... 14x19.0 (Shrouded)x16.0 KH ... 14x26.5x16.0 NH ... 10x19.0 (Half Thread)x16.0 T 14x17.5 (Taper Seat)x16.0 TF ... 14x11.2 (Taper Seat)x16.0 TL ... 14x25.0 (Taper Seat, Long Insulator)x16.0 TV ... 14x25.0 (Taper Seat)x16.0 Q 14x19.0x16.0 U 10x19.0x16.0 UF ... 10x12.7x16.0 UH ... 10x19.0 (Half Thread)x16.0 W 14x19.0x20.6 WF ... 14x12.7x20.6 WM ... 14x19.0x20.6 (Compact Insulator) X 12x19.0x18.0 XEH ... 12x26.5 (Shroud 2.0)x14.0 XG ... 12x19.0 (Shroud 3.0)x18.0 XU ... 12x19.0x16.0 XUH ... 12x26.5x16.0 Y 8x19.0 (Half Thread)x13.0	<table border="1"> <thead> <tr> <th>DENSO</th> <th>NGK</th> <th>CHAMPION</th> <th>BOSCH</th> </tr> </thead> <tbody> <tr> <td>16</td> <td>5</td> <td>12,11</td> <td>8</td> </tr> <tr> <td>20</td> <td>6</td> <td>10,9</td> <td>7,6</td> </tr> <tr> <td>22</td> <td>7</td> <td>8,7</td> <td>5</td> </tr> <tr> <td>24</td> <td>8</td> <td>6,63,61</td> <td>4</td> </tr> <tr> <td>27</td> <td>9</td> <td>4,59</td> <td>3</td> </tr> <tr> <td>29</td> <td>9.5</td> <td>57</td> <td></td> </tr> <tr> <td>31</td> <td>10</td> <td>55</td> <td>2</td> </tr> <tr> <td>32</td> <td>10.5</td> <td>53</td> <td></td> </tr> <tr> <td>34</td> <td>11</td> <td></td> <td></td> </tr> <tr> <td>35</td> <td>11.5</td> <td></td> <td></td> </tr> </tbody> </table>	DENSO	NGK	CHAMPION	BOSCH	16	5	12,11	8	20	6	10,9	7,6	22	7	8,7	5	24	8	6,63,61	4	27	9	4,59	3	29	9.5	57		31	10	55	2	32	10.5	53		34	11			35	11.5			A Slant electrode, No U-Groove, No taper cut B Projected insulator (1.5 mm) C No U-Groove D No U-Groove, Inconel ground electrode E Shroud: 2 mm ES ... Stainless steel gasket F Special specification G Stainless steel gasket I Spark position: 4 mm Projected insulator (1.5 mm) J Spark position: 5 mm K Spark position: 4 mm Projected insulator (2.5 mm) L Spark position: 5 mm T For LPG applications Y 0.8 mm gap Z Taper cut
DENSO	NGK	CHAMPION	BOSCH																																												
16	5	12,11	8																																												
20	6	10,9	7,6																																												
22	7	8,7	5																																												
24	8	6,63,61	4																																												
27	9	4,59	3																																												
29	9.5	57																																													
31	10	55	2																																												
32	10.5	53																																													
34	11																																														
35	11.5																																														

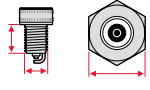
TT Series

IDENTIFYING DENSO SPARK PLUGS																			
I	W	16	TT																
	XEH	20	ETT																
																			
Type of precious metal	Thread Diameter, Reach and Hex Size	Heat Range		Shape (Type)															
I Ø 0.4 mm iridium with needle type platinum tip	<Thread Diameter x Reach x Hex Size> (mm) K 14x19.0x16.0 KBH ... 14x26.5 (New Triple Electrodes)x16.0 KH ... 14x26.5x16.0 Q 14x19.0x16.0 T 14x17.5 (Taper Seat)x16.0 TF ... 14x11.2 (Taper Seat)x16.0 TL ... 14x25.0 (Taper Seat, Long Insulator)x16.0 TV ... 14x25.0 (Taper Seat)x16.0 W 14x19.0x20.6 WF ... 14x12.7x20.6 XEH ... 12x26.5 (Shroud 2.0)x14.0 XU ... 12x19.0x16.0 XUH ... 12x26.5x16.0	<table border="1"> <thead> <tr> <th>DENSO</th> <th>NGK</th> <th>CHAMPION</th> <th>BOSCH</th> </tr> </thead> <tbody> <tr> <td>16</td> <td>5</td> <td>12,11</td> <td>8</td> </tr> <tr> <td>20</td> <td>6</td> <td>10,9</td> <td>7,6</td> </tr> <tr> <td>22</td> <td>7</td> <td>8,7</td> <td>5</td> </tr> </tbody> </table>	DENSO	NGK	CHAMPION	BOSCH	16	5	12,11	8	20	6	10,9	7,6	22	7	8,7	5	E Shroud: 2 mm IXEH20ETT TT ... Nickel TT (Ø 1.5 mm centre, Ø 1.5 mm ground electrode) W16TT TT ... Iridium TT (Ø 0.4 mm centre, Ø 0.7 mm ground electrode) IW16TT I Spark position: 4 mm Projected insulator (1.5 mm) XUH20TTI
DENSO	NGK	CHAMPION	BOSCH																
16	5	12,11	8																
20	6	10,9	7,6																
22	7	8,7	5																



Glow Plug Range

DENSO's Glow Plug programme is a major OE quality, all-makes introduction; launched to provide Aftermarket customers with an alternative, advanced branded choice for their growing Diesel needs.

The cutting edge programme benefits from DENSO Corporation's pedigree as a world leading OE manufacturer of Glow Plugs for leading automotive suppliers around the world. Engineered to OE standards, our Aftermarket Glow Plug programme comprises 138 part numbers covering more than 4,800 applications; equivalent to 98% of the European parc. Ongoing extensions are planned to continually enhance and update the range.

The DENSO Glow Plug programme encompasses all current Glow Plug technologies including single coil, double coil, extended post-heating, ceramic Glow Plugs and instant heating.

DENSO Glow Plugs feature:

- > OE quality Glow Plugs that meet or exceed manufacturers' specifications
- > Faster heat-up times and a reliable cold-start
- > Extended post-heat temperatures for lower emissions
- > Excellent coverage ensures suitability for almost every diesel engine in Europe
- > More applications covered with fewer part references
- > Easy to use part numbering system
- > Meets ISO TS16949, ISO14001 and OHSAS 18001 standards

How to install a Glow Plug

Recommended torque specification for DENSO Glow Plugs:

1. Use the correct wrench for the Glow Plug and Terminal.
2. When changing Glow Plugs, make sure that oil, dirt etc. on the outside of the disassembled Glow Plug does not enter into the cylinder.
3. When mounting the Glow Plug, clean the engine side of the flange and make sure the Glow Plug is correctly inline with the thread of the cylinderhead.
4. Make sure the plug is correctly positioned and tighten it by hand until it cannot be tightened any further.
5. Then, use a torque wrench to tighten it accurately to the torque showed in the chart below.

RECOMMENDED INSTALLATION TORQUE SPECIFICATION		
	Thread size	Recommended torque
Glow plug	M8x1.00	8-10 Nm
	M9x1.00	8-10 Nm
	M10x1.00	10-12 Nm
	M10x1.25	10-12 Nm
	M12x1.25	15-20 Nm
	M14x1.25	20-25 Nm
Terminal	M4x0.7	1-1.5 Nm
	M5x0.8	3-4 Nm

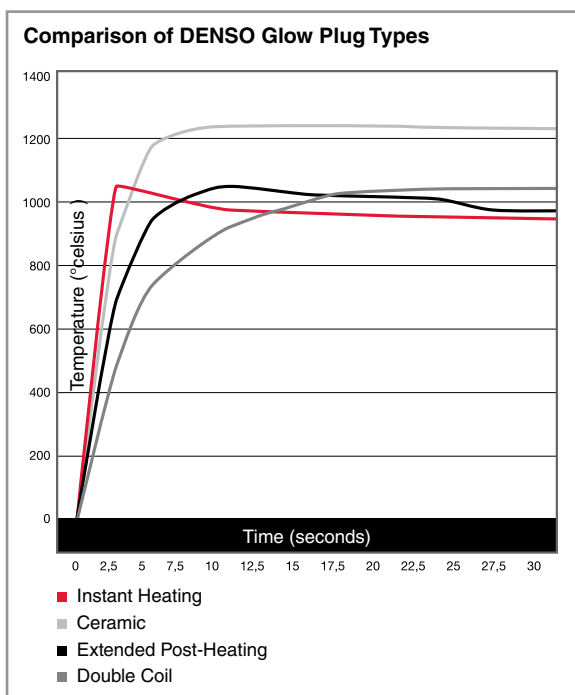

! DO NOT USE A THREAD LUBRICANT! If a thread lubricant such as grease is coated on the tread, the resistance between the Glow Plug and the cylinderhead will be less > resulting in over tightening.

! Tightening more than the torques shown in the table could result in damage to the Glow Plug and engine.

! Glow Plug failure is most commonly caused by excessive voltage and/or heat. Glow Plugs are designed to operate between 850 to 1100 degrees. When the electrical current to the Glow Plug is held too long, either because of a faulty relay and/or controller, it can lead to overheating which will cause the Glow Plug to swell, split or burst and cause immediate failure. Therefore it is advisable to check out the entire electrical system before changing to new Glow Plugs. Overly advanced injection timing, leaky injectors, or petrol running in your engine will cause the combustion temperature to increase too much; damaging the Glow Plugs. **A faulty relay and controller can also cause Glow Plug failure** so it is advisable to check out the entire system before changing to new Glow Plugs.

Glow Plugs | Characteristics

GB

The blueprint for superior Glow Plug technology

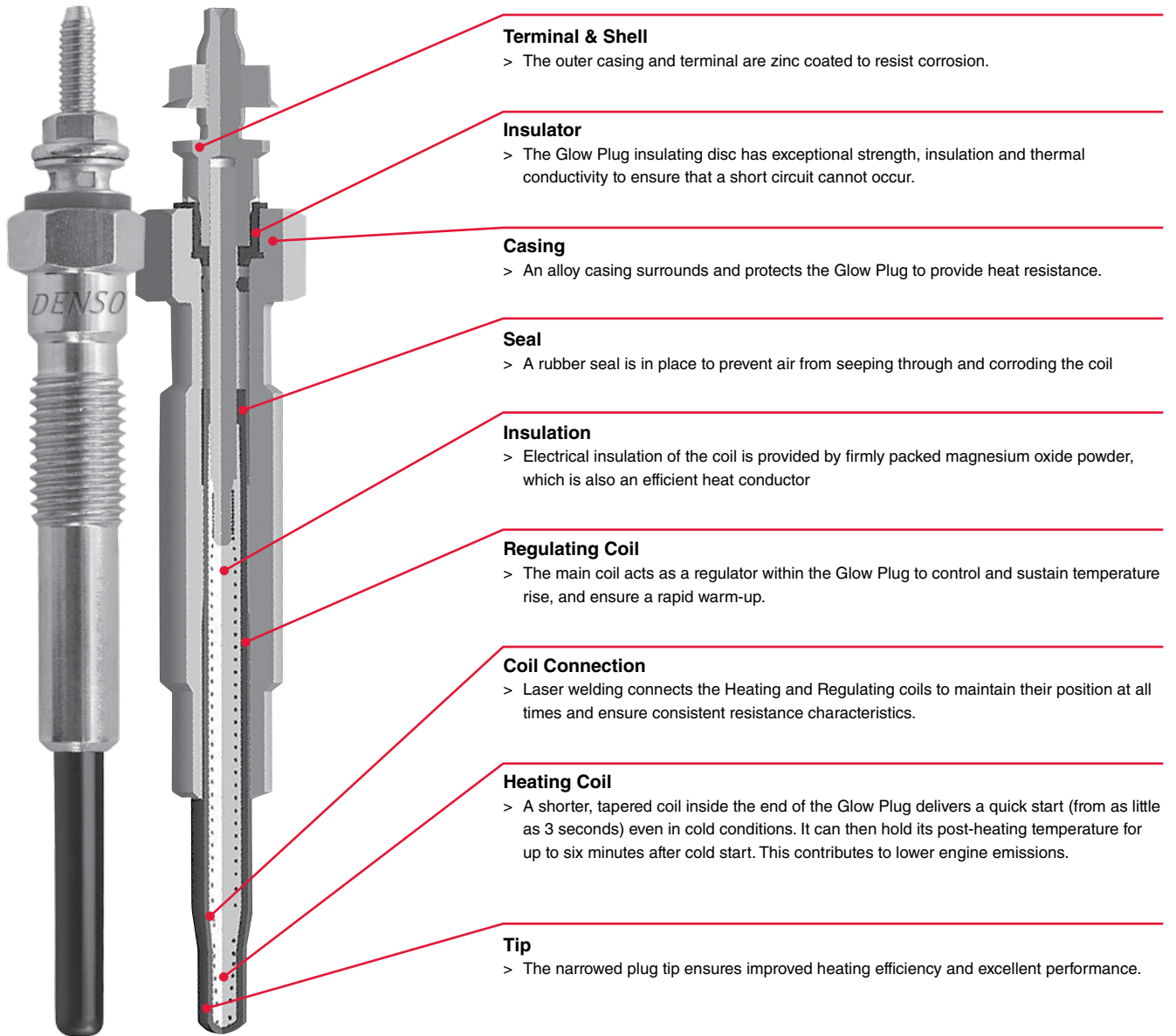

Terminal & Shell

> The outer casing and terminal are zinc coated to resist corrosion.

Insulator

> The Glow Plug insulating disc has exceptional strength, insulation and thermal conductivity to ensure that a short circuit cannot occur.

Casing

> An alloy casing surrounds and protects the Glow Plug to provide heat resistance.

Seal

> A rubber seal is in place to prevent air from seeping through and corroding the coil

Insulation

> Electrical insulation of the coil is provided by firmly packed magnesium oxide powder, which is also an efficient heat conductor

Regulating Coil

> The main coil acts as a regulator within the Glow Plug to control and sustain temperature rise, and ensure a rapid warm-up.

Coil Connection

> Laser welding connects the Heating and Regulating coils to maintain their position at all times and ensure consistent resistance characteristics.

Heating Coil

> A shorter, tapered coil inside the end of the Glow Plug delivers a quick start (from as little as 3 seconds) even in cold conditions. It can then hold its post-heating temperature for up to six minutes after cold start. This contributes to lower engine emissions.

Tip

> The narrowed plug tip ensures improved heating efficiency and excellent performance.

Der DENSO-Unterschied

In der Zündkerzentechnologie hat DENSO seit 1959 Standards aufgestellt. Wir entwickeln alle unsere Produktreihen im eigenen Hause; die Produktion erfolgt in unseren eigenen, gemäß QS 9000 und ISO 9000 zertifizierten Werken in allen Teilen der Welt – und fehlerfreie Fertigung gehört selbstverständlich zum Standard. Mit dieser herausragenden OE-Qualität beliefern wir auch den Aftermarket. Über die Produktreihen Nickel, Platin, Twin Tip und Iridium hinaus, decken Zündkerzen von DENSO ein komplettes Spektrum kontinuierlich aktualisierter Anwendungen ab. Mit seinen wegweisenden Technologien und der alle Marken umfassenden Auswahl garantiert das DENSO Zündkerzenprogramm eine optimale Motorleistung von Kraftfahrzeugen, Motorrädern, Bootsmotoren und Kleinmotoranwendungen.

Sortiment

Twin Tip (TT)

Nickel TT

- > Mittelelektrode aus Nickellegierung und doppelte Masselektrode
- > Geringe Kohlendioxidemissionen
- > Besserer Kraftstoffverbrauch
- > Hohe Laufruhe des Motors, selbst unter extremen Bedingungen
- > Hochleistungs-Zündkerze mit dem besten Preis-Leistungs-Verhältnis

Iridium TT

- > Verbessertes, verlässlicheres Startverhalten
- > Bis zu 20% bessere Leistung im Vergleich zu herkömmlichen Nickel-Kerzen
- > Standzeit von 120.000 km
- > Premium OEM Technologie jetzt zu einem günstigeren Preis für eine noch breitere Fahrzeugpalette erhältlich
- > Kraftstoffeinsparungen

Informationen in diesem Katalog entsprechen dem Stand des Erscheinungsdatums. Die aktuellsten Informationen finden Sie online in unserem E-Katalog.

Die Empfehlungen in diesem Katalog basieren auf den neuesten Informationen der Hersteller zum Betrieb unter normalen Bedingungen. Wir schließen jegliche Haftungsansprüche aufgrund des Inhalts dieses Katalogs aus.

Cross-Referenzen bzw. Querverweisinformationen dienen nur als Orientierungshilfe. Design- und Materialunterschiede zwischen den Herstellern können im Wärmebereich variieren. Angaben zu speziellen Anwendungen finden Sie im Kapitel Empfehlungen.

Angegebene Herstellernamen und/oder -nummern dienen nur Orientierungszwecken und sind keine verbindlichen Aussagen zum Hersteller oder irgendeiner Beziehung zum Hersteller im Rahmen der Geschäftstätigkeit. Um die richtige Zündkerze zu finden, prüfen Sie bitte die Originalteilenummer (OEM) auf dem Produkt und ermitteln sie die entsprechende DENSO Teilenummer in der Cross-Referenzen-Tabelle/ Querverweistabelle.

Direkteinbaukerzen

Nickel

- > Abdichtung mit Kupferglasschmelze fördert Wärmeableitung
- > Standardmäßige U-Rille
- > Tiefliegender Kupferkern
- > Wärmebeständige Nickelummantelung
- > Zündkerzen mit Mehrfach-Elektroden erhältlich

Double Platinum (Longlife)

- > Verbessertes, verlässlicheres Startverhalten
- > Vollständigere Verbrennung (geringere Schadstoffemissionen)
- > Stärkere Kompensation von Tuningmängeln
- > Spontane Gasannahme und bessere Beschleunigung
- > Rennsporterprobte Technologie

Iridium Power

- > Überlegenes Zündverhalten
- > Niedriger Zündspannungsbedarf
- > Besseres Beschleunigungsverhalten, bessere Betriebsstabilität
- > Reduzierter Kraftstoffverbrauch

Iridium Longlife, Iridium Tough

- > Überlegenes Zündverhalten
- > Niedriger Zündspannungsbedarf
- > Besseres Beschleunigungsverhalten, bessere Betriebsstabilität
- > Reduzierter Kraftstoffverbrauch
- > Längere Lebensdauer

Superzündkerze (SIP)

- > Zwei äußerst dünne, hoch verschleißfeste Mittel- und Masselektroden
- > Neueste Zündkerzentechnologie
- > Wird als Erstausrüstung in Honda, Hyundai, Kia, Lexus, Nissan, Mitsubishi, Mazda, Subaru, Toyota und Volvo eingebaut.
- > Spitzenleistung
- > Lange Standzeit

Rennzündkerzen

Iridium Racing

- > F1-Technologie
- > Ultimative Beschleunigung
- > Hohe Verlässlichkeit
- > Gesteigerte Leistungsabgabe

Sortiment	TT-Sortiment		Direkteinbaukerzen							Rennzündkerzen
Material	Nickel	Iridium	Nickel	Platinum	Iridium					Iridium
Typ	Nickel TwinTip	Iridium TwinTip	Nickel	Platinum	Iridium OEM ⁵	Iridium Long life ⁵	Iridium Power	Iridium Tough	SIP	Iridium Racing
U-Rille	-	-	+ ¹	-	-	-	+ ²	-	-	-
Konisch zulaufende Masselektrode	-	Einige Typen	Einige Typen ³	-	-	-	+ ²	-	Einige Typen	-
Werkstoff der Masselektrode	Nickellegierung	Platinspitze ⁶	Normal	Platinspitze	Platinspitze	Platinspitze	Normal	Platinspitze ⁷	Platinspitze ⁶	Platin massiv
Mittелеlektrode	1.5 mm	0.55 mm	2.5 mm	1.1 mm	0.7 mm	0.4 mm	0.4 mm	0.4 mm	0.55 mm	0.4 mm ⁴
Verfügbarer Wärmewertbereich	16-20	20-24	9-27	16-22	16-22	16-27	16-34	16-24	20-24	24-35
Entstörwiderstand	Alle Typen	Alle Typen	Die meisten Typen	Alle Typen	Alle Typen	Alle Typen	Alle Typen	Alle Typen	Alle Typen	Alle Typen
Hohe Leistungsabgabe	+++	+++++	+	++	++++	++++	++++	++++	+++++	+++++
Kraftstoffeinsparung	Besser	Beste	Gut	Besser	Beste	Beste	Beste	Beste	Beste	-
Standzeit	Standard	Long life	Standard	Long life	Long life	Long life	Standard	Long life	Long life	Nur für den Rennsport

¹ Zündkerzen ohne ein 'U' in der Typbezeichnung haben keine U-Rille

² Nicht zutreffend für IU24A, IU27A, IU31A, IUF27A und IUF31A

³ Zündkerzen mit einem „Z“ in der Typbezeichnung besitzen eine konisch zulaufende Masselektrode

⁴ Außer Gleitfunkenzündkerzen

⁵ OEM-Typen, nur für bestimmte Fahrzeuge

⁶ Nadelförmige Platinspitze 0.7mm

⁷ Mit nadelförmiger Platinspitze 0.7mm erhältlich

D

Zündkerzen Montage

Empfohlenes Drehmoment und Anzugswinkel für DENSO-Zündkerzen.

1. Verwenden Sie den richtigen Schraubenschlüssel für den Sechskant der Zündkerze, und achten Sie darauf, den Isolator nicht zu beschädigen.
2. Beachten Sie beim Wechseln der Kerze, dass keine Verunreinigungen etc. von außerhalb in das Innere des Motors gelangen.
3. Bevor Sie die Zündkerzen einsetzen, reinigen Sie den Flansch im Motor und kontrollieren Sie anschließend dass der Dichtring korrekt sitzt.
4. Überprüfen Sie, ob die Zündkerzen vertikal ausgerichtet sind und ziehen Sie diese so weit wie möglich von Hand an (A+B).
5. Nutzen Sie einen Drehmomentschlüssel, um das richtige Anzugsdrehmoment zu wählen, das Sie unten stehender Tabelle entnehmen können. Wenn Sie keinen Drehmomentschlüssel zur Hand haben, nutzen Sie einen Zündkerzenschlüssel, um die Kerze mit den empfohlenen Umdrehungen festzuziehen. Für weitere Informationen zum genauen Anzugsdrehmoment nutzen Sie bitte unseren E-Katalog (C+D).

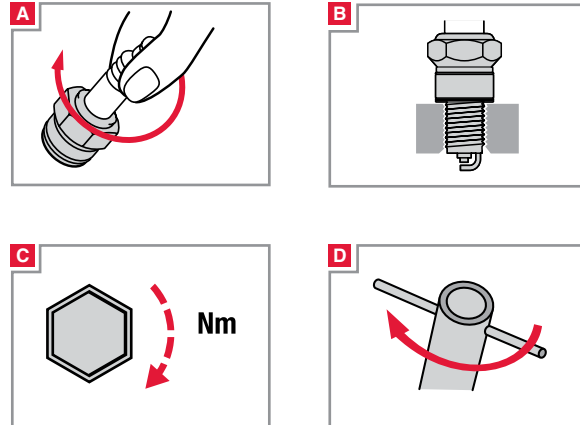

<http://www.denso-am.de/e-catalogue/>

EMPFOHLENE EINBAUDREHMOMENTE					
Gewindegröße	Empfohlenes Drehmoment	Empfohlene Drehungen			
		Neue Zündkerze	Gebrauchte Zündkerze		
Dichtring	M8 Ausführung Y	8-10 Nm	± 1 Umdrehung	± 1/12 Umdrehung	
	M10 Ausführung U, N	10-15 Nm	± 2/3 Umdrehung	± 1/12 Umdrehung	
	M10 Edelstahl-Dichtring	10-15 Nm	± 3/4 Umdrehung	± 1/12 Umdrehung	
	M12 Ausführung SXU, X, XE, XU, ZXE, ZXU	15-20 Nm	± 1/3 Umdrehung	± 1/12 Umdrehung	
	M14 Ausführung FK, J, K, KJ, P, PK, PKJ, PQ, Q, QJ, QL, S, SF, SK, SKJ, SV, SVK, VK, VKJ, W, ZT	20-25 Nm	± 1/2 Umdrehung	± 1/12 Umdrehung	
	M14 Edelstahl-Dichtring	20-25 Nm	± 2/3 Umdrehung	± 1/12 Umdrehung	
	M18 Ausführung L, M, MA, MW	30-40 Nm	± 1/4 Umdrehung	± 1/12 Umdrehung	
Konischer Sitz	M14 Ausführung PT, PTJ, T	20-30 Nm	± 1/16 Umdrehung	± 1/16 Umdrehung	
	M18 Ausführung MA	30-40 Nm	± 1/4 Umdrehung	± 1/12 Umdrehung	



Wenn Gewindeschmiermittel wie z.B. Fett verwendet wird, besteht die Gefahr, dass die Kerze, trotz Berücksichtigung des korrekten Drehmoments, zu stark angezogen wird. Dies führt zu Undichtigkeiten der Dichtung. Verwenden Sie deshalb bitte keine Gewindeschmierung.

Bitte beachten Sie die rechts in der Tabelle empfohlenen Werte bezüglich Anzugswinkel und Drehmoment. Wird die Zündkerze stärker angezogen, kann dies zu einem Schaden am Motor führen und weiterhin besteht die Gefahr, dass sich die Zündkerze aus dem Gewinde löst.

Aufbau der Zündkerze

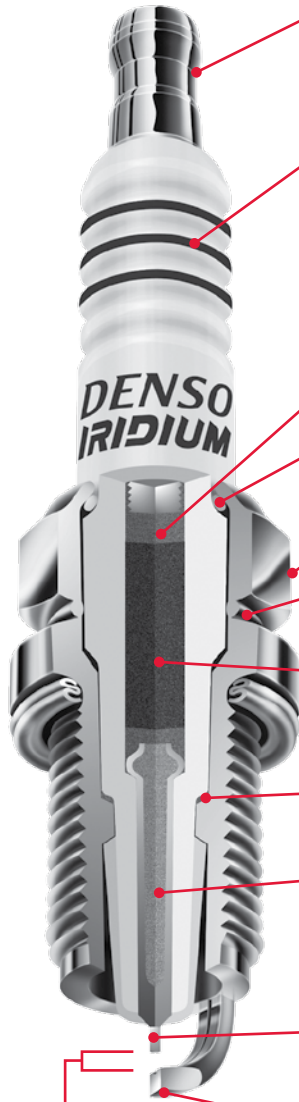

Anschluss

- > Gewinde, abnehmbar, verpresst oder fest

Keramikisolator

- > Fünffaches-Rippenprofil an der Kerzenaußenseite
- > Dies verringert Spannungsverluste und schützt vor Zündaussetzern
- > Verwendung von hochreinem Aluminium
- > Gute elektrische Isolierung, Langlebigkeit und Wärmeleitfähigkeit
- > Chemisch stabil

Ring

Spezielle Kupfer-Glas-Verkapselung

- > Sehr gute Versiegelung, Langlebigkeit und Wärmeleitfähigkeit

Dichtringgehäuse

- > Hoch korrosionsbeständige Vernickelung

Elektrisches Hitzesiegel

- > Wärmewiderstand, sorgt für gute thermische Leitfähigkeit und niedrige Wärmewertabweichungen

Widerstand

- > Mit einem 5 K Ω -Widerstand, vermindert Funkstörungen

Dichtung

Mittелеlektrode mit Kupferkern

- > Im Vergleich zu anderen Herstellern verwendet DENSO einen höheren Kupferanteil für ein besseres Wärmeverhalten
- > Von niedrigen zu hohen Drehzahlen gibt es einen starken und konstanten Funken

Mittелеlektrode

- > Die DENSO Iridium-Zündkerzen haben Mittелеlektroden mit dem weltweit kleinsten Durchmesser von 0,4 mm

Masseelektrode

- > Erhältlich mit U-Rille, was eine rückstandsfreie Verbrennung begünstigt
- > Kegelsitz erzeugt eine gleichmäßige Zündung
- > Erhältlich mit Platinspitze für eine lange Standzeit
- > Erhältlich mit nadelförmiger Spitze für eine lange Standzeit und bestes Zündverhalten

Zündstrecke

- > Die meisten DENSO Zündkerzen werden bereits mit dem richtigen, genau auf die Anwendung abgestimmten Elektrodenabstand geliefert, so dass Sie den Abstand nicht selbst einstellen müssen

Spark Plugs | Kennzeichnungstabelle

D



Iridium- / Platin- / Nickel-Zündkerzen

KENNZEICHNUNG DENSO ZÜNDKERZEN																																																														
S	W	16	E	XR	-U	11																																																								
S	K	20		PR	-A	11																																																								
S	XU	22	H	CR	-11S																																																									
Verwendetes Edelmetall	Gewindedurchmesser und Hex-Größe	Wärmebereich	Gewindebereich	Elektrodenesign	Elektrodenesign	Zündstrecke																																																								
D ... 0.7 mm Durchmesser Iridium mit nadelförmiger Elektrode aus Platin (SIP) F ... 0.55 mm Durchmesser Iridium mit nadelförmiger Elektrode aus Platin (SIP) P ... 1.1 mm Durchmesser Platin mit Platinspitze S ... 0.7 mm Durchmesser Iridium mit Platinspitze SV ... 0.4 mm Durchmesser Iridium mit Platinspitze Z ... 0.55 mm Durchmesser Iridium mit Platinspitze	C ... 12x14.0 L ... 18x22.2 (Gewindebereich: 12.7 mm) M ... 18x25.4 (Gewindebereich: 12 mm) MA ... 18x20.6 (Kegelsitz, Gewindebereich: 12 mm) MW ... 18x20.6 (Gewindebereich: 12 mm) J ... 14x20.6 (Vorgezogene Funkenanlage) K ... 14x16.0 (Miniaturzündkerze) KJ ... 14x16.0 (Miniaturzündkerze mit vorgezogener Funkenanlage) LP ... 14x20.6 (Zündkerze für LPG-Anwendungen) Q ... 14x16.0 (Miniaturzündkerze) QJ ... 14x16.0 (Miniaturzündkerze mit vorgezogener Funkenanlage) QL ... 14x20.6 (Miniaturzündkerze mit langem Zylindergehäuse) S ... 14x20.6 (Gleitfunkenkerze (für RE-Motoren)) T ... 14x16.0 (Kegelsitz) W ... 14x20.6 ... 14x19.0 (Kompakttyp) X ... 12x18.0 XE ... 12x14.0 XU ... 12x16.0 N ... 10x16.0 U ... 10x16.0 Y ... 8x13.0	<table border="1"> <tr> <th>DENSO</th> <th>NGK</th> <th>CHAMPION</th> <th>BOSCH</th> </tr> <tr> <td>4</td> <td></td> <td></td> <td></td> </tr> <tr> <td>9</td> <td>2</td> <td>18</td> <td>10</td> </tr> <tr> <td>14</td> <td>4</td> <td>16,14</td> <td>9</td> </tr> <tr> <td>16</td> <td>5</td> <td>12,11</td> <td>8</td> </tr> <tr> <td>20</td> <td>6</td> <td>10,9</td> <td>7,6</td> </tr> <tr> <td>22</td> <td>7</td> <td>8,7</td> <td>5</td> </tr> <tr> <td>24</td> <td>8</td> <td>6,63,61</td> <td>4</td> </tr> <tr> <td>27</td> <td>9</td> <td>4,59</td> <td>3</td> </tr> <tr> <td>29</td> <td>9.5</td> <td>57</td> <td></td> </tr> <tr> <td>31</td> <td>10</td> <td>55</td> <td>2</td> </tr> <tr> <td>32</td> <td>10.5</td> <td>53</td> <td></td> </tr> <tr> <td>34</td> <td>11</td> <td></td> <td></td> </tr> <tr> <td>35</td> <td>11.5</td> <td></td> <td></td> </tr> </table>	DENSO	NGK	CHAMPION	BOSCH	4				9	2	18	10	14	4	16,14	9	16	5	12,11	8	20	6	10,9	7,6	22	7	8,7	5	24	8	6,63,61	4	27	9	4,59	3	29	9.5	57		31	10	55	2	32	10.5	53		34	11			35	11.5			A ... 19.0 mm (Funkenlage: 7.0 mm) J16AR-U11 A ... 21.5 mm S29A B ... 19.0 mm (Funkenlage: 9.5 mm) J16BR-U C ... 19.0 mm (Funkenlage: 5.0 mm) KJ20CR-L11 D ... 19.0 mm (Ummantelung 2) K20DTR-S11 E (Mit Dichtring) ... 19.0 mm W16EX-U E (Mit Dichtring) ... 20.0 mm W25EBR E (Kegelsitz) ... 19.0 mm T16EPR-U F ... 12.7 mm W20FP-U FE ... 19.0 mm (Halbes Gewinde) U24FER9 G ... 19.0 mm (Ummantelung 3.5) PK20GR8 G ... 19.0 mm (Ummantelung 3) X27GPR-U H ... 26.5 mm QJ16HR-U H ... 19.0 mm (Funkenlage: 8.5 mm) K16HPR-U11 L ... 11.2 mm W14L N (Kegelsitz, Halbes Gewinde) ... 17.5 mm T20NR-U11 V (Kegelsitz) ... 25.0 mm PT16VR13 Kein ... 9.5 mm W14M-U ... 11.2 mm L14-U, M24S ... 19.0 mm SK20R11 ... 21.5 mm S29A Kein (Kegelsitz) ... 8.3 mm T20M-U ... 11.2 mm T16PR-U	A ... Doppelte Masseelektroden W22EA AY ... Doppelte Masseelektroden; gebogen J16AY B ... Dreifache Masseelektroden W22EB BG ... Dreifache Masseelektroden (ummantelt) SK20BGR11 C ... Ummantelung 1.5mm SXU22HCR11 D ... 4 Masseelektroden W27EDR D ... Vorgezogen (1.5 mm vorstehender Isolator, Funkenlage 3.5 mm) XU22HDR9 E ... Ummantelung: 2.0mm FXE20HE11 K ... Vorgezogen (1 mm vorstehender Isolator) W16EKR-S11 LM ... Kompakttyp (Hex-Größe 20.6 mm) W14LM-U M ... Länge von kurzem Isolatorkopf W27EMR-C M ... Kompakttyp (Hex-Größe 19.0 mm) W20M-U P ... Vorgezogen (1.5 mm vorstehender Isolator) W16EP-U Q ... 2 mm vorstehender Isolator, Funkenlage 3.5 mm R ... 5 kOhm Widerstand K16R-U S ... Nicht vorgezogen (0 mm vorstehender Isolator) W22ES-U S ... Iridium auf einer Seite KJ20SR11 T ... Doppelte Masseelektroden K16TR11 TM ... Doppelte Masseelektroden K22TMR11 TN ... Doppelte Masseelektroden K22TNR-S X ... Extra vorgezogen (2.5 mm vorstehender Isolator) W16EX-U	-A ... Sonderspezifikation SK16PR-A11 -B ... Sonderspezifikation K16PSR-B8 -C ... Rückgesetzte Masseelektroden W27EMR-C -D ... Kupferkern-Masseelektrode DK20PR-D13 -E ... Sonderspezifikation SK16PR-E11 -F ... Sonderspezifikation SK16PR-F11 -G ... Geschmiertes Gewinde (für Erdgasfahrzeuge) SK20R8-G -GL ... Platin-Mittelelektrode X22EPR-GL -L ... Hitzebeständige Masseelektrode K20PR-L11 -L ... 3.5 mm vorgezogener Isolator (für Motorräder) W20FP-UL -L ... Zurückgezogener Isolator (für Motorräder) W20FR-L -M ... Größere Masseelektrode SK20PR-M11S -N ... Für Yamaha und Kawasaki U27ESR-N -P ... Doppelte Platinschicht auf Masseelektrode SK20R-P11 -P ... Platinschicht auf einer Seite K16PR-P11 -R ... 10 kOhm Widerstand K22PR-UR -S ... Luftgleitfunken W20EP-S11 -S ... Edelstahlhichtring U27FER9S -T ... Für LPG-Fahrzeuge SK20HR8-T -T ... Sonderspezifikation FK20HBR11-T -TP ... Kegelförmige, einseitig platinbeschichtete Masseelektrode K20PR-TP11 -U ... Masseelektrode mit U-Rille K16PR-U -US ... Sternförmige Mittelelektrode W20M-US -V ... Nickel-Mittelelektrode mit 1.3 mm Durchmesser W27ES-V	5 ... 0.5 mm (.020") 8 ... 0.8 mm (.032") 9 ... 0.9 mm (.035") 10 ... 1.0 mm (.040") 11 ... 1.1 mm (.044") 13 ... 1.3 mm (.050") 14 ... 1.4 mm (.055") 15 ... 1.5 mm (.060") <Keine> PKW: 0.8 mm Motorrad: 0.7 mm <Ausnahmen> Zündstrecken von P16R, PQ16R, PQ20R betragen 1.1 mm
DENSO	NGK	CHAMPION	BOSCH																																																											
4																																																														
9	2	18	10																																																											
14	4	16,14	9																																																											
16	5	12,11	8																																																											
20	6	10,9	7,6																																																											
22	7	8,7	5																																																											
24	8	6,63,61	4																																																											
27	9	4,59	3																																																											
29	9.5	57																																																												
31	10	55	2																																																											
32	10.5	53																																																												
34	11																																																													
35	11.5																																																													

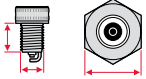

Spark Plugs | Kennzeichnungstabelle

D

IRIDIUM POWER® Reihe (Power, Tough)

KENNZEICHNUNG DENSO ZÜNDKERZEN																																															
I	U	27	A																																												
VF	KH	20																																													
																																															
Hochleistungszündkerze	Gewindedurchmesser, Gewindebereich und Hex-Größe	Wärmebereich	Elektrodenesign																																												
I 0.4 mm Iridium-Mittelelektrode V 0.4 mm Iridium-Mittelelektrode; Masseelektrode mit Platinspitze VF ... 0.4 mm Iridium-Mittelelektrode; Masseelektrode mit nadelförmiger Platinspitze (SIP)	<Gewindedurchmesser x Gewindebereich x Hex-Größe (mm)> CH ... 12x26.5x14.0 K 14x19.0x16.0 KA ... 14x19.0 (Ummantelt, neue Dreifach-Masselektrode)x16.0 KB ... 14x19.0 (Neue Dreifach-Masselektroden)x16.0 KBH ... 14x26.5 (Neue Dreifach-Masselektroden)x16.0 KD ... 14x19.0 (Ummantelt)x16.0 KH ... 14x26.5x16.0 NH ... 10x19.0 (Halbes Gewinde)x16.0 T 14x17.5 (Kegelsitz)x16.0 TF ... 14x11.2 (Kegelsitz)x16.0 TL ... 14x25.0 (Kegelsitz, langer Isolator)x16.0 TV ... 14x25.0 (Kegelsitz)x16.0 Q 14x19.0x16.0 U 10x19.0x16.0 UF ... 10x12.7x16.0 UH ... 10x19.0 (Halbes Gewinde)x16.0 W 14x19.0x20.6 WF ... 14x12.7x20.6 WM ... 14x19.0x20.6 (Kompakter Isolator) X 12x19.0x18.0 XEH ... 12x26.5 (Ummantelung 2.0)x14.0 XG ... 12x19.0 (Ummantelung 3.0)x18.0 XU ... 12x19.0x16.0 XUH ... 12x26.5x16.0 Y 8x19.0 (Halbes Gewinde)x13.0	<table border="1"> <thead> <tr> <th>DENSO</th> <th>NGK</th> <th>CHAMPION</th> <th>BOSCH</th> </tr> </thead> <tbody> <tr> <td>16</td> <td>5</td> <td>12,11</td> <td>8</td> </tr> <tr> <td>20</td> <td>6</td> <td>10,9</td> <td>7,6</td> </tr> <tr> <td>22</td> <td>7</td> <td>8,7</td> <td>5</td> </tr> <tr> <td>24</td> <td>8</td> <td>6,63,61</td> <td>4</td> </tr> <tr> <td>27</td> <td>9</td> <td>4,59</td> <td>3</td> </tr> <tr> <td>29</td> <td>9.5</td> <td>57</td> <td></td> </tr> <tr> <td>31</td> <td>10</td> <td>55</td> <td>2</td> </tr> <tr> <td>32</td> <td>10.5</td> <td>53</td> <td></td> </tr> <tr> <td>34</td> <td>11</td> <td></td> <td></td> </tr> <tr> <td>35</td> <td>11.5</td> <td></td> <td></td> </tr> </tbody> </table>	DENSO	NGK	CHAMPION	BOSCH	16	5	12,11	8	20	6	10,9	7,6	22	7	8,7	5	24	8	6,63,61	4	27	9	4,59	3	29	9.5	57		31	10	55	2	32	10.5	53		34	11			35	11.5			A Schräge Elektrode, keine U-Rille, nicht kegelförmig B Vorgezogener Isolator (1.5 mm) C Keine U-Rille D Keine U-Rille, Inconel-Masselektrode E Ummantelung: 2 mm ES ... Edelstahlchtring F Sonderspezifikation G Edelstahlchtring I Funkenlage: 4 mm Vorgezogener Isolator (1.5 mm) J Funkenlage: 5 mm K Funkenlage: 4 mm Vorgezogener Isolator (2.5 mm) L Funkenlage: 5 mm T Für LPG-Anwendungen Y 0.8 mm Zündstrecke Z Kegelförmig
DENSO	NGK	CHAMPION	BOSCH																																												
16	5	12,11	8																																												
20	6	10,9	7,6																																												
22	7	8,7	5																																												
24	8	6,63,61	4																																												
27	9	4,59	3																																												
29	9.5	57																																													
31	10	55	2																																												
32	10.5	53																																													
34	11																																														
35	11.5																																														

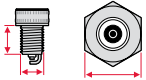
TT

KENNZEICHNUNG DENSO ZÜNDKERZEN																			
I	W	16	TT																
	XEH	20	ETT																
																			
Edelmetalltyp	Gewindedurchmesser, Gewindebereich und Hex-Größe	Wärmebereich	Elektrodenesign																
I Ø 0.4 mm Iridium mit nadelförmiger Platinspitze	<Gewindedurchmesser x Gewindebereich x Hex-Größe (mm)> K 14x19.0x16.0 KBH ... 14x26.5 (Neu: Dreifach-Elektroden)x16.0 KH ... 14x26.5x16.0 Q 14x19.0x16.0 T 14x17.5 (Kegelsitz)x16.0 TF ... 14x11.2 (Kegelsitz)x16.0 TL ... 14x25.0 (Kegelsitz, langer Isolator)x16.0 TV ... 14x25.0 (Kegelsitz)x16.0 W 14x19.0x20.6 WF ... 14x12.7x20.6 XEH ... 12x26.5 (Ummantelung 2.0)x14.0 XU ... 12x19.0x16.0 XUH ... 12x26.5x16.0	<table border="1"> <thead> <tr> <th>DENSO</th> <th>NGK</th> <th>CHAMPION</th> <th>BOSCH</th> </tr> </thead> <tbody> <tr> <td>16</td> <td>5</td> <td>12,11</td> <td>8</td> </tr> <tr> <td>20</td> <td>6</td> <td>10,9</td> <td>7,6</td> </tr> <tr> <td>22</td> <td>7</td> <td>8,7</td> <td>5</td> </tr> </tbody> </table>	DENSO	NGK	CHAMPION	BOSCH	16	5	12,11	8	20	6	10,9	7,6	22	7	8,7	5	E Ummantelung: 2 mm IXEH20ETT TT ... Nickel TT (Ø 1.5 mm Mittelelektrode, Ø 1.5 mm Masselektrode) W16TT TT ... Iridium TT (Ø 0.4 mm Mittelelektrode, Ø 0.7 mm Masselektrode) IW16TT I Funkenlage: 4 mm vorgezogener Isolator (1.5 mm) XUH20TTI
DENSO	NGK	CHAMPION	BOSCH																
16	5	12,11	8																
20	6	10,9	7,6																
22	7	8,7	5																

D

Produktgruppe - Glühkerzen

Das DENSO Glühkerzen-Programm steht für ausgezeichnete OE-Qualität und eine alle Marken umfassende Auswahl. Mit der Markteinführung bietet DENSO dem Aftermarket ein hochentwickeltes alternatives Markensortiment, das den gestiegenen Ansprüchen der modernen Dieselmotortechnik gerecht wird.

Das Produktprogramm, welches sich auf dem neuesten technischen Stand befindet, profitiert vom Know-how der DENSO Corporation als einem der weltweit führenden OE-Hersteller von Glühkerzen für die führenden Fahrzeugzulieferer der Welt. Unser nach OE-Standards entwickeltes Glühkerzen-Programm für den Aftermarket umfasst 138 Teilenummern, die mehr als 4.800 Anwendungen abdecken. Dies entspricht 98% des europäischen Fahrzeugbestands. Außerdem sind künftige Programmweiterungen geplant, um die DENSO Produktpalette stetig zu verbessern und auf dem aktuellen Stand zu halten.

Das Glühkerzen-Programm von DENSO umfasst alle aktuellen Glühkerzentechnologien, einschließlich Einzelwendel-, Doppelwendel-, keramische und Schnellstart-Glühkerzen sowie Glühkerzen mit verlängerter Nachglühzeit.

Eigenschaften der DENSO-Glühkerzen:

- > Glühkerzen in OE-Qualität, die Herstellerspezifikationen erfüllen und sogar übertreffen
- > Schnellere Aufwärmzeiten und zuverlässige Kaltstart-Leistung
- > Hohe Nachglühfähigkeit zur Reduzierung des Schadstoffausstoßes
- > Dank ausgezeichneter Modellabdeckung für fast jeden europäischen Dieselmotor geeignet
- > Mehr Anwendungsmöglichkeiten mit weniger Kerzentypen
- > Eingängiges, leicht verständliches Teilenummernsystem
- > Erfüllt die Normen ISO TS16949, ISO14001 und OHSAS 18001

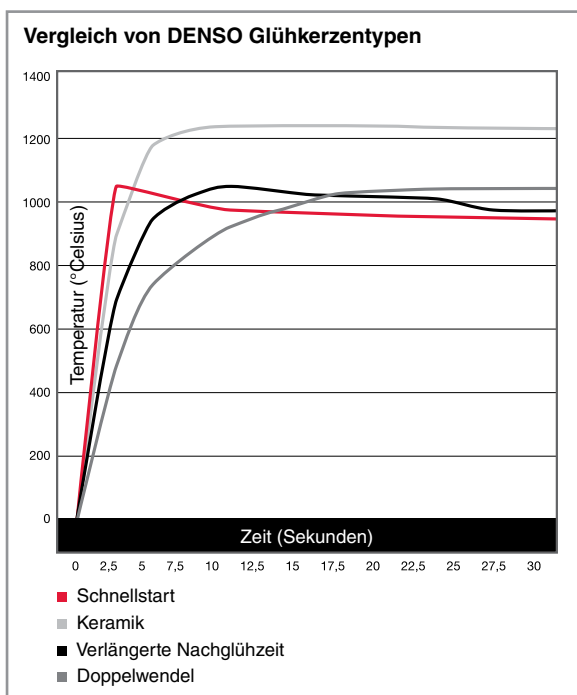

Einbau von Glühkerzen

Empfohlene Spezifikation für das Drehmoment bei DENSO-Glühkerzen:

1. Verwenden Sie für die Glühkerze und den Anschluss immer den richtigen Schraubenschlüssel.
2. Achten Sie beim Wechseln der Glühkerze darauf, dass kein Öl, Schmutz, usw. von der Außenseite der alten Glühkerze in den Zylinder gelangt.
3. Reinigen Sie vor dem Einbau den Sitz der Glühkerze am Motor.
4. Die Glühkerze muss richtig in das Gewinde eingedreht und anschließend handfest angezogen werden.
5. Verwenden Sie dann einen Drehmomentschlüssel, um die Glühkerze genau auf das in der Tabelle angegebene Drehmoment anzuziehen.

EMPFOHLENE EINBAUDREHMOMENTE		
	Gewindegröße	Empfohlenes Drehmoment
Glühkerzen	M8x1.00	8-10 Nm
	M9x1.00	8-10 Nm
	M10x1.00	10-12 Nm
	M10x1.25	10-12 Nm
	M12x1.25	15-20 Nm
	M14x1.25	20-25 Nm
Rundmutter	M18x1.50	30-40 Nm
	M4x0.7	1-1.5 Nm
	M5x0.8	3-4 Nm

! VERWENDEN SIE KEIN GEWINDESCHMIERMITTEL!
 Wenn sich ein Gewindegewindeschmiermittel wie z.B. Schmierfett am Gewinde befindet, verringert sich der Widerstand zwischen der Glühkerze und dem Zylinderkopf, was zu einem zu straffen Anziehen führt.

! Ein Anziehen über das in der Tabelle angegebene Drehmoment hinaus kann zu Schäden an der Glühkerze und am Motor führen.

! Glühkerzenausfälle werden meist durch Überspannung bzw. eine zu hohe Temperatur verursacht. Glühkerzen sind auf einen Betrieb zwischen 850 und 1100 Grad ausgelegt.
 Wenn die Spannung wegen eines defekten Relais und/oder Reglers zu lange an der Glühkerze anliegt, kann es zu einer Überhitzung dieser führen. Dies führt zum Anschwellen, Aufreißen oder Bersten der Glühkerze und damit zum sofortigen Ausfall. Es ist daher ratsam, vor dem Einbau neuer Glühkerzen die komplette elektrische Anlage zu überprüfen.
 Ein zu früher Einspritzzeitpunkt, undichte Einspritzdüsen oder Benzin im Motor lassen die Verbrennungstemperatur so hoch ansteigen, dass die Glühkerzen beschädigt werden können.

Ein fehlerhaftes Relais und ein fehlerhafter Regler können ebenfalls zu einem Glühkerzenausfall führen; daher ist es ratsam, vor dem Einbau neuer Glühkerzen das komplette System zu überprüfen.

Der Maßstab für überragende Glühkerzentechnologie

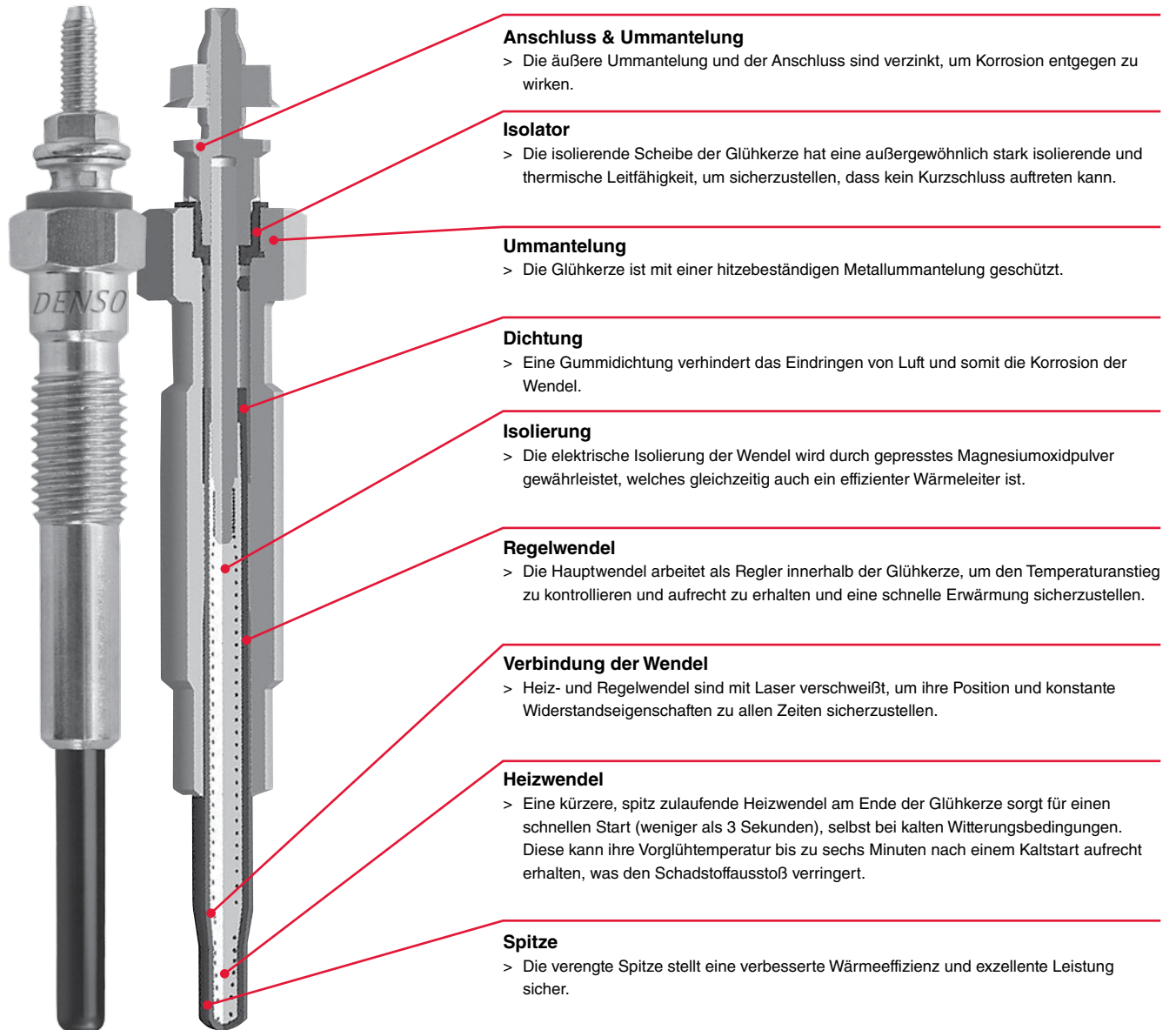

Anschluss & Ummantelung

> Die äußere Ummantelung und der Anschluss sind verzinkt, um Korrosion entgegen zu wirken.

Isolator

> Die isolierende Scheibe der Glühkerze hat eine außergewöhnlich stark isolierende und thermische Leitfähigkeit, um sicherzustellen, dass kein Kurzschluss auftreten kann.

Ummantelung

> Die Glühkerze ist mit einer hitzebeständigen Metallummantelung geschützt.

Dichtung

> Eine Gummidichtung verhindert das Eindringen von Luft und somit die Korrosion der Wendel.

Isolierung

> Die elektrische Isolierung der Wendel wird durch gepresstes Magnesiumoxidpulver gewährleistet, welches gleichzeitig auch ein effizienter Wärmeleiter ist.

Regelwendel

> Die Hauptwendel arbeitet als Regler innerhalb der Glühkerze, um den Temperaturanstieg zu kontrollieren und aufrecht zu erhalten und eine schnelle Erwärmung sicherzustellen.

Verbindung der Wendel

> Heiz- und Regelwendel sind mit Laser verschweißt, um ihre Position und konstante Widerstandseigenschaften zu allen Zeiten sicherzustellen.

Heizwendel

> Eine kürzere, spitz zulaufende Heizwendel am Ende der Glühkerze sorgt für einen schnellen Start (weniger als 3 Sekunden), selbst bei kalten Witterungsbedingungen. Diese kann ihre Vorglühtemperatur bis zu sechs Minuten nach einem Kaltstart aufrecht erhalten, was den Schadstoffausstoß verringert.

Spitze

> Die verengte Spitze stellt eine verbesserte Wärmeeffizienz und exzellente Leistung sicher.

La différence DENSO

DENSO fixe la norme de la technologie des bougies d'allumage depuis 1959. Nous développons toutes nos gammes en interne et nous les fabriquons dans nos propres usines certifiées QS 9000 et ISO 9000 réparties dans le monde – avec « zéro défaut » comme standard. Nous fournissons également cette qualité d'origine exceptionnelle au marché des pièces de rechange. Les bougies d'allumage DENSO couvrent une gamme complète de références continuellement mises à jour comprenant notamment Nickel, Platinum, Twin Tip et Iridium. Pour garantir une performance de moteur optimale, choisissez les bougies d'allumage DENSO pour toutes les applications de véhicules automobiles, motos, moteurs marins et petits moteurs.

Gamme

Nickel TT

- > Électrode centrale en alliage de nickel et électrode de masse projetée
- > Faible émissions de dioxyde de carbone (CO₂)
- > Amélioration du rendement de la combustion
- > Fonctionnement optimal du moteur même dans les conditions extrêmes
- > Bougie d'allumage performante au meilleur rapport qualité-prix

Iridium TT

- > Démarrage amélioré, plus fiable
- > Jusqu'à 20 % de performance en plus que les bougies traditionnelles en nickel
- > Durée de vie de 120 000 km
- > La technologie OEM de pointe est désormais disponible à moindre coût pour un plus grand nombre de véhicules
- > Économies de carburant

Les informations figurant dans ce catalogue sont valables à la date de publication. Consultez notre e-catalogue pour obtenir les informations les plus récentes.

Les recommandations données dans ce catalogue reposent sur les dernières informations fournies par les fabricants pour un fonctionnement dans des conditions normales. Nous n'acceptons pas de réclamations dont l'objet ne figure pas dans cette liste.

Les références croisées doivent être utilisées uniquement à titre indicatif. Dans la gamme thermique, la conception et le matériel peuvent varier d'un fabricant à l'autre. Voir la section des recommandations pour les applications spécifiques du moteur.

Les noms et/ou références des fabricants éventuellement cités sont donnés à titre de référence uniquement et n'indiquent pas la source de fabrication ni de lien quelconque avec les fabricants cités dans le cadre des activités commerciales. Pour trouver la bonne bougie d'allumage, veuillez consulter le numéro de pièce (équipementier) original sur la pièce et recherchez la référence de pièce DENSO correspondante dans le tableau croisé.

Montage direct

Nickel

- > Joint cuivre-verre favorisant la dissipation thermique
- > U-groove standard
- > Noyau de cuivre profondément inséré
- > Nickelage résistant à la chaleur
- > Bougies à multi-électrodes disponibles

Double Platinum (Longlife)

- > Démarrage amélioré, plus fiable
- > Combustion plus complète (émissions plus basses)
- > Meilleure capacité à surmonter les imperfections de réglage
- > Réponse d'accélérateur et accélération supérieures
- > Technologie éprouvée en course

Iridium Power

- > Capacité d'allumage exceptionnelle
- > Tension requise basse
- > Meilleure accélération et meilleure stabilité opérationnelle
- > Consommation de carburant moindre

Iridium Longlife, Iridium Tough

- > Capacité d'allumage exceptionnelle
- > Tension requise basse
- > Meilleure accélération et meilleure stabilité opérationnelle
- > Consommation de carburant moindre
- > Plus grande longévité

Super Ignition Plug (SIP)

- > Deux électrodes centrale et de masse ultra-fines, extrêmement résistantes
- > La plus récente des technologies des bougies d'allumage
- > Présence première monte Honda, Hyundai, Kia, Lexus, Nissan, Mitsubishi, Mazda, Subaru, Toyota et Volvo
- > Performance optimale
- > Grande longévité

Racing

Iridium Racing

- > Technologie F1
- > Accélération optimale
- > Grande fiabilité
- > Performance boostée

Range	TT Range		Direct Fit							Racing
Material	Nickel	Iridium	Nickel	Platinum	Iridium					Iridium
Type	Nickel TwinTip	Iridium TwinTip	Nickel	Platinum	Iridium OEM ⁵	Iridium Long life ⁵	Iridium Power	Iridium Tough	SIP	Iridium Racing
Rainure U	-	-	+ ¹	-	-	-	+ ²	-	-	-
Électrode de masse conique	-	Certains types	Certains types ³	-	-	-	+ ²	-	Certains types	-
Matériau d'électrode de masse	Alliage nickel	Pointe en platine ⁶	Normal	Pointe en platine	Pointe en platine	Pointe en platine	Normal	Pointe en platine ⁷	Pointe en platine ⁶	Tout platine
Électrode centrale	1.5 mm	0.55 mm	2.5 mm	1.1 mm	0.7 mm	0.4 mm	0.4 mm	0.4 mm	0.55 mm	0.4 mm ⁴
Degré thermique disponible	16-20	20-24	9-27	16-22	16-22	16-27	16-34	16-24	20-24	24-35
Résistance	Tous types	Tous types	La plupart des types	Tous types	Tous types	Tous types	Tous types	Tous types	Tous types	Tous types
Haute performance	+++	+++++	+	++	++++	++++	++++	++++	+++++	+++++
Économie de carburant	Meilleure	La meilleure	Bonne	Meilleure	La meilleure	La meilleure	La meilleure	La meilleure	La meilleure	-
Durée de vie	Standard	Longue	Standard	Longue	Longue	Longue	Standard	Longue	Longue	Course uniquement

¹ Les types de bougies ne contenant pas 'U' ne possèdent pas d'encoche en U

² Non applicable à IU24A, IU27A, IU31A, IUF27A ni IUF31A

³ Les types de bougies contenant 'Z' possèdent une électrode de masse conique

⁴ Sauf pour les types à décharge superficielle

⁵ Types équipements d'origine, uniquement pour véhicules spécifiques

⁶ Aiguille en platine 0,7 mm

⁷ Aiguille en platine 0,7 mm disponible

F

Fixation De Bougie

Couple et angle de serrage recommandés pour les bougies DENSO.

1. Utilisez la clé correspondant à l'hexagone de la bougie et veillez à ne pas endommager l'isolant.
2. Lors du remplacement, évitez que l'huile, entre autres, qui se trouve à l'extérieur de la bougie ne pénètre à l'intérieur du moteur.
3. Lors de l'insertion des bougies, nettoyez le côté moteur du flasque et fixez les bougies après s'être assuré que le joint se trouve dans le flasque.
4. Veillez à ce que les bougies soient à la verticale et serrez-les manuellement jusqu'à la butée (A+B).
5. Ensuite, utilisez une clé dynamométrique pour serrer à la valeur de couple exacte comme indiqué dans le tableau ci-dessous. Si vous ne disposez pas d'une clé dynamométrique, utilisez une clé à bougie pour serrer selon le nombre de tours recommandé. Pour tout complément d'information sur la valeur de couple absolue, veuillez consulter notre catalogue en ligne (C+D).

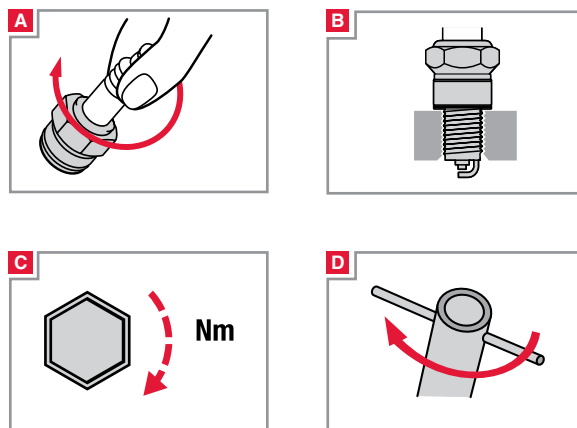

<http://www.denso-am.eu/e-catalogue/>

COUPLE RECOMMANDÉ POUR L'INSTALLATION					
Taille de filetage	Couple recommandé	Tours recommandés		Bougie neuve	Ancienne bougie
Joint	M8 Type Y	8-10 Nm	± 1 tour	± 1/12 tour	
	M10 Type U, N	10-15 Nm	± 2/3 tour	± 1/12 tour	
	M10 Joint en acier inoxydable	10-15 Nm	± 3/4 tour	± 1/12 tour	
	M12 Type SXU, X, XE, XU, ZXE, ZXU	15-20 Nm	± 1/3 tour	± 1/12 tour	
	M14 Type FK, J, K, KJ, P, PK, PKJ, PQ, Q, QJ, QL, S, SF, SK, SKJ, SV, SVK, VK, VKJ, W, ZT	20-25 Nm	± 1/2 tour	± 1/12 tour	
	M14 Joint en acier inoxydable	20-25 Nm	± 2/3 tour	± 1/12 tour	
	M18 Type L, M, MA, MW	30-40 Nm	± 1/4 tour	± 1/12 tour	
Siège conique	M14 Type PT, PTJ, T	20-30 Nm	± 1/16 tour	± 1/16 tour	
	M18 MA type	30-40 Nm	± 1/4 tour	± 1/12 tour	



Si le filetage est recouvert d'un lubrifiant à fil comme de la graisse, évitez de serrer au couple recommandé car cela peut provoquer une fuite. Ne pas utiliser un lubrifiant à fil.

Le serrage au-delà de l'angle de serrage et du couple indiqués à droite peut endommager le moteur et entraîner le retrait de la bougie au niveau du filetage.

F

Caractéristiques de la bougie

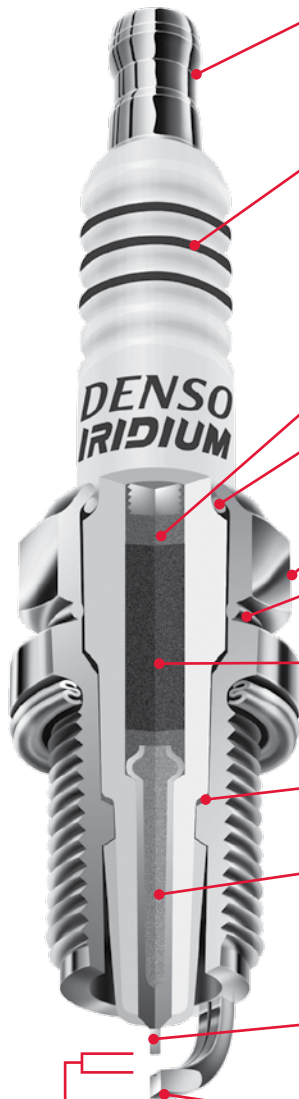

Borne

- > Filetage, amovible, serti ou solide

Isolant en céramique

- > Le motif à cinq nervures est visible sur toute la surface
- > Il réduit les pertes de tension et évite les étincelles ratées
- > Alumine de haute pureté utilisée
- > Bonnes isolation électrique, durabilité et conductivité thermique
- > Stabilité chimique

Segment

Scellement spécial cuivre-verre

- > Bonnes étanchéité à l'air, durabilité et conductivité thermique.

Gaine

- > Revêtement en nickel anti-corrosion

Joint thermique électrique

- > Résistance à la chaleur, bonne herméticité et faible variation dans la plage thermique.

Résistance

- > Avec une résistance de 5 K Ω , le bruit radioélectrique est réduit.

Conditionnement

Électrode centrale à noyau en cuivre

- > Par rapport à d'autres fabricants, DENSO utilise des concentrations de cuivre supérieures pour de meilleures propriétés thermiques.
- > En vitesse basse ou élevée, l'étincelle est franche et soutenue.

Électrode centrale

- > Avec seulement 0,4 mm, le diamètre de l'électrode centrale des bougies à l'iridium de DENSO est le petit du monde

Électrode de masse

- > Disponible avec une rainure en U pour une combustion plus complète
- > Forme conique pour un allumage soutenu.
- > Disponible avec une pointe en platine pour une longue durée de vie
- > Disponible avec une pointe d'aiguille pour une grande longévité et une meilleure inflammabilité

Écartement des pointes

- > La plupart des bougies d'allumage DENSO sont fournies avec un écartement pré réglé pour s'adapter à votre application. Vous ne devez donc pas écarter l'électrode vous-même.

Spark Plugs | Tableau d'identification

F



Bougies Iridium / Platinum / Nickel

IDENTIFICATION DES BOUGIES D'ALLUMAGE DENSO																																																														
	W	16	E	XR	-U	11																																																								
S	K	20		PR	-A	11																																																								
S	XU	22	H	CR	-11S																																																									
Type de métal précieux	Diamètre de filetage et taille Hex	Valeur thermique			Portée	Forme (Type)	Forme (Type)	Écartement																																																						
D ... 0.7 mm de diamètre Iridium avec aiguille platine (SIP) F ... 0.55 mm de diamètre Iridium avec aiguille platine (SIP) P ... 1.1 mm de diamètre Platine avec pointe platine S ... 0.7 mm de diamètre Iridium avec pointe platine SV ... 0.4 mm de diamètre Iridium avec pointe platine Z ... 0.55 mm de diamètre Iridium avec pointe platine	C 12x14.0 L 18x22.2 (Portée: 12.7 mm) M 18x25.4 (Portée: 12 mm) MA 18x20.6 (Siège conique, Portée: 12 mm) MW 18x20.6 (Portée: 12 mm) J 14x20.6 (Bougie projetée) K 14x16.0 (Bougie miniature) KJ 14x16.0 (Bougie projetée miniature) LP 14x20.6 (Bougie pour applications GPL) Q 14x16.0 (Bougie miniature) QJ 14x16.0 (Bougie projetée miniature) QL 14x20.6 (Bougie miniature à boîtier cylindrique long) S 14x20.6 (Bougies avec écartement de surface pour moteurs RE) T 14x16.0 (Siège conique) W 14x20.6 14x19.0 (Type compact) X 12x18.0 XE 12x14.0 XU 12x16.0 N 10x16.0 U 10x16.0 Y 8x13.0	<table border="1"> <tr> <th>DENSO</th> <th>NGK</th> <th>CHAMPION</th> <th>BOSCH</th> </tr> <tr> <td>4</td> <td></td> <td></td> <td></td> </tr> <tr> <td>9</td> <td>2</td> <td>18</td> <td>10</td> </tr> <tr> <td>14</td> <td>4</td> <td>16,14</td> <td>9</td> </tr> <tr> <td>16</td> <td>5</td> <td>12,11</td> <td>8</td> </tr> <tr> <td>20</td> <td>6</td> <td>10,9</td> <td>7,6</td> </tr> <tr> <td>22</td> <td>7</td> <td>8,7</td> <td>5</td> </tr> <tr> <td>24</td> <td>8</td> <td>6,63,61</td> <td>4</td> </tr> <tr> <td>27</td> <td>9</td> <td>4,59</td> <td>3</td> </tr> <tr> <td>29</td> <td>9.5</td> <td>57</td> <td></td> </tr> <tr> <td>31</td> <td>10</td> <td>55</td> <td>2</td> </tr> <tr> <td>32</td> <td>10.5</td> <td>53</td> <td></td> </tr> <tr> <td>34</td> <td>11</td> <td></td> <td></td> </tr> <tr> <td>35</td> <td>11.5</td> <td></td> <td></td> </tr> </table>	DENSO	NGK	CHAMPION	BOSCH	4				9	2	18	10	14	4	16,14	9	16	5	12,11	8	20	6	10,9	7,6	22	7	8,7	5	24	8	6,63,61	4	27	9	4,59	3	29	9.5	57		31	10	55	2	32	10.5	53		34	11			35	11.5			A 19.0 mm (Position de l'étincelle: 7.0 mm) J16AR-U11 A 21.5 mm S29A B 19.0 mm (Position de l'étincelle: 9.5 mm) J16BR-U C 19.0 mm (Position de l'étincelle: 5.0 mm) KJ20CR-L11 D 19.0 mm (Blindage 2) K20DTR-S11 E (Avec joint) 19.0 mm W16EX-U E (Avec joint) 20.0 mm W25EBR E (Siège conique) 19.0 mm T16EPR-U F 12.7 mm W20FP-U FE 19.0 mm (Semi-filetage) U24FER9 G 19.0 mm (Blindage 3.5) PK20GR8 G 19.0 mm (Blindage 3) X27GPR-U H 26.5 mm QJ16HR-U H 19.0 mm (Position de l'étincelle: 8.5 mm) K16HPR-U11 L 11.2 mm W14L N (Siège conique, Semi-filetage) 17.5 mm T20NR-U11 V (Siège conique) 25.0 mm PT16VR13 Aucune 9.5 mm W14M-U 11.2 mm L14-U, M24S 19.0 mm SK20R11 21.5 mm S29A Aucune (Siège conique) 8.3 mm T20M-U 11.2 mm T16PR-U	A Double électrode de masse W22EA AY .. Double électrode de masse à forme courbée J16AY B ... Triple électrode de masse W22EB BG ... Triple électrode de masse (blindage) SK20BGR11 C ... Blindage 1.5mm SXU22HCR11 D ... 4 électrodes de masse W27EDR D ... Projetée (1.5 mm de projection, position de l'étincelle 3.5 mm) XU22HDR9 E Blindage: 2.0mm FXE20HE11 K ... Projetée (1 mm de projection) W16EKR-S11 LM .. Type compact (Hex 20.6 mm) W14LM-U M Longueur de la tête de l'isolant raccourcie W27EMR-C M Type compact (Hex 19.0 mm) W20M-U P Projetée (1.5 mm de projection) W16EP-U Q Projetée 2 mm, position de l'étincelle 3.5 mm R Résistance de 5 kOhm K16R-U S Non-projetée (0 mm de projection) W22ES-U S Iridium sur un côté KJ20SR11 T Double électrode de masse K16TR11 TM .. Double électrode de masse K22TMR11 TN .. Double électrode de masse K22TNR-S X Complètement projetée (2.5 mm de projection) W16EX-U	-A ... Spécification spéciale SK16PR-A11 -B ... Spécification spéciale K16PSR-B8 -C ... Électrodes de masse fluxées W27EMR-C -D ... Électrode de masse à noyau en cuivre DK20PR-D13 -E ... Spécification spéciale SK16PR-E11 -F ... Spécification spéciale SK16PR-F11 -G ... Graisse appliquée aux filetages pour GNC SK20R8-G -GL .. Électrode centrale en platine X22EPR-GL -L ... Électrode centrale résistante à la chaleur K20PR-L11 -L ... Isolant projeté de 3.5 mm pour motos W20FP-U -L ... Isolant rétracté pour motos W20FR-L -M .. Électrode de masse plus grande SK20PR-M11S -N ... Pour Yamaha et Kawasaki U27ESR-N -P ... Électrode de masse double platine SK20R-P11 -P ... Bougie en platine à un côté K16PR-P11 -R ... Résistance de 10K ohm K22PR-UR -S ... Type décharge à écartement semi-surface W20EP-S11 -S ... Joint en acier inoxydable U27FER9S -T ... Pour GPL SK20HR8-T -T ... Spécification spéciale FK20HBR11-T -TP .. Bougie platine sur un côté, électrode de masse conique K20PR-TP11 -U ... Électrode de masse avec rainure en U K16PR-U -US .. Électrode centrale en forme d'étoile W20M-US -V ... 1.3 mm de diamètre, électrode à noyau de nickel W27ES-V	5 0.5 mm (.020") 8 0.8 mm (.032") 9 0.9 mm (.035") 10 1.0 mm (.040") 11 1.1 mm (.044") 13 1.3 mm (.050") 14 1.4 mm (.055") 15 1.5 mm (.060") <aucun> Voitures: 0.8 mm M/C: 0.7 mm <Exceptions> : P16R, PQ16R, PQ20R sont de 1.1 mm
	DENSO	NGK	CHAMPION	BOSCH																																																										
	4																																																													
	9	2	18	10																																																										
	14	4	16,14	9																																																										
	16	5	12,11	8																																																										
	20	6	10,9	7,6																																																										
	22	7	8,7	5																																																										
	24	8	6,63,61	4																																																										
	27	9	4,59	3																																																										
	29	9.5	57																																																											
	31	10	55	2																																																										
	32	10.5	53																																																											
	34	11																																																												
	35	11.5																																																												

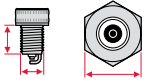

Spark Plugs | Tableau d'identification

F

IRIDIUM POWER® Séries Iridium Power (Power, Tough)

IDENTIFICATION DES BOUGIES D'ALLUMAGE DENSO																																															
I	U	27	A																																												
VF	KH	20																																													
																																															
Bougie hautes performances	Diamètre de filetage, portée et taille hex	Valeur thermique	Forme (type)																																												
I 0.4 mm de diamètre en iridium V 0.4 mm de diamètre en iridium avec pointe en platine VF ... 0.4 mm de diamètre en iridium avec aiguille type pointe en platine (SIP)	<Diamètre de filetage x portée x taille Hex (mm)> CH ... 12x26.5x14.0 K 14x19.0x16.0 KA ... 14x19.0 (Nouvelle triple électrode blindée)x16.0 KB ... 14x19.0 (Nouvelle triple électrode)x16.0 KBH ... 14x26.5 (Nouvelle triple électrode)x16.0 KD ... 14x19.0 (Blindée)x16.0 KH ... 14x26.5x16.0 NH ... 10x19.0 (Semi-filetage)x16.0 T 14x17.5 (Siège conique)x16.0 TF ... 14x11.2 (Siège conique)x16.0 TL ... 14x25.0 (Siège conique, isolant long)x16.0 TV ... 14x25.0 (Siège conique)x16.0 Q 14x19.0x16.0 U 10x19.0x16.0 UF ... 10x12.7x16.0 UH ... 10x19.0 (Semi-filetage)x16.0 W ... 14x19.0x20.6 WF ... 14x12.7x20.6 WM ... 14x19.0x20.6 (Isolant compact) X 12x19.0x18.0 XEH ... 12x26.5 (Blindage 2.0)x14.0 XG ... 12x19.0 (Blindage 3.0)x18.0 XU ... 12x19.0x16.0 XUH ... 12x26.5x16.0 Y 8x19.0 (Semi-filetage)x13.0	<table border="1"> <thead> <tr> <th>DENSO</th> <th>NGK</th> <th>CHAMPION</th> <th>BOSCH</th> </tr> </thead> <tbody> <tr> <td>16</td> <td>5</td> <td>12,11</td> <td>8</td> </tr> <tr> <td>20</td> <td>6</td> <td>10,9</td> <td>7,6</td> </tr> <tr> <td>22</td> <td>7</td> <td>8,7</td> <td>5</td> </tr> <tr> <td>24</td> <td>8</td> <td>6,63,61</td> <td>4</td> </tr> <tr> <td>27</td> <td>9</td> <td>4,59</td> <td>3</td> </tr> <tr> <td>29</td> <td>9.5</td> <td>57</td> <td></td> </tr> <tr> <td>31</td> <td>10</td> <td>55</td> <td>2</td> </tr> <tr> <td>32</td> <td>10.5</td> <td>53</td> <td></td> </tr> <tr> <td>34</td> <td>11</td> <td></td> <td></td> </tr> <tr> <td>35</td> <td>11.5</td> <td></td> <td></td> </tr> </tbody> </table>	DENSO	NGK	CHAMPION	BOSCH	16	5	12,11	8	20	6	10,9	7,6	22	7	8,7	5	24	8	6,63,61	4	27	9	4,59	3	29	9.5	57		31	10	55	2	32	10.5	53		34	11			35	11.5			A Électrode inclinée, sans rainure en U, sans électrode conique B Isolant projeté (1.5 mm) C Sans rainure en U D Électrode de masse Inconel sans rainure en U E Blindage : 2 mm ES ... Joint en acier inoxydable F Spécification spéciale G Joint en acier inoxydable I Position de l'étincelle : 4 mm Isolant projeté (1.5 mm) J Position de l'étincelle : 5 mm K Position de l'étincelle : 4 mm Isolant projeté (2.5mm) L Position de l'étincelle : 5 mm T Pour applications GPL Y Écartement de 0,8 mm Z Électrode conique
DENSO	NGK	CHAMPION	BOSCH																																												
16	5	12,11	8																																												
20	6	10,9	7,6																																												
22	7	8,7	5																																												
24	8	6,63,61	4																																												
27	9	4,59	3																																												
29	9.5	57																																													
31	10	55	2																																												
32	10.5	53																																													
34	11																																														
35	11.5																																														

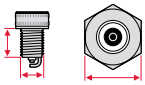
TT

IDENTIFICATION DES BOUGIES D'ALLUMAGE DENSO																			
I	W	16	TT																
	XEH	20	ETT																
																			
Type de métal précieux	Diamètre de filetage, portée et taille hex	Valeur thermique	Forme (type)																
I 0,4 mm de diamètre Iridium avec pointe platine	<Diamètre de filetage x portée x taille Hex (mm)> K 14x19.0x16.0 KBH ... 14x26.5 (nouvelle triple électrode)x16.0 KH ... 14x26.5x16.0 Q 14x19.0x16.0 T 14x17.5 (siège conique)x16.0 TF ... 14x11.2 (siège conique)x16.0 TL ... 14x25.0 (siège conique, isolant long)x16.0 TV ... 14x25.0 (siège conique)x16.0 W ... 14x19.0x20.6 WF ... 14x12.7x20.6 XEH ... 12x26.5 (blindage 2.0)x14.0 XU ... 12x19.0x16.0 XUH ... 12x26.5x16.0	<table border="1"> <thead> <tr> <th>DENSO</th> <th>NGK</th> <th>CHAMPION</th> <th>BOSCH</th> </tr> </thead> <tbody> <tr> <td>16</td> <td>5</td> <td>12,11</td> <td>8</td> </tr> <tr> <td>20</td> <td>6</td> <td>10,9</td> <td>7,6</td> </tr> <tr> <td>22</td> <td>7</td> <td>8,7</td> <td>5</td> </tr> </tbody> </table>	DENSO	NGK	CHAMPION	BOSCH	16	5	12,11	8	20	6	10,9	7,6	22	7	8,7	5	E Blindage: 2 mm IXEH20ETT TT ... Nickel TT (1,5 mm de diamètre électrode centrale, 1,5 mm de diamètre électrode de masse) W16TT TT ... Iridium TT (0,4 mm de diamètre électrode centrale, 0,7 mm de diamètre électrode de masse) IW16TT I Position de l'étincelle : 4 mm Isolant projeté (1,5 mm) XUH20TTI
DENSO	NGK	CHAMPION	BOSCH																
16	5	12,11	8																
20	6	10,9	7,6																
22	7	8,7	5																

Gamme de bougies de préchauffage

Le programme de bougies de préchauffage DENSO est une innovation universelle conforme aux produits première-monte. Ce programme a été lancé pour fournir à nos clients un choix alternatif en raison des besoins croissants dans le domaine du Diesel.

Ce produit de pointe bénéficie de la renommée DENSO Corporation en tant que principal fabricant de bougies de préchauffage d'origine pour les plus grands constructeurs automobiles du monde. Conçu en conformité avec les normes OE, notre programme de bougies de préchauffage pour le marché des pièces de rechange comprend 138 numéros de pièces, couvrant plus de 4.800 applications, équivalent à 98% des parc automobiles européen. Des extensions permanentes sont prévues de façon à améliorer et à mettre la gamme à jour.

Le programme de bougies de préchauffage DENSO englobe toutes les technologies actuelles, y compris le simple et double bobinages, le postchauffage ainsi, les bougies céramiques et les chauffages instantané.

Les bougies de préchauffage DENSO présentent:

- > Des bougies de préchauffage de qualité première monte qui répondent aux cahiers des charges des constructeurs ou en dépassent même les exigences
- > Mise en température accélérée et démarrage à froid fiable
- > Températures de post-chauffage prolongées, d'où émissions réduites
- > Bougies à filament simple, à double filament, à post-chauffage prolongé et bougies en céramique
- > Le champ d'application étant très vaste, la compatibilité avec la plupart des moteurs diesel rencontrés en Europe est assurée
- > Davantage d'applications couvertes par un nombre de références pièces moindre
- > Système de numérotation de pièces facile à utiliser
- > Conforme aux normes ISO TS16949, ISO14001 et OHSAS 18001

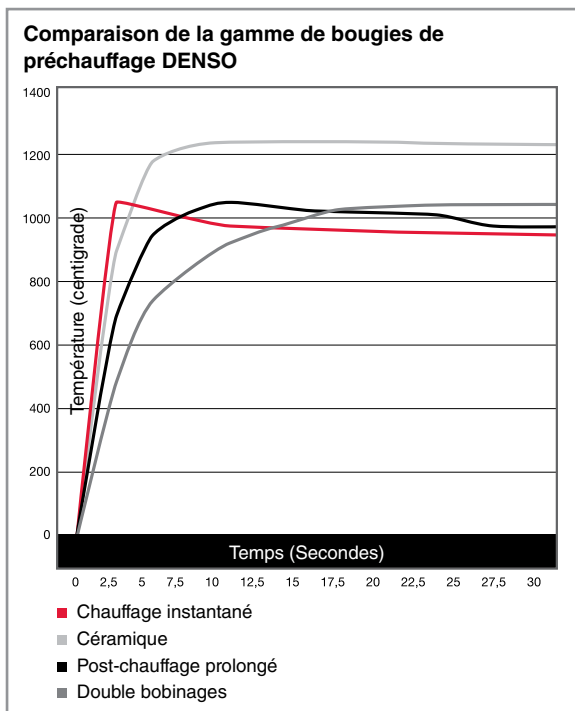

Comment installer une bougie de préchauffage

Couple recommandé pour les bougies de préchauffage DENSO :

1. Utilisez la clé correcte pour la bougie de préchauffage et la borne.
2. Lorsque vous remplacez les bougies de préchauffage, assurez-vous que l'huile, la saleté, etc. se trouvant à l'extérieur de la bougie de préchauffage démontée ne pénètrent pas dans le cylindre.
3. Lorsque vous montez la bougie de préchauffage, nettoyez le côté moteur du flasque et assurez-vous que la bougie de préchauffage est bien en ligne avec le filetage de la culasse.
4. Assurez-vous que la bougie est bien placée et serrez-la à la main jusqu'à ce qu'elle soit bloquée.
5. Ensuite, utilisez une clé dynamométrique pour la serrer avec précision au couple indiqué sur le graphique ci-dessous.

COUPLE RECOMMANDÉ POUR L'INSTALLATION		
Dimension de filetage	Couple recommandé	
Bougies de préchauffage	M8x1.00	8-10 Nm
	M9x1.00	8-10 Nm
	M10x1.00	10-12 Nm
	M10x1.25	10-12 Nm
	M12x1.25	15-20 Nm
	M14x1.25	20-25 Nm
Plot	M18x1.50	30-40 Nm
	M4x0.7	1-1.5 Nm
	M5x0.8	3-4 Nm

⚠ NE PAS UTILISER DE LUBRIFIANT POUR FILETAGES ! Si on applique un lubrifiant pour filetages (huile de graissage, par ex.) sur le filetage, la résistance entre la bougie de préchauffage et la culasse diminuera > ce qui entraînera un serrage trop important.

⚠ Un serrage supérieur aux couples indiqués dans le tableau cidessous peut endommager la bougie de préchauffage et le moteur.

⚠ Les défaillances de bougies de préchauffage sont dues le plus souvent à une tension et /ou à une chaleur excessive. Les bougies de préchauffage sont conçues pour fonctionner à une température entre 850 et 1 100 degrés.

Lorsque le courant électrique à la bougie de préchauffage est maintenu trop longtemps, en raison d'un relais et/ou d'un contrôleur défectueux, il peut provoquer une surchauffe qui fera gonfler, fendre ou éclater la bougie de préchauffage, causant une défaillance immédiate. Il est par conséquent conseillé de contrôler l'ensemble système électrique avant de remplacer les bougies d'allumage.

Un calage de l'injection trop en avance, des injecteurs qui fuient ou de l'essence dans votre moteur causera une montée excessive de la température de combustion, endommageant les bougies de préchauffage. **Un dispositif de contrôle ou un relai défectueux peuvent aussi occasionner la défaillance de la bougie.** Il est donc conseillé de vérifier le système complètement avant l'installation de nouvelles bougies de préchauffage.

F

Le modèle d'une technologie supérieure de bougies de préchauffage

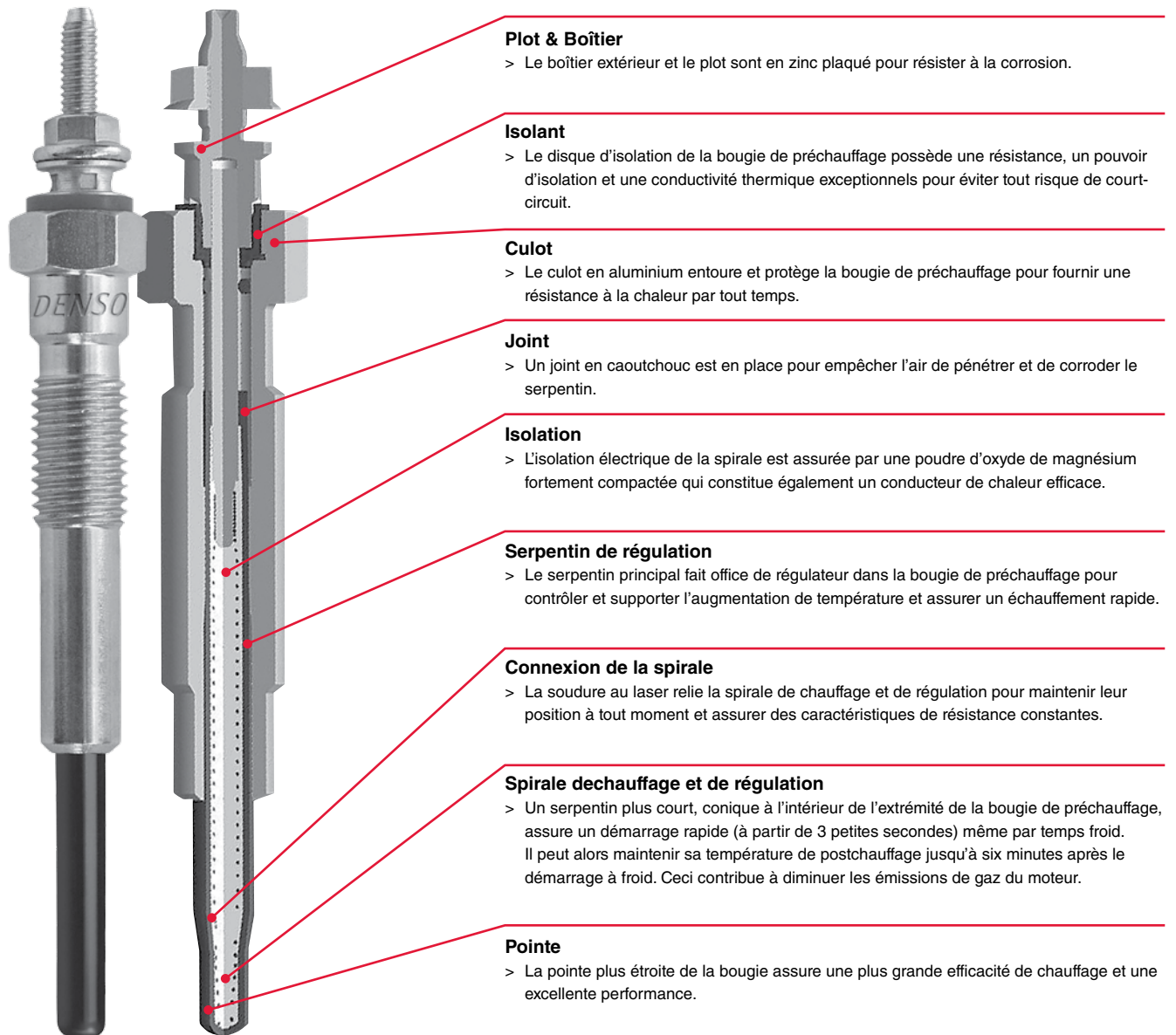

Plot & Boîtier

> Le boîtier extérieur et le plot sont en zinc plaqué pour résister à la corrosion.

Isolant

> Le disque d'isolation de la bougie de préchauffage possède une résistance, un pouvoir d'isolation et une conductivité thermique exceptionnels pour éviter tout risque de court-circuit.

Culot

> Le culot en aluminium entoure et protège la bougie de préchauffage pour fournir une résistance à la chaleur par tout temps.

Joint

> Un joint en caoutchouc est en place pour empêcher l'air de pénétrer et de corroder le serpentin.

Isolation

> L'isolation électrique de la spirale est assurée par une poudre d'oxyde de magnésium fortement compactée qui constitue également un conducteur de chaleur efficace.

Serpentin de régulation

> Le serpentin principal fait office de régulateur dans la bougie de préchauffage pour contrôler et supporter l'augmentation de température et assurer un échauffement rapide.

Connexion de la spirale

> La soudure au laser relie la spirale de chauffage et de régulation pour maintenir leur position à tout moment et assurer des caractéristiques de résistance constantes.

Spirale de chauffage et de régulation

> Un serpentin plus court, conique à l'intérieur de l'extrémité de la bougie de préchauffage, assure un démarrage rapide (à partir de 3 petites secondes) même par temps froid. Il peut alors maintenir sa température de postchauffage jusqu'à six minutes après le démarrage à froid. Ceci contribue à diminuer les émissions de gaz du moteur.

Pointe

> La pointe plus étroite de la bougie assure une plus grande efficacité de chauffage et une excellente performance.

DENSO: La diferencia

DENSO ha ido estableciendo la pauta en la tecnología de las bujías de encendido desde 1959. Desarrollamos todas nuestras gamas internamente, y las fabricamos en nuestras propias fábricas repartidas en todo el mundo bajo certificaciones QS 9000 y ISO 9000, con "cero defecto" como norma. Y aportamos también la sobresaliente calidad del equipo original al mercado de la posventa. Con la inclusión de las series Níquel, Platinum, Twin Tip e Iridium, las bujías de encendido DENSO abarcan una gama completa de referencias en continua actualización. Con la garantía de unas prestaciones óptimas del motor, elija bujías de encendido DENSO cualquiera que sea la aplicación para automóvil, motocicleta, embarcación o pequeño motor.

Gama

Twin Tip (TT)

Níquel TT

- > Electrodo central de aleación de níquel y electrodo de masa de doble punta.
- > Bajas emisiones de dióxido de carbono.
- > Economía de combustible mejorada.
- > Funcionamiento regular del motor, incluso en condiciones extremas.
- > Bujía de encendido de altas prestaciones con la mejor relación calidad-precio.

Iridium TT

- > Mejor arranque con mayor fiabilidad
- > Una mejora en el rendimiento de hasta el 20 % en comparación con las bujías de níquel tradicionales
- > Vida útil de 120 000 km
- > Tecnología OEM premium disponible ahora a un precio reducido para una mayor variedad de vehículos
- > Ahorro de combustible

La información de este catálogo es válida en la fecha de publicación. Consulte nuestro catálogo electrónico para obtener la información más actualizada.

Las recomendaciones de este catálogo se basan en la información más reciente de los fabricantes para el funcionamiento en condiciones normales. No aceptamos demandas judiciales derivadas del contenido de este listado.

La información de cruce de referencias debe utilizarse únicamente como una orientación. Las diferencias de diseño y de material entre fabricantes pueden variar en el rango térmico. Consulte el apartado de recomendaciones para las aplicaciones de motores específicos.

En los casos en los que se indican los nombres o los números de los fabricantes, estos se proporcionan únicamente como referencia y no indican la fuente de fabricación ni ninguna conexión en el transcurso de las operaciones comerciales con dichos fabricantes. Para encontrar la bujía adecuada, consulte el número de pieza original (OEM) en la pieza y busque el número de pieza de DENSO correspondiente en la tabla de cruce de referencias.

Montaje directo

Nickel

- > Sellador de cobre-vidrio que facilita la disipación del calor
- > U-groove estándar
- > Núcleo de cobre insertado en profundidad
- > Niquelado resistente al calor
- > Bujías con varios electrodos de masa disponibles

Double Platinum (Longlife)

- > Mejor arranque con mayor fiabilidad
- > Combustión más completa – menores emisiones
- > Mayor capacidad para eliminar irregularidades de marcha
- > Respuesta superior de la aceleración
- > RTecnología demostrada en competición

Iridium Power

- > Excelente encendido
- > Trabaja con baja tensión
- > Mejor respuesta a la aceleración y regularidad de marcha
- > Menor consumo de combustible

Iridium Longlife, Iridium Tough

- > Excelente encendido
- > Trabaja con baja tensión
- > Mejor respuesta a la aceleración y regularidad de marcha
- > Menor consumo de combustible
- > Mayor duración

Super Ignition Plug (SIP)

- > Electrodos central y de masa ultradelgados y de alta duración.
- > La última tecnología de las bujías de encendido.
- > Primeros equipos en Honda, Hyundai, Kia, Lexus, Nissan, Mitsubishi, Mazda, Subaru, Toyota y Volvo.
- > Altas prestaciones.
- > Larga vida.

Competición

Iridium Racing

- > Tecnología de F1
- > Aceleración extrema
- > Alta fiabilidad
- > Incremento de las prestaciones

DENSO: La diferencia

Range	TT Range		Direct Fit							Racing
Material	Nickel	Iridium	Nickel	Platinum	Iridium					Iridium
Type	Nickel Twin Tip	Iridium Twin Tip	Nickel	Platinum	Iridium OEM ⁵	Iridium Long life ⁵	Iridium Power	Iridium Tough	SIP	Iridium Racing
Ranura en U	-	-	+ ¹	-	-	-	+ ²	-	-	-
Electrodo de masa en punta	-	Algunos tipos	Algunos tipos ³	-	-	-	+ ²	-	Algunos tipos	-
Material del electrodo de masa	Aleación de níquel	Punta de platino ⁶	Normal	Punta de platino	Punta de platino	Punta de platino	Normal	Punta de platino ⁷	Punta de platino ⁶	Platino integral
Electrodo central	1.5 mm	0.55 mm	2.5 mm	1.1 mm	0.7 mm	0.4 mm	0.4 mm	0.4 mm	0.55 mm	0.4 mm ⁴
Grados térmicos disponibles	16-20	20-24	9-27	16-22	16-22	16-27	16-34	16-24	20-24	24-35
Resistencia	Todos los tipos	Todos los tipos	Mayoría de tipos	Todos los tipos	Todos los tipos	Todos los tipos	Todos los tipos	Todos los tipos	Todos los tipos	Todos los tipos
Altas prestaciones	+++	+++++	+	++	++++	++++	++++	++++	+++++	+++++
Ahorro de combustible	Muy bueno	Excelente	Bueno	Muy bueno	Excelente	Excelente	Excelente	Excelente	Excelente	-
Duración de vida	Standard	Larga vida	Standard	Larga vida	Larga vida	Larga vida	Standard	Larga vida	Larga vida	Sólo competición

¹ Los tipos de bujía sin una "U" en la designación no tienen ranura en U.

² No es aplicable a IU24A, IU27A, IU31A, IUF27A y IUF31A.

³ Los tipos de bujía con una "Z" en la designación tienen un electrodo de masa en punta.

⁴ Excepto para tipos de descarga superficial.

⁵ Tipos OEM, sólo para vehículos específicos.

⁶ Needle Platinum 0.7mm

⁷ Needle Platinum 0.7mm available

E

Montaje De Las Bujías

Par y ángulo de apriete recomendados para las bujías DENSO

1. Utilice la llave apropiada para el hexágono en la bujía y procure no dañar el aislante.
2. Al cambiar la bujía, asegúrese de que el aceite u otra sustancia que se encuentre en el exterior de la bujía no penetre en el interior del motor.
3. Al montar las bujías, limpie el lado del motor de la abrazadera e inserte las bujías tras cerciorarse de que la junta se encuentra en la abrazadera.
4. Asegúrese de que las bujías queden en posición vertical y apriételas manualmente hasta que ya no puedan seguir apretándose (A+B).
5. A continuación, utilice una llave dinamométrica para obtener el valor de par de apriete preciso como se muestra en la tabla siguiente. Si no dispone de una llave dinamométrica, utilice una llave para bujías para apretar las vueltas recomendadas. Para obtener más información acerca del valor de par de apriete absoluto, visite nuestro catálogo electrónico (C+D).

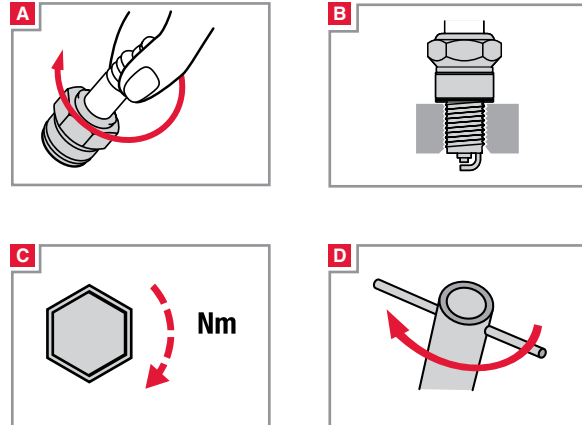

<http://www.denso-am.eu/e-catalogue/>

PAR DE MONTAJE RECOMENDADO					
Tamaño de rosca	Par recomendado	Giros recomendados		Bujía nueva	Bujía usada
Junta	M8 Tipo Y	8-10 Nm	± 1 giro	± 1/12 giro	
	M10 Tipo U, N	10-15 Nm	± 2/3 giro	± 1/12 giro	
	M10 Junta de acero inoxidable	10-15 Nm	± 3/4 giro	± 1/12 giro	
	M12 Tipos SXU, X, XE, XU, ZXE, ZXU	15-20 Nm	± 1/3 giro	± 1/12 giro	
	M14 Tipos FK, J, K, KJ, P, PK, PKJ, PQ, Q, QJ, QL, S, SF, SK, SKJ, SV, SVK, VK, VKJ, W, ZT	20-25 Nm	± 1/2 giro	± 1/12 giro	
	M14 Junta de acero inoxidable	20-25 N	± 2/3 giro	± 1/12 giro	
	M18 Tipos L, M, MA, MW	30-40 Nm	± 1/4 giro	± 1/12 giro	
Asiento cónico	M14 Tipos PT, PTJ, T	20-30 Nm	± 1/16 giro	± 1/16 giro	
	M18 Tipo MA	30-40 Nm	± 1/4 giro	± 1/12 giro	



Si se ha aplicado un lubricante a la rosca, tal como grasa, el apriete al par recomendado resulta excesivo y podría causar fuga en el cierre. No aplique lubricante de rosca.

Un apriete que exceda los ángulos y pares de apriete indicados a la derecha podría dañar el motor y provocar que la bujía se salga de la rosca.

E

Características de las bujías

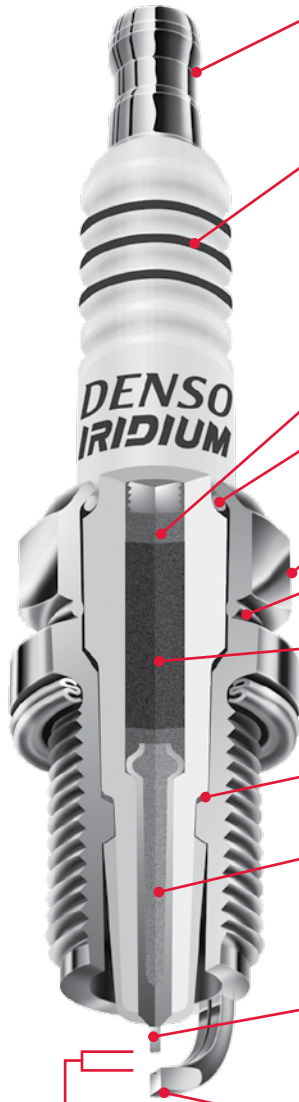

Terminal

- > Roscado, extraíble, engastado o sólido

Aislante de cerámica

- > Diseño de cinco nervaduras por toda la superficie
- > Esto reduce la pérdida de voltaje y impide fallo de chispas
- > Utilización de aluminio de gran pureza
- > Buen aislamiento eléctrico, gran durabilidad y buena conductividad térmica
- > Químicamente estable

Arandelas

Cierre especial de cobre-cristal

- > Buena hermeticidad, durabilidad y conductividad térmica.

Alojamiento

- > Recubrimiento de níquel muy anticorrosivo

Junta contra calor producido por electricidad

- > Termorresistente, buena hermeticidad y baja fluctuación de gama de calor

Resistencia

- > Con una resistencia de 5 K Ω , reduce el ruido radio eléctrico.

Empaquetadura

Electrodo central con núcleo de cobre

- > En comparación con otros fabricantes, DENSO utiliza concentraciones de cobre superiores para obtener mejores propiedades térmicas
- > Una chispa intensa y constante tanto a bajas como a altas velocidades.

Electrodo central

- > Las bujías de iridio DENSO cuentan con el electrodo central de menor diámetro del mundo: 0,4 mm
- > Disponible con punta de platino para una larga vida útil
- > Disponible con punta de aguja para una larga vida útil y una mejor capacidad de ignición

Electrodo de masa

- > Disponible con ranura en U para una mejor combustión
- > Diseño cónico para una ignición estable

Espacio de chispa

- > La separación entre electrodos de la mayoría de las bujías de DENSO viene precalibrada para que pueda utilizarlas directamente en su aplicación, por lo que no será necesario que ajuste dicha separación.

Spark Plugs | Tabla de identificación

E



Bujías Iridium / Platinum / Níquel

IDENTIFICACIÓN DE LAS BUJÍAS DE ENCENDIDO DENSO																																																																
	W	16	E	XR	-U	11																																																										
	K	20		PR	-A	11																																																										
	XU	22	H	CR	-11S																																																											
Tipo de metal precioso	Diámetro de rosca y tamaño de hexágono	Grado térmico			Longitud de rosca	Forma (tipo)	Forma (tipo)	Separación de electrodos																																																								
D Iridio de 0.7 mm de diámetro con punta de platino tipo aguja (SIP)	C 12x14.0 L 18x22.2 (Longitud: 12.7 mm) M 18x25.4 (Longitud: 12 mm) MA 18x20.6 (Asiento cónico, Longitud: 12 mm) MW 18x20.6 (Longitud: 12 mm) J 14x20.6 (Bujía proyectada) K 14x16.0 (Bujía miniatura) KJ 14x16.0 (Bujía miniatura proyectada) LP 14x20.6 (Bujía para aplicaciones GLP) Q 14x16.0 (Bujía miniatura) QJ 14x16.0 (Bujía miniatura proyectada) QL 14x20.6 (Bujía miniatura con alojamiento de cilindro largo) S 14x20.6 (Bujía de descarga superficial para motores RE) T 14x16.0 (Asiento cónico) W 14x20.6 14x19.0 (Tipo compacto) X 12x18.0 XE 12x14.0 XU 12x16.0 N 10x16.0 U 10x16.0 Y 8x13.0	<table border="1"> <thead> <tr> <th>DENSO</th> <th>NGK</th> <th>CHAMPION</th> <th>BOSCH</th> </tr> </thead> <tbody> <tr> <td>4</td> <td></td> <td></td> <td></td> </tr> <tr> <td>9</td> <td>2</td> <td>18</td> <td>10</td> </tr> <tr> <td>14</td> <td>4</td> <td>16,14</td> <td>9</td> </tr> <tr> <td>16</td> <td>5</td> <td>12,11</td> <td>8</td> </tr> <tr> <td>20</td> <td>6</td> <td>10,9</td> <td>7,6</td> </tr> <tr> <td>22</td> <td>7</td> <td>8,7</td> <td>5</td> </tr> <tr> <td>24</td> <td>8</td> <td>6,63,61</td> <td>4</td> </tr> <tr> <td>27</td> <td>9</td> <td>4,59</td> <td>3</td> </tr> <tr> <td>29</td> <td>9.5</td> <td>57</td> <td></td> </tr> <tr> <td>31</td> <td>10</td> <td>55</td> <td>2</td> </tr> <tr> <td>32</td> <td>10.5</td> <td>53</td> <td></td> </tr> <tr> <td>34</td> <td>11</td> <td></td> <td></td> </tr> <tr> <td>35</td> <td>11.5</td> <td></td> <td></td> </tr> </tbody> </table>			DENSO	NGK	CHAMPION	BOSCH	4				9	2	18	10	14	4	16,14	9	16	5	12,11	8	20	6	10,9	7,6	22	7	8,7	5	24	8	6,63,61	4	27	9	4,59	3	29	9.5	57		31	10	55	2	32	10.5	53		34	11			35	11.5			A 19.0 mm (Posición de la chispa: 7.0 mm) J16AR-U11 A 21.5 mm S29A B 19.0 mm (Posición de la chispa: 9.5 mm) J16BR-U C 19.0 mm (Posición de la chispa: 5.0 mm) KJ20CR-L11 D 19.0 mm (Carenado 2) K20DTR-S11 E (Con junta) 19.0 mm W16EX-U E (Con junta) 20.0 mm W25EBR E (Asiento cónico) 19.0 mm T16EPR-U F 12.7 mm W20FP-U FE 19.0 mm (Media rosca) U24FER9 G 19.0 mm (Carenado 3.5) PK20GR8 G 19.0 mm (Carenado 3) X27GPR-U H 26.5 mm QJ16HR-U H 19.0 mm (Posición de la chispa: 8.5 mm) K16HPR-U11 L 11.2 mm W14L N (Asiento cónico, Media rosca) 17.5 mm T20NR-U11 V (Asiento cónico) 25.0 mm PT16VR13 Ninguno 9.5 mm W14M-U 11.2 mm L14-U, M24S 19.0 mm SK20R11 21.5 mm S29A Ninguno (Asiento cónico) 8.3 mm T20M-U 11.2 mm T16PR-U	A Electrodo de masa dobles W22EA AY Electrodo de masa dobles curvados J16AY B Electrodo de masa triples W22EB BG Electrodo de masa triples (carenado) SK20BGR11 C Carenado 1.5 mm SXU22HCR11 D 4 electrodos de masa W27EDR D Proyectado (proyección de 1.5 mm, posición de la chispa 3.5 mm) XU22HDR9 E Carenado 2.0 mm FXE20HE11 K Proyectado (proyección de 1 mm) W16EKR-S11 LM Tipo compacto (hexágono 20.6 mm) W14LM-U M Cabezal aislante de longitud corta W27EMR-C M Tipo compacto (hexágono 19.0 mm) W20M-U P Proyectado (proyección de 1.5 mm) W16EP-U Q Proyectado 2 mm, posición de la chispa 3.5 mm R Resistencia de 5 kΩ K16R-U S No proyectado (proyección de 0 mm) W22ES-U S Iridio en un solo lado KJ20SR11 T Electrodo de masa dobles K16TR11 TM Electrodo de masa dobles K22TMR11 TN Electrodo de masa dobles K22TNR-S X Totalmente proyectado (proyección de 2.5 mm) W16EX-U	-A Especificación especial SK16PR-A11 -B Especificación especial K16PSR-B8 -C Electrodo de masa truncados W27EMR-C -D Electrodo de masa con núcleo de cobre DK20PR-D13 -E Especificación especial SK16PR-E11 -F Especificación especial SK16PR-F11 -G Rosca lubricada para aplicaciones GNC SK20R8-G -GL Electrodo central de platino X22EPR-GL -L Electrodo de masa resistente al calor K20PR-L11 -L Aislante proyectado de 3.5 mm para motocicletas W20FP-UL -L Aislante retraído para motocicletas W20FR-L -M Electrodo de masa de mayor tamaño SK20PR-M11S -N Para Yamaha y Kawasaki U27ESR-N -P Electrodo de masa con doble capa de platino SK20R-P11 -P Bujía de platino en un solo lado K16PR-P11 -R Resistencia de 10 kΩ K22PR-UR -S Tipo de descarga semisuperficial W20EP-S11 -S Junta de acero inoxidable U27FER9S -T Para GLP SK20HR8-T -T Especificación especial FK20HBR11-T -TP Bujía de platino en un solo lado con corte cónico K20PR-TP11 -U Electrodo de masa U-groove K16PR-U -US Electrodo central en forma de estrella W20M-US -V Electrodo central de níquel de 1.3 mm de diámetro W27ES-V	5 0.5 mm (.020") 8 0.8 mm (.032") 9 0.9 mm (.035") 10 1.0 mm (.040") 11 1.1 mm (.044") 13 1.3 mm (.050") 14 1.4 mm (.055") 15 1.5 mm (.060") <ninguno> Automóviles: 0.8 mm Motocicletas: 0.7 mm <Excepciones>: P16R, PQ16R, PQ20R son de 1.1 mm
DENSO	NGK	CHAMPION	BOSCH																																																													
4																																																																
9	2	18	10																																																													
14	4	16,14	9																																																													
16	5	12,11	8																																																													
20	6	10,9	7,6																																																													
22	7	8,7	5																																																													
24	8	6,63,61	4																																																													
27	9	4,59	3																																																													
29	9.5	57																																																														
31	10	55	2																																																													
32	10.5	53																																																														
34	11																																																															
35	11.5																																																															

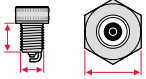

Spark Plugs | Tabla de identificación

E

IRIDIUM POWER® Serie Iridium Power (Power, Tough)

IDENTIFICACIÓN DE LAS BUJÍAS DE ENCENDIDO DENSO																																															
I	U	27	A																																												
VF	KH	20																																													
																																															
Bujía de encendido de altas prestaciones	Diámetro y longitud de rosca, tamaño de hexágono	Grado térmico	Forma (tipo)																																												
I Iridio de 0.4 mm de diámetro V Iridio de 0.4 mm de diámetro con punta de platino VF Iridio de 0,4 mm de diámetro con punta de platino tipo aguja (SIP)	<Diámetro de rosca x longitud x tamaño de hexágono> CH ... 12x26.5x14.0 K 14x19.0x16.0 KA ... 14x19.0 (Nuevo electrodo triple carenado)x16.0 KB ... 14x19.0 (Nuevos electrodos triples)x16.0 KBH ... 14x26.5 (Nuevos electrodos triples)x16.0 KD ... 14x19.0 (Carenado)x16.0 KH ... 14x26.5x16.0 NH ... 10x19.0 (Media rosca)x16.0 T 14x17.5 (Asiento cónico)x16.0 TF ... 14x11.2 (Asiento cónico)x16.0 TL ... 14x25.0 (Asiento cónico, aislante largo)x16.0 TV ... 14x25.0 (Asiento cónico)x16.0 Q 14x19.0x16.0 U 10x19.0x16.0 UF ... 10x12.7x16.0 UH ... 10x19.0 (Media rosca)x16.0 W 14x19.0x20.6 WF ... 14x12.7x20.6 WM ... 14x19.0x20.6 (Aislante compacto) X 12x19.0x18.0 XEH ... 12x26.5 (Carenado 2.0)x14.0 XG ... 12x19.0 (Carenado 3.0)x18.0 XU ... 12x19.0x16.0 XUH ... 12x26.5x16.0 Y 8x19.0 (Media rosca)x13.0	<table border="1"> <thead> <tr> <th>DENSO</th> <th>NGK</th> <th>CHAMPION</th> <th>BOSCH</th> </tr> </thead> <tbody> <tr> <td>16</td> <td>5</td> <td>12,11</td> <td>8</td> </tr> <tr> <td>20</td> <td>6</td> <td>10,9</td> <td>7,6</td> </tr> <tr> <td>22</td> <td>7</td> <td>8,7</td> <td>5</td> </tr> <tr> <td>24</td> <td>8</td> <td>6,63,61</td> <td>4</td> </tr> <tr> <td>27</td> <td>9</td> <td>4,59</td> <td>3</td> </tr> <tr> <td>29</td> <td>9.5</td> <td>57</td> <td></td> </tr> <tr> <td>31</td> <td>10</td> <td>55</td> <td>2</td> </tr> <tr> <td>32</td> <td>10.5</td> <td>53</td> <td></td> </tr> <tr> <td>34</td> <td>11</td> <td></td> <td></td> </tr> <tr> <td>35</td> <td>11.5</td> <td></td> <td></td> </tr> </tbody> </table>	DENSO	NGK	CHAMPION	BOSCH	16	5	12,11	8	20	6	10,9	7,6	22	7	8,7	5	24	8	6,63,61	4	27	9	4,59	3	29	9.5	57		31	10	55	2	32	10.5	53		34	11			35	11.5			A Electrodo inclinado, sin U-groove, sin perfil cónico B Aislante proyectado (1.5 mm) C Sin U-groove D Electrodo de masa Inconel, sin U-groove E Carenado: 2 mm ES .. Junta de acero inoxidable F Especificación especial G Junta de acero inoxidable I Posición de la chispa: 4 mm Aislante proyectado (1.5 mm) J Posición de la chispa: 5 mm K Posición de la chispa: 4 mm Aislante proyectado (2.5 mm) L Posición de la chispa: 5 mm T Para aplicaciones GLP Y Separación de electrodos 0.8 mm Z Corte cónico
DENSO	NGK	CHAMPION	BOSCH																																												
16	5	12,11	8																																												
20	6	10,9	7,6																																												
22	7	8,7	5																																												
24	8	6,63,61	4																																												
27	9	4,59	3																																												
29	9.5	57																																													
31	10	55	2																																												
32	10.5	53																																													
34	11																																														
35	11.5																																														

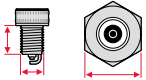
TT

IDENTIFICACIÓN DE LAS BUJÍAS DE ENCENDIDO DENSO																			
I	W	16	TT																
	XEH	20	ETT																
																			
Type of precious metal	Diámetro y longitud de rosca, tamaño de hexágono	Grado térmico	Forma (tipo)																
I Iridio, Ø 0,4 mm, con punta de platino de tipo aguja	<Diámetro de rosca x longitud x tamaño de hexágono> mm K 14x19.0x16.0 KBH ... 14x26.5 (nuevos electrodos triples)x16.0 KH ... 14x26.5x16.0 Q 14x19.0x16.0 T 14x17.5 (asiento cónico)x16.0 TF ... 14x11.2 (asiento cónico)x16.0 TL ... 14x25.0 (asiento cónico, aislador largo)x16.0 TV ... 14x25.0 (asiento cónico)x16.0 W 14x19.0x20.6 WF ... 14x12.7x20.6 XEH ... 12x26.5 (cubierta 2.0)x14.0 XU ... 12x19.0x16.0 XUH ... 12x26.5x16.0	<table border="1"> <thead> <tr> <th>DENSO</th> <th>NGK</th> <th>CHAMPION</th> <th>BOSCH</th> </tr> </thead> <tbody> <tr> <td>16</td> <td>5</td> <td>12,11</td> <td>8</td> </tr> <tr> <td>20</td> <td>6</td> <td>10,9</td> <td>7,6</td> </tr> <tr> <td>22</td> <td>7</td> <td>8,7</td> <td>5</td> </tr> </tbody> </table>	DENSO	NGK	CHAMPION	BOSCH	16	5	12,11	8	20	6	10,9	7,6	22	7	8,7	5	E Cubierta: 2 mm IXEH20ETT TT ... Nickel TT (electrodo central: Ø 1,5 mm; electrodo de masa: Ø 1,5 mm) W16TT TT ... Iridium TT (electrodo central: Ø 0,4 mm; electrodo de masa: Ø 0,7 mm) IW16TT I Posición de la chispa: 4 mm Aislador proyectado (1,5 mm) XUH20TTI
DENSO	NGK	CHAMPION	BOSCH																
16	5	12,11	8																
20	6	10,9	7,6																
22	7	8,7	5																

Gama de bujías de calentadores

El programa de bujías de calentadores de DENSO es un importante lanzamiento de productos para equipos originales de todas las marcas, y tiene como objetivo proporcionar a los clientes de recambios una avanzada selección alternativa de marcas con las que hacer frente a las crecientes necesidades de sus vehículos diesel.

Este programa de última generación se beneficia del renombre de DENSO Corporation como uno de los mayores productores en todo el mundo de bujías de calentadores para Equipos Originales para destacados fabricantes de vehículos a nivel global. Desarrollado conforme a las normas de equipo original (OE), nuestro programa de Bujías Incandescentes para el Mercado del Recambio comprende 138 componentes, abarcando más de 4,800 aplicaciones. Esto equivale al 98% del parque automovilístico europeo. Se prevé la realización de extensiones continuas con el fin de ir mejorando nuestra gama de productos en todo momento.

El programa de bujías de calentadores DENSO abarca todas las tecnologías actuales en materia de bujías de calentadores, incluyendo bujías de una espiral, bujías de dos espirales, bujías con post-calentamiento de larga duración, bujías cerámicas y calentamiento instantáneo.

Características de las bujías de calentadores DENSO:

- > Bujías incandescentes de calidad para equipos originales que satisfacen o superan las especificaciones de los fabricantes.
- > Tiempos de precalentamiento más rápidos y la confiabilidad de un arranque en frío.
- > Temperaturas de poscalentamiento de larga duración que reducen las emisiones de gases.
- > Una excelente cobertura garantiza la idoneidad para la mayoría de los motores en Europa.
- > Más aplicaciones disponibles con menos referencia de piezas.
- > Sistema de numeración de piezas fácil de usar.
- > Cumple con las normas ISO TS16949, ISO14001 y OHSAS 18001.

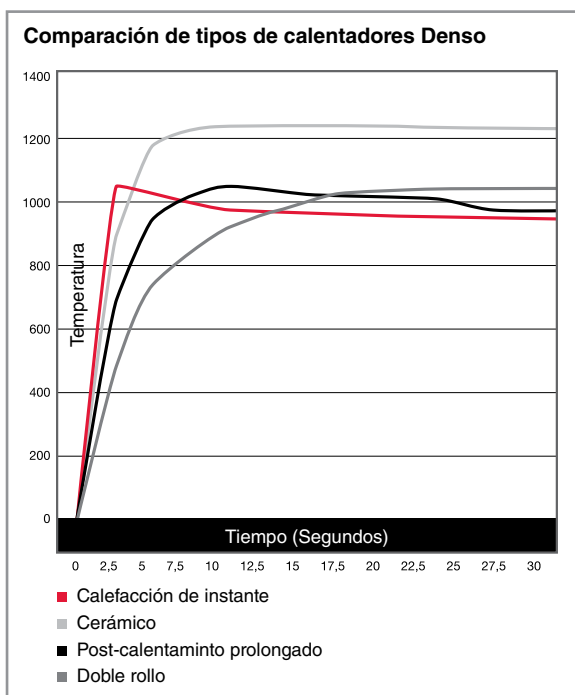

¿Cómo montar una bujía de incandescencia?

Especificación de par de apriete recomendado para bujías incandescentes DENSO:

1. Utilice la llave correcta para la bujía incandescente y el terminal.
2. Al cambiar las bujías incandescentes, asegúrese de que el aceite, la suciedad, etc. adheridos al exterior de la bujía incandescente desmontada no entren en el cilindro.
3. Al instalar la bujía incandescente, limpie el lateral del motor de la brida y asegúrese de que la bujía incandescente esté alineada correctamente con la rosca de la culata.
4. Asegúrese de que la bujía incandescente esté colocada correctamente y apriétela a mano hasta que no pueda apretarse más.
5. A continuación, use la llave dinamométrica para apretarla exactamente al par de apriete que se muestra en el cuadro siguiente.

PAR DE MONTAJE RECOMENDADO		
Tamaño de la rosca	Par recomendado	
Bujías de calentadores	M8x1.00	8-10 Nm
	M9x1.00	8-10 Nm
	M10x1.00	10-12 Nm
	M10x1.25	10-12 Nm
	M12x1.25	15-20 Nm
	M14x1.25	20-25 Nm
Terminal	M18x1.50	30-40 Nm
	M4x0.7	1-1.5 Nm
	M5x0.8	3-4 Nm

! NO UTILICE LUBRICANTE PARA ROSCAS! Si se utiliza un lubricante para roscas -como por ejemplo grasa- para recubrir la rosca, se reducirá la resistencia entre la bujía incandescente y la culata, lo que provocará un apriete excesivo.

! Si se aprieta por encima del par de apriete que se muestra en la tabla anterior, se pueden producir daños en la bujía incandescente y en el motor.

! El fallo de la bujía de incandescencia está causado normalmente por una tensión o un calor excesivos. Las bujías de incandescencia están diseñadas para trabajar a temperaturas entre 850° C y 1 100° C. Cuando la corriente eléctrica en la bujía de incandescencia se mantiene durante un tiempo excesivo, sea por un fallo del relé o del controlador, puede producirse un sobrecalentamiento que a su vez hará que la bujía se expanda, fracture o explote, produciéndose su fallo inmediato. Es por tanto aconsejable comprobar todo el sistema eléctrico antes de cambiar las bujías de incandescencia por un nuevo juego. Una regulación del encendido demasiado adelantada, unos inyectores con fugas o la inyección de gasoil en el motor producirán un incremento excesivo de la temperatura, causando daños a las bujías de incandescencia. **Un relé y controlador defectuosos también pueden causar el fallo de las bujías incandescentes** así que conviene revisar todo el sistema antes de cambiar las bujías.

E

Una tecnología superior para las bujías de incandescencia

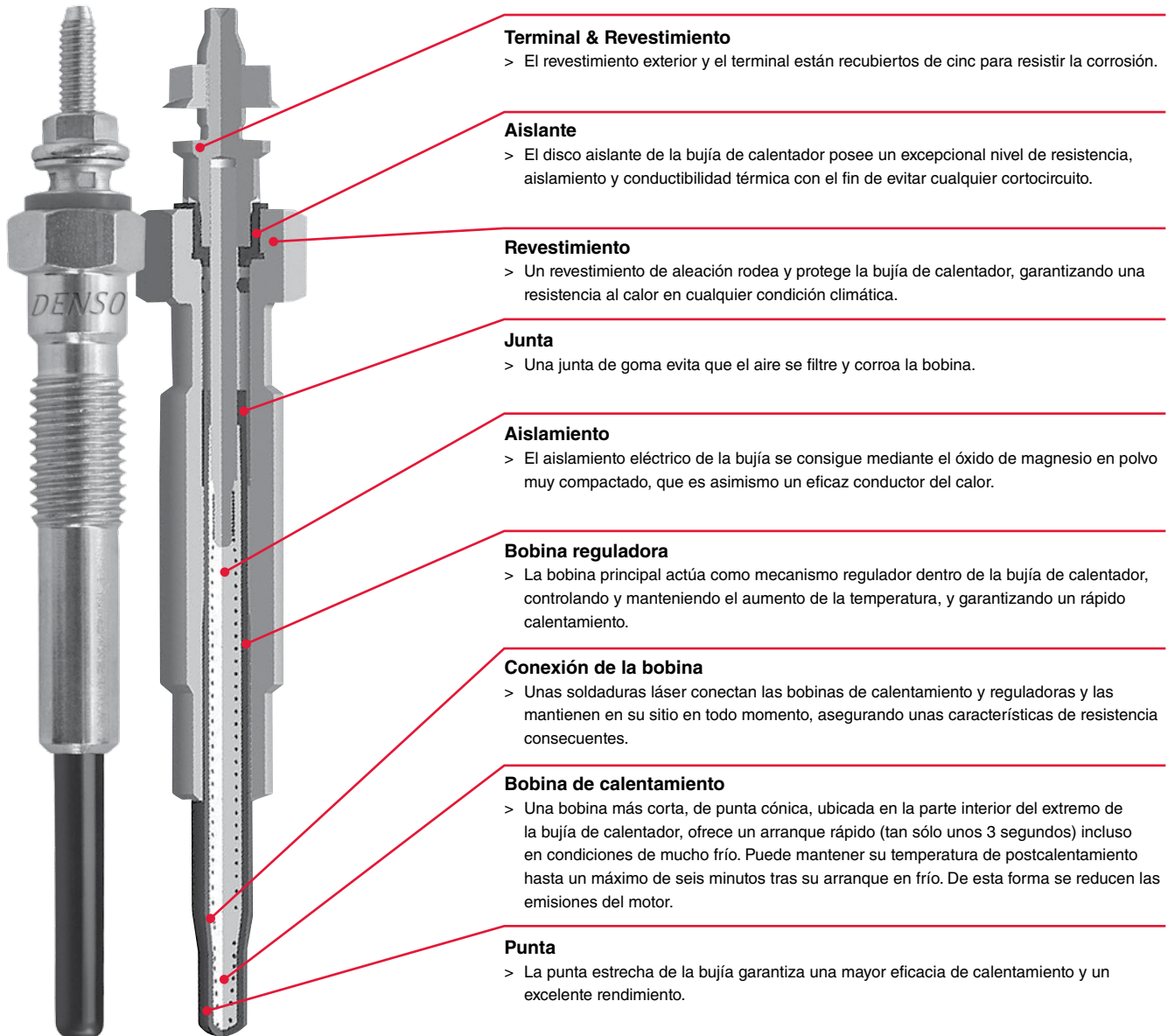

DENSO: la differenza

Nel settore delle tecnologia applicata alle candele, DENSO è il punto di riferimento ormai dal lontano 1959. DENSO sviluppa internamente le proprie gamme, mentre la produzione è affidata ai propri stabilimenti mondiali, certificati cati QS 9000 e ISO 9000, con 'zero difetti' come standard. La nostra azienda offre questa eccezionale qualità OE anche all'Aftermarket. Le candele al nickel, al platino, Twin Tip e all'iridio di DENSO coprono una vasta gamma di applicazioni, con aggiornamenti continui, e garantiscono sempre ottime prestazioni. Scegliete le candele DENSO per tutte le vostre esigenze applicative: auto, moto, imbarcazioni o piccoli motori.

Gamma

Twin Tip (TT)

Nickel TT

- > Anima in lega di nichel e doppio elettrodo di massa prominente
- > Emissioni ridotte di CO₂
- > Minor consumo di carburante
- > Migliore rendimento del motore anche in condizioni estreme
- > Miglior rapporto qualità / prezzo tra le candele ad alte prestazioni

Iridium TT

- > Accensione migliorata e più affidabile
- > Prestazioni migliorate fino al 20% rispetto alle tradizionali candele in nichel
- > Durata di 120.000 km
- > Tecnologia OEM di fascia alta ora disponibile a un prezzo inferiore per una gamma di veicoli più ampia
- > Risparmio di carburante

Le informazioni presenti nel catalogo sono da considerarsi valide in data di pubblicazione. Per le informazioni più aggiornate, fare riferimento al nostro catalogo elettronico.

Le raccomandazioni contenute nel presente catalogo si basano sulle ultime informazioni del produttore in merito al funzionamento in condizioni standard. Non saranno accettati reclami legali al contenuto del presente elenco.

Le informazioni dei riferimenti incrociati devono essere utilizzate solo a titolo di guida. Le differenze nella struttura e nel materiale tra i produttori possono variare all'interno della gamma di temperatura. Per le applicazioni specifiche del motore, fare riferimento alla sezione delle raccomandazioni.

Dove indicati, i nomi e/o i numeri dei produttori sono forniti solo come riferimento e non per indicare la fonte del produttore o un collegamento nella catena commerciale con il produttore indicato. Al fine di individuare la candela corretta, fare riferimento al numero della parte originale (OEM) sulla parte stessa, e trovare il numero parte DENSO corrispondente nella tabella di riferimento incrociato.

Montaggio diretto

Nickel

- > Sigillante interno in rame e vetro per una migliore dissipazione termica
- > U-groove standard
- > Anima in rame alloggiata in profondità
- > Placcatura in nichel resistente al calore
- > Disponibili candele con elettrodi di massa multipli

Double Platinum (Longlife)

- > Accensione migliorata e più affidabile
- > Combustione più completa (meno emissioni)
- > Maggiore capacità di rettificare eventuali imperfezioni nella messa a punto
- > Risposta dell'acceleratore e accelerazione superiori
- > Tecnologia testata nelle competizioni automobilistiche

Iridium Power

- > Eccezionali capacità d'accensione
- > Ridotto fabbisogno di tensione
- > Migliore risposta in accelerazione e stabilità
- > Consumo minore di carburante

Iridium Longlife, Iridium Tough

- > Eccezionali capacità d'accensione
- > Ridotto fabbisogno di tensione
- > Migliore risposta in accelerazione e stabilità
- > Consumo minore di carburante
- > Vita in servizio più lunga

Candele SIP (Super-Ignition Plug)

- > Elettrodi centrale e di massa ultra-sottili a lunga durata
- > Alta tecnologia applicata alle candele
- > Componenti di primo impianto sulle autovetture Honda, Hyundai, Kia, Lexus, Nissan, Mitsubishi, Mazda, Subaru, Toyota e Volvo
- > Prestazioni superiori
- > Massima durabilità

Racing

Iridium Racing

- > Tecnologia F1
- > Accelerazione ineguagliabile
- > Elevata affidabilità
- > Prestazioni potenziate



DENSO: la differenza

Range	TT Range		Direct Fit							Racing
Material	Nickel	Iridium	Nickel	Platinum	Iridium					Iridium
Type	Nickel TwinTip	Iridium TwinTip	Nickel	Platinum	Iridium OEM ⁵	Iridium Long life ⁵	Iridium Power	Iridium Tough	SIP	Iridium Racing
U-groove	-	-	+ ¹	-	-	-	+ ²	-	-	-
Elettrodo di massa rastremato	-	Alcuni tipi	Alcuni tipi ³	-	-	-	+ ²	-	Alcuni tipi	-
Materiale elettrodo di massa	Lega di nichel	Punta al platino ⁶	Normale	Punta al platino	Punta al platino	Punta al platino	Normale	Punta al platino ⁷	Punta al platino ⁶	Completamente al platino
Elettrodo centrale	1.5 mm	0.55 mm	2.5 mm	1.1 mm	0.7 mm	0.4 mm	0.4 mm	0.4 mm	0.55 mm	0.4 mm ⁴
Gradazione termica disponibile	16-20	20-24	9-27	16-22	16-22	16-27	16-34	16-24	20-24	24-35
Resistore	Tutti i tipi	Tutti i tipi	La maggior parte	Tutti i tipi	Tutti i tipi	Tutti i tipi	Tutti i tipi	Tutti i tipi	Tutti i tipi	Tutti i tipi
Prestazioni elevate	+++	+++++	+	++	++++	++++	++++	++++	+++++	+++++
Risparmio carburante	Molto buono	Ottimo	Buono	Molto buono	Ottimo	Ottimo	Ottimo	Ottimo	Ottimo	-
Vita in servizio	Standard	Lunga	Standard	Lunga	Lunga	Lunga	Standard	Lunga	Lunga	Solo per competizione

¹ I tipi di candela senza 'U' nel nome non sono dotati di U-groove

² Non applicabile a IU24A, IU27A, IU31A, IUF27A e IUF31A

³ I tipi di candela con una 'Z' nel nome sono dotati di elettrodo di massa rastremato

⁴ Tranne i tipi a scarica superficiale

⁵ Tipi OEM, solo per determinati veicoli

⁶ elettrodi di massa in platino da 0,7 mm

⁷ Disponibile con 7 elettrodi di massa in platino da 0,7 mm

I

Installazione Delle Candele

Coppia ed angolo di serraggio consigliati per candele DENSO

1. Utilizzare la chiave corretta per la profilatura esagonale della candela e far attenzione a non danneggiare l'isolatore.
2. Cambiando le candele, assicurarsi che l'olio, etc., all'esterno delle candele non penetri all'interno del motore.
3. Durante l'inserimento delle candele, pulire il lato della flangia verso il motore, ed inserire la candela dopo essersi assicurati che la guarnizione sia presente sulla flangia.
4. Assicurarsi che le candele siano in posizione verticale, e serrarle a mano fino a ottenere resistenza (A+B).
5. Quindi, usare la chiave dinamometrica per serrare fino a raggiungere esattamente il valore della coppia mostrato nel diagramma seguente. Se non è disponibile una chiave dinamometrica, usare una chiave per candele per serrare effettuando i giri consigliati. Per ulteriori informazioni sul valore di coppia assoluto, consultare il nostro catalogo elettronico (C+D).

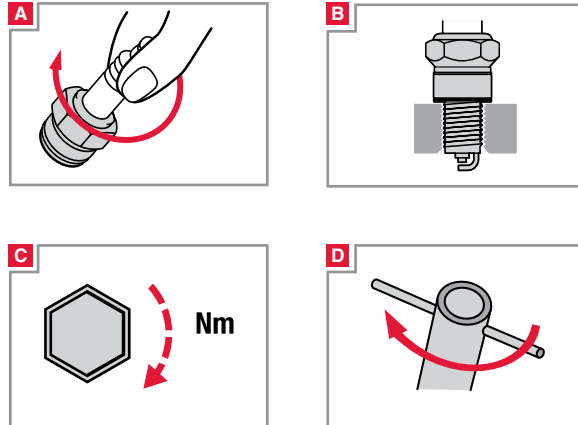

<http://www.denso-am.eu/e-catalogue/>

SPECIFICHE DI COPPIA CONSIGLIATE PER L'INSTALLAZIONE					
Filettatura	Coppia consigliata	Rotazioni consigliata			
		Candela nuova	Candela usata		
M8 Tipo Y	8-10 Nm	± 1 giro	± 1/12 giro		
M10 Tipo U, N	10-15 Nm	± 2/3 giro	± 1/12 giro		
M10 Guarnizione d'acciaio inossidabile	10-15 Nm	± 3/4 giro	± 1/12 giro		
M12 Tipo SXU, X, XE, XU, ZXE, ZXU	15-20 Nm	± 1/3 giro	± 1/12 giro		
M14 Tipo FK, J, K, KJ, P, PK, PKJ, PQ, Q, QJ, QL, S, SF, SK, SKJ, SV, SVK, VK, VKJ, W, ZT	20-25 Nm	± 1/2 giro	± 1/12 giro		
M14 Guarnizione d'acciaio inossidabile	20-25 N	± 2/3 giro	± 1/12 giro		
M18 Tipo L, M, MA, MW	30-40 Nm	± 1/4 giro	± 1/12 giro		
Sede conica	M14 Tipo PT, PTJ, T	± 1/16 giro	± 1/16 giro		
	M18 Tipo MA	± 1/4 giro	± 1/12 giro		



Nel caso che un lubrificante per filetti sia cosparsa sul filetto, il serraggio alla coppia consigliata è troppo elevato; questo fatto è stato collegato alla perdita dalla guarnizione. Non impiegare un lubrificante per filetti.

Un serraggio che superi gli angoli di serraggio e le coppie indicate a destra potrebbe provocare danni al motore, ed inoltre una rottura della candela al livello del filetto.



Caratteristiche delle candele

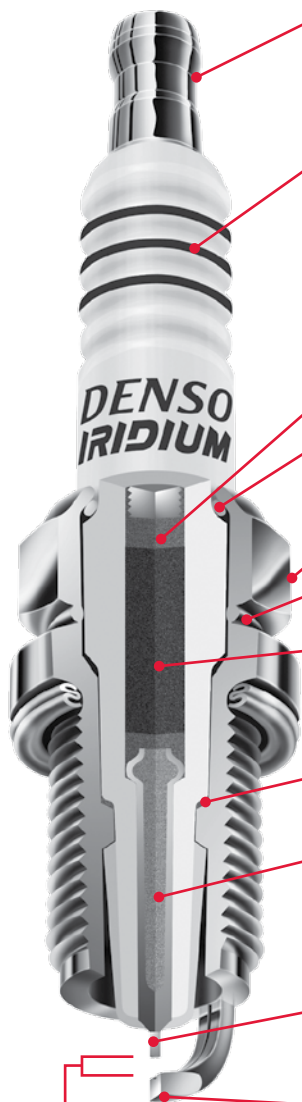

Terminale

- > Filettato, amovibile, crimpato o rigido

Isolatore di ceramica

- > Il disegno a cinque nervature è utilizzato su tutta la superficie
- > Esso riduce le perdite di tensione e previene mancate scintille
- > Viene impiegata allumina ad elevata purezza
- > Buona isolamento elettrica, durata e conducibilità termica
- > Chimicamente stabile

Anello

Matrice sigillante speciale in rame-vetro

- > L'impermeabilità all'aria, la durata e la conducibilità termica sono buone

Alloggiamento

- > Una nichelatura altamente resistente alla corrosione

Guarnizione di calore elettrico

- > Ad alta resistenza, offre una buona ermeticità e una bassa variazione del range di calore

Resistore

- > Con una resistenza da 5 K Ω , riduce i radio-disturbi

Cappuccio della candela

Elettrodo centrale ad anima di rame

- > Rispetto ad altri produttori DENSO utilizza concentrazioni di rame più elevate per migliori proprietà termiche
- > Dalle basse alle alte velocità, una candela robusta e rigida

Elettrodo centrale

- > Le candele all'iridio DENSO presentano l'elettrodo centrale dal diametro (0,4 mm) più ridotto al mondo

Elettrodo di messa a terra

- > Disponibile con scanalatura ad "U", che offre una combustione più completa
- > L'intaglio conico produce un'accensione costante.
- > Disponibile con elettrodo in platino per una maggiore durata
- > Disponibile con elettrodo ad ago per massima durabilità e miglior accensione







Distanza della scintilla

- > La maggior parte delle candele DENSO ha il gap calibrato per adattarsi alla vostra applicazione, pertanto non occorre effettuare questa operazione

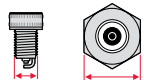
Spark Plugs | Tabella di identificazione

I

Candele Iridium / Platinum / Nickel

IDENTIFICAZIONE DELLE CANDELE DENSO																																																										
	W	16	E	XR	-U	11																																																				
S	K	20		PR	-A	11																																																				
S	XU	22	H	CR	-11S																																																					
																																																										
Tipo di metallo prezioso	Diametro filettatura e misura dell'esagono di serraggio	Grado termico	Lunghezza parte filettata	Forma (tipo)	Forma (tipo)	Gap																																																				
<p>D ... Iridio diametro 0.7 mm con elettrodo ad ago in platino (SIP)</p> <p>F ... Iridio diametro 0.55 mm con elettrodo ad ago in platino (SIP)</p> <p>P ... Platino diametro 1.1 mm con elettrodo in platino</p> <p>S ... Iridio diametro 0.7 mm con elettrodo in platino</p> <p>SV ... Iridio diametro 0.4 mm con elettrodo in platino</p> <p>Z ... Iridio diametro 0.55 mm con elettrodo in platino</p>	<p>C 12x14.0</p> <p>L 18x22.2 (Lunghezza parte filettata: 12.7 mm)</p> <p>M 18x25.4 (Lunghezza parte filettata: 12 mm)</p> <p>MA 18x20.6 (Misura sede conica: 12 mm)</p> <p>MW 18x20.6 (Lunghezza parte filettata: 12 mm)</p> <p>J 14x20.6 (Candela proiettata)</p> <p>K 14x16.0 (Candela mini)</p> <p>KJ 14x16.0 (Candela mini proiettata)</p> <p>LP 14x20.6 (Candela per applicazioni GPL)</p> <p>Q 14x16.0 (Candela mini)</p> <p>QJ 14x16.0 (Candela mini proiettata)</p> <p>QL 14x20.6 (Candela mini con sezione cilindrica centrale allungata)</p> <p>S 14x20.6 (Candela a gap superficiale (per motori RE))</p> <p>T 14x16.0 (Sede conica)</p> <p>W 14x20.6 14x19.0 (Tipo compatto)</p> <p>X 12x18.0</p> <p>XE 12x14.0</p> <p>XU 12x16.0</p> <p>N 10x16.0</p> <p>U 10x16.0</p> <p>Y 8x13.0</p>	<table border="1"> <thead> <tr> <th>DENSO</th> <th>NGK</th> <th>CHAMPION</th> <th>BOSCH</th> </tr> </thead> <tbody> <tr> <td>4</td> <td>2</td> <td>18</td> <td>10</td> </tr> <tr> <td>9</td> <td>4</td> <td>16,14</td> <td>9</td> </tr> <tr> <td>14</td> <td>5</td> <td>12,11</td> <td>8</td> </tr> <tr> <td>16</td> <td>6</td> <td>10,9</td> <td>7,6</td> </tr> <tr> <td>20</td> <td>7</td> <td>8,7</td> <td>5</td> </tr> <tr> <td>24</td> <td>8</td> <td>6,63,61</td> <td>4</td> </tr> <tr> <td>27</td> <td>9</td> <td>4,59</td> <td>3</td> </tr> <tr> <td>29</td> <td>9.5</td> <td>57</td> <td></td> </tr> <tr> <td>31</td> <td>10</td> <td>55</td> <td>2</td> </tr> <tr> <td>32</td> <td>10.5</td> <td>53</td> <td></td> </tr> <tr> <td>34</td> <td>11</td> <td></td> <td></td> </tr> <tr> <td>35</td> <td>11.5</td> <td></td> <td></td> </tr> </tbody> </table>	DENSO	NGK	CHAMPION	BOSCH	4	2	18	10	9	4	16,14	9	14	5	12,11	8	16	6	10,9	7,6	20	7	8,7	5	24	8	6,63,61	4	27	9	4,59	3	29	9.5	57		31	10	55	2	32	10.5	53		34	11			35	11.5			<p>A 19.0 mm (Posizione scintilla: 7.0 mm) J16AR-U11</p> <p>A 21.5 mm S29A</p> <p>B 19.0 mm (Posizione scintilla: 9.5 mm) J16BR-U</p> <p>C 19.0 mm (Posizione scintilla: 5.0 mm) KJ20CR-L11</p> <p>D 19.0 mm (Protezione 2) K20DTR-S11</p> <p>E (Con guarnizione) ... 19.0 mm W16EX-U</p> <p>E (Con guarnizione) ... 20.0 mm W25EBR</p> <p>E (Sede conica) ... 19.0 mm T16EPR-U</p> <p>F 12.7 mm W20FP-U</p> <p>FE 19.0 mm (Mezza filettatura) U24FER9</p> <p>G 19.0 mm (Protezione 3.5) PK20GR8</p> <p>G 19.0 mm (Protezione 3) X27GPR-U</p> <p>H ... 26.5 mm QJ16HR-U</p> <p>H 19.0 mm (Posizione scintilla: 8.5 mm) K16HPR-U11</p> <p>L 11.2 mm W14L</p> <p>N (Sede conica, mezza filettatura) 17.5 mm T20NR-U11</p> <p>V (Sede conica) ... 25.0 mm PT16VR13</p> <p>Nessuna 9.5 mm W14M-U 11.2 mm L14-U, M24S 19.0 mm SK20R11 21.5 mm S29A</p> <p>Nessuna (Sede conica) 8.3 mm T20M-U 11.2 mm T16PR-U</p>	<p>A ... Doppio elettrodo di massa W22EA</p> <p>AY ... Doppio elettrodo di massa di forma ripiegata J16AY</p> <p>B ... Triplo elettrodo di massa W22EB</p> <p>BG ... Triplo elettrodo di massa (protezione) SK20BGR11</p> <p>C ... Protezione 1.5 mm SXU22HCR11</p> <p>D ... 4 Doppio elettrodo di massa W27EDR</p> <p>D ... Proiettata (proiezione 1.5 mm, posizione scintilla 3.5 mm) XU22HDR9</p> <p>E ... Copertura di protezione 2.0 mm FXE20HE11</p> <p>K ... Proiettata (proiezione 1 mm) W16EKR-S11</p> <p>LM ... Tipo compatto (esagono 20.6 mm) W14LM-U</p> <p>M ... Lunghezza testa isolatore accorciata W27EMR-C</p> <p>M ... Tipo compatto (esagono 19.0 mm) W20M-U</p> <p>P ... Proiettata 2 mm, posizione scintilla 3.5 mm W16EP-U</p> <p>Q ... Proiettata 2mm, Spark position 3.5mm</p> <p>R ... Resistore 5 kOhm K16R-U</p> <p>S ... Non-proiettata (proiezione 0 mm) W22ES-U</p> <p>S ... Iridio su un solo lato KJ20SR11</p> <p>T ... Doppio elettrodo di massa K16TR11</p> <p>TM ... Doppio elettrodo di massa K22TMR11</p> <p>TN ... Doppio elettrodo di massa K22TNR-S</p> <p>X ... Completamente proiettata (proiezione 2.5 mm) W16EX-U</p>	<p>-A ... Specifica speciale SK16PR-A11</p> <p>-B ... Specifica speciale K16PSR-B8</p> <p>-C ... Elettrodi di massa retrotagliati W27EMR-C</p> <p>-D ... Elettrodi di massa con nucleo in rame DK20PR-D13</p> <p>-E ... Specifica speciale SK16PR-E11</p> <p>-F ... Specifica speciale SK16PR-F11</p> <p>-G ... Grasso applicato alla filettatura per motori a metano SK20R8-G</p> <p>-GL ... Elettrodo centrale in platino X22EPR-GL</p> <p>-L ... Elettrodo di massa resistente al calore K20PR-L11</p> <p>-L ... Isolatore proiettato 3.5 mm per motocicli W20FP-UL</p> <p>-L ... Isolatore retratto per motocicli W20FR-L</p> <p>-M ... Elettrodo di massa più grande SK20PR-M11S</p> <p>-N ... Per Yamaha e Kawasaki U27ESR-N</p> <p>-P ... Doppio elettrodo di massa in platino SK20R-P11</p> <p>-P ... Candela al platino a lato singolo K16PR-P11</p> <p>-R ... Resistore 10K ohm K22PR-UR</p> <p>-S ... Tipo a scarica con gap semi-superficiale W20EP-S11</p> <p>-S ... Guarnizione inox U27FER9S</p> <p>-T ... Per GPL SK20HR8-T</p> <p>-T ... Specifica speciale FK20HBR11-T</p> <p>-TP ... Candela in platino a lato singolo e taglio conico K20PR-TP11</p> <p>-U ... Elettrodo di massa con scanalatura a U</p> <p>-US ... Elettrodo centrale a stella W20M-US</p> <p>-V ... Elettrodo centrale in nickel da 1.3 mm W27ES-V</p>	<p>5 0.5 mm (.020")</p> <p>8 0.8 mm (.032")</p> <p>9 0.9 mm (.035")</p> <p>10 1.0 mm (.040")</p> <p>11 1.1 mm (.044")</p> <p>13 1.3 mm (.050")</p> <p>14 1.4 mm (.055")</p> <p>15 1.5 mm (.060")</p> <p><Nessuno></p> <p>Autovetture 0.8 mm M/C: 0.7 mm</p> <p><Eccezioni>: P16R, PQ16R, PQ20R sono 1.1 mm</p>
DENSO	NGK	CHAMPION	BOSCH																																																							
4	2	18	10																																																							
9	4	16,14	9																																																							
14	5	12,11	8																																																							
16	6	10,9	7,6																																																							
20	7	8,7	5																																																							
24	8	6,63,61	4																																																							
27	9	4,59	3																																																							
29	9.5	57																																																								
31	10	55	2																																																							
32	10.5	53																																																								
34	11																																																									
35	11.5																																																									

Spark Plugs | Tabella di identificazione



IRIDIUM POWER® Serie Iridium Power (Power, Tough)

IDENTIFICAZIONE DELLE CANDELE DENSO																																															
I	U	27	A																																												
VF	KH	20																																													
Candela ad alte prestazioni	Diametro e lunghezza filettatura, dimensioni corpo metallico esagonale	Grado termico	Forma (tipo)																																												
I Iridio diametro 0.4 mm V Iridio diametro 0.4 mm con elettrodo in platino VF Iridio diametro 0.4 mm con elettrodo ad ago in platino (SIP)	<dim. filettatura x lungh. filett. x dimensione esagono (mm)> CH ... 12x26.5x14.0 K 14x19.0x16.0 KA ... 14x19.0 (Con copertura di protezione, nuovo elettrodo triplo)x16.0 KB ... 14x19.0 (Nuovi elettrodi tripli)x16.0 KBH ... 14x26.5 (Nuovi elettrodi tripli)x16.0 KD ... 14x19.0 (Con copertura di protezione)x16.0 KH ... 14x26.5x16.0 NH ... 10x19.0 (Mezza filettatura)x16.0 T 14x17.5 (Sede conica)x16.0 TF ... 14x11.2 (Sede conica)x16.0 TL ... 14x25.0 (Sede conica, isolatore lungo)x16.0 TV ... 14x25.0 (Sede conica)x16.0 Q 14x19.0x16.0 U 10x19.0x16.0 UF ... 10x12.7x16.0 UH ... 10x19.0 (Mezza filettatura)x16.0 W 14x19.0x20.6 WF ... 14x12.7x20.6 WM ... 14x19.0x20.6 (Isolatore compatto) X 12x19.0x18.0 XEH ... 12x26.5 (Copertura di protezione 2.0)x14.0 XG ... 12x19.0 (Copertura di protezione 3.0)x18.0 XU ... 12x19.0x16.0 XUH ... 12x26.5x16.0 Y 8x19.0 (Mezza filettatura)x13.0	<table border="1"> <thead> <tr> <th>DENSO</th> <th>NGK</th> <th>CHAMPION</th> <th>BOSCH</th> </tr> </thead> <tbody> <tr> <td>16</td> <td>5</td> <td>12,11</td> <td>8</td> </tr> <tr> <td>20</td> <td>6</td> <td>10,9</td> <td>7,6</td> </tr> <tr> <td>22</td> <td>7</td> <td>8,7</td> <td>5</td> </tr> <tr> <td>24</td> <td>8</td> <td>6,63,61</td> <td>4</td> </tr> <tr> <td>27</td> <td>9</td> <td>4,59</td> <td>3</td> </tr> <tr> <td>29</td> <td>9.5</td> <td>57</td> <td></td> </tr> <tr> <td>31</td> <td>10</td> <td>55</td> <td>2</td> </tr> <tr> <td>32</td> <td>10.5</td> <td>53</td> <td></td> </tr> <tr> <td>34</td> <td>11</td> <td></td> <td></td> </tr> <tr> <td>35</td> <td>11.5</td> <td></td> <td></td> </tr> </tbody> </table>	DENSO	NGK	CHAMPION	BOSCH	16	5	12,11	8	20	6	10,9	7,6	22	7	8,7	5	24	8	6,63,61	4	27	9	4,59	3	29	9.5	57		31	10	55	2	32	10.5	53		34	11			35	11.5			A Elettrodo inclinato, senza scanalatura a U, nessun taglio conico B Isolatore proiettato (1.5 mm) C Senza scanalatura a U D Senza scanalatura a U, elettrodo di massa Inconel E Copertura di protezione: 2 mm ES ... Guarnizione in acciaio inox: F Specifica speciale G Guarnizione in acciaio inox: I Posizione scintilla: 4 mm Isolatore proiettato (1.5 mm) J Posizione scintilla: 5 mm K Posizione scintilla: 4 mm Isolatore proiettato (2,5 mm) L Posizione scintilla: 5 mm T Per applicazioni GPL Y Gap 0.8 mm Z Taglio conico
DENSO	NGK	CHAMPION	BOSCH																																												
16	5	12,11	8																																												
20	6	10,9	7,6																																												
22	7	8,7	5																																												
24	8	6,63,61	4																																												
27	9	4,59	3																																												
29	9.5	57																																													
31	10	55	2																																												
32	10.5	53																																													
34	11																																														
35	11.5																																														

TT

IDENTIFICAZIONE DELLE CANDELE DENSO																			
I	W	16	TT																
	XEH	20	ETT																
Type of precious metal	Diametro e lunghezza filettatura, dimensioni corpo metallico esagonale	Grado termico	Forma (tipo)																
I Ø 0.4 mm in iridio con elettrodo in platino	<dim. filettatura x lungh. filett. x dimensione esagono (mm)> K 14x19.0x16.0 KBH ... 14x26.5 (Nuovi tripli elettrodi)x16.0 KH ... 14x26.5x16.0 Q 14x19.0x16.0 T 14x17.5 (Sede conica)x16.0 TF ... 14x11.2 (Sede conica)x16.0 TL ... 14x25.0 (Sede conica, isolatore lungo)x16.0 TV ... 14x25.0 (Sede conica)x16.0 W 14x19.0x20.6 WF ... 14x12.7x20.6 XEH ... 12x26.5 (Protezione 2.0)x14.0 XU ... 12x19.0x16.0 XUH ... 12x26.5x16.0	<table border="1"> <thead> <tr> <th>DENSO</th> <th>NGK</th> <th>CHAMPION</th> <th>BOSCH</th> </tr> </thead> <tbody> <tr> <td>16</td> <td>5</td> <td>12,11</td> <td>8</td> </tr> <tr> <td>20</td> <td>6</td> <td>10,9</td> <td>7,6</td> </tr> <tr> <td>22</td> <td>7</td> <td>8,7</td> <td>5</td> </tr> </tbody> </table>	DENSO	NGK	CHAMPION	BOSCH	16	5	12,11	8	20	6	10,9	7,6	22	7	8,7	5	E Protezione: 2 mm IXEH20ETT TT ... Nichel TT (Ø 1,5 mm elettrodo centrale, Ø 1,5 mm elettrodo di massa) W16TT TT ... Iridio TT (Ø 0,4 mm elettrodo centrale, Ø 0,7 mm elettrodo di massa) IW16TT I Posizione scintilla: 4 mm Sporgenza isolatore (1,5 mm) XUH20TTI
DENSO	NGK	CHAMPION	BOSCH																
16	5	12,11	8																
20	6	10,9	7,6																
22	7	8,7	5																



Gamma di candelette di preriscaldamento

Le candelette di preriscaldamento DENSO sono un'importante novità in termini di ricambi di qualità originale con una gamma multimarca; creata per offrire ai clienti Aftermarket una scelta alternativa con un marchio all'avanguardia in grado di soddisfare le esigenze dettate dalla crescente presenza di autoveicoli diesel sul mercato.

Si tratta di prodotti innovativi che traggono vantaggio dall'esperienza di DENSO Corporation, uno dei maggiori produttori mondiali di candelette di preriscaldamento originali per i più importanti fornitori del mercato automobilistico in tutto il mondo. Progettato secondo gli standard OE, il nostro programma per l'Aftermarket delle candele di preriscaldamento comprende ben 138 codici articolo che coprono oltre 4.800 applicazioni, ovvero l'equivalente del 98% del Parco Circolante Europeo. Le aggiunte attualmente in fase di sviluppo hanno il compito di migliorare ed aggiornare continuamente l'offerta.

Le candelette di preriscaldamento DENSO riuniscono tutte le più recenti tecnologie nel campo, come quelle a spirale singola, spirale doppia, esteso post-riscaldamento, in carmica e riscaldamento istantaneo.

Le candelette di preriscaldamento DENSO hanno le seguenti caratteristiche:

- > Candele di preriscaldamento di qualità originale che soddisfano o superano le specifiche dei produttori
- > Tempi di riscaldamento più rapidi e avviamento a freddo affidabile
- > Temperature di post-riscaldamento prolungate per emissioni ridotte
- > Ottima copertura e compatibilità con un gran numero di motori europei
- > Più applicazioni garantite da un numero inferiore di parti
- > Intuitivo sistema di numerazione delle parti
- > Conformità agli standard ISO TS16949, ISO14001 e OHSAS 18001

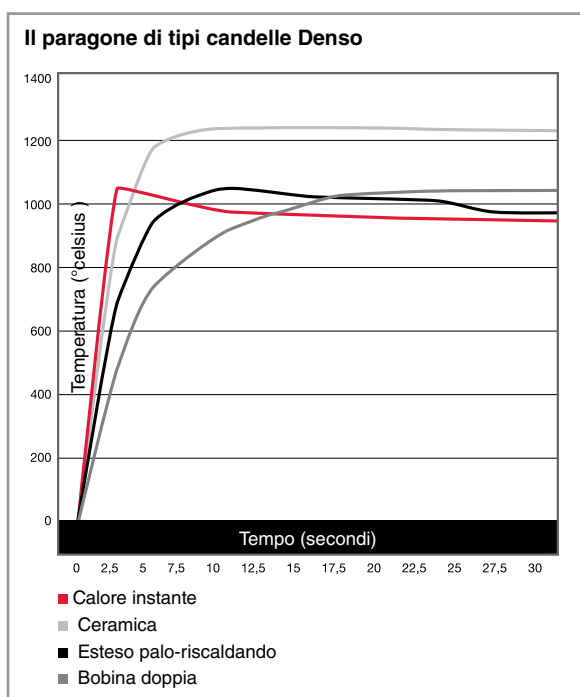

Come installare le candelette di preriscaldamento

Specifiche della coppia di serraggio consigliata per le candele Glow Plug DENSO:

1. Impiegare la chiave dinamometrica corretta per le candelette di preriscaldamento ed il morsetto.
2. Durante la fase di sostituzione delle candelette di preriscaldamento, assicurarsi che eventuali olio o sporcizie, etc., accumulati sull'esterno della candele di preriscaldamento smontata, non penetrino nel cilindro.
3. Durante il montaggio delle candelette di preriscaldamento, pulire il lato motore della flangia, ed assicurarsi che la candele di preriscaldamento sia allineata correttamente con la filettatura della testata dei cilindri.
4. Assicurarsi che la candela sia posizionata correttamente ed avvitata a mano, fino al punto in cui non può più essere ulteriormente serrata.
5. A questo punto, utilizzare una chiave dinamometrica per serrarla fino al valore di coppia illustrato nel diagramma sottostante.

SPECIFICHE DI COPPIA CONSIGLIATE PER L'INSTALLAZIONE		
Dimensione del filetto		Coppia consigliata
Candelette di preriscaldamento	M8x1.00	8-10 Nm
	M9x1.00	8-10 Nm
	M10x1.00	10-12 Nm
	M10x1.25	10-12 Nm
	M12x1.25	15-20 Nm
	M14x1.25	20-25 Nm
Terminale	M4x0.7	1-1.5 Nm
	M5x0.8	3-4 Nm



NON UTILIZZARE UN LUBRIFICANTE PER FILETTI!

Se sulla filettatura viene applicato uno strato di lubrificante per filetti, quale del grasso, la resistenza tra la candela Glow Plug e la testata dei cilindri sarà inferiore, e provocherà quindi un eccessivo serraggio.



Un serraggio superiore ai valori delle coppie illustrate nella tavola qui sopra potrebbe provocare danni alla Glow Plug ed al motore.



La causa più comune del guasto delle candelette di preriscaldamento sono le sovratensioni e/o il surriscaldamento. Le candelette di preriscaldamento sono progettate per funzionare a una temperatura di esercizio tra 850 e 1100 gradi. Se i tempi di erogazione della corrente elettrica alla candele di preriscaldamento sono troppo lunghi, per esempio per via di un relè o di un controllore difettoso, la candele si surriscalda e potrebbe essere soggetta a rigonfiamenti, spaccature o fenditure che provocherebbero il guasto immediato del veicolo. Pertanto si consiglia di controllare l'efficienza dell'intero impianto elettrico prima di sostituire le candele di preriscaldamento. L'eccessivo anticipo dell'iniezione, le perdite dagli iniettori o la benzina immessa nel motore possono causare l'eccessivo aumento della temperatura di combustione e danneggiare le candele di preriscaldamento. **Un relè difettoso può essere causa di guasto delle candele**, pertanto è necessario verificare l'intero sistema prima di sostituire le candele.



Il programma per l'alta tecnologia applicata alle candele di preriscaldamento

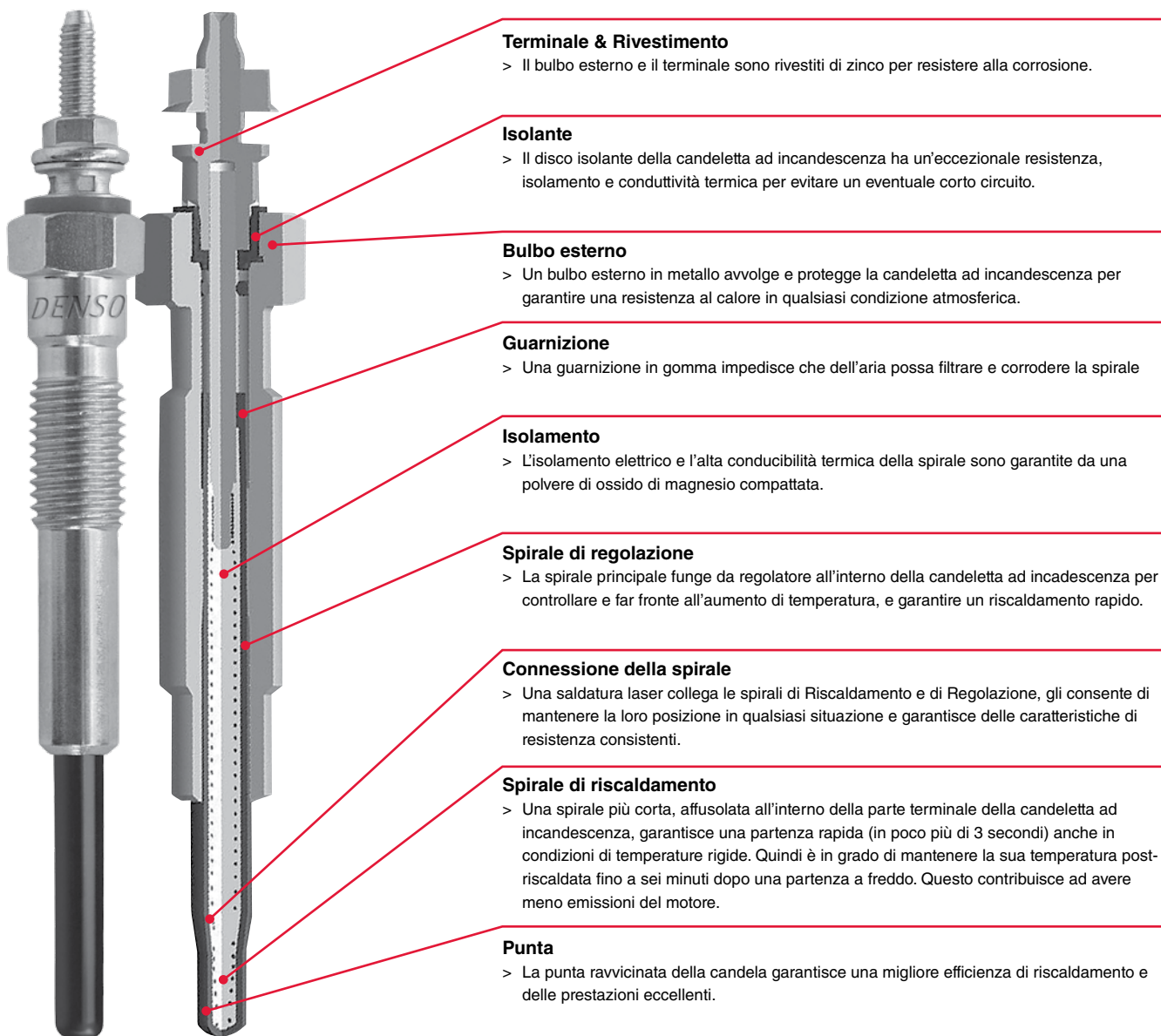

Skillnaden med DENSO

DENSO har satt standarden för tändstiftsteknologi sedan 1959. Vi utvecklar alla produkter själva och tillverkar dem i våra egna QS 9000- och ISO 9000-certifierade fabriker över hela världen – med 'noll fel' som standard. Vi tillhandahåller också den här enastående OE-kvaliteten till eftermarknaden. DENSO har en komplett serie tändstift med kontinuerligt uppdaterade produkter, som inkluderar Nickel, Platinum, Twin Tip och Iridium. Tändstiften från DENSO garanterar optimal motorprestanda och finns för alla små och stora bil-, motorcykel- och marinmotorer.

Produkter

Twin Tip (TT)

Nickel TT

- > Mittelektrod i nickellegering och 'dubbel' utskjutande sidoelektrod
- > Låga koldioxidutsläpp
- > Lägre bränsleförbrukning
- > Mjuk motorgång även under extrema förhållanden
- > Marknadens mest prisvärda prestandatändstift

Iridium TT

- > Förbättrad, pålitligare start
- > Förbättrad prestanda med upp till 20 % jämfört med traditionella tändstift i nickel
- > Livslängd på upp till 120 000 km
- > Förstklassig OEM-teknik nu tillgänglig till ett lägre pris för fler fordon
- > Bränslebesparingar

Direct Fit

Nickel

- > Kopparglastätning underlättar värmeavledning
- > Standard U-spår
- > Djupt infattad kopparkärna
- > Värmebeständig nickelplätning
- > Tändstift med flera sidoelektroder finns tillgängliga

Double Platinum (Longlife)

- > Förbättrad, pålitligare start
- > Fullständig förbränning (lägre utsläpp)
- > Förbättrad förmåga att klara felaktiga tändinställningar
- > Överlägsen gasrespons och acceleration
- > Tävlingsstad teknologi

Iridium Power

- > Superb tändkapacitet
- > Lågt spänningsbehov
- > Bättre gasrespons och driftstabilitet
- > Minskad bränsleförbrukning

Iridium Longlife, Iridium Tough

- > Superb tändkapacitet
- > Lågt spänningsbehov
- > Bättre gasrespons och driftstabilitet
- > Minskad bränsleförbrukning
- > Längre livslängd

Super Ignition Plug (SIP)

- > Ultratunn, höghållfast mitt- och jordelektrod
- > Senaste tändstiftsteknologin
- > OE-installerade i Honda, Hyundai, Kia, Lexus, Nissan, Mitsubishi, Mazda, Subaru, Toyota & Volvo
- > Högsta prestanda
- > Lång livslängd

Racing

Iridium Racing

- > F1-teknologi
- > Optimal acceleration
- > Hög tillförlitlighet
- > Extra prestanda

Informationen i denna katalog var giltig på utgivningsdagen. Se vår e-katalog för den mest aktuella informationen.

Rekommendationerna i denna katalog baseras på den senaste informationen från tillverkare för användning under normala förhållanden. Vi godtar inga rättsliga anspråk som uppstår ur innehållet i denna lista.

Korsreferenserna ska endast användas i vägledande syfte. Skillnader i utformning och material mellan tillverkare kan variera inom värmeintervallet. Se rekommendationsavsnittet för specifika motortillämpningar.

I de fall tillverkarens namn och/eller nummer har angivits, är dessa endast angivna i referenssyfte och visar inte var produkten har tillverkats och visar inte heller något annat samband vad gäller handel med namngivna tillverkare. För att hitta rätt tändstift i tabellen med korsreferenser, se artikelnumret för originaldelen och sedan motsvarande artikelnummer för DENSO.

Skillnaden med DENSO

Range	TT Range		Direct Fit							Racing
Material	Nickel	Iridium	Nickel	Platinum	Iridium					Iridium
Type	Nickel TwinTip	Iridium TwinTip	Nickel	Platinum	Iridium OEM ⁵	Iridium Long life ⁵	Iridium Power	Iridium Tough	SIP	Iridium Racing
U-spår	-	-	+ ¹	-	-	-	+ ²	-	-	-
Avfasad sidoelektrod	-	Vissa typer	Vissa typer ³	-	-	-	+ ²	-	Vissa typer	-
Material i sidoelektrod	Nickel-legering	Platinum-spets ⁶	Normal	Platinum-spets	Platinum-spets	Platinum-spets	Normal	Platinum-spets ⁷	Platinum-spets ⁶	Helt i Platinum
Mittelektrod	1.5 mm	0.55 mm	2.5 mm	1.1 mm	0.7 mm	0.4 mm	0.4 mm	0.4 mm	0.55 mm	0.4 mm ⁴
Värmeintervall	16-20	20-24	9-27	16-22	16-22	16-27	16-34	16-24	20-24	24-35
Resistor	Alla typer	Alla typer	De flesta typer	Alla typer	Alla typer	Alla typer	Alla typer	Alla typer	Alla typer	Alla typer
Högprestanda	+++	+++++	+	++	++++	++++	++++	++++	+++++	+++++
Bränsleekonomi	Bättre	Bäst	Bra	Bättre	Bäst	Bäst	Bäst	Bäst	Bäst	-
Livslängd	Standard	Lång livslängd	Standard	Lång livslängd	Lång livslängd	Lång livslängd	Standard	Lång livslängd	Lång livslängd	Endast för tävling

¹ Tändstift utan ett 'U' i typnamnet har inte U-spår

² Gäller ej IU24A, IU27A, IU31A, IUF27A och IUF31A

³ Tändstift med ett 'Z' i typnamnet har en avfasad sidoelektrod

⁴ Utom för tändstiftstyper med ytgap

⁵ OEM-typer, endast för vissa fordon

⁶ Platinanål 0.7 mm

⁷ Platinanål 0.7 mm finns tillgänglig

Installation av tändstift

Rekommenderat moment och åtdragningsvinkel för DENSO tändstift.

1. Använd rätt tändstiftsnyckel till sexkantsmuttern på stiftet och var försiktig så att du inte skadar isolatorn.
2. Torka av olja osv. på utsidan av tändstiftet vid byte, så att det inte kommer in i motorn.
3. Rengör motorsidan av flänsen innan stiftet sätts i och kontrollera att tätningbrickan sitter rätt i flänsen innan du sätter i stiftet.
4. Se till att tändstiftet sitter vertikalt och dra fast dem för hand tills de inte går att dra åt mer (A+B)
5. Använd sedan en momentnyckel för att dra åt till korrekt momentvärde enligt tabellen nedan. Du kan även använda en tändstiftsnyckel och dra åt till rekommenderade varv. Mer information om absolut momentvärde hittar du i vår e-katalog (C+D).

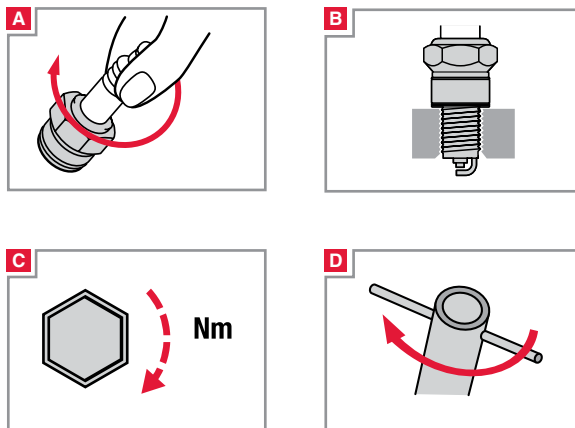

REKOMMENDERAD INSTALLATION ÅTDRAGNINGSMOMENT					
Gängdiameter		Rekommenderat moment	Rekommenderat Varv		
			Nytt stift	Använt varv	
Tätningbricka	M8 Y-typ	8-10 Nm	± 1 varv	± 1/12 varv	
	M10 U, N-typ	10-15 Nm	± 2/3 varv	± 1/12 varv	
	M10 Rostfri stältätningbricka	10-15 Nm	± 3/4 varv	± 1/12 varv	
	M12 SXU, X, XE, XU, ZXE, ZXU-typ	15-20 Nm	± 1/3 varv	± 1/12 varv	
	M14 FK, J, K, KJ, P, PK, PKJ, PQ, Q, QJ, QL, S, SF, SK, SKJ, SV, SVK, VK, VKJ, W, ZT-typ	20-25 Nm	± 1/2 varv	± 1/12 varv	
	M14 Rostfri stältätningbricka	20-25 Nm	± 2/3 varv	± 1/12 varv	
	M18 L, M, MA, MW-typ	30-40 Nm	± 1/4 varv	± 1/12 varv	
Konformat säte	M14 PT, PTJ, T-typ	20-30 Nm	± 1/16 varv	± 1/16 varv	
	M18 MA-typ	30-40 Nm	± 1/4 varv	± 1/12 varv	



Om gängsmörjning, som smörjfett, applicerats på gängorna ska stiftet inte dras åt till rekommenderat moment. Detta kan medföra läckage i tätningen. Använd inte gängsmörjning.

Åtdragning till mer än de åtdragningsvinklar och – moment som visas i ovanstående tabell kan leda till skada på motorn och att stiftet lossar från gängorna.

SE

Tändstiftsegenskaper

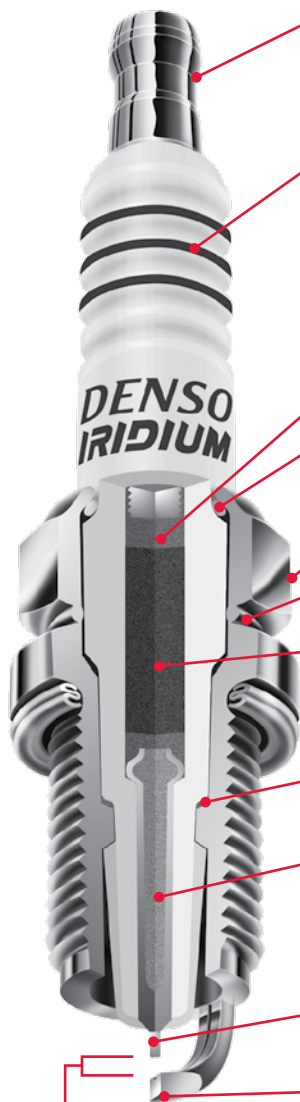

Anslutning

- > Gängad, avtagbar, veckad eller fast

Keramisk isolator

- > Konstruktionen med fem räfflor som täcker hela ytan
- > Detta minskar spänningsförlusterna och förhindrar uteblivna gnistor
- > Högre aluminium används
- > God elektrisk isolering, tillförlitlighet och värmeledning
- > Kemiskt stabil

Ring

Speciell koppar-glastätning

- > God lufttätethet, tillförlitlighet och värmeledning.

Stomme

- > En mycket korrosionsbeständig nickelplätning

Elektrisk värmätning

- > Värmebeständighet, ger god täthet och litet värmevariationsintervall.

Resistor

- > En resistor på 5 kW ger mindre radiobrus.

Tätning

Mittelektrod med kopparkärna

- > Jämfört med andra tillverkare använder DENSO mer koppar vilket ger bättre värmeegenskaper
- > En stark, stabil gnista från låga upp till höga hastigheter.

Mittelektrod

- > Mittelektroden i DENSO:s Iridium-stift har världens minsta diameter på endast 0,4 mm

Jordelektrod

- > Med U-spår, vilket ger en fullständigare förbränning
- > Avfasningen resulterar i en stabil tändning.
- > Finns med platinaspets för längre livslängd
- > Finns med nålspets för optimal tändkapacitet

Gnistgap

- > De flesta tändstift från DENSO har förinställt gnistgap vilket innebär att du inte behöver ställa in gnistgapet själv.

Spark Plugs | Identifieringstabell

SE



Iridium-stift / platina / Nickel tändstift

IDENTIFIERA TÄNDSTIFT FRÅN DENSO																																																										
	W	16	E	XR	-U	11																																																				
S	K	20		PR	-A	11																																																				
S	XU	22	H	CR	-11S																																																					
Typ av ädelmetall	Gängdiameter och nyckeldimension	Värmetal	Längd	Form (typ)	Form (typ)	Gnistgap																																																				
D ... Iridium, platinanål med 0.7 mm diameter (SIP)	C 12x14.0	<table border="1"> <tr> <th>DENSO</th> <th>NGK</th> <th>CHAMPION</th> <th>BOSCH</th> </tr> <tr> <td>4</td> <td></td> <td></td> <td></td> </tr> <tr> <td>9</td> <td>2</td> <td>18</td> <td>10</td> </tr> <tr> <td>14</td> <td>4</td> <td>16,14</td> <td>9</td> </tr> <tr> <td>16</td> <td>5</td> <td>12,11</td> <td>8</td> </tr> <tr> <td>20</td> <td>6</td> <td>10,9</td> <td>7,6</td> </tr> <tr> <td>22</td> <td>8</td> <td>6,63,61</td> <td>4</td> </tr> <tr> <td>27</td> <td>9</td> <td>4,59</td> <td>3</td> </tr> <tr> <td>29</td> <td>9.5</td> <td>57</td> <td></td> </tr> <tr> <td>31</td> <td>10</td> <td>55</td> <td>2</td> </tr> <tr> <td>32</td> <td>10.5</td> <td>53</td> <td></td> </tr> <tr> <td>34</td> <td>11</td> <td></td> <td></td> </tr> <tr> <td>35</td> <td>11.5</td> <td></td> <td></td> </tr> </table>	DENSO	NGK	CHAMPION	BOSCH	4				9	2	18	10	14	4	16,14	9	16	5	12,11	8	20	6	10,9	7,6	22	8	6,63,61	4	27	9	4,59	3	29	9.5	57		31	10	55	2	32	10.5	53		34	11			35	11.5			A 19.0 mm (Gnistläge: 7.0 mm) J16AR-U11	A Dubbla sidoelektroder W22EA	-A ... Specialmodell SK16PR-A11	5 0.5 mm (.020")
	DENSO		NGK	CHAMPION	BOSCH																																																					
4																																																										
9	2	18	10																																																							
14	4	16,14	9																																																							
16	5	12,11	8																																																							
20	6	10,9	7,6																																																							
22	8	6,63,61	4																																																							
27	9	4,59	3																																																							
29	9.5	57																																																								
31	10	55	2																																																							
32	10.5	53																																																								
34	11																																																									
35	11.5																																																									
F Iridium, platinanål med 0.55 mm diameter (SIP)	L 18x22.2 (Längd: 12.7 mm)		A 21.5 mm S29A	AY .. Dubbla , böjda sidoelektroder J16AY	-B ... Specialmodell K16PSR-B8	8 0.8 mm (.032")																																																				
P Platina, platinaspets med 1.1 mm diameter	M 18x25.4 (Längd: 12 mm)		B 19.0 mm (Gnistläge: 9.5 mm) J16BR-U	B ... Tre sidoelektroder W22EB	-C ... Avskurna sidoelektroder W27EMR-C	9 0.9 mm (.035")																																																				
S Iridium, platinaspets med 0.7 mm diameter	MA 18x20.6 (Konat säte, längd: 12 mm)		C 19.0 mm (Gnistläge: 5.0 mm) KJ20CR-L11	BG... Tre sidoelektroder (hölje) SK20BGR11	-D ... Sidoelektrod med kopparkärna DK20PR-D13	10 1.0 mm (.040")																																																				
SV ... Iridium, platinaspets med 0.4 mm diameter	MW 18x20.6 (Längd: 12 mm)		D 19.0 mm (Hölje 2) K20DTR-S11	C ... Hölje 1.5 mm SXU22HCR11	-E ... Specialmodell SK16PR-E11	11 1.1 mm (.044")																																																				
Z Iridium, platinaspets med 0.55 mm diameter	J 14x20.6 (Utskjutande stift)		E (Med packning) ... 19.0 mm W16EX-U	D 4 sidoelektroder W27EDR	-F ... Specialmodell SK16PR-F11	12 1.2 mm (.047")																																																				
	K 14x16.0 (Miniatyrstift)		E (Med packning) ... 20.0 mm W25EBR	D Utskjutande (1.5 mm, gnistläge 3.5 mm) XU22HDR9	-G ... Fettbestrukna gängor för CNG SK20R8-G	13 1.3 mm (.050")																																																				
	KJ 14x16.0 (Utskjutande miniatyrstift)		E (Konat säte) ... 19.0 mm T16EPR-U	E Hölje 2.0 mm FXE20HE11	-GL ... Mittelektrod av platina X22EPR-GL	14 1.4 mm (.055")																																																				
	LP 14x20.6 (Tändstift för gasmotorer)		F 12.7 mm W20FP-U	K ... Utskjutande (1 mm) W16EKR-S11	-L ... Värmetålig sidoelektrod K20PR-L11	15 1.5 mm (.060")																																																				
	Q 14x16.0 (Miniatyrstift)		FE 19.0 mm (Halv gänga) U24FER9	LM... Kompakt (nyckelvidd 20.6 mm) W14LM-U	-L ... 3.5 mm utskjutande isolator för motorcyklar W20FP-UL	<Inget>																																																				
	QJ 14x16.0 (Utskjutande miniatyrstift)		G 19.0 mm (Hölje 3.5) PK20GR8	M Förkortat isolatorhuvud W27EMR-C	-L ... Indragen isolator för motorcyklar W20FR-L	Bilar: 0.8 mm M/C: 0.7 mm																																																				
	QL 14x20.6 (Miniatyrstift med långt cylindrehölje)		G 19.0 mm (Hölje 3) X27GPR-U	M Kompakt (nyckelvidd 19.0 mm) W20M-U	-M ... Större jordisolator SK20PR-M11S	<Undantag>: P16R, PQ16R, PQ20R är 1.1 mm																																																				
	S 14x20.6 (Stift med ytliggande gnistgap (för RE-motorer))		H 26.5 mm QJ16HR-U	P Utskjutande (1.5 mm) W16EP-U	-N ... För Yamaha och Kawasaki U27ESR-N																																																					
	T 14x16.0 (Konat säte)		H 19.0 mm (Gnistläge: 8.5 mm) K16HPR-U11	Q ... Utskjutande 2 mm, gnistläge 3.5 mm	-P ... Dubbla sidoelektroder i platina SK20R-P11																																																					
	W 14x20.6 (Kompakttyp)		L 11.2 mm W14L	R ... 5 kOhm motstånd K16R-U	-P ... Enkelsidigt platinastift K16PR-P11																																																					
	X 12x18.0		N (Konat säte, Halv gänga) 17.5 mm T20NR-U11	S Ej utskjutande (0 mm) W22ES-U	-R ... 10 kOhm motstånd K22PR-UR																																																					
	XE 12x14.0		V (Konat säte) ... 25.0 mm PT16VR13	S Iridium på en sida KJ20SR11	-S ... Gnistgap med semi-yta W20EP-S11																																																					
	XU 12x16.0		Inget ... 9.5 mm W14M-U 11.2 mm L14-U, M24S 19.0 mm SK20R11 21.5 mm S29A	T Dubbla sidoelektroder K16TR11	-S ... Rostfri packning U27FER9S																																																					
	N 10x16.0		Inget (Konat säte) ... 8.3 mm T20M-U 11.2 mm T16PR-U	TM ... Dubbla sidoelektroder K22TMR11	-T ... För gasmotorer SK20HR8-T																																																					
	U 10x16.0			TN ... Dubbla sidoelektroder K22TNR-S	-T ... Specialmodell FK20HBR11-T																																																					
	Y 8x13.0			X Fullt utskjutande (2.5 mm) W16EX-U	-TP ... Konat enkelsidigt platinastift K20PR-TP11																																																					
					-U ... Elektrod med U-spår K16PR-U																																																					
					-US ... Stjärnformad mittelektrod W20M-US																																																					
					-V ... Mittelektrod, nickelkärna med 1.3 mm diameter W27ES-V																																																					

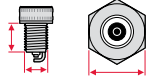

Spark Plugs | Identifieringstabell

SE

IRIDIUMPOWER® Iridium Power-serien (Power, Tough)

IDENTIFIERA TÄNDSTIFT FRÅN DENSO																																															
I	U	27	A																																												
VF	KH	20																																													
																																															
Högpresandastift	Gängdiameter, längd och nyckelvidd	Värmetal																																													
I..... Iridium med 0.4 mm diameter V..... Iridium med 0.4 mm diameter och platinaspets VF... Iridium med 0.4 mm diameter och platinaspets av nåltyp (SIP)	<Gängdiameter x längd x nyckelvidd (mm)> CH... 12x26.5x14.0 K... 14x19.0x16.0 KA... 14x19.0 (Nya, tre elektroder med hölje)x16.0 KB... 14x19.0 (Nya, tre elektroder)x16.0 KBH... 14x26.5 (Nya, tre elektroder)x16.0 KD... 14x19.0 (Med hölje)x16.0 KH... 14x26.5x16.0 NH... 10x19.0 (Halv gänga)x16.0 T... 14x17.5 (Konat säte)x16.0 TF... 14x11.2 (Konat säte)x16.0 TL... 14x25.0 (Konat säte, lång isolator)x16.0 TV... 14x25.0 (Konat säte)x16.0 Q... 14x19.0x16.0 U... 10x19.0x16.0 UF... 10x12.7x16.0 UH... 10x19.0 (Halv gänga)x16.0 W... 14x19.0x20.6 WF... 14x12.7x20.6 WM... 14x19.0x20.6 (Kompakt isolator) X... 12x19.0x18.0 XEH... 12x26.5 (Hölje 2.0)x14.0 XG... 12x19.0 (Hölje 3.0)x18.0 XU... 12x19.0x16.0 XUH... 12x26.5x16.0 Y... 8x19.0 (Halv gänga)x13.0	<table border="1"> <thead> <tr> <th>DENSO</th> <th>NGK</th> <th>CHAMPION</th> <th>BOSCH</th> </tr> </thead> <tbody> <tr> <td>16</td> <td>5</td> <td>12,11</td> <td>8</td> </tr> <tr> <td>20</td> <td>6</td> <td>10,9</td> <td>7,6</td> </tr> <tr> <td>22</td> <td>7</td> <td>8,7</td> <td>5</td> </tr> <tr> <td>24</td> <td>8</td> <td>6,63,61</td> <td>4</td> </tr> <tr> <td>27</td> <td>9</td> <td>4,59</td> <td>3</td> </tr> <tr> <td>29</td> <td>9.5</td> <td>57</td> <td></td> </tr> <tr> <td>31</td> <td>10</td> <td>55</td> <td>2</td> </tr> <tr> <td>32</td> <td>10.5</td> <td>53</td> <td></td> </tr> <tr> <td>34</td> <td>11</td> <td></td> <td></td> </tr> <tr> <td>35</td> <td>11.5</td> <td></td> <td></td> </tr> </tbody> </table>		DENSO	NGK	CHAMPION	BOSCH	16	5	12,11	8	20	6	10,9	7,6	22	7	8,7	5	24	8	6,63,61	4	27	9	4,59	3	29	9.5	57		31	10	55	2	32	10.5	53		34	11			35	11.5		
DENSO	NGK	CHAMPION	BOSCH																																												
16	5	12,11	8																																												
20	6	10,9	7,6																																												
22	7	8,7	5																																												
24	8	6,63,61	4																																												
27	9	4,59	3																																												
29	9.5	57																																													
31	10	55	2																																												
32	10.5	53																																													
34	11																																														
35	11.5																																														
		Form (typ)																																													
		A..... Snedställd elektrod, inget U-spår, ingen koning B..... Utskjutande isolator (1.5 mm) C..... Inget U-spår D..... Inget U-spår, Inconelsidoelektrod E..... Hölje: 2 mm ES... Packning av rostfritt stål F..... Specialmodell G..... Packning av rostfritt stål I..... Gnisläge: 4 mm Utskjutande isolator (1.5 mm) J..... Gnisläge: 5 mm K..... Gnisläge: 4 mm Utskjutande isolator (2.5 mm) L..... Gnisläge 5 mm T..... För gasmotorer Y..... 0.8 mm elektrodavstånd Z..... Konat																																													

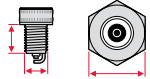
TT

IDENTIFIERA TÄNDSTIFT FRÅN DENSO																			
I	W	16	TT																
	XEH	20	ETT																
																			
Type of precious metal	Gängdiameter, längd och nyckelvidd	Värmetal																	
I..... Iridium, platinanål med 0.4 mm diameter	<Gängdiameter x längd x nyckelvidd (mm)> K... 14x19.0x16.0 KBH... 14x26.5 (Nya tripplelektroder)x16.0 KH... 14x26.5x16.0 Q... 14x19.0x16.0 T... 14x17.5 (Konat säte)x16.0 TF... 14x11.2 (Konat säte)x16.0 TL... 14x25.0 (Konat säte, lång isolator)x16.0 TV... 14x25.0 (Konat säte)x16.0 W... 14x19.0x20.6 WF... 14x12.7x20.6 XEH... 12x26.5 (Hölje 2.0)x14.0 XU... 12x19.0x16.0 XUH... 12x26.5x16.0	<table border="1"> <thead> <tr> <th>DENSO</th> <th>NGK</th> <th>CHAMPION</th> <th>BOSCH</th> </tr> </thead> <tbody> <tr> <td>16</td> <td>5</td> <td>12,11</td> <td>8</td> </tr> <tr> <td>20</td> <td>6</td> <td>10,9</td> <td>7,6</td> </tr> <tr> <td>22</td> <td>7</td> <td>8,7</td> <td>5</td> </tr> </tbody> </table>		DENSO	NGK	CHAMPION	BOSCH	16	5	12,11	8	20	6	10,9	7,6	22	7	8,7	5
DENSO	NGK	CHAMPION	BOSCH																
16	5	12,11	8																
20	6	10,9	7,6																
22	7	8,7	5																
		Form (typ)																	
		E..... Hölje: 2 mm IXEH20ETT TT... Nickel TT (mitt- och jordelektrod med 1.5 mm diameter) W16TT TT... Iridium TT (mittelektrod med 0.4 mm diameter, jordelektrod med 0.55 mm diameter) IW16TT I..... Gnisläge: 4 mm Utskjutande isolator (1.5 mm) XUH20TTI																	

Glödstiftssortiment

DENSO:s glödstiftsprogram är ett framstående nytt initiativ av OE-kvalitet för alla märken, framtaget för att erbjuda eftermarknadens kunder ett alternativ av märkeskvalitet för deras växande dieselbehov.

Det avancerade programmet drar fördel av DENSO:s bakgrund som världsledande OE-tillverkare av glödstift för framstående fordonsfabrikanter över hela världen. Vårt glödstiftsprogram till eftermarknaden är konstruerat efter OE-standard och omfattar 138 artiklar som täcker mer än 4.800 tillämpningar; tillräckligt för 98% av Europas fordonspark. Fortgående kompletteringar är planerade för att ständigt bredda och uppdatera programmet.

DENSO:s glödstiftsprogram omfattar alla nuvarande glödstiftstekniker inklusive enkelspole, dubbelspole, förlängd eftervärme, keramiska glödstift och direkt uppvärmning.

DENSO glödstift ger:

- > Glödstift av OE-kvalitet som möter eller överträffar tillverkarnas specifikationer
- > Snabbare upphettningstider och pålitlig kallstart.
- > Förhöjda eftervärmningstemperaturer för lägre utsläpp
- > Utmärkt täckning garanterar tillämpning till nästan varje dieselmotor i Europa
- > Fler tillämpningar med färre artikelnummer
- > Lättanvänt system av artikelnummer
- > Möter kraven ställda i ISO TS16949, ISO14001 samt OHSAS 18001 standarderna

Installation av glödstift

Rekommenderade vridmoment för DENSO glödstift:

1. Använd rätt typ och storlek på nyckeln för glödstiftet.
2. När du byter glödstift, försäkra dig om att olja, smuts med mera på det gamla glödstiftet inte kommer in i cylindern.
3. När du ska montera det nya glödstiftet, rengör motorsidan på flänsen och kontrollera att glödstiften ligger i rätt vinkel mot gängan i cylindern.
4. Kontrollera att glödstiftet går korrekt i gängan och dra åt med handkraft tills det inte kan dras mer.
5. Använd sedan en momentnyckel för att dra åt glödstiftet korrekt enligt det dragmoment som visas i tabellen nedanför.

INSTALLATIONSANVISNINGAR FÖR DENSO GLÖDSTIFT		
	Gängstorlek	Rekommenderat åtdragningsmoment
Glödstift	M8x1.00	8-10 Nm
	M9x1.00	8-10 Nm
	M10x1.00	10-12 Nm
	M10x1.25	10-12 Nm
	M12x1.25	15-20 Nm
	M14x1.25	20-25 Nm
Terminal	M18x1.50	30-40 Nm
	M4x0.7	1-1.5 Nm
	M5x0.8	3-4 Nm

Jämförelse av DENSO glödstiftstyper

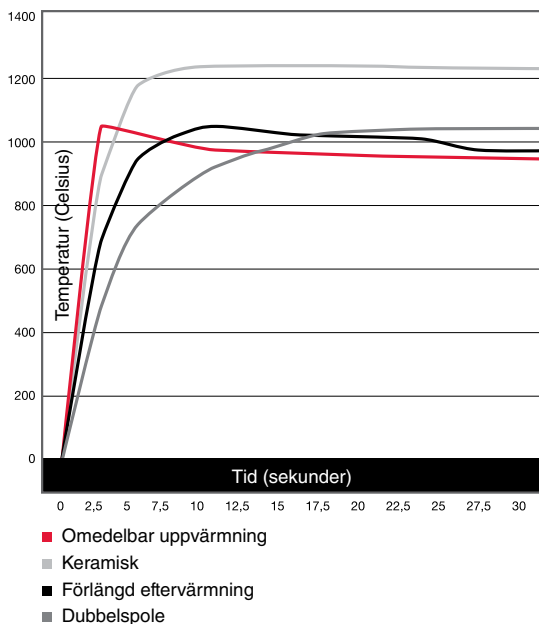

ANVÄND INGET SMÖRJMEDEL! Om ett smörjmedel, exempelvis fett, läggs på gängan kommer motståndet mellan glödstiftet och cylinderhuvudet att minska – detta resulterar i för hårt dragna glödstift.



Att dra stiften hårdare än vad som visas i tabellen ovan kan resultera i skador både på glödstiftet och motorn!



Glödstiftsfel orsakas oftast av för hög spänning och/eller värme. Glödstift är konstruerade för att arbeta i mellan 850 till 1100 grader.

Om elströmmen till glödstiftet aktiveras för länge pga. fel på ett relä och/eller styrenheten, kan det leda till överhettning som gör att glödstiftet vidgas, spricker, eller splittras, vilket orsakar omedelbart haveri. Därför rekommenderas att hela elsystemet kontrolleras före isättning av ett nytt glödstift.

För tidig bränsleinsprutning, läckande insprutningsmunstycken, eller bensen i motorn gör att förbränningstemperaturen blir för hög och att glödstiften skadas. **Ett dåligt relä och tändsystem kan också orsaka trasiga glödstift**, så det är rekommenderat att i samband med byte kontrollera hela tändsystemet.

SE

Ritningen på en överlägsen glödstiftsteknologi

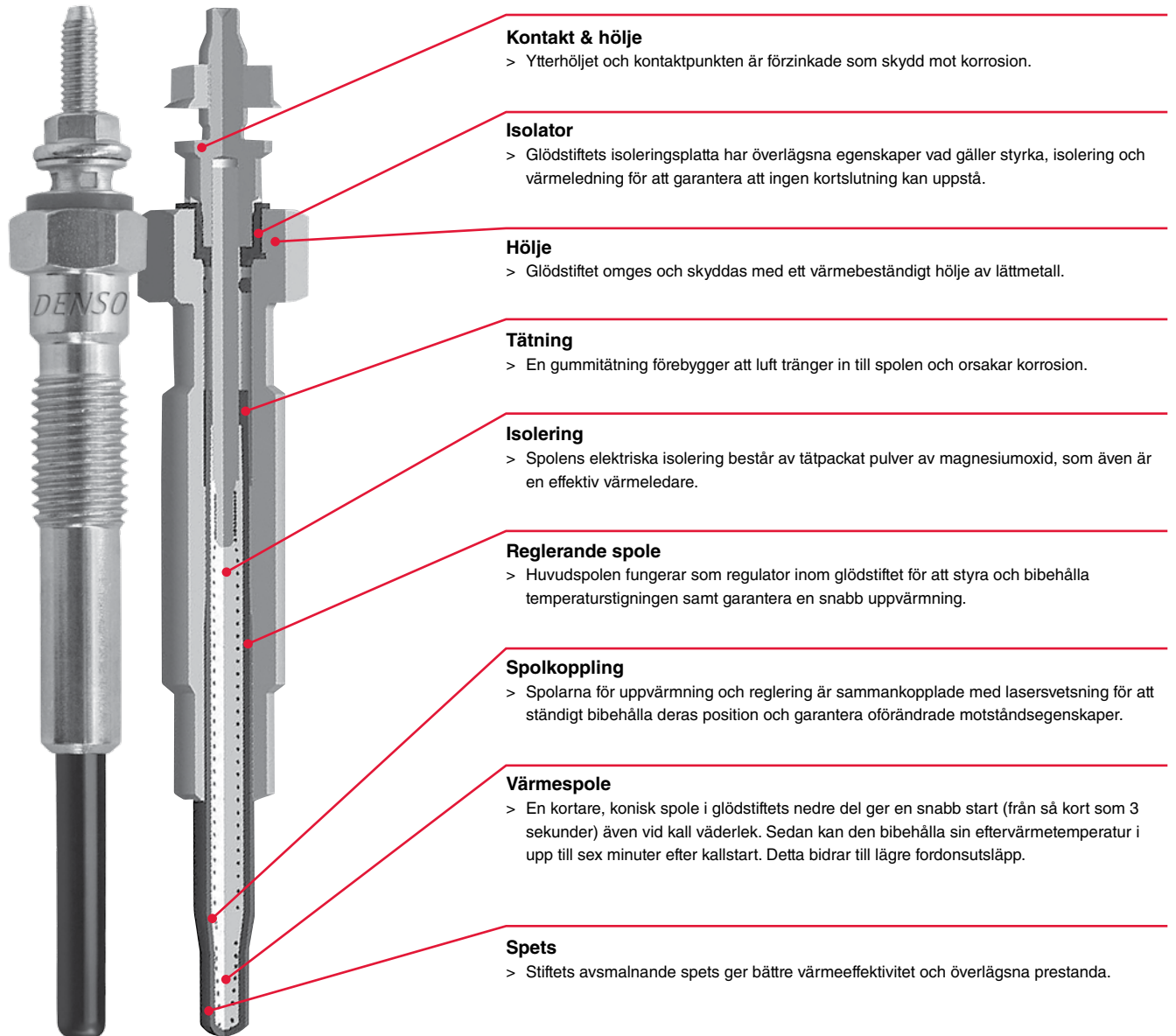

Różnica DENSO

DENSO wyznacza standardy dla technologii świec zapłonowych od 1959 roku. Wszystkie typoszeregi naszych produktów opracowujemy w firmie i produkujemy we własnych fabrykach z certyfikatami QS 9000 ISO 9000 - przestrzegając normy "zero usterek". Tę wyjątkową jakość OE dostarczamy również na rynek wtórny. Oferta świec zapłonowych DENSO, w której skład wchodzi świece niklowe, platynowe, irydowe, świece TT obejmuje cały zakres ciągle aktualizowanych pozycji. Wybierz świece zapłonowe DENSO, które gwarantują wysokie osiągi silnika dla każdego samochodu, motocykla, łodzi i innych urządzeń z małymi silnikami

Zakres

Twin Tip (TT)

Niklowe TT

- > Cienka elektroda środkowa ze stopu niklowego oraz cienka wysunięta elektroda masy
- > Niska emisja dwutlenku węgla
- > Zmniejszone zużycie paliwa
- > Płynna praca silnika, nawet w ekstremalnych warunkach
- > Najbardziej opłacalne świece zapłonowe o wysokich osiągnięciach

Iridium TT

- > Lepszy, bardziej niezawodny rozruch
- > Lepsza wydajność działania – nawet do 20% w porównaniu do świec niklowych
- > Żywotność ok. 120.000 km
- > Wyjątkowa technologia OEM teraz dostępna w niższej cenie dla szerszej gamy pojazdów
- > Oszczędność paliwa

Informacje zawarte w niniejszym katalogu są zgodne z datą jego wydania. W poszukiwaniu najbardziej aktualnych informacji, prosimy o skorzystanie z naszego e-katalogu.

Zawarte w tym katalogu rekomendacje są oparte o najnowsze informacje przekazane przez producentów pojazdów i dotyczą eksploatacji w standardowych warunkach. Nie akceptujemy roszczeń prawnych wynikających z treści niniejszej listy.

Informacje dotyczące zamienników powinny być traktowane wyłącznie jako wskazówki. Różnice konstrukcyjne i materiałowe pomiędzy poszczególnymi producentami mogą powodować różnice w zakresach cieplnych. Sprawdź sekcję rekomendacji dla konkretnych zastosowań silników.

Podane w niektórych miejscach nazwy i/lub numery producentów mają charakter referencyjny i nie wskazują na miejsce wytwarzania ani na żadne inne powiązanie handlowe z wymienionymi producentami. W celu znalezienia właściwej świecy zapłonowej należy zapoznać się z oryginalnym numerem danej części (OEM) i znaleźć jej odpowiednik DENSO w tabeli zamienników.

Typoszeregi świec zapłonowych DENSO dla zastosowań OEM

Niklowe

- > Uszczelka miedziano-szklana poprawia rozproszenie ciepła
- > Standardowy rowek U
- > Głęboko umieszczony rdzeń miedziany
- > Termoodporna powłoka niklowa
- > Dostępne świece zapłonowe z wieloma elektrodami masowymi

Double Platinum (o wydłużonej żywotności)

- > Lepszy, bardziej niezawodny rozruch
- > Pełniejsze spalanie (niższa emisja)
- > Poprawiona zdolność kompensacji usterek regulacji silnika
- > Doskonała reakcja przepustnicy i przyspieszenie
- > Technologia sprawdzona w wyścigach

Iridium Power

- > Doskonały zapłon
- > Niskie wymagane napięcie
- > Lepsza reakcja podczas przyspieszania i stabilność pracy
- > Zmniejszone zużycie paliwa

Iridium Longlife, Iridium Tough

- > Doskonały zapłon
- > Niskie wymagane napięcie
- > Lepsza reakcja podczas przyspieszania i stabilność pracy
- > Zmniejszone zużycie paliwa
- > Dłuższa żywotność

Super Ignition Plug (SIP)

- > Dwie bardzo cienkie, bardzo trwałe elektrody - środkowa i masy
- > Najnowocześniejsza technologia świec zapłonowych
- > Montowane jako OE w samochodach Honda, Hyundai, Kia, Lexus, Nissan, Mitsubishi, Mazda, Subaru, Toyota i Volvo
- > Najwyższe osiągi
- > Długa żywotność

Racing i inne zastosowania

Iridium Racing

- > Technologia F1
- > Najwyższe przyspieszenie
- > Wysoka niezawodność
- > Podwyższone osiągi

Różnica DENSO

Zakres	Świece TT		Typszeregi świec zapłonowych DENSO dla zastosowań OEM							Racing i inne
Materiał	Nikiel	Iryd	Nikiel	Platyna	Iryd					Iryd
Typ	Niklowe TwinTip	Irydowe TT	Niklowe	Platynowe	Iridium OEM ⁵	Iridium Long life ⁵	Iridium Power	Iridium Tough	SIP	Iridium Racing
Rowek U	-	-	+ ¹	-	-	-	+ ²	-	-	-
Elektroda masy ścięta stożkowo	-	Niektóre typy	Niektóre typy ³	-	-	-	+ ²	-	Niektóre typy	-
Materiał a elektroda masy	Stop niklowy	Końcówka platynowa ⁶	Normalna	Końcówka platynowa	Końcówka platynowa	Końcówka platynowa	Normalna	Końcówka platynowa ⁷	Końcówka platynowa ⁶	Cała platynowa
Elektroda środkowa	1.5 mm	0.55 mm	2.5 mm	1.1 mm	0.7 mm	0.4 mm	0.4 mm	0.4 mm	0.55 mm	0.4 mm ⁴
Wartość cieplna	16-20	20-24	9-27	16-22	16-22	16-27	16-34	16-24	20-24	24-35
Rezystor	Wszystkie typy	Wszystkie typy	Większość typów	Wszystkie typy	Wszystkie typy	Wszystkie typy	Wszystkie typy	Wszystkie typy	Wszystkie typy	Wszystkie typy
Podwyższone parametry	+++	+++++	+	++	++++	++++	++++	++++	+++++	+++++
Oszczędność paliwa	Lepsza	Najlepsza	Dobra	Lepsza	Najlepsza	Najlepsza	Najlepsza	Najlepsza	Najlepsza	-
Żywotność	Standardowa	Przedłużona	Standardowa	Przedłużona	Przedłużona	Przedłużona	Przedłużona	Przedłużona	Przedłużona	Wyłącznie do wyścigów

¹ Świece zapłonowe bez litery U w kodzie nie mają na elektrodzie rowka U

² Nie dotyczy IU24A, IU27A, IU31A, IUF27A i IUF31A

³ Świece zapłonowe z literą Z w kodzie mają elektrodę masy ze ścięciem stożkowym

⁴ Z wyjątkiem świec z wyładowaniem powierzchniowym

⁵ Typy OEM, tylko dla określonych pojazdów

⁶ Dostępne świece irydowe Double Needle

⁷ Dostępne z platynową igłą 0.7mm

MONTAŻ ŚWIECY ZAPŁONOWEJ

Zalecane momenty i kąty dokręcania dla świec zapłonowych DENSO

1. Używać właściwego klucza do sześciokątnego elementu korpusu świecy i zachować ostrożność, aby nie uszkodzić izolatora.
2. Podczas wymiany zadbać o to, aby olej itp. substancje znajdujące się na zewnątrz świecy nie dostały się do silnika.
3. Przy wkładaniu świecy, oczyścić kołnierz od strony silnika i włożyć świecę po uprzednim sprawdzeniu, że w kołnierzu znajduje się uszczelka.
4. Upewnić się, że świece są ustawione pionowo i dokręcić je ręką do oporu (A+B).
5. Następnie użyć klucza dynamometrycznego, aby dokręcić je dokładnie zalecanym momentem, zgodnie z poniższą tabelą. Jeśli klucz dynamometryczny nie jest dostępny, użyć klucza do świec zapłonowych, aby dokręcić świecę o kąt podany w poniższej tabeli (C+D). Więcej informacji na temat momentu obrotowego można znaleźć w naszym e-katalogu.

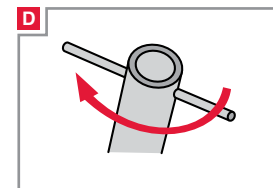
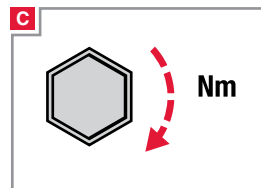
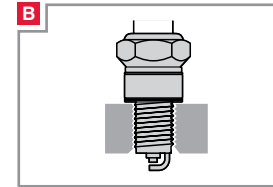
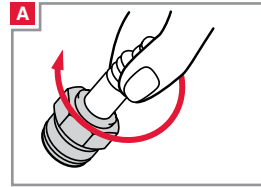

<http://www.denso-am.pl/e-katalog/>

ZALECANE MOMENTY DOKRĘCANIA					
Rozmiar gwintu	Zalecany moment	Zalecany kąt		Nowa świeca	Używana świeca
Uszczelka	M8 typ Y	8-10 Nm	± 1 obr.	± 1/12 obr.	
	M10 typ U, N	10-15 Nm	± 2/3 obr.	± 1/12 obr.	
	M10 Uszczelka ze stali nierdzewnej	10-15 Nm	± 3/4 obr.	± 1/12 obr.	
	M12 typ SXU, X, XE, XU, ZXE, Z XU	15-20 Nm	± 1/3 obr.	± 1/12 obr.	
	M14 typ FK, J, K, KJ, P, PK, PKJ, PQ, Q, QJ, QL, S, SF, SK, SKJ, SV, SVK, VK, VKJ, W, ZT	20-25 Nm	± 1/2 obr.	± 1/12 obr.	
	M14 Uszczelka ze stali nierdzewnej	20-25 Nm	± 2/3 obr.	± 1/12 obr.	
	M18 typ L, M, MA, MW	30-40 Nm	± 1/4 obr.	± 1/12 obr.	
Uszczelnienie stożkowe	M14 typ PT, PTJ, T	20-30 Nm	± 1/16 obr.	± 1/16 obr.	
	M18 typ MA	30-40 Nm	± 1/4 obr.	± 1/12 obr.	



Jeśli gwint pokryty jest środkiem smarnym, przestrzeganie zalecanego momentu dokręcania oznacza nadmierne dokręcenie; prowadzi to do nieszczelności uszczelki. Nie wolno używać środka smarnego do gwintów.

Przekroczenie kątów lub momentów dokręcania podanych w powyższej tabeli może spowodować uszkodzenie silnika a dodatkowo do przekręcenia gwintu świecy.

PL

Charakterystyka świecy zapłonowej

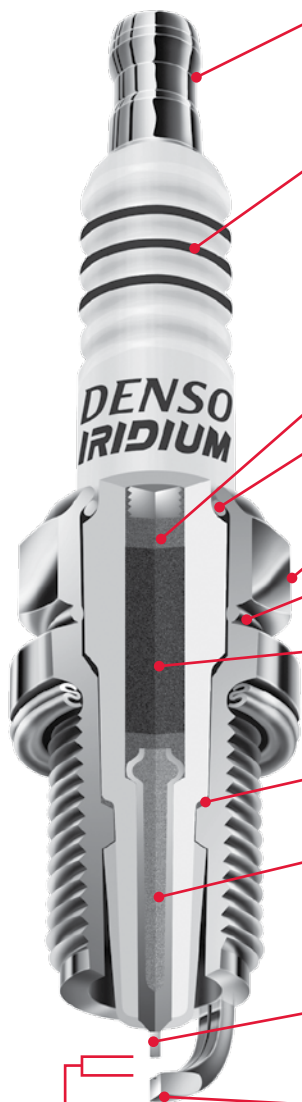

Zacisk

- > Gwintowany, zdejmowany, fałdowany bądź lity

Izolator ceramiczny

- > Konstrukcja pięcioletrowa
- > Zmniejsza spadek napięcia i zapobiega stratom iskry
- > Stosowany tlenek glinu o wysokiej czystości
- > Dobre własności dielektryczne, trwałość i przewodność cieplna
- > Stabilny chemicznie

Pierścień

Specjalne uszczelnienie miedziano-szklane

- > Dobra szczelność, trwałość i przewodność cieplna.

Korpus

- > Powłoka niklowa o wysokiej odporności na korozję

Uszczelka termiczna

- > Odporna termicznie, zapewnia dobrą szczelność i niewielkie zmiany wartości cieplnej.

Rezystor

- > Dzięki rezystancji 5 k Ω zapewnia obniżony poziom szumów radiowych.

Uszczelnienie

Elektroda środkowa z rdzeniem miedzianym

- > W porównaniu do innych producentów, DENSO wykorzystuje wyższe stężenie miedzi, aby uzyskać lepsze właściwości termiczne
- > Mocna stabilna iskra w całym zakresie obrotów.

Elektroda środkowa

- > Świece irydowe firmy DENSO mają elektrodę środkową o najmniejszej średnicy na świecy - 0,4 mm

Elektroda masy

- > Dostępna z rowkiem o profilu U, który zapewnia wyższą sprawność spalania
- > Stabilne spalanie dzięki ścięciu stożkowemu.
- > Dostępna z platynową końcówką dla długiej żywotności
- > Dostępna z końcówką platynową igłową dla długiej żywotności i najlepszej zapłonności

Odstęp pomiędzy elektrodami



- > Większość świec zapłonowych DENSO ma odpowiednio ustawiony odstęp między elektrodami, dzięki czemu nie ma potrzeby samodzielnego ustawiania odstępu

Świece irydowe/ platynowe / niklowe

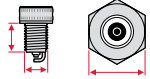

ŚWIECE ZAPŁONOWE DENSO																																																														
	W	16	E	XR	-U	11																																																								
	K	20		PR	-A	11																																																								
	XU	22	H	CR	-11S																																																									
Rodzaj metalu szlachetnego	Średnica gwintu oraz rozwartość klucza	Wartość cieplna	Długość	Kształt (Typ)	Kształt (Typ)	Odstęp pomiędzy elektrodami																																																								
<p>D ... elektroda środkowa irydowa o średnicy 0.7 mm; elektroda masowa z igłą platynową (SIP)</p> <p>F ... elektroda środkowa irydowa o średnicy 0.55 mm; elektroda masowa z igłą platynową (SIP) o średnicy 0.7 mm</p> <p>P ... elektroda środkowa platynowa o średnicy 1.1 mm; elektroda masowa z końcówką platynową</p> <p>S ... elektroda środkowa irydowa o średnicy 0.7 mm; elektroda masowa z końcówką platynową</p> <p>SV ... elektroda środkowa irydowa o średnicy 0.4 mm; elektroda masowa z końcówką platynową</p> <p>Z ... elektroda środkowa irydowa o średnicy 0.55 mm; elektroda masowa z końcówką platynową</p>	<p>C 12x14.0</p> <p>L 18x22.2 (Długość: 12.7 mm)</p> <p>M 18x25.4 (Długość: 12 mm)</p> <p>MA 18x20.6 (Gniazdo stożkowe, długość: 12 mm)</p> <p>MW 18x20.6 (Długość: 12 mm)</p> <p>J 14x20.6 (Świeca z wysuniętym punktem iskrzenia)</p> <p>K 14x16.0 (Świeca miniaturowa)</p> <p>KJ 14x16.0 (Świeca miniaturowa z wysuniętym punktem iskrzenia)</p> <p>LP 14x20.6 (Świeca do zastosowań LPG)</p> <p>Q 14x16.0 (Świeca miniaturowa)</p> <p>QJ 14x16.0 (Świeca miniaturowa z wysuniętym punktem iskrzenia)</p> <p>QL 14x20.6 (Miniaturowa świeca do długiej budowy cylindra)</p> <p>S 14x20.6 (Świeca z przerwą powierzchniową (do silników RE))</p> <p>T 14x16.0 (Gniazdo stożkowe)</p> <p>W 14x20.6 (Typ kompaktowy)</p> <p>X 12x18.0</p> <p>XE 12x14.0</p> <p>XU 12x16.0</p> <p>N 10x16.0</p> <p>U 10x16.0</p> <p>Y 8x13.0</p>	<table border="1"> <thead> <tr> <th>DENSO</th> <th>NGK</th> <th>CHAMPION</th> <th>BOSCH</th> </tr> </thead> <tbody> <tr> <td>4</td> <td></td> <td></td> <td></td> </tr> <tr> <td>9</td> <td>2</td> <td>18</td> <td>10</td> </tr> <tr> <td>14</td> <td>4</td> <td>16,14</td> <td>9</td> </tr> <tr> <td>16</td> <td>5</td> <td>12,11</td> <td>8</td> </tr> <tr> <td>20</td> <td>6</td> <td>10,9</td> <td>7,6</td> </tr> <tr> <td>22</td> <td>7</td> <td>8,7</td> <td>5</td> </tr> <tr> <td>24</td> <td>8</td> <td>6,63,61</td> <td>4</td> </tr> <tr> <td>27</td> <td>9</td> <td>4,59</td> <td>3</td> </tr> <tr> <td>29</td> <td>9.5</td> <td>57</td> <td></td> </tr> <tr> <td>31</td> <td>10</td> <td>55</td> <td>2</td> </tr> <tr> <td>32</td> <td>10.5</td> <td>53</td> <td></td> </tr> <tr> <td>34</td> <td>11</td> <td></td> <td></td> </tr> <tr> <td>35</td> <td>11.5</td> <td></td> <td></td> </tr> </tbody> </table>	DENSO	NGK	CHAMPION	BOSCH	4				9	2	18	10	14	4	16,14	9	16	5	12,11	8	20	6	10,9	7,6	22	7	8,7	5	24	8	6,63,61	4	27	9	4,59	3	29	9.5	57		31	10	55	2	32	10.5	53		34	11			35	11.5			<p>A 19.0 mm (Położenie iskry: 7.0 mm) J16AR-U11</p> <p>A 21.5 mm S29A</p> <p>B 19.0 mm (Położenie iskry: 9.5 mm) J16BR-U</p> <p>C 19.0 mm (Położenie iskry: 5.0 mm) KJ20CR-L11</p> <p>D 19.0 mm (Osłona 2) K20DTR-S11</p> <p>E (Z uszczelką) 19.0 mm W16EX-U</p> <p>E (Z uszczelką) 20.0 mm W25EBR</p> <p>E (Gniazdo stożkowe) 19.0 mm T16EPR-U</p> <p>F 12.7 mm W20FP-U</p> <p>FE 19.0 mm (Gwint do połowy) U24FER9</p> <p>G 19.0 mm (Osłona 3.5) PK20GR8</p> <p>G 19.0 mm (Osłona 3) X27GPR-U</p> <p>H ... 26.5 mm QJ16HR-U</p> <p>H 19.0 mm (Położenie iskry: 8.5 mm) K16HPR-U11</p> <p>L 11.2 mm W14L</p> <p>N (Gniazdo stożkowe, gwint do połowy) 17.5 mm T20NR-U11</p> <p>V (Gniazdo stożkowe) 25.0 mm PT16VR13</p> <p>Brak 9.5 mm W14M-U 11.2 mm L14-U, M24S 19.0 mm SK20R11 21.5 mm S29A</p> <p>Brak (Gniazdo stożkowe) 8.3 mm T20M-U 11.2 mm T16PR-U</p>	<p>A ... Dwie elektrody masowe W22EA</p> <p>AY ... Dwie elektrody masowe - wygięte J16AY</p> <p>B ... Trzy elektrody masowe W22EB</p> <p>BG ... Trzy elektrody masowe (z osłoną) SK20BGR11</p> <p>C ... Osłona 1.5 mm SXU22HCR11</p> <p>D ... 4 elektrody masy W27EDR</p> <p>D ... Wysunięte (wysunięcie 1.5 mm, położenie iskry 3.5 mm) XU22HDR9</p> <p>E ... Osłona 2.0 mm FXE20HE11</p> <p>K ... Wysunięcie izolatora 1 mm W16EKR-S11</p> <p>LM ... Typ kompaktowy (Rozwartość klucza 20.6 mm) W14LM-U</p> <p>M ... Krótsza długość gwintu izolatora W27EMR-C</p> <p>M ... Typ kompaktowy (Rozwartość klucza 19.0 mm) W20M-U</p> <p>P ... Wysunięte (wysunięcie 1.5 mm) W16EP-U</p> <p>Q ... Wysunięte 2 mm, położenie iskry 3.5 mm</p> <p>R ... Rezystor 5k ohm K16R-U</p> <p>S ... Niewysunięte (wysunięte 0 mm) W22ES-U</p> <p>S ... Irydowe z jednej strony KJ20SR11</p> <p>T ... Dwie elektrody masowe K16TR11</p> <p>TM ... Dwie elektrody masowe K22TMR11</p> <p>TN ... Dwie elektrody masowe K22TNR-S</p> <p>X ... W pełni wysunięte (wysunięte 2.5 mm) W16EX-U</p>	<p>-A ... Specjalna specyfikacja SK16PR-A11</p> <p>-B ... Specjalna specyfikacja K16PSR-B8</p> <p>-C ... Skrócone elektrody masowe W27EMR-C</p> <p>-D ... Elektroda masowa z miedzianym rdzeniem DK20PR-D13</p> <p>-E ... Specjalna specyfikacja SK16PR-E11</p> <p>-F ... Specjalna specyfikacja SK16PR-F11</p> <p>-G ... Smar na gwincie dla CNG SK20R8-G</p> <p>-GL ... Platynowa elektroda środkowa X22EPR-GL</p> <p>-L ... Żaroodporna elektroda masy K20PR-L11</p> <p>-L ... Izolator wysunięty 3.5 mm (do motocykli) W20FP-UL</p> <p>-L ... Izolator cofnięty, (do motocykli) W20FR-L</p> <p>-M ... Większa elektroda masowa SK20PR-M11S</p> <p>-N ... Do marek Yamaha i Kawasaki U27ESR-N</p> <p>-P ... Podwójna warstwa platyny na elektrodzie masowej SK20R-P11</p> <p>-P ... Świeca platynowa - pojedyncza platyna K16PR-P11</p> <p>-R ... Opornik 10K ohm K22PR-UR</p> <p>-S ... Szczelina Semi-Surface W20EP-S11</p> <p>-S ... Uszczelka ze stali nierdzewnej U27FER9S</p> <p>-T ... Dla LPG SK20HR8-T</p> <p>-T ... Specjalna specyfikacja FK20HBR11-T</p> <p>-TP ... Platynowa elektroda środkowa, Stożkowa elektroda środkowa K20PR-TP11</p> <p>-U ... Elektroda masowa z rowkiem w kształcie U K16PR-U</p> <p>-US ... Gwiazdzista elektroda środkowa W20M-US</p> <p>-V ... Średnica 1.3mm, niklowa elektroda środkowa W27ES-V</p>	<p>5 0.5 mm (.020")</p> <p>8 0.8 mm (.032")</p> <p>9 0.9 mm (.035")</p> <p>10 1.0 mm (.040")</p> <p>11 1.1 mm (.044")</p> <p>13 1.3 mm (.050")</p> <p>14 1.4 mm (.055")</p> <p>15 1.5 mm (.060")</p> <p><Brak></p> <p>Samochody: 0.8 mm</p> <p>Motocykle: 0.7 mm</p> <p><Wyjątki>: P16R, PQ16R, PQ20R: 1.1 mm</p>
DENSO	NGK	CHAMPION	BOSCH																																																											
4																																																														
9	2	18	10																																																											
14	4	16,14	9																																																											
16	5	12,11	8																																																											
20	6	10,9	7,6																																																											
22	7	8,7	5																																																											
24	8	6,63,61	4																																																											
27	9	4,59	3																																																											
29	9.5	57																																																												
31	10	55	2																																																											
32	10.5	53																																																												
34	11																																																													
35	11.5																																																													

PL

IRIDIUM POWER® Typoszeregi świec irydowych (Power, Tough)

ŚWIECE ZAPŁONOWE DENSO																																															
I	U	27	A																																												
VF	KH	20																																													
																																															
Świeca dużej wydajności	Średnica gwintu, długość i rozwarłość klucza	Wartość cieplna		Kształt (typ)																																											
I Irydowa elektroda środkowa o średnicy 0.4 mm V Irydowa elektroda środkowa o średnicy 0.4 mm z końcówką platynową VF ... Irydowa elektroda środkowa o średnicy 0.4 mm, elektroda masowa z igłą platynową (SIP)	<Średnica gwintu x długość x rozwarłość klucza (mm)> CH ... 12x26.5x14.0 K 14x19.0x16.0 KA ... 14x19.0 (Nowa potrójna elektroda w osłonie)x16.0 KB ... 14x19.0 (Nowe potrójne elektrody)x16.0 KBH 14x26.5 (Nowe potrójne elektrody)x16.0 KD ... 14x19.0 (W osłonie)x16.0 KH ... 14x26.5x16.0 NH ... 10x19.0 (Gwint do połowy)x16.0 T 14x17.5 (Gniazdo stożkowe)x16.0 TF ... 14x11.2 (Gniazdo stożkowe)x16.0 TL ... 14x25.0 (Gniazdo stożkowe, długi izolator)x16.0 TV ... 14x25.0 (Gniazdo stożkowe)x16.0 Q 14x19.0x16.0 U 10x19.0x16.0 UF ... 10x12.7x16.0 UH ... 10x19.0 (Gwint do połowy)x16.0 W 14x19.0x20.6 WF ... 14x12.7x20.6 WM ... 14x19.0x20.6 (Kompaktowy izolator) X 12x19.0x18.0 XEH 12x26.5 (Osłona 2.0)x14.0 XG ... 12x19.0 (Osłona 3.0)x18.0 XU ... 12x19.0x16.0 XUH 12x26.5x16.0 Y 8x19.0 (Gwint do połowy)x13.0	<table border="1"> <thead> <tr> <th>DENSO</th> <th>NGK</th> <th>CHAMPION</th> <th>BOSCH</th> </tr> </thead> <tbody> <tr> <td>16</td> <td>5</td> <td>12,11</td> <td>8</td> </tr> <tr> <td>20</td> <td>6</td> <td>10,9</td> <td>7,6</td> </tr> <tr> <td>22</td> <td>7</td> <td>8,7</td> <td>5</td> </tr> <tr> <td>24</td> <td>8</td> <td>6,63,61</td> <td>4</td> </tr> <tr> <td>27</td> <td>9</td> <td>4,59</td> <td>3</td> </tr> <tr> <td>29</td> <td>9.5</td> <td>57</td> <td></td> </tr> <tr> <td>31</td> <td>10</td> <td>55</td> <td>2</td> </tr> <tr> <td>32</td> <td>10.5</td> <td>53</td> <td></td> </tr> <tr> <td>34</td> <td>11</td> <td></td> <td></td> </tr> <tr> <td>35</td> <td>11.5</td> <td></td> <td></td> </tr> </tbody> </table>	DENSO	NGK	CHAMPION	BOSCH	16	5	12,11	8	20	6	10,9	7,6	22	7	8,7	5	24	8	6,63,61	4	27	9	4,59	3	29	9.5	57		31	10	55	2	32	10.5	53		34	11			35	11.5			A Elektroda pochyla, brak rowka w kształcie U, brak ścięcia na elektrodzie masowej B Wysunięty izolator (1.5 mm) C Brak rowka w kształcie U D Brak rowka w kształcie U, elektroda masowa z inconelu E Osłona: 2 mm ES ... Uszczelka ze stali nierdzewnej F Specjalna specyfikacja G Uszczelka ze stali nierdzewnej I Położenie iskry: 4 mm J Położenie iskry: 5 mm K Położenie iskry: 4 mm L Położenie iskry: 5 mm T Do zastosowań LPG Y Odstęp pomiędzy elektrodami 0.8 mm Z Ścięcie stożkowe
DENSO	NGK	CHAMPION	BOSCH																																												
16	5	12,11	8																																												
20	6	10,9	7,6																																												
22	7	8,7	5																																												
24	8	6,63,61	4																																												
27	9	4,59	3																																												
29	9.5	57																																													
31	10	55	2																																												
32	10.5	53																																													
34	11																																														
35	11.5																																														

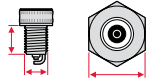
TT

ŚWIECE ZAPŁONOWE DENSO																			
I	W	16	TT																
	XEH	20	ETT																
																			
Rodzaj metalu szlachetnego	Średnica gwintu, długość i rozwarłość klucza	Wartość cieplna		Kształt (typ)															
I Irydowa elektroda środkowa o średnicy 0.4 mm, elektroda masowa z igłą platynową o średnicy 0.7 mm	<Średnica gwintu x długość x rozwarłość klucza (mm)> K 14x19.0x16.0 KBH 14x26.5 (Nowa potrójna elektroda)x16.0 KH ... 14x26.5x16.0 Q 14x19.0x16.0 T 14x17.5 (Gniazdo stożkowe)x16.0 TF ... 14x11.2 (Gniazdo stożkowe)x16.0 TL ... 14x25.0 (Gniazdo stożkowe, długi izolator)x16.0 TV ... 14x25.0 (Gniazdo stożkowe)x16.0 W 14x19.0x20.6 WF ... 14x12.7x20.6 XEH 12x26.5 (Osłona 2.0)x14.0 XU ... 12x19.0x16.0 XUH 12x26.5x16.0	<table border="1"> <thead> <tr> <th>DENSO</th> <th>NGK</th> <th>CHAMPION</th> <th>BOSCH</th> </tr> </thead> <tbody> <tr> <td>16</td> <td>5</td> <td>12,11</td> <td>8</td> </tr> <tr> <td>20</td> <td>6</td> <td>10,9</td> <td>7,6</td> </tr> <tr> <td>22</td> <td>7</td> <td>8,7</td> <td>5</td> </tr> </tbody> </table>	DENSO	NGK	CHAMPION	BOSCH	16	5	12,11	8	20	6	10,9	7,6	22	7	8,7	5	E Osłona: 2 mm IXEH20ETT TT ... Niklowa świeca TT (średnica elektrody środkowej 0.15 mm, średnica elektrody masowej 0.15 mm) W16TT TT ... Irydowa świeca TT (średnica elektrody środkowej 0.4 mm, średnica elektrody masowej 0.7 mm) IW16TT I Położenie iskry: 4 mm Wysunięty izolator (1.5 mm) XUH20TTI
DENSO	NGK	CHAMPION	BOSCH																
16	5	12,11	8																
20	6	10,9	7,6																
22	7	8,7	5																

Oferta świec żarowych

Program świec żarowych DENSO najwyższej jakości OE, przeznaczonych dla wszystkich marek, wprowadzono w celu zapewnienia klientom rynku wtórnego alternatywnego, zaawansowanego, markowego rozwiązania zaspokajającego potrzeby rosnącej liczby użytkowników pojazdów z silnikami diesla.

Najnowocześniejszy program czerpie z dorobku DENSO Corporation – jednego z wiodących światowych producentów OE świec żarowych dla czołowych dostawców przemysłu motoryzacyjnego na świecie. Nasz program świec żarowych dla rynku wtórnego, zaprojektowany zgodnie ze standardami OE, obejmuje 138 numerów katalogowych, które pokrywają 4800 zastosowań, co stanowi 98% parku samochodowego w Europie. Planujemy stałe rozszerzanie oferty celem jej wzbogacenia i uaktualnienia.

Program świec żarowych DENSO obejmuje wszystkie współczesne technologie świec żarowych, w tym świece z jedną spiralą grzejną, z dwoma spiralami grzejnymi, z wydłużonym dogrzewaniem, ceramiczne świece żarowe oraz świece żarowe szybkiego grzania.

Cechy świec żarowych DENSO:

- > Świece żarowe jakości OE, które spełniają lub przekraczają specyfikacje producentów
- > Krótsze czasy grzania wstępnego i niezawodny zimny rozruch
- > Wydłużone dogrzewanie w celu zapewnienia niższej emisji
- > Doskonałe pokrycie gwarantuje kompatybilność z prawie wszystkimi silnikami diesla w Europie
- > Pokrycie większej liczby zastosowań mniejszą liczbą pozycji katalogowych
- > Łatwy w użyciu system numeracji części
- > Zgodność z normami ISO TS16949, ISO14001 i OHSAS 18001

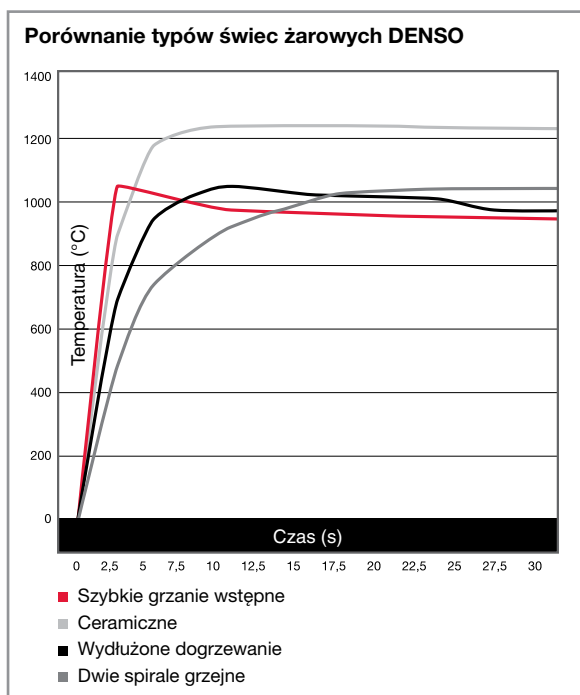

Sposób montażu świecy żarowej

Zalecane momenty dokręcania dla świec żarowych DENSO:

1. Używać prawidłowego klucza do świecy żarowej i złącza.
2. Przy wymianie świec żarowych upewnić się, że olej, brud itd. znajdujący się na zewnątrz wymontowanej świecy żarowej nie dostał się do cylindra.
3. Podczas montażu świecy żarowej oczyścić kołnierz od strony silnika i upewnić się, że świeca żarowa jest ustawiona w osi gwintowanego gniazda głowicy silnika.
4. Upewnić się, że świeca jest ustawiona prawidłowo i dokręcić palcami do oporu.
5. Następnie za pomocą klucza dynamometrycznego dokręcić dokładnie momentem podanym w poniższej tabeli.

ZALECANE MOMENTY DOKRĘCANIA		
	Rozmiar gwintu	Zalecany moment dokręcania
Świeca żarowa	M8x1.00	8-10 Nm
	M9x1.00	8-10 Nm
	M10x1.00	10-12 Nm
	M10x1.25	10-12 Nm
	M12x1.25	15-20 Nm
	M14x1.25	20-25 Nm
Złącze	M18x1.50	30-40 Nm
	M4x0.7	1-1.5 Nm
	M5x0.8	3-4 Nm



NIE UŻYWAĆ ŚRODKA SMARNEGO DO GWINTÓW!
Jeśli gwint pokryty jest środkiem smarnym do gwintów, tarcie między świecą a głowicą silnika będzie mniejsze > powodując przekręcenie gwintu.



Dokręcenie momentem wyższym od podanego w tabeli może doprowadzić do uszkodzenia świecy żarowej i silnika.



Najczęstszą przyczyną awarii świec żarowych jest zbyt wysokie napięcie lub temperatura. Świece żarowe przeznaczone są do działania w temperaturze od 850 do 1100 stopni.

Jeśli, z powodu usterki przełącznika lub sterownika, prąd płynie przez świecę żarową zbyt długo, może to doprowadzić do przegrzania, które powoduje puchnięcie, pęknięcie lub rozerwanie i natychmiastową awarię. W związku z tym, przed wymianą świec żarowych na nowe, zaleca się sprawdzenie całego układu elektrycznego.

Zbyt duży kąt wyprzedzenia wtrysku, nieszczelne wtryskiwacze lub benzyna w silniku mogą doprowadzić do nadmiernego wzrostu temperatury spalania, powodującego uszkodzenie świec żarowych.

PL

Schemat doskonałej technologii świec żarowych

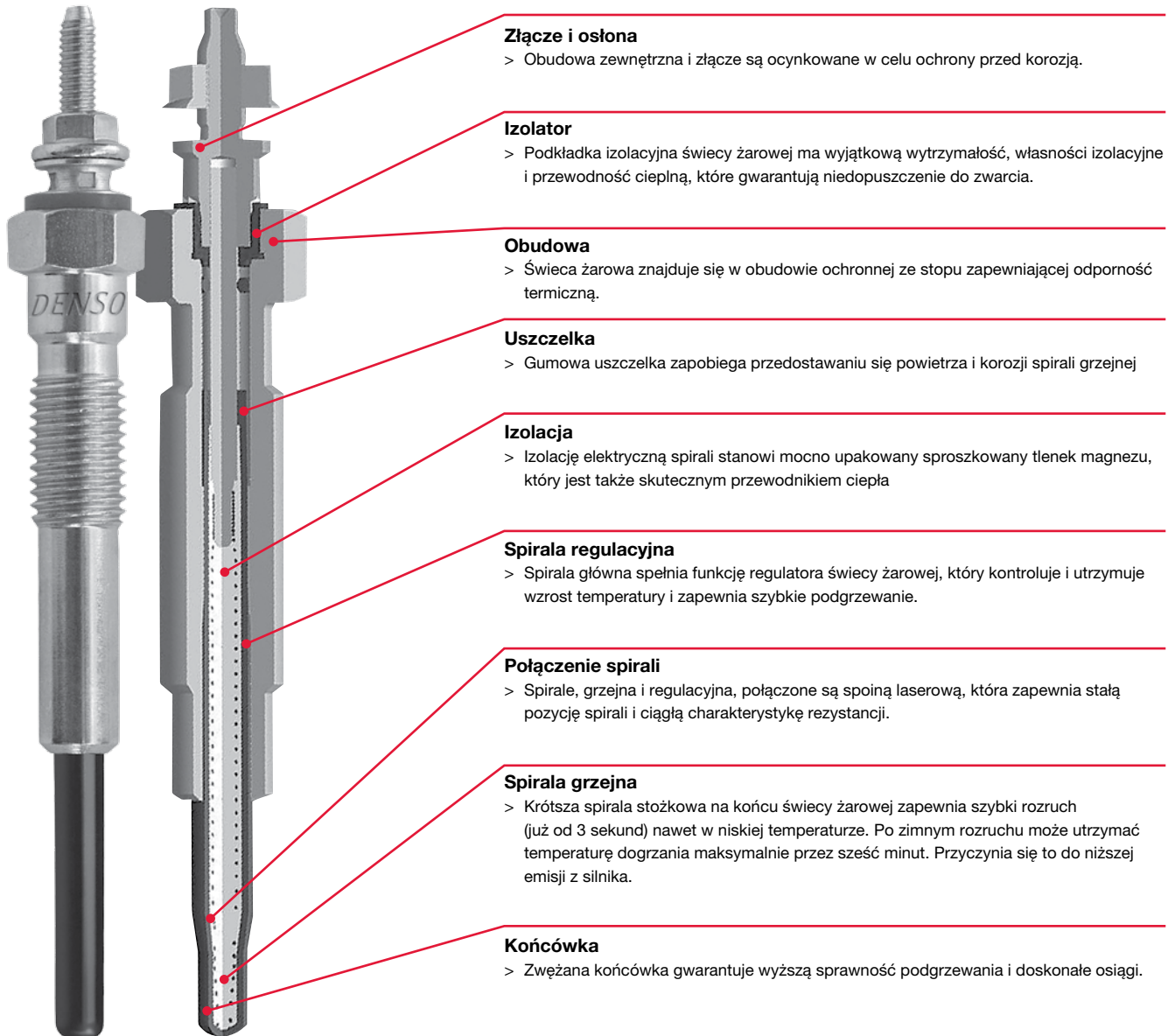

Преимущества DENSO

DENSO устанавливает стандарты в технологии производства свечей зажигания с 1959 года. Мы сами разрабатываем все типы свечей и производим их на собственных заводах, сертифицированных по QS 9000 и ISO 9000, и нашим стандартом является «ноль дефектов». Мы обеспечиваем высочайшие эксплуатационные характеристики и для рынка автозапчастей. Свечи зажигания DENSO: стандартные, платиновые, иридиевые и ТТ – покрывают весь постоянно расширяющийся диапазон применения. Чтобы обеспечить оптимальные рабочие характеристики двигателя, выбирайте свечи зажигания DENSO для любых автомобилей, мотоциклов, водного транспорта и малых моторов.

Ассортимент

Свечи с улучшенными характеристиками

Nickel TT

- > Центральный и боковой электрод с выступом из никелевого сплава
- > Низкая токсичность выхлопных газов
- > Экономия топлива
- > Ровная работа двигателя даже в экстремальных ситуациях
- > Наилучшее соотношение цена/качество среди свечей зажигания

Iridium TT

- > Улучшенный, более надежный запуск
- > Характеристики зажигания (стабильность искры, стойкость к воздействию низких температур), улучшенные на 20 % по сравнению со стандартными иридиевыми свечами
- > Межсервисный пробег — до 120 000 км
- > Премиум-технология, доступная теперь для более широкого модельного ряда
- > Экономичность — снижение расхода топлива в крейсерских режимах

Информация в настоящем каталоге действительна на дату выпуска. Пожалуйста, обратитесь к нашему электронному каталогу для получения более актуальной информации.

Рекомендации в настоящем каталоге основаны на последней информации от производителей для работы в стандартных условиях. Мы не принимаем правовые претензии, возникающие из содержания настоящего списка.

Информация по перекрестным ссылкам должна использоваться только для справки. Различия в конструкции и материалах между производителями могут варьироваться в тепловом диапазоне. Смотрите раздел рекомендации для конкретных применений двигателя.

Если указываются имена и/или номера производителей, то они даются только для справочных целей и не указывают на источник производства или какую-либо торговую связь с упомянутыми производителями. Для того, чтобы найти правильную свечу зажигания, пожалуйста, обратитесь к оригинальному номеру детали (OEM) на детали и найдите соответствующий номер детали DENSO в таблице перекрестных ссылок.

Свечи, идентичные оригинальным

Nickel

- > Медно-стеклянное уплотнение обеспечивает рассеивание тепла
- > Стандартный U-образный паз
- > Глубоко вставленный медный сердечник
- > Теплостойкое никелевое покрытие
- > В ассортименте есть свечи с несколькими боковыми электродами

Double Platinum (Longlife)

- > Улучшенный, более надежный запуск
- > Более полное сгорание (уменьшение выбросов)
- > Лучшая способность преодолевать неточности настройки
- > Великолепные приемистость и ускорение
- > Технология, испытанная в гонках

Iridium Power

- > Великолепная воспламеняемость
- > Низкое требуемое напряжение
- > Лучше динамика и стабильность работы
- > Меньший расход топлива

Iridium Longlife, Iridium Tough

- > Великолепная воспламеняемость
- > Низкое требуемое напряжение
- > Лучше динамика и стабильность работы
- > Меньший расход топлива
- > Более продолжительный срок службы

Super Ignition Plug (SIP)

- > Два супертонких долговечных электрода – центральный и боковой
- > Новейшая технология свечей зажигания
- > Используются как OE в автомобилях Honda, Hyundai, Kia, Lexus, Nissan, Mitsubishi, Mazda, Subaru, Toyota и Volvo
- > Наивысшая эффективность
- > Продолжительный срок службы

Свечи для высокофорсированных моторов

Iridium Racing

- > Технология Формулы-1
- > Максимальное ускорение
- > Высокая надежность
- > Повышенная эффективность

Ассортимент	Свечи ТТ		Идентичные оригинальным							Racing
Материал	Nickel	Iridium	Nickel	Platinum	Iridium					Iridium
Тип	Nickel ТТ	Iridium ТТ	Nickel	Platinum	Iridium OEM ⁵	Iridium Long life ⁵	Iridium Power	Iridium Tough	SIP	Iridium Racing
U-образный паз	-	-	+ ¹	-	-	-	+ ²	-	-	-
Конический боковой электрод	-	Некоторые типы	Некоторые типы ³	-	-	-	+ ²	-	Некоторые типы	-
Материал бокового электрода	Никелевый сплав	Платиновый 0.7 мм ⁶	Обычный	Платиновая накладка	Платиновая накладка	Платиновая накладка	Обычный	Платиновая накладка ⁷	Платиновый 0.7 мм ⁶	Полностью платиновый
Центральный электрод	1.5 мм	0.55 мм	2.5 мм	1.1 мм	0.7 мм	0.4 мм	0.4 мм	0.4 мм	0.55 мм	0.4 мм ⁴
Доступные калильные числа	16-20	20-24	9-27	16-22	16-22	16-27	16-34	16-24	20-24	24-35
Резистор	Все типы	Все типы	Большинство типов	Все типы	Все типы	Все типы	Все типы	Все типы	Все типы	Все типы
Высокий КПД	+++	+++++	+	++	++++	++++	++++	++++	+++++	+++++
Экономия топлива	Лучше	Наилучшая	Хорошая	Лучше	Наилучшая	Наилучшая	Наилучшая	Наилучшая	Наилучшая	-
Долговечность	Обычная	Долговечная	Обычная	Долговечная	Долговечная	Долговечная	Обычная	Долговечная	Долговечная	Только для гонок

¹ Типы свечей зажигания без U в наименовании типа не имеют U-образного паза

² Не применяются для IU24A, IU27A, IU31A, IUF27A и IUF31A

³ Типы свечей зажигания с Z в наименовании имеют заземляющий электрод конической формы

⁴ За исключением типов с поверхностным зазором

⁵ Типы OEM, только для некоторых машин

⁶ Needle Platinum 0.7 мм

⁷ Needle Platinum 0.7 мм available

Установка свечи зажигания

Рекомендуемые момент и угол затяжки для свечей DENSO.

1. Используйте гаечный ключ, соответствующий шестиграннику свечи, и будьте осторожны, чтобы не повредить изолятор.
2. При замене свечей следите за тем, чтобы масло и прочие загрязнения на наружной части свечи не попали внутрь двигателя.
3. При установке свечей очистите сторону фланца двигателя и устанавливайте свечи зажигания, убедившись в наличии прокладки на ее фланце.
4. Убедитесь в том, что свечи зажигания расположены вертикально, и затяните их усилием руки до тех пор, пока их более завернуть нельзя (A+B).
5. Затем используйте динамометрический ключ для затягивания свечи моментом, точно соответствующим величине, указанной в таблице. Если динамометрический ключ отсутствует, используйте свечной ключ и рекомендации по затяжке свечи на угол, указанный в таблице. Подробная информация о моментах затяжки для разных типов свечей приведена в нашем электронном каталоге (C+D).

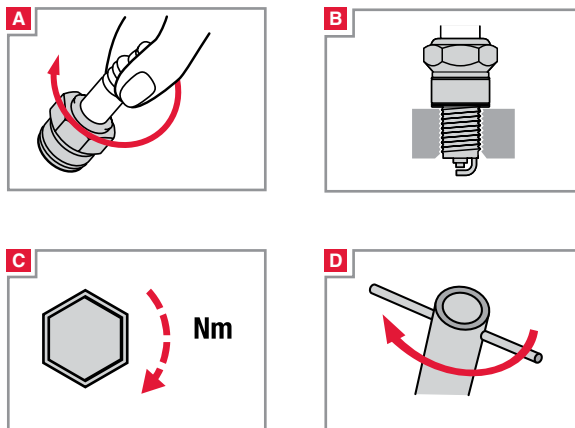

<http://www.denso-am.ru/elektronnyi-katalog/>

РЕКОМЕНДУЕМЫЕ ВЕЛИЧИНЫ МОМЕНТОВ ЗАТЯЖКИ ПРИ УСТАНОВКЕ

Размер резьбы	Рекомендуемый момент	Рекомендуемое число оборотов		
		Новая свеча зажигания	Использ. свеча зажигания	
Прокладка	M8 Тип Y	8-10 Нм	± 1 обор.	± 1/12 обор.
	M10 Тип U, N	10-15 Нм	± 2/3 обор.	± 1/12 обор.
	M10 Прокладка из нержавеющей стали	10-15 Нм	± 3/4 обор.	± 1/12 обор.
	M12 Тип SXU, X, XE, XU, ZXE, Z XU	15-20 Нм	± 1/3 обор.	± 1/12 обор.
	M14 Тип FK, J, K, KJ, P, PK, PKJ, PQ, Q, QJ, QL, S, SF, SK, SKJ, SV, SVK, VK, VKJ, W, ZT	20-25 Нм	± 1/2 обор.	± 1/12 обор.
	M14 Прокладка из нержавеющей стали	20-25 Нм	± 2/3 обор.	± 1/12 обор.
	M18 Тип L, M, MA, MW	30-40 Нм	± 1/4 обор.	± 1/12 обор.
Коническое гнездо	M14 Тип PT, PTJ, T	20-30 Нм	± 1/16 обор.	± 1/16 обор.
	M18 Тип MA	30-40 Нм	± 1/4 обор.	± 1/12 обор.



Если нити резьбы покрыты густой смазкой, то затяжка до рекомендуемого момента приведет к излишней затяжке; это связано с вытеканием смазки. Не используйте смазку для резьбы.

Затяжка моментами и углами, превосходящими те, которые показаны справа, может привести к повреждению двигателя и в дальнейшем к тому, что свеча зажигания может вырваться из резьбы.

RU

Устройство свечи зажигания

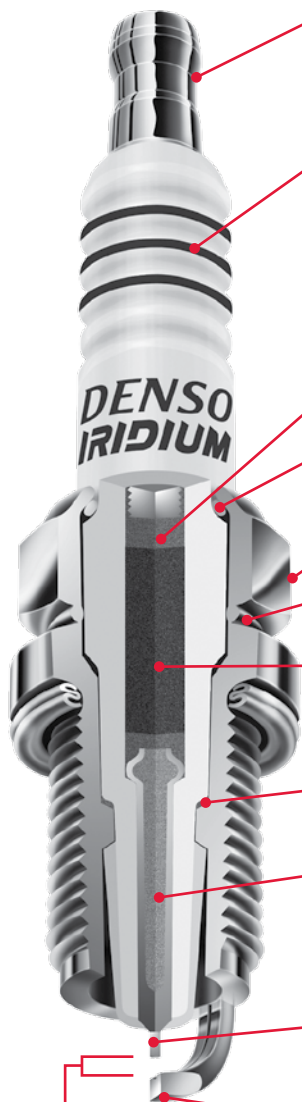

Клемма

- > С резьбой, съемный, съемная, обжатая или цельная

Керамический изолятор

- > На его поверхности имеются пять ребер
- > Это снижает потери напряжения и предотвращает пропуски искровых разрядов
- > Используется оксид алюминия высокой чистоты
- > Хорошая электрическая изоляция, долговечность и теплопроводность
- > Химическая стабильность

Специальное медно-стеклянное уплотнение

- > Хорошие газонепроницаемость, долговечность и теплопроводность

Кольцо

Корпус

- > Никелевое покрытие с высокими антикоррозийными свойствами

Запрессовка при электрическом нагреве

- > Термостойкость, хорошая герметичность и малые изменения в диапазоне нагрева

Резистор

- > Сопротивление 5 ком, снижает радиопомехи

Уплотнение

Центральный электрод с сердечником из меди

- > По сравнению с другими производителями, DENSO использует сплавы с большим содержанием меди для улучшения тепловых характеристик
- > Мощная устойчивая искра в диапазоне от малых до высоких скоростей

Центральный электрод

- > Свечи зажигания DENSO IRIDIUM имеют самый тонкий в мире центральный электрод диаметром 0,4 мм

Заземляющий электрод

- > Доступны с U-образным пазом, обеспечивающим более полное сгорание горючего
- > Конусообразная форма гарантирует стабильность зажигания
- > Доступны с платиновыми наконечниками, увеличивающими срок службы
- > Доступны с игольчатыми наконечниками, обеспечивающими более длительный срок службы и наилучшую воспламеняемость

Искровой зазор

- > Большинство свечей зажигания DENSO поставляются с отрегулированным искровым зазором, поэтому вам не нужно его регулировать самостоятельно

Иридиевые / Платиновые / Стандартные

ОБОЗНАЧЕНИЕ СВЕЧЕЙ ЗАЖИГАНИЯ DENSO																																																														
	W	16	E	XR	-U	11																																																								
S	K	20		PR	-A	11																																																								
S	XU	22	H	CR	-11S	11																																																								
Тип благородного металла	Диаметр резьбы и размер шестигранника	Калильное число	Длина резьбы	Тип электрода	Конфигурация зазора	Зазор																																																								
D ... Иридиевый центральный электрод диаметром 0.7 мм с платиновой иглой на боковом электроде (SIP) F ... Иридиевый центральный электрод диаметром 0.55 мм с платиновой иглой на боковом электроде (SIP) P ... Платиновый центральный электрод диаметром 1.1 мм с платиновой накладкой на боковом электроде S ... Иридиевый центральный электрод диаметром 0.7 мм с платиновой накладкой на боковом электроде SV ... Иридиевый центральный электрод диаметром 0.4 мм с платиновой накладкой на боковом электроде Z ... Иридиевый центральный электрод диаметром 0.55 мм с платиновой накладкой на боковом электроде	C 12x14.0 L 18x22.2 (Длина резьбы: 12.7 мм) M 18x25.4 (Длина резьбы: 12 мм) MA 18x20.6 (Коническое гнездо, длина резьбы: 12 мм) MW 18x20.6 (Длина резьбы: 12 мм) J 14x20.6 (Выступающая свеча) K 14x16.0 KJ 14x16.0 (Выступающая свеча) LP 14x20.6 (Свеча для двигателей, работающих на СПГ) Q 14x16.0 QJ 14x16.0 (Выступающая свеча) QL 14x20.6 (Длинный цилиндрический корпус) S 14x20.6 (Свеча с поверхностным зазором) T 14x16.0 (Коническое гнездо) W 14x20.6 X 12x18.0 XE 12x14.0 XU 12x16.0 N 10x16.0 U 10x16.0 Y 8x13.0	<table border="1"> <tr> <th>DENSO</th> <th>NGK</th> <th>CHAMPION</th> <th>BOSCH</th> </tr> <tr> <td>4</td> <td></td> <td></td> <td></td> </tr> <tr> <td>9</td> <td>2</td> <td>18</td> <td>10</td> </tr> <tr> <td>14</td> <td>4</td> <td>16,14</td> <td>9</td> </tr> <tr> <td>16</td> <td>5</td> <td>12,11</td> <td>8</td> </tr> <tr> <td>20</td> <td>6</td> <td>10,9</td> <td>7,6</td> </tr> <tr> <td>22</td> <td>7</td> <td>8,7</td> <td>5</td> </tr> <tr> <td>24</td> <td>8</td> <td>6,63,61</td> <td>4</td> </tr> <tr> <td>27</td> <td>9</td> <td>4,59</td> <td>3</td> </tr> <tr> <td>29</td> <td>9.5</td> <td>57</td> <td></td> </tr> <tr> <td>31</td> <td>10</td> <td>55</td> <td>2</td> </tr> <tr> <td>32</td> <td>10.5</td> <td>53</td> <td></td> </tr> <tr> <td>34</td> <td>11</td> <td></td> <td></td> </tr> <tr> <td>35</td> <td>11.5</td> <td></td> <td></td> </tr> </table>	DENSO	NGK	CHAMPION	BOSCH	4				9	2	18	10	14	4	16,14	9	16	5	12,11	8	20	6	10,9	7,6	22	7	8,7	5	24	8	6,63,61	4	27	9	4,59	3	29	9.5	57		31	10	55	2	32	10.5	53		34	11			35	11.5			A 19.0 mm (Выступ электродов: 7.0 mm) J16AR-U11 A 21.5 mm S29A B 19.0 mm (Выступ электродов: 9.5 mm) J16BR-U C 19.0 mm (Выступ электродов: 5.0 mm) KJ20CR-L11 D 19.0 mm (Экран 2) K20DTR-S11 E (Прокладка) ... 19.0 mm W16EX-U E (Прокладка) ... 20.0 mm W25EBR E (Коническое гнездо) ... 19.0 mm T16EPR-U F 12.7 mm W20FP-U FE 19.0 mm (Резьба на половину длины) U24FER9 G 19.0 mm (Экран 3.5) PK20GR8 G 19.0 mm (Экран 3) X27GPR-U H ... 26.5 mm QJ16HR-U H 19.0 mm (Выступ электродов: 8.5 mm) K16HPR-U11 L 11.2 mm W14L N (Коническое гнездо, резьба на половину длины) ... 17.5 mm T20NR-U11 V (Коническое гнездо) ... 25.0 mm PT16VR13 Нет 9.5 mm W14M-U 11.2 mm L14-U, M24S 19.0 mm SK20R11 21.5 mm S29A Нет (Коническое гнездо) 8.3 mm T20M-U 11.2 mm T16PR-U	A ... Двойные заземляющие электроды W22EA AY ... Двойные заземляющие электроды; наклонные J16AY B ... Тройные заземляющие электроды W22EB BG ... Тройные заземляющие электроды (экранированная) SK20BGR11 C ... Экран 1.5 mm SXU22HCR11 D ... 4 заземляющих электрода W27EDR D ... Выступающая (1.5 mm выступ, выступ электродов 3.5 mm) XU22HDR9 E ... Экран: 2.0 mm FXE20HE11 K ... Выступающая (1 mm выступ) W16EKR-S11 LM ... Компактный тип (Размер шестигранника 20.6 mm) W14LM-U M ... Укороченная головка изолятора W27EMR-C M ... Компактный тип (размер шестигранника 19.0 mm) W20M-U P ... Выступающая (1.5 mm выступ) W16EP-U Q ... Выступающая 2 mm, выступ электродов 3.5 mm R ... 5 кОм резистор K16R-U S ... Полуповерхностный зазор (0 mm выступ) W22ES-U S ... Иридий на одной стороне KJ20SR11 T ... Двойные заземляющие электроды K16TR11 TM ... Двойные заземляющие электроды K22TMR11 TN ... Двойные заземляющие электроды K22TNR-S X ... Сильно выступающая (2.5 mm выступ) W16EX-U	-A ... Специальная характеристика SK16PR-A11 -B ... Специальная характеристика K16PSR-B8 -C ... Срезанный заземляющий электрод W27EMR-C -D ... Заземляющий электрод с медным сердечником DK20PR-D13 -E ... Специальная характеристика SK16PR-E11 -F ... Специальная характеристика SK16PR-F11 -G ... Смазанная резьба (для двигателей СПГ) SK20R8-G -GL ... Платиновый центральный электрод X22EPR-GL -L ... Термостойкий заземляющий электрод K20PR-L11 -L ... 3.5 mm выступ изолятора свечи для мотоциклов W20FP-UL -L ... Заглубленный изолятор для мотоциклов W20FR-L -M ... Увеличенный заземляющий SK20PR-M11S -N ... Для Yamaha и Kawasaki U27ESR-N -P ... Двойной слой платины на заземляющем электроде SK20R-P11 -P ... Односторонняя платиновая свеча K16PR-P11 -R ... 10K ом резистор K22PR-UR -S ... Полуплоскостной зазор W20EP-S11 -S ... Прокладка из нержавеющей стали U27FER9S -T ... Для СПГ SK20HR8-T -T ... Специальная характеристика FK20HBR11-T -TP ... Платиновый центральный электрод; конический заземляющий K20PR-TP11 -U ... U-образный паз в заземляющем электроде K16PR-U -US ... Звездообразный центральный электрод W20M-US -V ... 1.3 mm диаметр, никелевый центральный электрод W27ES-V	5 0.5 mm (.020") 8 0.8 mm (.032") 9 0.9 mm (.035") 10 1.0 mm (.040") 11 1.1 mm (.044") 13 1.3 mm (.050") 14 1.4 mm (.055") 15 1.5 mm (.060") <Нет> Авто: 0.8 mm Мото: 0.7 mm <Исключения> P16R, PQ16R, PQ20R - 1.1 mm
DENSO	NGK	CHAMPION	BOSCH																																																											
4																																																														
9	2	18	10																																																											
14	4	16,14	9																																																											
16	5	12,11	8																																																											
20	6	10,9	7,6																																																											
22	7	8,7	5																																																											
24	8	6,63,61	4																																																											
27	9	4,59	3																																																											
29	9.5	57																																																												
31	10	55	2																																																											
32	10.5	53																																																												
34	11																																																													
35	11.5																																																													

Spark Plugs | Система обозначений

RU

IRIDIUM POWER® Серия Iridium Power (Power, Tough, Plus)

ОБОЗНАЧЕНИЕ СВЕЧЕЙ ЗАЖИГАНИЯ DENSO																																															
I	U	27	A																																												
VF	KH	20																																													
																																															
Высокоэффективные свечи	Диаметр, длина резьбы, размер шестигранника	Калильное число	Тип																																												
<p>I..... Иридиевый диам 0.4 мм</p> <p>V..... Иридиевый диам. 0.4 мм с платиновой накладкой</p> <p>VF.. Иридиевый диам. 0.4 мм с платиновой иглой на боковом электроде (SIP)</p>	<p>< Диаметр резьбы X длина резьбы X размер шестигранника ></p> <p>CH... 12x26.5x14.0</p> <p>K..... 14x19.0x16.0</p> <p>KA... 14x19.0 (Экранированная, новые тройные электроды)x16.0</p> <p>KB... 14x19.0 (Новые тройные электроды)x16.0</p> <p>KBH.. 14x26.5 (Новые тройные электроды)x16.0</p> <p>KD... 14x19.0 (Экранированная)x16.0</p> <p>KH... 14x26.5x16.0</p> <p>NH... 10x19.0 (Резьба на половину длины)x16.0</p> <p>T..... 14x17.5 (Коническое гнездо)x16.0</p> <p>TF... 14x11.2 (Коническое гнездо)x16.0</p> <p>TL... 14x25.0 (Коническое гнездо, длинный изолятор)x16.0</p> <p>TV... 14x25.0 (Коническое гнездо)x16.0</p> <p>Q..... 14x19.0x16.0</p> <p>U..... 10x19.0x16.0</p> <p>UF... 10x12.7x16.0</p> <p>UH... 10x19.0 (Резьба на половину длины)x16.0</p> <p>W.... 14x19.0x20.6</p> <p>WF... 14x12.7x20.6</p> <p>WM... 14x19.0x20.6 (Компактный изолятор)</p> <p>X..... 12x19.0x18.0</p> <p>XEH.. 12x26.5 (Экран 2.0)x14.0</p> <p>XG... 12x19.0 (Экран 3.0)x18.0</p> <p>XU... 12x19.0x16.0</p> <p>XUH.. 12x26.5x16.0</p> <p>Y..... 8x19.0 (Резьба на половину длины)x13.0</p>	<table border="1"> <thead> <tr> <th>DENSO</th> <th>NGK</th> <th>CHAMPION</th> <th>BOSCH</th> </tr> </thead> <tbody> <tr> <td>16</td> <td>5</td> <td>12,11</td> <td>8</td> </tr> <tr> <td>20</td> <td>6</td> <td>10,9</td> <td>7,6</td> </tr> <tr> <td>22</td> <td>7</td> <td>8,7</td> <td>5</td> </tr> <tr> <td>24</td> <td>8</td> <td>6,63,61</td> <td>4</td> </tr> <tr> <td>27</td> <td>9</td> <td>4,59</td> <td>3</td> </tr> <tr> <td>29</td> <td>9.5</td> <td>57</td> <td></td> </tr> <tr> <td>31</td> <td>10</td> <td>55</td> <td>2</td> </tr> <tr> <td>32</td> <td>10.5</td> <td>53</td> <td></td> </tr> <tr> <td>34</td> <td>11</td> <td></td> <td></td> </tr> <tr> <td>35</td> <td>11.5</td> <td></td> <td></td> </tr> </tbody> </table>	DENSO	NGK	CHAMPION	BOSCH	16	5	12,11	8	20	6	10,9	7,6	22	7	8,7	5	24	8	6,63,61	4	27	9	4,59	3	29	9.5	57		31	10	55	2	32	10.5	53		34	11			35	11.5			<p>A..... Наклонный электрод, без U-образного паза, форма не конусообразная</p> <p>B..... Изолятор, выступающий на 1.5 мм</p> <p>C..... Без U-образной выемки</p> <p>D..... Без U-образной выемки, заземляющий электрод из инконеля</p> <p>E..... Экран: 2 мм</p> <p>ES.. Прокладка из нерж. стали</p> <p>F..... Специальная характеристика</p> <p>G..... Прокладка из нерж. стали</p> <p>I..... Выступ электродов: 4 мм; Изолятор, выступающий на 1.5 мм</p> <p>J..... Выступ электродов: 5 мм</p> <p>K..... Выступ электродов: 4 мм; Изолятор, выступающий на 2.5 мм</p> <p>L..... Выступ электродов: 5 мм</p> <p>T..... Для использования в газовых двигателях</p> <p>Y..... Зазор 0.8 мм</p> <p>Z..... Конусообразная форма</p>
DENSO	NGK	CHAMPION	BOSCH																																												
16	5	12,11	8																																												
20	6	10,9	7,6																																												
22	7	8,7	5																																												
24	8	6,63,61	4																																												
27	9	4,59	3																																												
29	9.5	57																																													
31	10	55	2																																												
32	10.5	53																																													
34	11																																														
35	11.5																																														

TT

ОБОЗНАЧЕНИЕ СВЕЧЕЙ ЗАЖИГАНИЯ DENSO																			
I	W	16	TT																
	XEH	20	ETT																
																			
Тип драгоценного металла	Диаметр, длина резьбы, размер шестигранника	Калильное число	Тип																
<p>I..... Иридиевый центральный электрод диаметром 0.4 мм с платиновой иглой 0,7 мм на боковом электроде</p>	<p>< Диаметр резьбы X длина резьбы X размер шестигранника ></p> <p>K..... 14x19.0x16.0</p> <p>KBH.. 14x26.5 (новые тройные электроды)x16.0</p> <p>KH... 14x26.5x16.0</p> <p>Q..... 14x19.0x16.0</p> <p>T..... 14x17.5 (с конической посадочной поверхностью)x16.0</p> <p>TF... 14x11.2 (с конической посадочной поверхностью)x16.0</p> <p>TL... 14x25.0 (с конической посадочной поверхностью, удлиненным изолятором)x16.0</p> <p>TV... 14x25.0 (с конической посадочной поверхностью)x16.0</p> <p>W.... 14x19.0x20.6</p> <p>WF... 14x12.7x20.6</p> <p>XEH.. 12x26.5 (Shroud 2.0)x14.0</p> <p>XU... 12x19.0x16.0</p> <p>XUH.. 12x26.5x16.0</p>	<table border="1"> <thead> <tr> <th>DENSO</th> <th>NGK</th> <th>CHAMPION</th> <th>BOSCH</th> </tr> </thead> <tbody> <tr> <td>16</td> <td>5</td> <td>12,11</td> <td>8</td> </tr> <tr> <td>20</td> <td>6</td> <td>10,9</td> <td>7,6</td> </tr> <tr> <td>22</td> <td>7</td> <td>8,7</td> <td>5</td> </tr> </tbody> </table>	DENSO	NGK	CHAMPION	BOSCH	16	5	12,11	8	20	6	10,9	7,6	22	7	8,7	5	<p>E..... Экран: 2 мм IXEH20ETT</p> <p>TT... Nickel TT (центральный электрод диаметром 1.5 мм, боковой электрод диаметром 1.5 мм) W16TT</p> <p>TT... Iridium TT (центральный электрод диаметром 0.4 мм, боковой электрод диаметром 0.7 мм) IW16TT</p> <p>I..... Искровой зазор: 4 мм Выступающий изолятор (1.5 мм) XUH20TTI</p>
DENSO	NGK	CHAMPION	BOSCH																
16	5	12,11	8																
20	6	10,9	7,6																
22	7	8,7	5																

RU

Ассортимент свечей накаливания

Свечи накаливания DENSO соответствуют качеству оригинального оборудования и пригодны для использования во всех автомобилях.

Инновационность продукции обусловлена богатым опытом корпорации DENSO, являющейся одним из ведущих мировых поставщиков оригинальных свечей накаливания для производителей автомобилей во всем мире. Наш ассортимент для рынка запчастей по свечам накаливания включает в себя 138 моделей, обеспечивающих более 4800 вариантов применения, что соответствует 98% автопарка Европы. Продолжающиеся доработки призваны постоянно улучшать и обновлять ассортимент.

Программа свечей накаливания DENSO объединяет все новейшие технологии производства и включает следующие типы свечей накаливания: с одной спиралью, с двумя спиральями, с продолжительным послепусковым нагревом, керамические и мгновенного нагрева.

Преимущества свечей накаливания DENSO:

- > Свечи накаливания соответствуют качеству оригинального оборудования, что отвечает требованиям производителей или даже превышает их
- > Более быстрое время разогрева и безотказный запуск холодного двигателя
- > Повышенная температура подогрева для снижения выбросов
- > Широкая применимость гарантирует возможность установки практически на любой двигатель в Европе
- > Более широкий диапазон применения с меньшим количеством разновидностей
- > Простота системы обозначения деталей
- > Соответствует стандартам ISO TS 16949, ISO 14001 и OHSAS 18001

Сравнение типов свечей накаливания DENSO

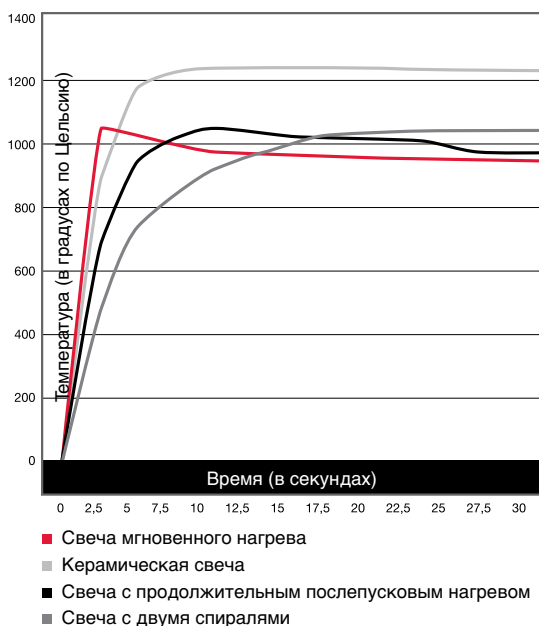

Как устанавливать свечи накаливания

Рекомендуемые технические данные затяжки свечей DENSO:

1. Используйте надлежащий ключ для свечи накаливания и клеммы.
2. При замене свечей накаливания следите за тем, чтобы при демонтаже свечи масло, загрязнения с наружной поверхности свечи и т.д. не попадали в цилиндр.
3. При монтаже свечи накаливания очистите фланец двигателя и установите свечу вровень с головкой цилиндра.
4. Убедитесь в том, что свеча установлена правильно, и закрутите ее вручную до упора.
5. После этого затяните ее ключом в точном соответствии с моментом затяжки, указанным в таблице ниже.

РЕКОМЕНДУЕМЫЕ ВЕЛИЧИНЫ МОМЕНТОВ ЗАТЯЖКИ ПРИ УСТАНОВКЕ		
	Диаметр резьбы	Рекомендуемый момент
Свечи накаливания	M8x1.00	8-10 Nm
	M9x1.00	8-10 Nm
	M10x1.00	10-12 Nm
	M10x1.25	10-12 Nm
	M12x1.25	15-20 Nm
	M14x1.25	20-25 Nm
Клемма	M4x0.7	1-1.5 Nm
	M5x0.8	3-4 Nm



НЕЛЬЗЯ СМАЗЫВАТЬ РЕЗЬБУ! При смазке резьбы трение между свечой накаливания и головкой цилиндра уменьшается; в результате возникает чрезмерная затяжка.



Затяжка с моментом, превышающим значения из вышестоящей таблицы, может привести к поломке свечи накаливания или двигателя.



Неисправность свечей накаливания чаще всего вызвана слишком высоким напряжением и/или высокой температурой. Свечи накаливания разработаны для эксплуатации в диапазоне температур от 850°C до 1100°C. В случае подачи электрического тока на свечу накаливания в течение слишком долгого времени (что может быть вызвано неисправностью блока управления или реле накаливания) может произойти перегревание свечи, которое приведет к увеличению ее размера, расслоению или разрушению и в итоге к выходу свечи из строя. В связи с этим рекомендуется проверить все электрооборудование перед заменой свечей накаливания. Ранний момент впрыска, неправильная установка инжектора или прямое попадание топлива в камеру сгорания двигателя вызывают чрезмерное увеличение температуры сгорания, что также приводит к повреждению свечей накаливания. **Неисправное реле или контроллер также могут вызвать повреждение свечей накаливания,** поэтому рекомендуется проверять всю систему впрыска перед заменой свечей накаливания на новые.

RU

Конструкция свечи накаливания

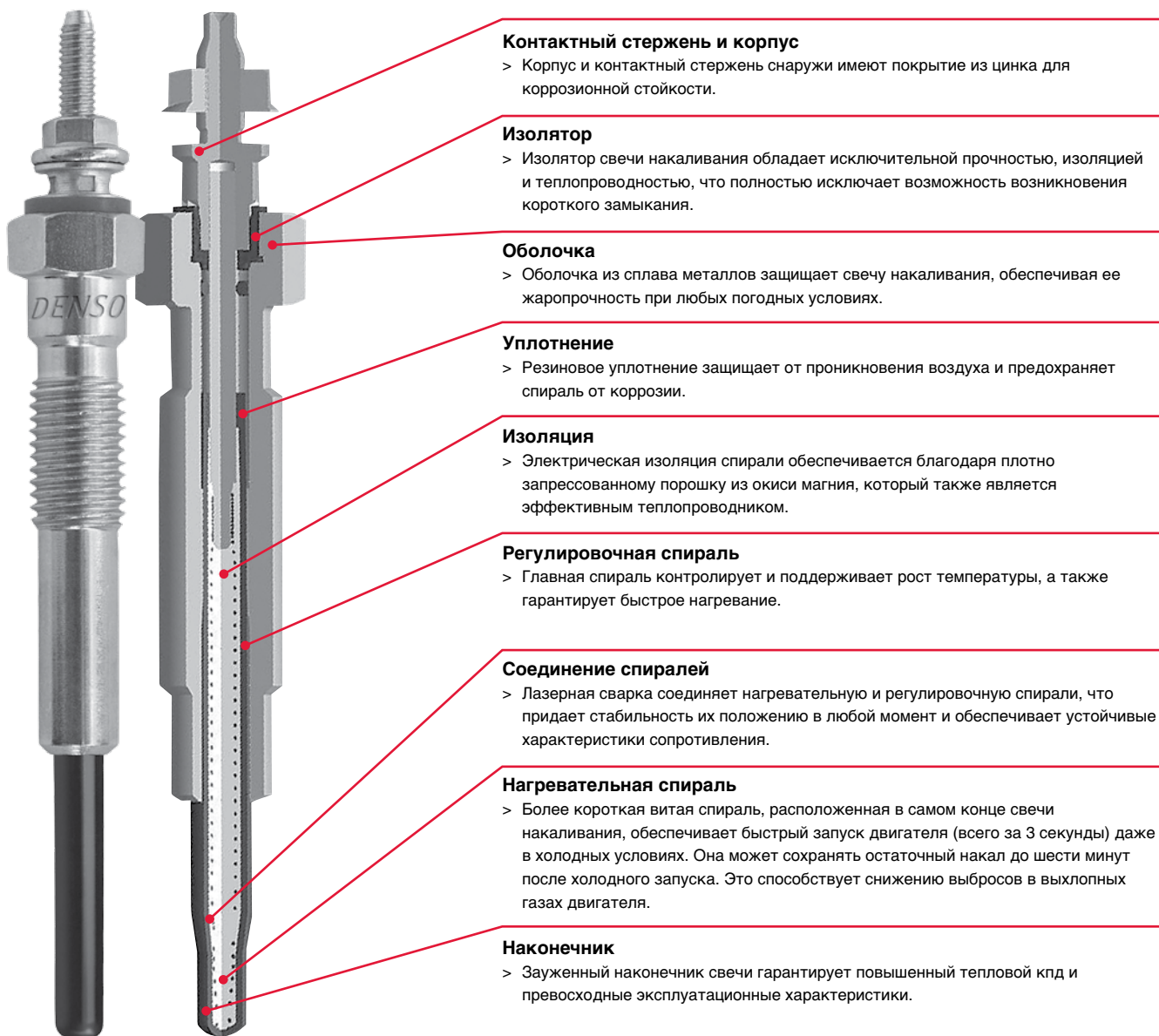

Контактный стержень и корпус

> Корпус и контактный стержень снаружи имеют покрытие из цинка для коррозионной стойкости.

Изолятор

> Изолятор свечи накаливания обладает исключительной прочностью, изоляцией и теплопроводностью, что полностью исключает возможность возникновения короткого замыкания.

Оболочка

> Оболочка из сплава металлов защищает свечу накаливания, обеспечивая ее жаропрочность при любых погодных условиях.

Уплотнение

> Резиновое уплотнение защищает от проникновения воздуха и предохраняет спираль от коррозии.

Изоляция

> Электрическая изоляция спирали обеспечивается благодаря плотно запрессованному порошку из окиси магния, который также является эффективным теплопроводником.

Регулирующая спираль

> Главная спираль контролирует и поддерживает рост температуры, а также гарантирует быстрое нагревание.

Соединение спиралей

> Лазерная сварка соединяет нагревательную и регулировочную спирали, что придает стабильность их положению в любой момент и обеспечивает устойчивые характеристики сопротивления.

Нагревательная спираль

> Более короткая витая спираль, расположенная в самом конце свечи накаливания, обеспечивает быстрый запуск двигателя (всего за 3 секунды) даже в холодных условиях. Она может сохранять остаточный накал до шести минут после холодного запуска. Это способствует снижению выбросов в выхлопных газах двигателя.

Наконечник

> Зауженный наконечник свечи гарантирует повышенный тепловой КПД и превосходные эксплуатационные характеристики.

New Spark Plugs Types

DENSO P/N	MAKE	MODEL
DXE22HQR-D11S	HONDA	ODYSSEY (RC1, RC2) (13-)
FK16R-A8	TOYOTA	AQUA (11-)
FXU16HR11	KIA	SORENTO II (09-)
IK16TT	HYUNDAI	MATRIX (01-10), TUCSON (04-10)
	MAZDA	2 (07-), 3 (00-09)
	SEAT	IBIZA III (6K2) (99-02), IBIZA IV (6L) (02-09)
	TOYOTA	PRIUS (03-09)
	VW	GOLF IV (1J, 1E) (97-06), LUPO (6X, 6E) (98-05), POLO (6N2) (99-01), POLO (9N) (01-09)
IK20TT	HONDA	CR-V II (01-06), CR-V III (06-)
	SEAT	IBIZA IV (6L) (02-09), IBIZA V (6J) (08-)
	SKODA	FABIA (06-14)
	SUZUKI	JIMNY (98-), SWIFT III (05-), SX4 (06-)
	TOYOTA	CAMRY (06-11), RAV 4 II (00-05), RAV 4 III (05-)
IKBH20TT	VW	GOLF V (1K) (03-09), GOLF VI (5K, 517, AJ5) (08-), POLO (9N) (01-09), POLO (6R, 6C) (09-)
	LEXUS	GS (05-11), GS (12-), IS C (09-), IS II (05-), LS (06-)
	HYUNDAI	SANTA FÉ II (06-)
IKH16TT	INFINITI	FX (03-)
	MINI	ASX (10-), COLT VI (04-), LANCER (07-)
	NISSAN	MICRA III (03-10), MICRA IV (10-), NOTE (06-), TEANA (03-08)
	PEUGEOT	607 (00-)
	TOYOTA	CAMRY (11-), IQ (09-), YARIS (10-)
IKH20TT	DAIHATSU	SIRION (05-)
	HONDA	CIVIC VIII Saloon (05-), INSIGHT (09-)
	MERCEDES-BENZ	C-CLASS (203) (00-07), CLK (209) (02-10), E-CLASS (211) (02-09), SLK (R171) (04-11)
	MITSUBISHI	COLT VI (04-), LANCER (07-)
	NISSAN	MURANO (03-)
	SUBARU	FORESTER (02-), FORESTER (08-)
	TOYOTA	CAMRY (11-), IQ (09-), YARIS (10-)
IQ16TT	CHEVROLET	MATIZ (05-)
	PEUGEOT	106 I (91-96)
	RENAULT	CLIO I (90-98), MEGANE I (96-03), MEGANE Scénic (96-99)
	SKODA	FAVORIT (78) (89-97), FELICIA Fun (97-02), FELICIA I (6U) (94-98)
	TOYOTA	CARINA E (92-97), COROLLA (E10) (92-99)
	FIAT	PUNTO (93-00), UNO (83-00)
IQ20TT	FORD	ESCORT VII (95-01)
	LADA	PRIORA (2170, 2171, 2172) (08-)
	LANCIA	Y (95-03)
	MERCEDES-BENZ	C-CLASS (202) (93-01)
	SAAB	9-5 (97-)

DENSO P/N	MAKE	MODEL
IT16TT	FORD	COUGAR (98-01), FIESTA IV (95-02), MONDEO II (96-00), MONDEO III (00-07)
	FORD USA	EXPLORER (93-01), MUSTANG (04-)
	MAZDA	121 III (96-03), 5 (05-), 6 (02-07), 6 (07-), MX-5 III (05-)
IT20TT	FORD	FIESTA I (76-86), FIESTA V (01-08), FOCUS C-MAX (03-07), FOCUS I (98-05), FOCUS II (04-), MAVERICK (01-), MONDEO III (00-07), TRANSIT (06-)
	MAZDA	MPV II (99-06), TRIBUTE (00-08)
	VOLVO	S40 II (04-), V50 (04-)
ITF16TT	CHEVROLET	ASTRO (84-94), BLAZER (S10) (94-05), CAMARO (70-81), CAMARO (81-92)
	PONTIAC	FIREBIRD (81-92), TRANS SPORT (89-97)
ITF20TT	CHEVROLET	CAMARO (92-02), C-K SERIE (94-00), SUBURBAN (91-00)
	PONTIAC	FIREBIRD (92-)
ITL16TT	CHEVROLET	CAPTIVA (06-)
	CHRYSLER	300 C (04-12), PT CRUISER (00-10), VOYAGER (00-08)
	DODGE	CARAVAN (00-07)
	JEEP	CHEROKEE (01-08), GRAND CHEROKEE III (05-10), WRANGLER II (96-08)
ITV16TT	OPEL	ANTARA (06-)
	FORD	FIESTA IV (95-02), FIESTA V (01-08), FOCUS I (98-05), FOCUS II (04-), FUSION (02-), KA (96-08), MONDEO II (96-00)
	MAZDA	2 (03-), 5 (05-), 6 (07-), MX-5 III (05-)
ITV20TT	OPEL	VECTRA C (02-), ZAFIRA A (99-05)
	FORD	C-MAX II (10-), FIESTA VI (08-), FOCUS III (11-), GRAND C-MAX (10-), KUGA II (13-), MONDEO IV (07-)
	MAZDA	5 (05-), 5 (10-), 6 (07-), MX-5 III (05-)
	OPEL	GT (07-), INSIGNIA (08-)
	VOLVO	V40 (12-), V60 (10-), V70 III (07-)
IW16TT	DAEWOO	MATIZ (98-), TICO (95-00)
	MITSUBISHI	COLT V (95-03)
	OPEL	CORSA B (93-00)
	RENAULT	SUPER 5 (84-96), TWINGO I (93-)
IW20TT	SUZUKI	ALTO III (93-02), VITARA (88-99)
	FIAT	CINQUECENTO (91-99), PANDA (80-04), SEICENTO (98-10), UNO (83-00)
	LADA	1200-1600 (70-90), NOVA (81-), SAMARA (86-)
	MITSUBISHI	LANCER IV (88-94), LANCER VII (03-), OUTLANDER I (03-06)
	TOFAS	DOGAN (76-02), SAHIN (80-03)
VW	GOLF III (1H, 1E) (91-99), POLO (6N1) (94-99)	

New Spark Plugs Types

DENSO P/N	MAKE	MODEL	
IXEH20ETT	NISSAN	JUKE (10-), MICRA IV (10-)	
	CITROËN	C3 I (02-), C4 I (LC) (04-)	
	NISSAN	NOTE (06-), QASHQAI (+2) (07-)	
	PEUGEOT	207 (06-)	
IXEH20TT	RENAULT	CLIO II (98-), CLIO III (05-), MODUS (04-), TWINGO I (93-), TWINGO II (07-)	
	TOYOTA	AYGO (05-), YARIS (10-)	
	LEXUS	CT (10-)	
	MAZDA	CX-5 (11-)	
IXEH22TT	NISSAN	MURANO (07-)	
	SUBARU	FORESTER (08-)	
	TOYOTA	AURIS (06-), AURIS (12-), PRIUS (09-), RAV 4 III (05-), URBAN CRUISER (07-), VERSO (09-), VERSO S (10-), YARIS (05-), YARIS (10-)	
		DAIHATSU	MATERIA (06-), SIRION (05-), TERIOS (05-)
		JEEP	CJ5 - CJ8 (66-87)
VXU22I	DAIHATSU	MATERIA (06-), SIRION (05-), TERIOS (05-)	
VXUHC22G	AUDI	Q7 (4L) (06-)	
	HONDA	ACCORD VIII (08-)	
	PORSCHE	CAYENNE (955) (02-10)	
	VW	PASSAT (3C) (05-11), PHAETON (3D) (02-), TOUAREG (7L) (02-10), TOUAREG (7P) (10-)	
		DAIHATSU	ESSE (05-), MIRA GINO (06-), TANTO (02-)
XU20HR9	TOYOTA	PIXIS (11-)	
	HYUNDAI	i10 (13-), i20 (08-)	
XUH20TTi	KIA	PICANTO (11-), RIO III (11-)	

Spark Plugs | Range Updates

Discontinued/Superseded

DENSO P/N	SUPERSEDED BY	DISCONTINUED
FC20HPR8	IXEH22TT	
FK16HQR11	IKH16TT	
FK16HR11	IKH16TT	
FK16PR11	IK16TT	
FK20HQR10	IKH20TT	
FK20HQR8	IKH20TT	
FXE22HR11	IXEH22TT	
IK20C11	IK20TT	
IRE01-35		x
IU22D	IU22	
IU31D	IU31	
IUH22D	IUH24D	
IXU22C	IXU22	
J14CR-U	J16CR-U	
J14C-U	J16CR-U	
J16A-U11	J16AR-U11	
J16AY		x
J16AYR		x
J16BR-U11	J16BR-U	
J16B-U11	J16BR-U	
J16C-U	J16CR-U	
J16HR-U10	J16BR-U	
J20AY		x
K16DTR-S11		x
K16PR-P11	IK16TT	
K16PR-TP11	IK16TT	
K16PR-UR	IK16TT	
K16PR-ZU11	IK16TT	
K16P-U	K16PR-U	
K16P-U11	K16PR-U11	
K16PZR13	IK16TT	
K16R-ZU11	IK16TT	
K16SR14	IK16TT	
K16-U	K16R-U	
K16-U11	K16R-U11	
K20DTR-S11		x
K20PR-L11S		x
K20PR-SU9	IK20TT	
K20PR-TP11	IK20TT	
K20PR-U9S	IK20G	
K20PR-UR	IK20TT	
K20PR-ZU11	IK20TT	
K20PTR-S	IK20TT	
K20P-U11	K20PR-U11	
K20R-ZU11	IK20TT	
K20SR11	IK20TT	
K20SR14	IK20TT	
K20-U	K20R-U	
K20-U11	K20R-U11	
K22P11	IK22	
K22PR-UR	IK22	
K22PR-ZU	IK22	
K22TM11	IK22	
K22TMR11	IK22	
K22TNR	K22TNR-S	
K24PR-ZU	IK24	
K27A-Z	IK27	
K27PR-ZU	IK27	
K29A-Z	IK31	
K31A-Z	IK31	
KJ16CR	KJ16CR11	
KJ20CR11	KJ20CR-U11	

DENSO P/N	SUPERSEDED BY	DISCONTINUED
KJ20DR-M11S	SKJ20DR-M11S	
KJ22CR11	KJ22CR-L11	
LP20-U	IW20TT	
LP20-U	IW20TT	
MA9PR-U	MA9P-U	
MA16PR-U11	MA16PR-U	
MA16P-U	MA16PR-U	
MA16R-U	MA16PR-U	
MA20R-U	MA20PR-U	
MA20R-U11	MA20PR-U	
MW9	MW17	
MW22		x
P16PR8	P16PR11	
P16R8	IW16TT	
P20PR8	P20PR11	
P20PR-P8	IW20TT	
P20PR-S11	P20PR11	
P20R11	IW20TT	
P20R8	IW20TT	
PK20R-P8	IK20TT	
PK22PR-L11	PK22PR-L11S	
PKJ20CR-L13	PKJ20CR-L11	
PQ16R13	IQ16TT	
PQ16R-P11	IQ16TT	
PQ20R13	PQ20R	
PQ20R8	PQ20R	
PQ20R-P11	IQ20TT	
PT16EPR10	PT16EPR-L13	
PT16EPR13	PT16EPR-L13	
PT16EPR-C13	IT16TT	
PTJ14R15	IT16TT	
Q16PR-TP11	IQ16TT	
Q16PR-U15	Q16PR-U11	
Q16PR-ZU11	IQ16TT	
Q16R-ZU11	IQ16TT	
Q16-U	Q16R-U	
Q16-U11	Q16R-U11	
Q16-ZU11	IQ16TT	
Q20PR-P11	IQ20TT	
Q20PR-ZU11	IQ20TT	
Q20R-ZU11	IQ20TT	
Q20-U	Q20R-U	
Q20-U11	Q20R-U11	
Q20-ZU11	IQ20TT	
Q22PR-P11	IQ22	
Q22PR-ZU	IQ22	
Q22PR-ZU11	IQ22	
Q24PR-ZU	IQ24	
Q27PR-ZU	IQ27	
Q29A-Z	IQ31	
Q31A-Z	IQ31	
QJ14C11	QJ16CR11	
QJ16C11	QJ16CR11	
QL20PR-U		x
QL20TR-S		x
QL22TR-S		x
QL22VR-ZU		x
S20R8-G	IW20TT	
S-25	IRE01-27	
S-27	IRE01-27	
S-29	IRE01-27	
S-29A	IRE01-27	

Spark Plugs | Range Updates

Discontinued/Superseded

DENSO P/N	SUPERSEDED BY	DISCONTINUED
SF-10	SF-50	
SK16PR-E13	SK16PR-E11	
SK16PR-F8	IK16TT	
SK16R8-PG	IK20TT	
SK20HPR-L11	IKH20TT	
SK20PR-B8	IK20TT	
SK20PR-F8	IK20TT	
SK20PR-L9S	VK20G	
SK20R5		x
SK20R8	IK20TT	
SK20R8-G	IK20TT	
SVK20RZ11	IK20TT	
SVK20RZ8	IK20TT	
SXU16HPR9		x
SXU22HPR9	VXUH22I	
SXU22HR9	VXUH22I	
SXU22PR-A9	VXU22	
T14PR-U15	T14PR-U	
T16EX-U	T16EPR-U	
T16PR-U20	T16PR-U15	
T16R-U15	T16R-U	
T16-U15	T16R-U	
T20EP-U15	T20EPR-U15	
T20EX-U	T20EP-U	
TJ14R-P15	IT16TT	
TJ16R15	PTJ16R15	
TR20	W20FS-U	
TR22	W22FS-U	
TR24	W24FS-U	
TR24-10	W24FS-U10	
U14FS-UB	U14FSR-UB	
U16FS-L	U16FS-U	
U20FER9		x
U20FS-ZU	IUF22	
U20M-U		x
U22FS-ZU	IUF22	
U24ESR-NZU	IU24	
U24FER9S	IUH24	
U24FER-ZU9	IUH24	
U24FE-ZU9	IUH24	
U24FS-C	U24FS-U	
U24FS-L	U24FS-U	
U24FSR-C	U24FSR-U	
U27ESR-NZU	IU27	
U27FE9	U27FER9	
U27FER-ZU9	IUH27	
U31ESR-NZU	IU31	
U31ESR-PT	IU01-31	
U31FER9	U31ESR-N	
U31FER-ZU9	IU31	x
U31FS-ZU		x
U34ES-NZU	IU01-34	
U34ESR-PT	IU01-34	
U34FER-ZU9	IU01-34	
U34FS-ZU		x
U37ESR-PT		x
VW16R-A13	IW16TT	
W9EPR	W9EXR-U+CU	
W9EXR-U	W9EXR-U+CU	
W9FP-L	W9FP-UL	
W9PR-U15	W9PR-U	
W9PR-U20	W9PR-U	

DENSO P/N	SUPERSEDED BY	DISCONTINUED
W9P-U	W9PR-U	
W14		x
W14EKR-S11		x
W14EP	W14EPR-U	
W14EPR	W14EPR-U	
W14EPR11	W14EXR-U11	
W14EP-U	W14EPR-U	
W14EXR-U13	W14EXR-U11	
W14EXR-U15	W14EXR-U11	
W14EXR-ZU	IW16TT	
W14EX-U11	W14EXR-U11	
W14EX-U13	W14EXR-U11	
W14FP	W14FPR-U	
W14FP-L	W14FP-UL	
W14FPR	W14FPR-U	
W14FPR-L	W14FPR-UL	
W14F-U10	W14F-U	
W14LMR-US	W14LM-US	
W14M-U	W14MR-U	
W14M-U10	W14MR-U	
W14M-US	W14MR-U	
W14PR-U15	W14PR-U	
W14P-U	W14PR-U	
W14-U	W14PR-U	
W14-U10	W14PR-U	
W16DTR-S		x
W16EK-S11	W16EKR-S11	
W16EP	W16EP-U	
W16EP11	W16EPR-U11	
W16EPR	W16EPR-U	
W16EPR11	W16EPR-U11	
W16EPR-S11	W16EPR-U11	
W16EPR-U10	W16EPR-U11	
W16EP-ZU	IW16TT	
W16ES-L	W16ES-U	
W16ESR-L	W16ESR-U	
W16ET-L	W16ETR-S	
W16ET-S	W16ETR-S	
W16EX-GU	IW16TT	
W16EXR-ZU	IW16TT	
W16EX-U11	W16EXR-U11	
W16EX-U13	W16EXR-U13	
W16EX-ZU	IW16TT	
W16FP	W16FP-U	
W16FP-L	W16FP-U	
W16FPR	W16FPR-U	
W16FP-U10	W16FPR-U	
W16FP-UL	W16FP-U	
W16FS-ZU		x
W16PR-U15	W16PR-U	
W16P-U	W16PR-U	
W20DTR-S		x
W20DTR-SA		x
W20EA		x
W20EAR		x
W20EBR	W22EBR	
W20EK-S11	W20EKR-S11	
W20EP	W20EP-U	
W20EP11	W20EPR-U11	
W20EPR	W20EPR-U	
W20EPR-U10	W20EPR-U11	
W20EPR-ZU	IW20TT	

Spark Plugs | Range Updates

Discontinued/Superseded

DENSO P/N	SUPERSEDED BY	DISCONTINUED
W20EPR-ZU11	IW20TT	
W20EP-S11	W20EPR-S11	
W20EP-U11	W20EPR-U11	
W20EP-ZU	IW20TT	
W20ES-L	W20EKR-S11	
W20ES-L11	W20EKR-S11	
W20ESR-L	W20EKR-S11	
W20ESR-L11	W20EKR-S11	
W20ES-ZU		x
W20ET-L	W20ETR-L	
W20ETR	W20ETR-L	
W20ETR-L8	W20ETR-L	
W20ETR-S	IW20TT	
W20ET-S	IW20TT	
W20EVR-ZU	IW20TT	
W20EXR-U13	W20EXR-U11	
W20EXR-ZU	IW20TT	
W20EX-U11	W20EXR-U11	
W20EX-U13	W20EXR-U11	
W20EX-ZU	IW20TT	
W20FP	W20FP-U	
W20FPR	W20FPR-U	
W20FPR-L	W20FR-L	
W20FPR-ZU	IWF20	
W20FR-L9	W20FR-L	
W20FS	W20FS-U	
W20FSR	W20FSR-U	
W20FS-U10	W20FS-U	
W20FS-ZU	IWF20	
W20FT-U	W20FP-U	
W20MP-U10	W20MPR-U10	
W20M-U	W20MR-U	
W20P-U	W20PR-U	
W21ES-L11	W20EKR-S11	
W21ESR-L11	W20EKR-S11	
W22EA	W22EBR	
W22EAR	W22EBR	
W22EB	W22EBR	
W22EDR	IRE01-27	
W22EDR14	IRE01-27	
W22EKR-S11	IW22	
W22EK-S11	IW22	
W22EP	W22EP-U	
W22EP11	W22EPR-U11	
W22EPR	W22EPR-U	
W22EPR11	W22EPR-U11	
W22EPR-S11	IW22	
W22EPR-ZU	IW22	
W22EPR-ZU11	IW22	
W22EP-S11	IW22	
W22EP-U11	W22EPR-U11	
W22EP-ZU	IW22	
W22ES	W22ES-U	
W22ES-L	IW22	
W22ES-L11	IW22	
W22ESR	W22ESR-U	
W22ESR-L	IW22	
W22ESR-L11	IW22	
W22ES-U11	W22ES-U	
W22ES-ZU	IW24	
W22ET-L	W22ETR-L	
W22ETR-L8	W22ETR-L	

DENSO P/N	SUPERSEDED BY	DISCONTINUED
W22EXR-U	W22EPR-U	
W22EXR-U11	W22EPR-U11	
W22EX-U	W22EP-U	
W22FP	W22FP-U	
W22FPR	W22FPR-U	
W22FPR-ZU	IWF22	
W22FP-U10	W22FP-U	
W22FS-U10	W22FS-U	
W22FS-ZU	IWF22	
W22MP-US	W22MP-U	
W22M-US	W22M-U	
W24EP	W24EPR-U	
W24EP11	W24EP-U	
W24EPR	W24EPR-U	
W24EPR-ZU	IW24	
W24ES	W24ES-U	
W24ESR-ZU	IW24	
W24ES-ZU	IW24	
W24FP	W24FP-U	
W24FPR-L	W24FPR	
W24FS	W24FS-U	
W24FS-ZU	IWF24	
W25EA	W27EBR	
W25EAR	W27EBR	
W25EB	W27EBR	
W25EBR	W27EBR	
W25EDR	IRE01-27	
W25EDR14	IRE01-27	
W25EN	IW01-24	
W25EPT	IW01-24	
W25FN	IWF24	
W27A-Z	IW27	
W27EDR14	IRE01-27	
W27EMR-ZU	IWM27	
W27EN	IW01-27	
W27EPT	IW01-27	
W27ES	W27ES-U	
W27ES-C	W27ES-U	
W27ESR-ZU	IW27	
W27ES-ZU	IW27	
W27FN	IWF27	
W27FS-ZU	IWF27	
W29A-Z	IW29	
W29EPT	IW01-29	
W29ESR-V	IW29	
W29ES-V	IW29	
W29ES-ZU	IW29	
W31A-Z	IW31	
W31EMR-C	IWM31	
W31EMR-ZU	IWM31	
W31EPT	IW01-31	
W31ESR-ZU	IW31	
W31ES-ZU	IW31	
W31FN		x
W31FPt		x
W31FS-ZU		x
W31S-U		x
W32EPT	IW01-32	
W34EMR-ZU	IWM01-34	
W34EN	IW01-34	
W34ES-ZU	IW34	
W34FN		x

Discontinued/Superseded









DENSO P/N	SUPERSEDED BY	DISCONTINUED
W34FPT		x
W35EPT	IW01-34	
W37EPT		x
W37FN		x
W37FPT		x
X16EP-U9	X16EPR-U9	
X16FS-U	X16FSR-U	
X20EP-U9	X20EPR-U9	
X20FS-ZU	X20FS-U	
X22EPR-GL	IX22B	
X22EPR-ZU9	IX22B	
X22EP-U	X22EP-U9	
X22ESR-UB	IX22	
X22ES-ZU	IX22	
X22GPR-U	IXG24	
X22GP-U	IXG24	
X24EPR-GL	IX24B	
X24EPR-ZU9	IX24B	
X24EP-U	X24EP-U9	
X24ESR-ZU	IX24	
X24ES-ZU	IX24	
X24FSR-U	X24FS-U	
X24FS-ZU		x
X24GP-U	X24GPR-U	
X27EPR-ZU9	IX27B	
X27ESR-ZU	IX27	
X27ES-ZU	IX27	
X27GP-U	X27GPR-U	
X29ES-ZU		x
X34ES-ZU	IXU01-34	
XU20EPR-ZU	IXU22	
XU20EP-U	XU20EPR-U	
XU20EP-ZU	IXU22	
XU22EP-P	IXU22	
XU22EPR-ZU	IXU22	
XU22EP-U	XU22EPR-U	
XU22HR9	XU22HDR9	
XU24EPR-ZU	IXU24	
XU24EP-U	XU24EPR-U	
XU24EP-ZU	IXU24	
XU27EPR-ZU	IXU27	
Y24ESR-NZU		x
Y27FER	Y24FER-C	
Z4		x
Z4K		x
Z9		x
ZC20HPR11	VCH20	
ZT16EPR11	IT16TT	
ZTJ16R10	IT16TT	
ZXE20HR13	IXEH20TT	
ZXE27HBR8	VXEBH27	
ZXU22PR11	VXU22	







New Applications







MAKE	MODEL
ALFA ROMEO	147 (00-10), MITO (08-)
BMW	5 (E60, E61) (03-10), X5 (E70) (07-13)
CHEVROLET	AVEO (T300) (11-), CAPTIVA (06-), LACETTI (05-)
CITROEN	C8 (02-), C-CROSSER (07-), JUMPY (07-)
DACIA	DOKKER (12-), LOGAN MCV I (07-), SANDERO I (08-)
DODGE	JOURNEY (08-)
FIAT	500 (C) (07-), 500L (12-), DOBLO (01-), FIORINO (07-), LINEA (07-), PUNTO (12-), PUNTO EVO (08-12)
FORD	B-MAX (12-), C-MAX I (07-), C-MAX II (10-), GALAXY (06-), KUGA II (13-), MONDEO IV (07-), RANGER (06-), S-MAX (06-), TOURNEO / GRAND TOURNEO Connect (13-), TRANSIT (06-), TRANSIT Connect (13-)
GAZ	GAZELLE (93-01)
ISUZU	KB (10-)
JEEP	GRAND CHEROKEE IV (10-)
KIA	CEE'D (12-)
LANCIA	MUSA (04-), PHEDRA (02-10), YPSILON (846) (11-)
LAND ROVER	88 / 109 (61-86), FREELANDER II (06-14)
MAZDA	626 IV (91-97), E-SERIE (SD) (83-04)
MERCEDES-BENZ	GLK (X204) (08-)
MINI	CANTER (96-01), L 200 (96-07), OUTLANDER II (06-12), JUKE (10-), NOTE (06-), PRIMASTAR (01-), QASHQAI (+2) (07-)
OPEL	ANTARA (06-), ASTRA F CLASSIC (98-05), ASTRA J (09-), CORSA D (06-), INSIGNIA (08-), MERIVA A (03-10), MERIVA B (10-), ZAFIRA C (11-)
PEUGEOT	4007 (07-), 407 (04-), 807 (02-)
RENAULT	CLIO III (05-), GRAND SCÉNIC III (09-), KANGOO (08-), LAGUNA III (07-), MEGANE III (08-), SCÉNIC III (09-)
RENAULT TRUCKS	MASCOTT (99-10)
SMART	FORTWO (451) (07-)
SUZUKI	GRAND VITARA (05-), SX4 S-Cross (13-)
TOYOTA	LAND CRUISER (J200) (07-), LAND CRUISER / PRADO (J70) (84-06), URBAN CRUISER (07-), VERSO S (10-), YARIS (10-)
VAUXHALL	ASTRA VI (J) (09-), COMBO III (D) (11-), INSIGNIA (08-), MERIVA I (A) (03-10), MERIVA II (B) (10-)
VOLVO	C30 (06-12), C70 II (06-), S40 II (04-), S60 II (10-), S80 II (06-), V40 (12-), V50 (04-), V60 (10-), V70 II (00-07), V70 III (07-), XC60 (08-), XC70 II (07-), XC90 I (02-)

New Glow Plug Types







DENSO P/N	MAKE	MODEL
DG-600	TOYOTA	LAND CRUISER (J200) (07-)
DG-602	KIA	CEE'D (12-)
DG-603	CITROËN	JUMPY (07-)
	FORD	B-MAX (12-), C-MAX I (07-), C-MAX II (10-), GALAXY (06-), KUGA II (13-), MONDEO IV (07-), TOURNEO / GRAND TOURNEO Connect (13-), TRANSIT Connect (13-)
	PEUGEOT	PARTNER / RANCH (08-)
DG-604	CHEVROLET	CAPTIVA (06-), LACETTI (05-)
	OPEL	ANTARA (06-)
DG-605	RENAULT	MASTER II (98-)
DG-608	RENAULT TRUCKS	MASCOTT (99-10)
	CHRYSLER	DELTA (11-)
	OPEL	INSIGNIA (08-), ZAFIRA C (11-)
	SUZUKI	SX4 S-Cross (13-)
DG-609	VAUXHALL	ASTRA VI (J) (09-), COMBO III (D) (11-), INSIGNIA (08-)
	DACIA	DOKKER (12-), LOGAN MCV I (07-), SANDERO I (08-)
	NISSAN	CUBE (10-), JUKE (10-), NOTE (06-), QASHQAI (+2) (07-)
DG-610	RENAULT	GRAND SCÉNIC III (09-), KANGOO (08-), LAGUNA III (07-), MEGANE III (08-), SCÉNIC III (09-)
	VOLVO	C30 (06-12), C70 II (06-), S40 II (04-), S60 II (10-), S80 II (06-), V50 (04-), V60 (10-), V70 III (07-), XC60 (08-), XC70 II (07-), XC90 I (02-)
DG-614	CITROËN	C5 III (08-), C6 (05-), C8 (02-), C-CROSSER (07-)
	FORD	GALAXY (06-), S-MAX (06-)
	LANCIA	PHEDRA (02-10)
	LAND ROVER	FREELANDER II (06-14)
	MITSUBISHI	OUTLANDER II (06-12)
DG-619	PEUGEOT	4007 (07-), 407 (04-), 807 (02-)
DG-619	RENAULT	GRAND SCÉNIC III (09-), MEGANE III (08-), SCÉNIC III (09-)
DG-621	ALFA ROMEO	MITO (08-)
	CHEVROLET	AVEO (T300) (11-)
	FIAT	500 (C) (07-), 500L (12-), FIORINO (07-), GRANDE PUNTO (05-), LINEA (07-), PUNTO (12-), PUNTO EVO (08-12)
	LANCIA	MUSA (04-), YPSILON (846) (11-)
	OPEL	ASTRA J (09-), CORSA D (06-), MERIVA B (10-)
	VAUXHALL	ASTRA VI (J) (09-), MERIVA II (B) (10-)





	KW					Standard			Twin Tip			QTY
AC												
ACE (95-98)												
4.9	191	99E		01/95-10/98	T16PR-U11	5026	1.1	-		ITF16TT	ITF16TT	8
COBRA IV (90-)												
4.9	184/250	99F; 99UM		01/90-10/97	T16PR-U11	5026	1.1	-		ITF16TT	ITF16TT	8
4.9 Roadster	168	99H		09/97-08/99	T16PR-U11	5026	1.1	-		ITF16TT	ITF16TT	8
4.9 Super Charger	239	99F		10/97-	T16PR-U11	5026	1.1	-		ITF16TT	ITF16TT	8
ACURA												
MDX (00-05)												
3.5 All-wheel Drive	179/186/193	J35A3; J35A4		08/00-12/05	SKJ20DR-M11	3377	1.1	-		IK20TT	IK20TT	6
NSX (90-)												
3.2	206	C32B2		08/97-	PK20PR-L11	3142	1.1	-		IK20TT	IK20TT	6
R 3.0	188	C30A4		01/92-08/97	PK20PR-L11	3142	1.1	-		IK20TT	IK20TT	6
NSX Targa (95-97)												
3.0	201	C30A3		01/95-12/96	PK20PR-L11	3142	1.1	-		IK20TT	IK20TT	6
T 3.0	188	C30A4		01/95-12/97	PK20PR-L11	3142	1.1	-		IK20TT	IK20TT	6
ALFA ROMEO												
33 (83-93)												
1.2 (905.A)	50	AR 30585		06/83-12/89	W22EPR-U	3088	0.8	W22TT	-	VW22		4
1.3	58	AR 30502		05/83-12/89	W22EPR-U	3088	0.8	W22TT	-	VW22		4
1.3 (905.A1A, 905.A1C, 905.A1D, 905.A1F, 905.A1H)	63	AR30168;AS30568		10/84-12/89	W22EPR-U	3088	0.8	W22TT	-	VW22		4
1.3 (905.A1B, 905.A1C, 905.A1G)	55	AR30512		06/83-07/86	W22EPR-U	3088	0.8	W22TT	-	VW22		4
1.3 i.e.	66	AR 30168		09/86-12/89	W22EPR-U	3088	0.8	W22TT	-	VW22		4
1.4	66	AS30168;AS30587		07/88-12/88	W22EPR-U	3088	0.8	W22TT	-	VW22		4
1.5	70	AR30514;AR30526		05/83-07/87	W22EPR-U	3088	0.8	W22TT	-	VW22		4
1.5 (905.A2)	75	AR30146;AR30182		07/86-12/89	W22EPR-U	3088	0.8	W22TT	-	VW22		4
1.5 (905.A2A)	62	AR30504		06/83-12/85	W22EPR-U	3088	0.8	W22TT	-	VW22		4
1.5 (905.A2G)	66	AR30520		08/85-12/86	W22EPR-U	3088	0.8	W22TT	-	VW22		4
1.5 4x4 (905.A2)	62	AR30504		11/83-12/84	W22EPR-U	3088	0.8	W22TT	-	VW22		4
1.5 4x4 (905.A2A)	70	AR30514;AR30526		01/84-12/89	W22EPR-U	3088	0.8	W22TT	-	VW22		4
1.5 4x4 (905.A2B, 905.A2C)	66	AR30520		09/84-12/86	W22EPR-U	3088	0.8	W22TT	-	VW22		4
1.5 4x4 (905.A2F)	66	AR30520		01/85-09/86	W22EPR-U	3088	0.8	W22TT	-	VW22		4
1.5 4x4 (905.A2M, 905.A2T)	77	AR30146		09/86-12/89	W22EPR-U	3088	0.8	W22TT	-	VW22		4
1.5 4x4 (905.A2U)	77	AR30146;AR30182; AS30508		12/86-03/89	W22EPR-U	3088	0.8	W22TT	-	VW22		4
1.5 QV (905.A2N, 905.A2V)	77	AR30146;AR30182; AR30526		06/84-07/86	W22EPR-U	3088	0.8	W22TT	-	VW22		4
1.7	87	AS30550;AS30558		03/88-12/89	W22EPR-U	3088	0.8	W22TT	-	VW22		4
1.7 i.e. (905.A3D)	77	AR30558		09/88-12/89	W22EPR-U	3088	0.8	W22TT	-	VW22		4
1.7 i.e. 4x4	77	AS30558		09/88-12/89	W22EPR-U	3088	0.8	W22TT	-	VW22		4
1.7 QV (905.A3)	84	AR 30550		03/88-12/89	W22EPR-U	3088	0.8	W22TT	-	VW22		4
1.8 TD	54/62	VM 82 A; VM 96 A		01/86-06/90	DG-202		11V					3
33 (90-94)												
1.4 i.e.	65/66	AR30732; AR30755		06/91-09/94	W22EPR-U	3088	0.8	W22TT	-	VW22		4
1.4 i.e. (907.A3A, 907.A3B)	65/66	AR30732; AR30753;AR30755		06/91-09/94	W22EPR-U	3088	0.8	W22TT	-	VW22		4
1.4 i.e. 4x4	66	AR30753		06/91-09/94	W22EPR-U	3088	0.8	W22TT	-	VW22		4
1.5	77	AR30734		01/90-04/93	W22EPR-U	3088	0.8	W22TT	-	VW22		4
1.5 i.e	71	AR30750;AR30751		01/90-09/94	W22EPR-U	3088	0.8	W22TT	-	VW22		4
1.7 16V	101	AR 30746		01/90-03/92	K20PBR	5060	0.85	K20TT	IK20TT	IK20TT		4
1.7 16V (907.A1B)	101	AR 30746		01/90-03/92	K20PBR	5060	0.85	K20TT	IK20TT	IK20TT		4
1.7 16V (907.A1C)	95/97	AR 30747		01/90-09/94	K20PBR	5060	0.85	K20TT	IK20TT	IK20TT		4
1.7 16V (907.B1G)	95/97	AR 30747		01/90-09/94	K20PBR	5060	0.85	K20TT	IK20TT	IK20TT		4
1.7 16V 4x4 (907.A1G)	95/97	AR 30747		01/90-09/94	K20PBR	5060	0.85	K20TT	IK20TT	IK20TT		4
1.7 16V 4x4 (907.B1H)	95/97	AR 30747		01/90-09/94	K20PBR	5060	0.85	K20TT	IK20TT	IK20TT		4
1.7 16V 4x4 (907A1F)	101	AR 30746		01/90-09/94	K20PBR	5060	0.85	K20TT	IK20TT	IK20TT		4
1.7 i.e. (907.A1A)	77/79	AR 30736; AR 30737 A; AR 30737		01/90-09/94	W22EPR-U	3088	0.8	W22TT	-	VW22		4
1.7 i.e. (907.B1A)	77/79	AR 30736; AR 30737		01/90-09/94	W22EPR-U	3088	0.8	W22TT	-	VW22		4
1.7 i.e. 4x4	79	AR 30736; AR 30737		01/90-03/92	W22EPR-U	3088	0.8	W22TT	-	VW22		4
1.7 i.e. 4x4 (907.B1E)	79	AR 30736; AR 30737		01/90-03/92	W22EPR-U	3088	0.8	W22TT	-	VW22		4
1.8 TD (907A5)	62	VM 96 A		07/90-09/94	DG-202		11V					3
75 (85-92)												
1.6	76	AR61102		05/85-09/89	W20EPR-U	3047	0.8	W20TT	IW20TT	IW20TT		4
1.6 (162.B2B, 162.B2C)	81	AR 06100		05/85-09/89	W22EPR-U	3088	0.8	W22TT	-	VW22		4







	KW					Standard			Twin Tip				QTY	
ALFA ROMEO <i>continued</i>														
75 (85-92) <i>continued</i>														
1.6 (162.B2B, 162.B2C) CAT	81	AR61101		05/89-02/92	W22EPR-U	3088	0.8	W22TT	-	WV22				4
1.8 (162.B1A, 162.B1B)	85	AR06202		09/85-06/89	W22EPR-U	3088	0.8	W22TT	-	WV22				4
1.8 (162.B1H)	95	AR61201		08/89-02/92	W22EPR-U	3088	0.8	W22TT	-	WV22				4
1.8 (162.B1L, 162.B1F)	88	AR06168		09/88-02/92	W22EPR-U	3088	0.8	W22TT	-	WV22				4
1.8 Turbo (162.B1C, 162.B1D, 162.B1G)	110	AR06134		09/86-02/92	W22EPR-U	3088	0.8	W22TT	-	WV22				4
1.8 Turbo i.e. (162.B1E)	114	AR06158; AR61203		02/86-01/90	W22EPR-U	3088	0.8	W22TT	-	WV22				4
2.0 (162.BA)	94	AR06212		05/85-07/87	W22EPR-U	3088	0.8	W22TT	-	WV22				4
2.0 T.S (162.B4A) CAT	109	AR06224		09/88-02/92	K20PBR	5060	0.85	K20TT	IK20TT	IK20TT				4
2.0 T.S. (162.4CB, 162.B4, 162.B4A)	107	AR06166; AR06224		01/87-02/92	K20PBR	5060	0.85	K20TT	IK20TT	IK20TT				4
2.0 TD (162.BD, 162.BG)	70	VM 80 A		05/85-09/92	DG-202		11V							4
2.4 TD	82	VM 81 A		01/89-02/92	DG-202		11V							4
2.5 V6 (162.B3)	115	AR01646		05/85-08/86	W22EPR-U	3088	0.8	W22TT	-	WV22				6
2.5 V6 CAT	113	AR01646; AR01911		09/88-04/89	W22EPR-U	3088	0.8	W22TT	-	WV22				6
3.0 V6 (162.B6A)	136	AR06120		01/87-12/90	W22EPR-U	3088	0.8	W22TT	-	WV22				6
3.0 V6 (162.B6A) CAT	136	AR06120		09/88-02/92	W22EPR-U	3088	0.8	W22TT	-	WV22				6
3.0 V6 (162.B6C)	141	AR61503		02/90-02/92	W22EPR-U	3088	0.8	W22TT	-	WV22				6
90 (84-87)														
1.8	89	AR06202		06/86-07/87	W22EPR-U	3088	0.8	W22TT	-	WV22				4
1.8 (162.A1A)	85	AR06202		10/84-07/87	W22EPR-U	3088	0.8	W22TT	-	WV22				4
2.0 i.e.	97	AR06210		06/86-07/87	W22EPR-U	3088	0.8	W22TT	-	WV22				6
2.0 i.e. (162.A2A, 162.A2E)	94	AR01713; AR06212		10/84-07/87	W22EPR-U	3088	0.8	W22TT	-	WV22				4
2.4 TD (162.B5)	81	VM 81 A		10/84-07/87	DG-202		11V							4
2.5 i.e. V6	114	AR01646		10/84-07/87	W22EPR-U	3088	0.8	W22TT	-	WV22				6
2.5 i.e. V6 (162.A, 162.AA)	110	AR01911		10/84-07/87	W22EPR-U	3088	0.8	W22TT	-	WV22				6
145 / 146 (94-01)														
1.4 i.e.	66	AR33501		07/94-12/96	W22EPR-U	3088	0.8	W22TT	-	WV22				4
1.4 i.e. 16V T.S.	76	AR33503	10 mm diameter+	11/96-01/01	IJ22	5361	0.9	-	-	-				4
1.4 i.e. 16V T.S.	76	AR33503	14 mm diameter+	11/96-01/01	PK20TR11	3253	1.1	K20TT	IK20TT	IK20TT				4
1.6 i.e.	76	AR33201		10/94-12/96	W22EPR-U	3088	0.8	W22TT	-	WV22				4
1.6 i.e. 16V T.S.	88	AR32102; AR67601	10 mm diameter+	11/96-01/01	IJ22	5361	0.9	-	-	-				4
1.6 i.e. 16V T.S.	88	AR32102; AR67601	14 mm diameter+	11/96-01/01	PK20TR11	3253	1.1	K20TT	IK20TT	IK20TT				4
1.7 i.e. 16V	95	AR33401		10/94-12/96	PK20PR-P8	3245	0.8	-	IK20TT	IK20TT				4
1.8 i.e. 16V	106	AR32201	10 mm diameter+	03/98-04/99	IJ22	5361	0.9	-	-	-				4
1.8 i.e. 16V	106	AR32201	14 mm diameter+	03/98-04/99	PK20TR11	3253	1.1	K20TT	IK20TT	IK20TT				4
1.8 i.e. 16V T.S.	103/106	AR32201; AR67106; AR67199; AR67106	10 mm diameter+	11/96-01/01	IJ22	5361	0.9	-	-	-				4
1.8 i.e. 16V T.S.	103/106	AR32201; AR67106; AR67199; AR67106	14 mm diameter+	11/96-01/01	PK20TR11	3253	1.1	K20TT	IK20TT	IK20TT				4
1.9 JTD	77	AR 32302		02/99-01/01	DG-122		11V							4
1.9 JTD	77	AR 32302		02/99-01/01	DG-127		11V							4
1.9 TD	66	AR 33601; AR 67501		10/94-02/99	DG-001		11V							4
2.0 16V Quadrifoglio	114	AR32301	10 mm diameter+	03/98-01/01	IJ22	5361	0.9	-	-	-				4
2.0 16V Quadrifoglio	114	AR32301	14 mm diameter+	03/98-01/01	PK20TR11	3253	1.1	K20TT	IK20TT	IK20TT				4
2.0 16V T.S.	110	AR67204; AR67299; AR67204	10 mm diameter+	10/95-01/01	IJ22	5361	0.9	-	-	-				4
2.0 16V T.S.	110	AR67204; AR67299; AR67204	14 mm diameter+	10/95-01/01	PK20TR11	3253	1.1	K20TT	IK20TT	IK20TT				4
147 (00-10)														
1.6 16V T.SPARK (937AXB1A)	88	AR32104	10 mm diameter+	01/01-03/10	IJ22	5361	0.9	-	-	-				4
1.6 16V T.SPARK (937AXB1A)	88	AR32104	14 mm diameter+	01/01-03/10	PK20TR11	3253	1.1	K20TT	IK20TT	IK20TT				4
1.6 16V T.SPARK ECO (937AXA1A)	77	AR37203	10 mm diameter+	01/01-03/10	U22ETR	4201	0.7	-	-	-				4
1.6 16V T.SPARK ECO (937AXA1A)	77	AR37203	14 mm diameter+	01/01-03/10	K20PBR-S10	5061	1.0	K20TT	IK20TT	IK20TT				4
1.9 JTD	74	182 B9.000		06/03-03/10	DG-122		11V							4
1.9 JTD	81	AR 37101	OE: 46754154	11/00-09/04	DG-122		11V							4
1.9 JTD	81	AR 37101	OE: 55200817	11/00-09/04	DG-196		11V							4
1.9 JTD (937AXD1A)	85	937 A2.000		04/01-03/10	DG-122		11V							4







	KW					Standard		Twin Tip		QTY	
ALFA ROMEO <i>continued</i>											
147 (00-10) <i>continued</i>											
1.9 JTD 16V	93/100/103	192 A5.000; 192 B1.000; 937 A4.000		09/03-03/10	DG-170		11V			4	
1.9 JTDM	85	939 A7.000		10/04-09/05	DG-122		11V			4	
1.9 JTDM 16V	110	937 A5.000		09/04-03/10	DG-170		11V			4	
1.9 JTDM 8V	88	937 A3.000		07/05-03/10	DG-196		11V			4	
2.0 16V T.SPARK (937AXC1_)	110	AR32310	10 mm diameter+	01/01-11/08	IU22	5361	0.9	-	-	4	
2.0 16V T.SPARK (937AXC1_)	110	AR32310	14 mm diameter+	01/01-11/08	PK20TR11	3253	1.1	K20TT	IK20TT	IK20TT	4
3.2 GTA	184	932A.000		02/03-01/06	PK20PR-P8	3245	0.8	-	IK20TT	IK20TT	6
155 (92-97)											
1.6 16V T.S.	88	AR67601	10 mm diameter+	05/96-12/97	IU22	5361	0.9	-	-	-	4
1.6 16V T.S.	88	AR67601	14 mm diameter+	05/96-12/97	PK20TR11	3253	1.1	K20TT	IK20TT	IK20TT	4
1.7 T.S.	83	AR67103		04/93-04/96	Q22PR-U	3010	0.8	-	-	VQ22	4
1.7 T.S. (167.A4D, 167.A4H)	85	AR67105		04/93-03/95	Q22PR-U	3010	0.8	-	-	VQ22	4
1.7 T.S. 16V	103	AR67106	10 mm diameter+	05/96-12/97	IU22	5361	0.9	-	-	-	4
1.7 T.S. 16V	103	AR67106	14 mm diameter+	05/96-12/97	PK20TR11	3253	1.1	K20TT	IK20TT	IK20TT	4
1.8 T.S.	95	AR67101		02/92-06/93	Q22PR-U	3010	0.8	-	-	VQ22	4
1.8 T.S. Sport (167.A4A, 167.A4C, 167.A4E)	93	AR67102		01/92-03/95	Q22PR-U	3010	0.8	-	-	VQ22	4
1.9 TD (167.A3)	66	AR 67501		04/93-12/97	DG-001		11V				4
2.0 16V Turbo Q4	140	AR67203		03/95-12/97	W20EPB	5065	0.85	W20TT	IW20TT	IW20TT	4
2.0 16V Turbo Q4 (167.A2B, 167.A2C, 167.A2E)	137	AR67203		01/92-03/95	W20EPB	5065	0.85	W20TT	IW20TT	IW20TT	4
2.0 T.S. (167.A2)	106	AR67201	14 mm diameter+	02/92-04/93	Q22PR-U	3010	0.8	-	-	VQ22	4
2.0 T.S. (167.A2A)	104	AR67202	14 mm diameter+	02/92-02/95	Q22PR-U	3010	0.8	-	-	VQ22	4
2.0 T.S. 16V (167.A2G)	110	AR67204;AR67299	10 mm diameter+	03/95-12/97	IU22	5361	0.9	-	-	-	4
2.0 T.S. 16V (167.A2G)	110	AR67204;AR67299	14 mm diameter+	03/95-12/97	PK20TR11	3253	1.1	K20TT	IK20TT	IK20TT	4
2.5 TD (167.A1A)	92	VM 07 B; VM 31 B		04/93-04/95	DG-001		11V				4
2.5 TD (167.A1A)	92	VM 07 B; VM 31 B		05/95-12/97	DG-109		11V				4
2.5 V6 (167.A1)	121	AR67301		02/92-03/95	W22EPR-U	3088	0.8	W22TT	-	VW22	6
2.5 V6 (167.A1C, 167.A1E)	120	AR67302;AR67303		10/92-12/97	W22EPR-U	3088	0.8	W22TT	-	VW22	6
156 (97-06)											
1.6 16V T.SPARK (932A4)	88	AR32102;AR32103;AR32104, AR67601	10 mm diameter+	09/97-06/04	IU22	5361	0.9	-	-	-	4
1.6 16V T.SPARK (932A4)	88	AR32102;AR32103;AR32104, AR67601	14 mm diameter+	09/97-06/04	PK20TR11	3253	1.1	K20TT	IK20TT	IK20TT	4
1.6 16V T.SPARK. (932A4)	88	AR32104;AR67601	10 mm diameter+	05/00-06/04	IU22	5361	0.9	-	-	-	4
1.6 16V T.SPARK. (932A4)	88	AR32104;AR67601;AR67601(111)	14 mm diameter+	05/00-06/04	PK20TR11	3253	1.1	K20TT	IK20TT	IK20TT	4
1.8 16V T.SPARK (932A3)	106	AR32201	10 mm diameter+	09/97-10/00	IU22	5361	0.9	-	-	-	4
1.8 16V T.SPARK (932A3)	106	AR32201	14 mm diameter+	09/97-10/00	PK20TR11	3253	1.1	K20TT	IK20TT	IK20TT	4
1.8 16V T.SPARK (932A31_)	103	AR32205	10 mm diameter+	10/00-09/05	IU22	5361	0.9	-	-	-	4
1.8 16V T.SPARK (932A31_)	103	AR32205	14 mm diameter+	10/00-09/05	PK20TR11	3253	1.1	K20TT	IK20TT	IK20TT	4
1.8 16V T.SPARK (932B31_)	103	AR32205	10 mm diameter+	10/00-05/06	IU22	5361	0.9	-	-	-	4
1.8 16V T.SPARK (932B31_)	103	AR32205	14 mm diameter+	10/00-05/06	PK20TR11	3253	1.1	K20TT	IK20TT	IK20TT	4
1.9 JTD	93/100/110	192 B1.000; 937 A4.000; 937 A5.000		11/02-09/05	DG-170		11V				4
1.9 JTD (932A2B, 932A2C)	85	937 A2.000		05/01-09/05	DG-122		11V				4
1.9 JTD (932A2B_)	81	AR 37101		10/00-05/01	DG-122		11V				4
1.9 JTD (932B2)	77	AR 32302		09/97-10/00	DG-127		11V				4
1.9 JTD (932B2B, 932B2C)	85	937 A2.000		05/01-05/06	DG-122		11V				4
1.9 JTD (932B2B_)	81	AR 37101		10/00-05/01	DG-122		11V				4
1.9 JTD 16V	103	192 A5.000		11/02-05/06	DG-170		11V				4
1.9 JTD 16V Q4	110	937 A5.000		07/04-05/06	DG-170		11V				4
2.0	119	932A2.000		04/03-05/06	PK20TR11	3253	1.1	K20TT	IK20TT	IK20TT	4

KW	KW	KW	NOTE	21	Standard			Twin Tip			QTY
					Standard	Standard	Standard	Twin Tip	Twin Tip	Twin Tip	
ALFA ROMEO <i>continued</i>											
156 (97-06) <i>continued</i>											
2.0 16V T.SPARK (932A2)	114	AR32301	10 mm diameter+	09/97-06/02	IJ22	5361	0.9	-	-	-	4
2.0 16V T.SPARK (932A2)	114	AR32301	14 mm diameter+	09/97-06/02	PK20TR11	3253	1.1	K20TT	IK20TT	IK20TT	4
2.0 16V T.SPARK (932A21_)	110	AR32310	10 mm diameter+	10/00-03/02	IJ22	5361	0.9	-	-	-	4
2.0 16V T.SPARK (932A21_)	110	AR32310	14 mm diameter+	10/00-03/02	PK20TR11	3253	1.1	K20TT	IK20TT	IK20TT	4
2.0 16V T.SPARK (932B21_)	110	AR32310	10 mm diameter+	10/00-03/02	IJ22	5361	0.9	-	-	-	4
2.0 16V T.SPARK (932B21_)	110	AR32310	14 mm diameter+	10/00-03/02	PK20TR11	3253	1.1	K20TT	IK20TT	IK20TT	4
2.0 JTS (932AXA)	122	932A2.000;937A1.00		03/02-09/05	PK20TR11	3253	1.1	K20TT	IK20TT	IK20TT	4
2.0 JTS (932BXA)	122	932A2.000;937A1.00		03/02-05/06	PK20TR11	3253	1.1	K20TT	IK20TT	IK20TT	4
2.4 JTD	129	841 G.000		10/03-05/06	DG-122		11V				5
2.4 JTD (932A1B_)	103	839 A6.000		10/00-09/05	DG-122		11V				5
2.4 JTD (932AXC)	110	841 C000		03/02-09/05	DG-122		11V				5
2.4 JTD (932B1)	100	AR 32501		11/99-09/03	DG-122		11V				5
2.4 JTD (932B1)	100	AR 32501		09/97-09/03	DG-127		11V				5
2.4 JTD (932B1B_)	103	839 A6.000		10/00-05/06	DG-122		11V				5
2.4 JTD (932BXC)	110	841 C000		03/02-05/06	DG-122		11V				5
2.5 V6 24V (932A1)	140	AR 32401; AR 32402		09/97-08/03	K20PBR-S10	5061	1.0	K20TT	IK20TT	IK20TT	6
2.5 V6 24V (932A11_)	141	AR 32405		10/00-03/03	K20PBR-S10	5061	1.0	K20TT	IK20TT	IK20TT	6
2.5 V6 24V (932A11_)	141	AR 32405		04/03-09/05	PK20PR-P8	3245	0.8	-	IK20TT	IK20TT	6
2.5 V6 24V (932B11_)	141	AR 32405		10/00-03/03	K20PBR-S10	5061	1.0	K20TT	IK20TT	IK20TT	6
2.5 V6 24V (932B11_)	141	AR 32405		04/03-05/06	PK20PR-P8	3245	0.8	-	IK20TT	IK20TT	6
3.2 GTA (932AXB)	184	932A.000		03/02-03/03	PK20PR-P8	3245	0.8	-	IK20TT	IK20TT	6
3.2 GTA (932AXB)	184	932A.000		04/03-09/05	PK20TR11	3253	1.1	K20TT	IK20TT	IK20TT	6
3.2 GTA (932BXB)	184	932A.000		03/02-03/03	PK20PR-P8	3245	0.8	-	IK20TT	IK20TT	6
3.2 GTA (932BXB)	184	932A.000		04/03-05/06	PK20TR11	3253	1.1	K20TT	IK20TT	IK20TT	6
159 (05-11)											
1.8 MPI	103	939 A4.000		03/07-02/08	KJ16CR-L11	3132	1.1	K16TT	IK16TT	IK16TT	4
1.9 JTDM 16V	100/110	937 A8.000; 939 A2.000		09/05-11/11	DG-170		11V				4
1.9 JTDM 8V	88	939 A1.000		09/05-11/11	DG-122		11V				4
1.9 JTDM 8V	85/88	937 A7.000; 939 A1.000; 939A7.000		03/06-02/08	DG-127		11V				4
1.9 JTDM 8V	85/88	937 A7.000; 939 A1.000; 939 A7.000		02/08-06/10	DG-170		11V				4
1.9 JTS	118	939A6.000		09/05-02/09	IK16	5303	1.1	-	IK16TT	IK16TT	4
2.0 JTDM	100/120/125	844 A2.000; 939 B3.000; 939 B4.000		05/09-11/11	DG-608		4.4V				4
2.2 JTS	136	939A5.000		09/05-11/11	IK16	5303	1.1	-	IK16TT	IK16TT	4
2.4 JTDM	147/154	939 A3.000; 939 A9.000		03/06-11/11	DG-170		11V				5
2.4 JTDM Q4	154	939 A9.000		05/07-11/11	DG-170		11V				5
3.2 JTS	191	939A.000		02/08-11/11	PT16VR13	5068	1.3	TV16TT	ITV16TT	ITV16TT	6
3.2 JTS Q4	191	939A.000		12/05-02/08	PK20TR11	3253	1.1	K20TT	IK20TT	IK20TT	6
3.2 JTS Q4	191	939A.000		02/08-11/11	PT16VR13	5068	1.3	TV16TT	ITV16TT	ITV16TT	6
164 (87-98)											
2.0	105	AR06416		10/90-10/92	K20PBR	5060	0.85	K20TT	IK20TT	IK20TT	4
2.0 T.S. (164.A2H)	109	AR06420	14 mm diameter+	06/87-12/90	K20PBR	5060	0.85	K20TT	IK20TT	IK20TT	4
2.0 T.S. (164.H3)	106	AR64103	14 mm diameter+	09/92-09/98	K20PBR	5060	0.85	K20TT	IK20TT	IK20TT	4
2.0 Turbo	128/129	AR 06476; AR06476		10/87-09/98	W20EPB	5065	0.85	W20TT	IW20TT	IW20TT	4
2.0 V6 Turbo (164.A2G, 164.A2F)	150	AR64101;AR64102		03/91-09/92	W22EPR-U	3088	0.8	W22TT	-	VW22	6
2.0 V6 Turbo (164.K3)	148	AR64102		09/92-09/98	W22EPR-U	3088	0.8	W22TT	-	VW22	6
2.5 TD (164.A1A)	84	VM 84 A		06/87-09/92	DG-202		11V				4
2.5 TD (164.K2A, 164.K2B)	92	VM 08 B; VM 32 B		09/92-04/95	DG-001		11V				4
2.5 TD (164.K2A, 164.K2B)	92	VM 08 B; VM 32 B		05/95-09/98	DG-109		11V				4
3.0 24V (164.K1)	155	AR64306;AR66301; AR66302		09/92-09/98	PK20PR-P8	3245	0.8	-	IK20TT	IK20TT	6
3.0 24V Q4 (164.K1M, 164.K1C)	170	AR64307;AR64308; AR66304		02/94-09/98	PK20PR-P8	3245	0.8	-	IK20TT	IK20TT	6
3.0 24V QV (164.H1)	171	AR64304		09/92-09/98	PK20PR-P8	3245	0.8	-	IK20TT	IK20TT	6
3.0 i.e. QV (164.AG)	147	AR64301		09/90-09/92	W22EPR-U	3088	0.8	W22TT	-	VW22	6
3.0 V6 (164.A)	141	AR06410		06/87-09/92	W22EPR-U	3088	0.8	W22TT	-	VW22	6

	KW					Standard			Twin Tip			QTY
ALFA ROMEO <i>continued</i>												
164 (87-98) <i>continued</i>												
3.0 V6 (164.AD, 164.AH, 164.AB)	135	AR06412		06/87-09/92	W22EPR-U	3088	0.8	W22TT	-		VW22	6
3.0 V6 (164.H1A, 164.H1B, 164.K1P)	132	AR64305;AR66303		09/92-09/98	W22EPR-U	3088	0.8	W22TT	-		VW22	6
166 (98-07)												
2.0 T.Spark (936A3A__)	114	AR34103	10 mm diameter+	09/98-10/00	IU22	5361	0.9	-	-	-		4
2.0 T.Spark (936A3A__)	114	AR34103	14 mm diameter+	09/98-10/00	PK20TR11	3253	1.1	K20TT	IK20TT	IK20TT		4
2.0 T.Spark (936A3B__)	110	AR36301	10 mm diameter+	10/00-04/06	IU22	5361	0.9	-	-	-		4
2.0 T.Spark (936A3B__)	110	AR36301	14 mm diameter+	10/00-04/06	PK20TR11	3253	1.1	K20TT	IK20TT	IK20TT		4
2.0 V6 (936A3__)	151	AR34102		09/98-10/00	W22EPR-U	3088	0.8	W22TT	-		VW22	6
2.4 JTD	110	841 C000		04/02-06/07	DG-122		11V					5
2.4 JTD	129/136	841 G.000; 841 H.000; 936 B.000		10/03-06/07	DG-170		11V					5
2.4 JTD (936A2A__)	100	AR 34202		09/98-10/00	DG-127		11V					5
2.4 JTD (936A2B__)	103	839 A6.000		10/00-06/07	DG-122		11V					5
2.5 V6 24V (936A2__)	140	AR34201		09/98-10/00	PK20PR-P8	3245	0.8	-	IK20TT	IK20TT		6
2.5 V6 24V (936A21__)	138	AR36201		10/00-01/05	PK20PR-P8	3245	0.8	-	IK20TT	IK20TT		6
3.0 V6 24V (936A1__)	166	AR34301;AR34302		09/98-10/00	PK20PR-P8	3245	0.8	-	IK20TT	IK20TT		6
3.0 V6 24V (936A11__)	162	AR36101		10/00-01/06	PK20PR-P8	3245	0.8	-	IK20TT	IK20TT		6
3.2 V6 24V	176	936A6.000		10/03-06/07	PK20PR-P8	3245	0.8	-	IK20TT	IK20TT		6
1750-2000 (68-75)												
2000 (105)	97	AR 10520		10/71-07/75	W20EPR-U	3047	0.8	W20TT	IW20TT	IW20TT		4
ALFASUD (72-89)												
1.2	46	AS30102;AS30110		01/78-01/79	W22EPR-U	3088	0.8	W22TT	-		VW22	4
1.2 (901.D0, 901.D1)	46	AS30100;AS30102		06/72-09/84	W22EPR-U	3088	0.8	W22TT	-		VW22	4
1.2 ti	50	AS30104;AS30110; AS30111		11/73-09/84	W22EPR-U	3088	0.8	W22TT	-		VW22	4
1.3	48/51	AS30160; AS30180		01/78-12/81	W22EPR-U	3088	0.8	W22TT	-		VW22	4
1.3 (901.F0)	50	AS30180		01/78-02/80	W22EPR-U	3088	0.8	W22TT	-		VW22	4
1.3 (902.A0)	55	AS30184		09/76-07/79	W22EPR-U	3088	0.8	W22TT	-		VW22	4
1.3 SC/ti Super	55	AS30156;AS30164		09/77-09/84	W22EPR-U	3088	0.8	W22TT	-		VW22	4
1.3 Super (901.F2)	51	AS30160		01/79-03/80	W22EPR-U	3088	0.8	W22TT	-		VW22	4
1.3 ti (901.G0)	55	AS30184;AS30190		09/77-03/79	W22EPR-U	3088	0.8	W22TT	-		VW22	4
1.3 ti (901.G4)	63	AS30168		03/80-12/84	W22EPR-U	3088	0.8	W22TT	-		VW22	4
1.4	55/63	AS30164; AS30168		05/78-12/89	W22EPR-U	3088	0.8	W22TT	-		VW22	4
1.5	77	AR30146;AR30182		01/83-12/87	W22EPR-U	3088	0.8	W22TT	-		VW22	4
1.5 (902.A1)	61	AS30124		06/79-03/80	W22EPR-U	3088	0.8	W22TT	-		VW22	4
1.5 (902.A5)	70	AR30198;AR30520; AS30126, AS30128, AS30133		07/79-01/87	W22EPR-U	3088	0.8	W22TT	-		VW22	4
1.5 ti	70	AS30126;AS30128; AS30133		03/80-12/84	W22EPR-U	3088	0.8	W22TT	-		VW22	4
1.5 ti (901.F1, 901.F4, 901.G1)	61	AS30124;AS30126		01/79-09/84	W22EPR-U	3088	0.8	W22TT	-		VW22	4
1.5 ti Sprint	77	AS30146;AS30198		01/83-12/84	W22EPR-U	3088	0.8	W22TT	-		VW22	4
1.7	87	AR30550		04/88-12/89	W22EPR-U	3088	0.8	W22TT	-		VW22	4
1.7 i.e.	77	AR30558		10/87-12/89	W22EPR-U	3088	0.8	W22TT	-		VW22	4
ALFETTA (74-84)												
1.6 (116.B1A)	79	AR01600		01/75-12/84	W22EPR-U	3088	0.8	W22TT	-		VW22	4
1.8	85/89	AR01608; AR01678		07/74-01/82	W22EPR-U	3088	0.8	W22TT	-		VW22	4
1.8 (116.B2)	90	AR01678		07/81-12/84	W22EPR-U	3088	0.8	W22TT	-		VW22	4
2.0 (116.55F, 116.56F, 116.55N, 116.56N)	97	AR01334;AR01655; AR01674, AR01713		07/78-12/84	W22EPR-U	3088	0.8	W22TT	-		VW22	4
2.0 (116.55G, 116.56G)	89	AR01605;AR01615; AR01623		03/77-02/80	W22EPR-U	3088	0.8	W22TT	-		VW22	4
2.0 TD (116.BA)	60	VM4HT/2		10/79-03/83	DG-202		11V					4
2.4 TD (116.B3)	70	VM4HT 2.4		04/83-12/84	DG-202		11V					4
ALFETTA GT (74-86)												
1.6	79	AR01600		01/76-02/80	W22EPR-U	3088	0.8	W22TT	-		VW22	4
1.8	85	AR01608		01/74-12/76	W22EPR-U	3088	0.8	W22TT	-		VW22	4
2.0	89/96	AR01623; AR01655		06/77-01/86	W22EPR-U	3088	0.8	W22TT	-		VW22	4
AR 6 (79-89)												
1.9 D	51	160 D100		04/85-12/89	DG-001		11V					4
2.0	99	AR01932		07/81-01/84	W22EPR-U	3088	0.8	W22TT	-		VW22	6
2.5 D	55	8144.67.220		03/86-12/89	DG-001		11V					4
2.5 i.e.	116	AR01913		04/79-06/84	W22EPR-U	3088	0.8	W22TT	-		VW22	6
2.5 i.e. (119.AA, 119.AB)	110	AR01928		10/83-12/86	W22EPR-U	3088	0.8	W22TT	-		VW22	6



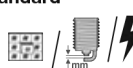



	KW				Standard			Twin Tip				QTY
ALFA ROMEO <i>continued</i>												
AR 6 (79-89) <i>continued</i>												
2.5 TD	77	VM-HR 588 HT		07/81-05/86	DG-202		11V					5
AR 8 (78-89)												
2.4 D	53	8140.61.200		04/78-08/86	DG-001		11V					4
2.5 D	55	8144.67.220		09/86-12/89	DG-001		11V					4
ARNA (83-86)												
1.2	46	AR31000		03/83-12/84	W22EPR-U	3088	0.8	W22TT	-	VW22		4
1.2 (920.AA)	44	AR30500		01/85-12/86	W22EPR-U	3088	0.8	W22TT	-	VW22		4
1.2 (920.AB, 920.AC)	50	AR30500		01/85-12/86	W22EPR-U	3088	0.8	W22TT	-	VW22		4
1.3	58	AR31006		01/85-12/86	W22EPR-U	3088	0.8	W22TT	-	VW22		4
1.3 TI (920.A1B)	63	AR30512;AR31010		03/83-12/86	W22EPR-U	3088	0.8	W22TT	-	VW22		4
1.5	70	AR31124		01/85-12/86	W22EPR-U	3088	0.8	W22TT	-	VW22		4
BRERA (06-)												
2.0 JTDM	120/ 125	844 A2.000; 939 B3.000		03/08-	DG-608		4.4V					4
2.2 JTS	136	939A5.000		01/06-10/10	IK16	5303	1.1	-	IK16TT	IK16TT		4
2.4 JTDM 20V	147/ 154	939 A3.000; 939 A9.000		01/06-	DG-170		11V					5
3.2 JTS	191	939A.000		03/08-10/10	PT16VR13	5068	1.3	TV16TT	ITV16TT	ITV16TT		6
3.2 JTS Q4	191	939A.000		01/06-10/10	PT16VR13	5068	1.3	TV16TT	ITV16TT	ITV16TT		6
GIULIA (62-78)												
1300 Super	64	ALFA06		01/74-12/78	W20EPR-U	3047	0.8	W20TT	IW20TT	IW20TT		4
1300 Super (115)	64	AR00530		01/74-12/78	W20EPR-U	3047	0.8	W20TT	IW20TT	IW20TT		4
1600 Super (105,14)	71	105.26		06/64-08/69	W22EPR-U	3088	0.8	W22TT	-	VW22		4
1600 Super (115)	76	AR00526		01/74-12/78	W20EPR-U	3047	0.8	W20TT	IW20TT	IW20TT		4
GIULIETTA (77-85)												
1.3 (116.44A)	66	AR01644		10/77-06/83	W22EPR-U	3088	0.8	W22TT	-	VW22		4
1.6 (116.50B)	79	AR01600		10/77-04/85	W22EPR-U	3088	0.8	W22TT	-	VW22		4
1.8 (116.AA, 116.AB)	90	AR01678		04/79-04/85	W22EPR-U	3088	0.8	W22TT	-	VW22		4
2.0 (116.A1A)	96	AR01655		06/80-04/85	W22EPR-U	3088	0.8	W22TT	-	VW22		4
2.0 TD	61	VM 4 HT		01/83-12/85	DG-198		11V					4
2.0 TD	61	VM 4 HT		01/83-12/85	DG-202		11V					4
2.0 Turbo	125	AR 01699		07/83-06/84	W22ESR-U	3098	0.8	-	-	-		4
GIULIETTA (10-)												
1.4 BiFuel	88	198A4.000		12/11-	IXU27	5337	0.9	-	-	-		4
1.4 TB	77/ 85/ 88/ 110/ 120/ 125	198A4.000; 940 B8.000; 940A2.000; 940A6.000; 955A8.000		04/10-	IXU27	5337	0.9	-	-	-		4
1.6 JTDM	77	940 A3.000		04/10-	DG-608		4.4V					4
2.0 JTDM	100/ 103/ 110/ 120/ 125	940 A4.000; 940 A5.000; 940 A7.000; 940 A8.000; 940 B5.000; 940 B6.000		04/10-	DG-608		4.4V					4
GT (63-77)												
1300 Junior (105)	64	ALFA06		01/66-12/77	W20EPR-U	3047	0.8	W20TT	IW20TT	IW20TT		4
1600 (115)	76	AR00526		09/72-12/77	W22EPR-U	3088	0.8	W22TT	-	VW22		4
V 2000 (105)	96	AR 10527		01/71-12/77	W20EPR-U	3047	0.8	W20TT	IW20TT	IW20TT		4
GT (03-10)												
1.8 TS	103	AR32205	10 mm diameter+	11/03-09/10	IJ22	5361	0.9	-	-	-		4
1.8 TS	103	AR32205	14 mm diameter+	11/03-09/10	PK20TR11	3253	1.1	K20TT	IK20TT	IK20TT		4
1.9 JTD	110/ 125	937 A5.000; 937 A6.000		11/03-09/10	DG-170		11V					4
2.0 JTS	119/ 121	932 A2.000; 932A2.000; 937A1.00		11/03-09/10	PK20TR11	3253	1.1	K20TT	IK20TT	IK20TT		4
3.2 GTA	176	936A6.000		11/03-01/08	PK20PR-P8	3245	0.8	-	IK20TT	IK20TT		6
GTV (78-87)												
2.0	96	AR01655		12/80-01/86	W22EPR-U	3088	0.8	W22TT	-	VW22		4
2.0 (116.36 E)	94	AR06212		01/85-12/85	W22EPR-U	3088	0.8	W22TT	-	VW22		4
6.2.5 (116.CA)	116	AR01646;AR01911		11/80-02/87	W22EPR-U	3088	0.8	W22TT	-	VW22		6
GTV (95-05)												
1.8 16V (916C3)	106	AR32201	10 mm diameter+	05/98-02/03	IJ22	5361	0.9	-	-	-		4
1.8 16V (916C3)	106	AR32201	14 mm diameter+	05/98-02/03	PK20TR11	3253	1.1	K20TT	IK20TT	IK20TT		4
2.0 JTS	121	937A1.000;AR32310	10 mm diameter+	04/03-10/05	IJ22	5361	0.9	-	-	-		4
2.0 JTS	121	937A1.000;AR32310	14 mm diameter+	04/03-10/05	PK20TR11	3253	1.1	K20TT	IK20TT	IK20TT		4

	KW					Standard		Twin Tip		QTY
ALFA ROMEO <i>continued</i>										
GTV (95-05) <i>continued</i>										
2.0 T.SPARK 16V (916.C2_, 916C2C00)	110	AR16201;AR32310	10 mm diameter+	06/95-02/03	IU22	5361	0.9	-	-	4
2.0 T.SPARK 16V (916.C2_, 916C2C00)	110	AR16201;AR32310	14 mm diameter+	06/95-02/03	PK20TR11	3253	1.1	K20TT	IK20TT	4
2.0 T.SPARK 16V (916C2C)	114	AR32301	10 mm diameter+	05/98-08/00	IU22	5361	0.9	-	-	4
2.0 T.SPARK 16V (916C2C)	114	AR32301	14 mm diameter+	05/98-08/00	PK20TR11	3253	1.1	K20TT	IK20TT	4
2.0 V6 Turbo (916.C2A)	148	AR16202		06/95-09/98	W22EPR-U	3088	0.8	W22TT	-	6
3.0 V6 24V (916.C1)	162	AR16102		10/96-10/00	PK20PR-P8	3245	0.8	-	IK20TT	6
3.0 V6 24V (916.C1B_)	160	AR16105		10/00-02/03	PK20PR-P8	3245	0.8	-	IK20TT	6
3.2 V6 24V	176	936A6.000		04/03-10/05	PK20PR-P8	3245	0.8	-	IK20TT	6
MITO (08-)										
1.3 MultiJet	66	199 A3.000		09/08-	DG-171		11V			4
1.3 MultiJet	59/62/70	199 B1.000; 199 B4.000; 199 B8.000		10/09-	DG-621		4.4V			4
1.4	51/57/58/70	199 A6.000; 350 A1.000; 955 A1.000; 955 A9.000		09/08-	XU22EPR-U	3179	0.9	XU22TT	-	4
1.4 Bifuel	88	198 A4.000	LPG / GPL	07/11-	IXU27	5337	0.9	-	-	4
1.4 MultiAir	77	955 A6.000		08/10-	XU22EPR-U	3179	0.9	XU22TT	-	4
1.4 TB	103	198A4.000		12/13-	IXU27	5337	0.9	-	-	4
1.4 TJet	88/110/114	198 A1.000; 198 A4.000; 199 A8.000		09/08-	IXU27	5337	0.9	-	-	4
1.4 Turbo MultiAir	99/120/125	940 A2.000; 955 A2.000; 955 A7.000; 955 A8.000		10/09-	IXU27	5337	0.9	-	-	4
1.6 JTDM	85/88	198 A2.000; 955 A3.000; 955 A4.000		09/08-	DG-608		4.4V			4
RZ (92-94)										
3.0 V6 Zagato	152	AR61501		01/92-12/94	W22EPR-U	3088	0.8	W22TT	-	6
SPIDER (66-77)										
2000	96	AR00512		07/74-12/77	W22EPR-U	3088	0.8	W22TT	-	4
SPIDER (71-93)										
1600	76/79	AR00526A; AR01563		06/80-12/93	W22EPR-U	3088	0.8	W22TT	-	4
2000	85/88/92	AR00515; AR01544; AR01588		08/86-12/90	W22EPR-U	3088	0.8	W22TT	-	4
2000 Veloce	93	AR00515; AR01590		01/77-12/93	W22EPR-U	3088	0.8	W22TT	-	4
SPIDER (94-05)										
1.8 16V (916S3)	106	AR32201	10 mm diameter+	05/98-10/00	IU22	5361	0.9	-	-	4
1.8 16V (916S3)	106	AR32201	14 mm diameter+	05/98-10/00	PK20TR11	3253	1.1	K20TT	IK20TT	4
2.0 JTS	121	937 A1.000		04/03-04/05	PK20TR11	3253	1.1	K20TT	IK20TT	4
2.0 T.SPARK 16V (916S2B)	114	AR 32301	10 mm diameter+	05/98-08/00	IU22	5361	0.9	-	-	4
2.0 T.SPARK 16V (916S2B)	114	AR 32301	14 mm diameter+	05/98-08/00	PK20TR11	3253	1.1	K20TT	IK20TT	4
2.0 T.SPARK 16V (916S2C00)	110	AR 16201; AR 32310	10 mm diameter+	06/95-04/05	IU22	5361	0.9	-	-	4
2.0 T.SPARK 16V (916S2C00)	110	AR 16201; AR 32310	14 mm diameter+	06/95-04/05	PK20TR11	3253	1.1	K20TT	IK20TT	4
2.0 V6 Turbo (916S2A)	148	AR 16202		05/98-02/03	W22EPR-U	3088	0.8	W22TT	-	6
3.0 V6 (916S1)	141	AR16101;AR16199		06/95-02/03	W22EPR-U	3088	0.8	W22TT	-	6
3.0 V6 (916S1B00)	160	AR16105		09/94-08/00	PK20PR-P8	3245	0.8	-	IK20TT	6
3.2 V6 24V	176	936A6.000		04/03-04/05	PK20PR-P8	3245	0.8	-	IK20TT	6
SPIDER (06-)										
2.0 JTDM	120/125	844 A2.000; 939 B3.000		04/09-	DG-608		4.4V			4
2.2 JTS	136	939A5.000		09/06-09/10	IK16	5303	1.1	-	IK16TT	4
2.4 JTDM	147/154	939 A3.000		04/07-09/10	DG-170		11V			5
3.2 JTS	191	939A.000		03/08-09/10	PT16VR13	5068	1.3	TV16TT	ITV16TT	6
3.2 JTS Q4	191	939A.000		09/06-09/10	PT16VR13	5068	1.3	TV16TT	ITV16TT	6
SZ (88-94)										
3.0 V6 Zagato	152	AR61501		09/88-12/91	W22EPR-U	3088	0.8	W22TT	-	6
ALPINA										
B3 (E36) (93-99)										
3.2	195	M60 B30 (308S); M60 B30 (308S6K)		04/96-03/99	K20TXR	5063	1.0	K20TT	IK20TT	6

	KW								QTY
ALPINA <i>continued</i>									
B3 (E46) (99-06)									
3.3	206	M52 B28 (286S); M52 B28 (286S7T)		02/00-07/02	K20TXR	5063 1.0	K20TT IK20TT	IK20TT	6
3.3 All-wheel Drive	206	M52 B28 (286S7T)		11/01-01/05	K20TXR	5063 1.0	K20TT IK20TT	IK20TT	6
3.4 S	224	M52 B28 (286S7T)		08/02-01/06	K20TXR	5063 1.0	K20TT IK20TT	IK20TT	6
B5 (E60, E61) (05-)									
4.4	368	N62B44A19		03/05-	PK22PR8	3273 0.8	-	- VK22	8
B7 (E65) (03-08)									
4.4	368	N62B44A19		12/03-06/08	PK22PR8	3273 0.8	-	- VK22	8
B8 (E36) (95-98)									
4.6	245	M62 B46 (468S4K)		01/95-03/98	K20TXR	5063 1.0	K20TT IK20TT	IK20TT	8
B9 (E24) (82-85)									
3.5	180	M30 B30 (306EA2)		07/82-12/85	W20EP-U	3043 0.8	W20TT IW20TT	IW20TT	6
B9 (E28) (81-85)									
3.0	180	M30 B30 (306EA2)		11/81-12/85	W20EP-U	3043 0.8	W20TT IW20TT	IW20TT	6
B10 (E34) (88-96)									
3.5	187	M30 B34 (34C20)		04/88-12/92	W20EP-U	3043 0.8	W20TT IW20TT	IW20TT	6
B10 (E39) (96-04)									
3.2	191	M60 B30 (308S6K)		08/97-12/98	K20TXR	5063 1.0	K20TT IK20TT	IK20TT	8
3.3	206	M52 B28 (286S7T)		01/99-10/03	K20TXR	5063 1.0	K20TT IK20TT	IK20TT	6
4.6 V8	250/255	M62 B46 (468S72)		01/97-09/02	K20TXR	5063 1.0	K20TT IK20TT	IK20TT	8
B12 (E31) (90-96)									
5.0	258	M70 B50 (5012KA)		06/90-05/94	K20R-U	3122 0.8	K20TT IK20TT	IK20TT	12
B12 (E38) (95-01)									
5.7	285	M70 B57 (5714K2)		12/95-09/98	K20TXR	5063 1.0	K20TT IK20TT	IK20TT	12
6.0	316	M73 B54 (5412AG)		07/99-07/01	K20TXR	5063 1.0	K20TT IK20TT	IK20TT	12
D3 (E91) (05-)									
2.0	157	N47 D20 C		07/10-	DG-178	5V			4
D10 (E39) (00-03)									
3.0 D Biturbo	180	M57 D30 (306DE1)		04/00-10/03	DG-145	11V			6
ROADSTER (Z8) (02-03)									
4.8 V8	280	M73 B48 (488S12)		06/02-10/03	K20TXR	5063 1.0	K20TT IK20TT	IK20TT	8
ROADSTER S (Z4) (03-05)									
3.3	221	S54327S7		07/03-12/05	K20TXR	5063 1.0	K20TT IK20TT	IK20TT	6
ALPINE									
1600 (69-75)									
1.6 SC-SI	93			01/73-12/75	IW27	5317 0.7	-	-	4
A310 (71-84)									
2.7 V6	110			01/76-12/84	T20EPR-U	5032 0.8	T20TT IT20TT	IT20TT	6
A610 (91-95)									
3.0 TURBO	184			01/91-04/95	K22PB	5069 0.85	-	- VK22	6
V6 (85-90)									
2.5 TURBO	136	Z7U-734		01/85-12/90	IT22	5327 0.8	-	-	6
2.5 TURBO	147	Z7U		01/88-12/90	T22EP-U	5040 0.8	-	-	6
2.9 GT	116	Z6W		01/85-12/90	T22EP-U	5040 0.8	-	-	6
ARO									
10 (80-06)									
1,3	40	810-02		06/80-11/86	W16EPR-U	3021 0.8	W16TT IW16TT	IW16TT	4
1,4	46	IAP 810-R-99		06/84-10/99	W16EPR-U	3021 0.8	W16TT IW16TT	IW16TT	4
1.6 D	40	F8M 700		09/86-10/99	DG-001	11V			4
1.9 D	48	F8QA6		09/92-10/06	DG-001	11V			4
1.9 TD	69	F8QT		06/97-10/06	DG-012	11V			4
240-244 (78-06)									
2.5	60	Aro L25		01/80-12/98	W22FPR-U	4022 0.7	-	-	4
2.5 D	52	XD3P		01/83-12/98	DG-001	11V			4
2.5 TD	70/74	VM-425HLT; XD3TP		01/92-12/06	DG-001	11V			4
2.7 D	50/52/60	Aro L-27D		01/83-12/98	DG-001	11V			4
SPARTANA (99-06)									
1.2	40	C3G 702		01/99-10/06	W16EPR-U	3021 0.8	W16TT IW16TT	IW16TT	4
ASIA MOTORS									
ROCSTA (89-99)									
1.8 i 4x4	57	F804		06/93-12/99	W16EPR-U	3021 0.8	W16TT IW16TT	IW16TT	4
2.2 D 4x4	45	R2		06/93-12/99	DG-114	7V			4
ASTON MARTIN									
CYGNET (11-13)									
1.3	72	1NR-FE		04/11-10/13	SC20HR11	3444 1.1	-	IXEH22TT IXEH22TT	4

Spark & Glow Plugs

Application Tables









	KW					Standard		Twin Tip		QTY	
ASTON MARTIN <i>continued</i>											
DB6 (64-70)											
4.0	210/243	AJ6		10/64-12/70	W20EPR-U	3047	0.8	W20TT	IW20TT	IW20TT	6
DB7 (94-03)											
3.2	233/250	AJ6HT		05/94-10/03	Q22PR-U	3010	0.8	-	-	VQ22	6
5.9	298/309	AM2		03/99-10/03	PT16EPR-L13	5070	1.3	-	IT16TT	IT16TT	12
6.0	320	AM2		10/02-10/03	PT16EPR-L13	5070	1.3	-	IT16TT	IT16TT	12
DB9 (04-)											
6.0	331			04/04-07/12	ZT20EPR11	5087	1.1	T20TT	IT20TT	IT20TT	12
6.0 V12	331/350			01/04-	ZT20EPR11	5087	1.1	T20TT	IT20TT	IT20TT	12
DBS (66-72)											
4.0	210	AJ6		01/66-12/72	W20EPR-U	3047	0.8	W20TT	IW20TT	IW20TT	6
LAGONDA (76-97)											
5.3	228/250/262	40HCA; 40HEL; 40HES		01/76-12/97	W20EXR-U	3066	0.8	W20TT	IW20TT	IW20TT	8
V8 (69-93)											
5.3	376	40HE		01/69-12/89	IW22	5307	0.8	-	-	VW22	8
VANQUISH (01-07)											
6.0 V12	338	AM 702		09/01-08/07	ZT20EPR11	5087	1.1	T20TT	IT20TT	IT20TT	12
VIRAGE (87-92)											
5.3	246	40HTA; 40HTE		01/88-12/92	Q20PR-U	3007	0.8	Q20TT	IQ20TT	IQ20TT	8
VIRAGE (90-00)											
5.3	410	40HTE		10/92-10/00	IQ24	5314	0.8	-	-	-	8
5.3	246	40HTE		09/90-12/95	Q20PR-U	3007	0.8	Q20TT	IQ20TT	IQ20TT	8
ZAGATO (86-89)											
5.3	228/322	40HCD		01/86-12/89	W22EPR-U	3088	0.8	W22TT	-	VW22	8
AUDI											
50 (86) (74-78)											
1.1	37	HB		08/74-07/78	W20EP-U	3043	0.8	W20TT	IW20TT	IW20TT	4
1.3	44	HH		08/77-07/78	W20EP-U	3043	0.8	W20TT	IW20TT	IW20TT	4
80 (80, 82, B1) (72-78)											
1.3	44	ZF		05/72-07/78	W20EP-U	3043	0.8	W20TT	IW20TT	IW20TT	4
1.6	63	YP		09/75-07/78	W20EPB	5065	0.85	W20TT	IW20TT	IW20TT	4
1.6	53	FS;WP; YY		01/76-07/78	W20EPR-U	3047	0.8	W20TT	IW20TT	IW20TT	4
1.6	55	YN		09/75-07/78	W20EP-U	3043	0.8	W20TT	IW20TT	IW20TT	4
80 (81, 85, B2) (78-86)											
1.3	40/44	FY; FZ; ZA		09/78-07/81	W20EPR-U	3047	0.8	W20TT	IW20TT	IW20TT	4
1.3	44	EP	Ch: >F-220 000	08/81-07/86	W20EPR-U	3047	0.8	W20TT	IW20TT	IW20TT	4
1.3	44	EP	Ch: G-000 001>	08/85-07/86	W16EPB10	5064	1.0	W16TT	IW16TT	IW16TT	4
1.6	54	SA		02/86-07/86	IW16	5305	1.1	-	IW16TT	IW16TT	4
1.6	55	DT		08/85-07/86	W16EPB10	5064	1.0	W16TT	IW16TT	IW16TT	4
1.6	51/55	DT; WY; WZ; YN; YT; YY		08/78-07/83	W20EPR-U	3047	0.8	W20TT	IW20TT	IW20TT	4
1.6	63	YP		08/78-07/81	W20EP-U	3043	0.8	W20TT	IW20TT	IW20TT	4
1.6 D	40	CR; JK		08/80-08/86	DG-012		11V				4
1.6 GLE	81	YZ		01/79-07/81	W22EP-U	3085	0.8	W22TT	-	VW22	4
1.6 TD	51	CY		08/81-05/86	DG-012		11V				4
1.8	66	DS		01/83-08/86	W20EPB	5065	0.85	W20TT	IW20TT	IW20TT	4
1.8	65/68	JN; SF		08/83-08/86	W20EPBR-S	5067	0.85	W20TT	IW20TT	IW20TT	4
1.8 CC quattro (85Q)	66	NE		08/84-08/86	W20EPB	5065	0.85	W20TT	IW20TT	IW20TT	4
1.8 CC quattro (85Q)	68	JN		08/85-08/86	W20EPBR-S	5067	0.85	W20TT	IW20TT	IW20TT	4
1.8 GTE	81/82	DZ; PV		10/84-08/86	W20EPB	5065	0.85	W20TT	IW20TT	IW20TT	4
1.8 GTE quattro (85Q)	81/82	DZ; PV		08/84-08/86	W20EPB	5065	0.85	W20TT	IW20TT	IW20TT	4
1.9 CD-5S	85	WN		09/81-07/83	W22EP-U	3085	0.8	W22TT	-	VW22	5
2.0	85	JS		10/83-09/84	W20EPB	5065	0.85	W20TT	IW20TT	IW20TT	5
2.0 quattro (85Q)	85	JS		10/83-09/84	W20EPR-U	3047	0.8	W20TT	IW20TT	IW20TT	5
2.2	85	WE		10/80-07/81	W20EP-U	3043	0.8	W20TT	IW20TT	IW20TT	5
2.2 quattro	96	KL		08/82-07/84	W20EPR-U	3047	0.8	W20TT	IW20TT	IW20TT	5
2.2 quattro (85Q)	100	KK		08/82-07/84	W22EP-U	3085	0.8	W22TT	-	VW22	5
80 (89, 8A, B3) (86-91)											
1.4	48	SE		08/86-07/88	W16EPB10	5064	1.0	W16TT	IW16TT	IW16TT	4
1.6	55	RN		09/86-08/91	W16EPB10	5064	1.0	W16TT	IW16TT	IW16TT	4
1.6	75	ABB		08/90-10/91	W20EPB	5065	0.85	W20TT	IW20TT	IW20TT	4
1.6	51	PP		08/87-09/91	W20EPBR-S	5067	0.85	W20TT	IW20TT	IW20TT	4
1.6 D	40	JK		09/86-08/91	DG-012		11V				4







Spark & Glow Plugs







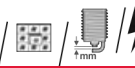

Application Tables







Application Tables

A

	KW									QTY	
AUDI <i>continued</i>											
80 (89, 8A, B3) (86-91) <i>continued</i>											
1.6 TD	59	RA; SB		09/86-08/91	DG-012		11V			4	
1.8	55/83	RU; SD		09/86-01/90	W20EPBR-S	5067	0.85	W20TT	IW20TT	IW20TT	4
1.8 E	82	DZ		06/86-08/91	W20EPB	5065	0.85	W20TT	IW20TT	IW20TT	4
1.8 E quattro	82	DZ		09/86-08/91	W20EPB	5065	0.85	W20TT	IW20TT	IW20TT	4
1.8 quattro	83	SD		09/86-08/90	W20EPBR-S	5067	0.85	W20TT	IW20TT	IW20TT	4
1.8 S	66	JN; NE; PM		09/86-10/91	W20EPB	5065	0.85	W20TT	IW20TT	IW20TT	4
1.8 S	65	SF		09/86-12/90	W20EPBR-S	5067	0.85	W20TT	IW20TT	IW20TT	4
1.8 S quattro	65/66	JN; NE; PM; SF		09/86-09/91	W20EPB	5065	0.85	W20TT	IW20TT	IW20TT	4
1.9 D	50	1Y		08/89-08/91	DG-012		11V			4	
2.0	82	AAD		10/90-08/91	W20EPB	5065	0.85	W20TT	IW20TT	IW20TT	4
2.0 E	83	3A		08/88-10/90	W20EPBR-S	5067	0.85	W20TT	IW20TT	IW20TT	4
2.0 E 16V	101	6A		03/90-09/91	K22PBR-S	5062	0.85	-	-	VK22	4
2.0 E 16V quattro	101	6A		03/90-08/91	K22PBR-S	5062	0.85	-	-	VK22	4
2.0 E quattro	83	3A		08/88-09/90	W20EPBR-S	5067	0.85	W20TT	IW20TT	IW20TT	4
2.0 quattro	85	AAD		10/90-08/91	W20EPB	5065	0.85	W20TT	IW20TT	IW20TT	4
80 (8C, B4) (91-96)											
1.6	52	ABM		09/91-12/94	W20EPBR-S	5067	0.85	W20TT	IW20TT	IW20TT	4
1.6 E	74	ADA		06/93-01/96	W20EPBR-S	5067	0.85	W20TT	IW20TT	IW20TT	4
1.9 TD	55	AAZ		09/91-12/94	DG-012		11V			4	
1.9 TDI	66	1Z		09/91-01/96	DG-005		11V			4	
2.0	66	ABT		09/91-01/96	W20EPBR-S	5067	0.85	W20TT	IW20TT	IW20TT	4
2.0 E	85	ABK		09/91-01/96	W20EPBR-S	5067	0.85	W20TT	IW20TT	IW20TT	4
2.0 E 16V	103	ACE		02/93-01/96	IK22	5310	0.8	-	-	VK22	4
2.0 E 16V	103	ACE		08/92-12/94	K22PBR-S	5062	0.85	-	-	VK22	4
2.0 E 16V quattro	103	ACE		04/92-07/95	K22PBR-S	5062	0.85	-	-	VK22	4
2.0 E quattro	85	ABK		09/91-12/94	W20EPBR-S	5067	0.85	W20TT	IW20TT	IW20TT	4
2.0 quattro	79	ADW		11/93-01/96	W20EPBR-S	5067	0.85	W20TT	IW20TT	IW20TT	4
2.3 E	98	NG		09/91-12/94	W16ETR-S	3285	1.0	W16TT	IW16TT	IW16TT	5
2.3 E	98	NG		07/92-01/96	W20EPBR-S	5067	0.85	W20TT	IW20TT	IW20TT	5
2.3 E quattro	98	NG		09/91-12/94	W16ETR-S	3285	1.0	W16TT	IW16TT	IW16TT	5
2.3 E quattro	98	NG		09/91-11/94	W20EPBR-S	5067	0.85	W20TT	IW20TT	IW20TT	5
2.6	110	ABC		07/92-01/96	K20PBR-S10	5061	1.0	K20TT	IK20TT	IK20TT	6
2.6 quattro	110	ABC		06/92-07/95	K20PBR-S10	5061	1.0	K20TT	IK20TT	IK20TT	6
2.8	128	AAH		09/91-01/96	K20PBR-S10	5061	1.0	K20TT	IK20TT	IK20TT	6
2.8 quattro	128	AAH		09/91-07/95	K20PBR-S10	5061	1.0	K20TT	IK20TT	IK20TT	6
RS2 quattro (P1)	232	ADU		03/94-05/95	PK22PR8	3273	0.8	-	-	VK22	5
S2 quattro	169	ABY		02/93-07/95	PK22PR8	3273	0.8	-	-	VK22	5
S2 quattro	169	ABY		02/93-12/94	PK22PR8	3273	0.8	-	-	VK22	5
90 (81, 85, B2) (84-87)											
2.0	83/85	JS; SK		10/84-03/87	W20EPB	5065	0.85	W20TT	IW20TT	IW20TT	5
2.0 quattro	85	JS		08/84-08/86	W20EPB	5065	0.85	W20TT	IW20TT	IW20TT	5
2.2	100	KV		10/84-03/87	W20EPB	5065	0.85	W20TT	IW20TT	IW20TT	5
2.2 E quattro	88/100	JT; KV		11/84-03/87	W20EPB	5065	0.85	W20TT	IW20TT	IW20TT	5
90 (89, 8A, B3) (87-91)											
1.6 TD	59	RA; SB		04/87-09/91	DG-012		11V			4	
2.0	85	PS		07/88-09/91	W20EPBR-S	5067	0.85	W20TT	IW20TT	IW20TT	5
2.0 20 V	118	NM		08/89-07/91	K22PB	5069	0.85	-	-	VK22	5
2.0 20 V quattro	118	NM		08/88-09/91	K22PB	5069	0.85	-	-	VK22	5
2.2 E	100	KV		04/87-07/91	W20EPB	5065	0.85	W20TT	IW20TT	IW20TT	5
2.2 E quattro	100	KV		04/87-09/91	W20EPB	5065	0.85	W20TT	IW20TT	IW20TT	5
2.3 E	98/100	NG		04/87-09/91	W16ETR-S	3285	1.0	W16TT	IW16TT	IW16TT	5
2.3 E 20V	125	7A		08/88-07/91	K22PBR-S	5062	0.85	-	-	VK22	5
2.3 E quattro	98/100	NG		04/87-09/91	W16ETR-S	3285	1.0	W16TT	IW16TT	IW16TT	5
100 (43, C2) (76-83)											
1.6	63	YV		08/76-07/82	W20EP-U	3043	0.8	W20TT	IW20TT	IW20TT	4
1.9	74	WH		08/80-07/82	W20EP-U	3043	0.8	W20TT	IW20TT	IW20TT	5
2.0	85	WA		06/76-07/80	W22EP-U	3085	0.8	W22TT	-	VW22	4
2.0 D	51	CN		08/78-02/83	DG-012		11V			5	
2.1	100	WG		03/77-02/83	W20EPB	5065	0.85	W20TT	IW20TT	IW20TT	5
2.1	85	WE		07/77-02/83	W20EP-U	3043	0.8	W20TT	IW20TT	IW20TT	5
100 (44, C3) (82-91)											
1.8	66	NP		08/83-07/89	W20EPB	5065	0.85	W20TT	IW20TT	IW20TT	4
1.8	65	SH		02/86-07/90	W20EPBR-S	5067	0.85	W20TT	IW20TT	IW20TT	4
1.8	55	DR; RS		08/82-12/87	W20EPR-U	3047	0.8	W20TT	IW20TT	IW20TT	4



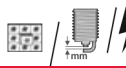



	KW								QTY		
AUDI <i>continued</i>											
100 (44, C3) (82-91) <i>continued</i>											
1.8	55	DR	Ch: H084706>K100 614	01/86-12/87	W16EPB10	5064	1.0	W16TT	IW16TT	IW16TT	4
1.8 CAT	66	4B		03/85-11/90	W20EPBR-S	5067	0.85	W20TT	IW20TT	IW20TT	4
1.8 quattro	66	NP		10/84-07/88	W20EPB	5065	0.85	W20TT	IW20TT	IW20TT	4
1.8 quattro	65	SH		08/86-07/90	W20EPBR-S	5067	0.85	W20TT	IW20TT	IW20TT	4
1.8 quattro CAT	66	4B		08/85-11/90	W20EPBR-S	5067	0.85	W20TT	IW20TT	IW20TT	4
1.9	74	WH		08/82-07/84	W20EP-U	3043	0.8	W20TT	IW20TT	IW20TT	5
2.0	83/85	KP; SL		08/86-12/87	W20EPB	5065	0.85	W20TT	IW20TT	IW20TT	5
2.0 CAT	85	RT		01/88-11/90	W20EPBR-S	5067	0.85	W20TT	IW20TT	IW20TT	5
2.0 D	51	CN		08/82-11/90	DG-012		11V				5
2.0 D Turbo	64/74	DE; NC		08/82-11/90	DG-012		11V				5
2.0 E	85	KP		08/86-12/87	W20EPB	5065	0.85	W20TT	IW20TT	IW20TT	5
2.0 E CAT	85	RT		01/88-11/90	W20EPBR-S	5067	0.85	W20TT	IW20TT	IW20TT	5
2.0 TD	64/74	DE; NC		03/83-11/90	DG-012		11V				5
2.1	100	WC		08/82-07/84	W20EPB	5065	0.85	W20TT	IW20TT	IW20TT	5
2.2	85/ 96/ 101	KF; KU; KZ		08/82-12/88	W20EPB	5065	0.85	W20TT	IW20TT	IW20TT	5
2.2	79	WU		08/82-07/84	W20EPR-U	3047	0.8	W20TT	IW20TT	IW20TT	5
2.2 CAT	101	KU		06/89-11/90	W20EPB	5065	0.85	W20TT	IW20TT	IW20TT	5
2.2 E Turbo quattro	121	MC		08/86-11/90	W20EPB	5065	0.85	W20TT	IW20TT	IW20TT	5
2.2 quattro	101	KU		08/84-12/88	W20EPB	5065	0.85	W20TT	IW20TT	IW20TT	5
2.2 Turbo	121	MC		08/86-11/90	W20EPB	5065	0.85	W20TT	IW20TT	IW20TT	5
2.2 Turbo quattro	121	MC		08/86-11/90	W20EPB	5065	0.85	W20TT	IW20TT	IW20TT	5
2.3	100	NF		08/86-11/90	W20EPB	5065	0.85	W20TT	IW20TT	IW20TT	5
2.3 E	98	NF		01/90-11/90	W16ETR-S	3285	1.0	W16TT	IW16TT	IW16TT	5
2.3 E	100	NF		10/86-11/90	W20EPB	5065	0.85	W20TT	IW20TT	IW20TT	5
2.3 E quattro	100	NF		08/86-11/90	W20EPB	5065	0.85	W20TT	IW20TT	IW20TT	5
2.4 D	60	3D		08/89-07/91	DG-012		11V				5
2.5 TDI	88	1T		01/90-11/90	DG-005		11V				5
100 (4A, C4) (90-94)											
2.0	74	AAE		12/90-06/94	W20EPBR-S	5067	0.85	W20TT	IW20TT	IW20TT	4
2.0 E	74/85	AAE; ABK		12/90-06/94	W20EPBR-S	5067	0.85	W20TT	IW20TT	IW20TT	4
2.0 E 16V	103	ACE		01/92-06/94	K22PBR-S	5062	0.85	-	-	VK22	4
2.0 E 16V quattro	103	ACE		07/92-06/94	K22PBR-S	5062	0.85	-	-	VK22	4
2.0 E quattro	85	AAD		12/90-07/92	W20EPB	5065	0.85	W20TT	IW20TT	IW20TT	4
2.3 E	98	AAR		12/90-06/94	W20EPBR-S	5067	0.85	W20TT	IW20TT	IW20TT	5
2.3 E quattro	98	AAR		12/90-06/94	W16ETR-S	3285	1.0	W16TT	IW16TT	IW16TT	5
2.4 D	60	AAS		12/90-06/94	DG-012		11V				5
2.5 TDI	85	AAT; ABP		12/90-06/94	DG-005		11V				5
2.6	102/ 110	ABC; ACZ		03/92-06/94	K20PBR-S10	5061	1.0	K20TT	IK20TT	IK20TT	6
2.6 E quattro	102	ACZ		08/93-07/94	K20PBR-S10	5061	1.0	K20TT	IK20TT	IK20TT	6
2.6 quattro	110	ABC		04/92-06/94	K20PBR-S10	5061	1.0	K20TT	IK20TT	IK20TT	6
2.8 E	128	AAH		12/90-06/94	K20PBR-S10	5061	1.0	K20TT	IK20TT	IK20TT	6
2.8 E quattro	128	AAH		12/90-06/94	K20PBR-S10	5061	1.0	K20TT	IK20TT	IK20TT	6
S4 Turbo quattro	169	AAN		08/91-06/94	PK22PR8	3273	0.8	-	-	VK22	5
S4 V8 quattro	206	ABH		10/92-06/94	T20EPR-U	5032	0.8	T20TT	IT20TT	IT20TT	8
100 (C1) (68-76)											
1.8	66	ZX		11/68-11/71	W20EPR-U	3047	0.8	W20TT	IW20TT	IW20TT	4
200 (43) (79-82)											
2.1 5E	100	WC		10/79-09/82	W20EPB	5065	0.85	W20TT	IW20TT	IW20TT	5
2.1 5T	125	WJ		10/79-08/82	IW22	5307	0.8	-	-	VW22	5
200 (44) (83-91)											
2.1 5E	100	WC		08/83-07/84	W20EPB	5065	0.85	W20TT	IW20TT	IW20TT	5
2.1 Turbo	134	KG		08/85-01/88	W20EPB	5065	0.85	W20TT	IW20TT	IW20TT	5
2.1 Turbo quattro	134	JY; KG		10/84-01/88	W20EPB	5065	0.85	W20TT	IW20TT	IW20TT	5
2.2	101	KU		08/84-07/85	W20EPB	5065	0.85	W20TT	IW20TT	IW20TT	5
2.2 20V Turbo quattro	162	3B		03/89-12/90	PK22PR8	3273	0.8	-	-	VK22	5
2.2 Turbo	121/ 140/ 147	1B; 2B; MC		08/85-09/91	W20EPB	5065	0.85	W20TT	IW20TT	IW20TT	5
2.2 Turbo quattro	121/ 147	1B; MC		01/85-12/91	W20EPB	5065	0.85	W20TT	IW20TT	IW20TT	5
2.3	100	NF		11/86-09/91	W20EPB	5065	0.85	W20TT	IW20TT	IW20TT	5
A1 (8X) (10-)											
1.4 TFSI	90	CAXA		05/10-	PKJ20CR8	3173	0.8	-	-	VK20G	4
1.6 TDI	66/77	CAYB; CAYC		03/11-	DG-193		4.4V				4







	KW								QTY	
AUDI <i>continued</i>										
A1 (8X) (10-) <i>continued</i>										
2.0 TDI	100/105	CFHB; CFHD		09/11-	DG-193		4.4V		4	
A2 (8Z) (00-05)										
1.2 TDI	45	ANY		03/01-08/05	DG-109		11V		3	
1.4	55	AUA; BBY		02/00-08/05	K20PBR-S10	5061	1.0	K20TT	IK20TT	4
1.4 TDI	55	AMF; BHC		02/00-08/05	DG-109		11V		3	
1.4 TDI	66	ATL		11/03-08/05	DG-177		5V		3	
1.6 FSI	81	BAD		05/02-08/05	K20PBR-S10	5061	1.0	K20TT	IK20TT	4
A3 (8L) (96-03)										
1.6	74/75	AEH; AVU		09/96-05/03	K20PBR-S10	5061	1.0	K20TT	IK20TT	4
1.8	92	AGN		09/96-05/03	K20PBR-S10	5061	1.0	K20TT	IK20TT	4
1.8 T	110/132	AGU; AUQ		12/96-05/03	PK20PR-P8	3245	0.8	-	IK20TT	4
1.8 T quattro	110/132	AQA; ARY		12/96-05/03	PK20PR-P8	3245	0.8	-	IK20TT	4
1.9 TDI	66/81	AGR; AHF; ALH; ASV		09/96-07/01	DG-005		11V		4	
1.9 TDI	74/96	ASZ; ATD; AXR	Ch: >8L-2-037 877	08/00-05/03	DG-005		11V		4	
1.9 TDI	74/96	ASZ; ATD; AXR	Ch: 8L-2-037 878>	08/00-05/03	DG-109		11V		4	
1.9 TDI quattro	96	ASZ	Ch: >8L-2-037 877	08/00-05/03	DG-005		11V		4	
1.9 TDI quattro	96	ASZ	Ch: 8L-2-037 878>	08/00-05/03	DG-109		11V		4	
S3 quattro	154/165	AMK; BAM		03/99-05/03	PK20PR-P8	3245	0.8	-	IK20TT	4
A3 (8P) (03-13)										
1.4 TFSI	92	CAXC; CMSA		09/07-03/13	PKJ20CR8	3173	0.8	-	VK20G	4
1.6	75	BGU; BSE; BSF; CCSA		05/03-12/10	K20PBR-S10	5061	1.0	K20TT	IK20TT	4
1.6 E-Power	75	CCSA; CMXA		01/11-03/13	K20PBR-S10	5061	1.0	K20TT	IK20TT	4
1.6 FSI	85	BAG; BLF; BLP		08/03-09/07	K20PBR-S10	5061	1.0	K20TT	IK20TT	4
1.6 TDI	66/77	CAYB; CAYC		05/09-03/13	DG-193		4.4V		4	
1.8 TFSI	118	BYT; BZB; CDAA		11/06-03/13	PK22PR8	3273	0.8	-	VK22	4
1.8 TFSI quattro	118	CDAA		07/08-03/13	PK22PR8	3273	0.8	-	VK22	4
1.9 TDI	77	BKC; BLS; BXE		05/03-05/10	DG-177		5V		4	
2.0 FSI	110	BLY; BMB; BVZ		05/03-06/08	K20PR-U	3145	0.8	K20TT	IK20TT	4
2.0 FSI	110	AXW; BLR; BLX; BVY		05/03-06/08	VKA16	5622	1.1	-	VKA16	4
2.0 TDI	100	AZV		05/03-03/13	DG-190		4.4V		4	
2.0 TDI	125	CBBB; CFGB		03/06-03/13	DG-193		4.4V		4	
2.0 TDI	103	BMM	Ch: 8P-6A138 001; 8P-6B019 001>	06/05-06/08	DG-177		5V		4	
2.0 TDI	103	BMM	Ch: 8P-6A138 001>	06/05-06/08	DG-177		5V		4	
2.0 TDI	103	BMM	Ch: 8P-6B019 001>	06/05-06/08	DG-177		5V		4	
2.0 TDI 16V	103	BKD		05/03-03/13	DG-190		4.4V		4	
2.0 TDI 16V quattro	103	BKD		08/04-03/13	DG-190		4.4V		4	
2.0 TDI quattro	100	AZV		05/03-06/08	DG-190		4.4V		4	
2.0 TDI quattro	125	CBBB; CFGB		03/06-03/13	DG-193		4.4V		4	
2.0 TDI quattro	103	BMM	Ch: 8P-6A138 001>	01/06-06/08	DG-177		5V		4	
2.0 TDI quattro	103	BMM	Ch: 8P-6B019 001>	01/06-06/08	DG-177		5V		4	
2.0 TFSI	147	AXX; BWA; CAWB; CBFA; CCZA		09/04-03/13	PK22PR8	3273	0.8	-	VK22	4
2.0 TFSI quattro	147	AXX; BPY; BWA; CCTA; CCZA		09/04-03/13	PK22PR8	3273	0.8	-	VK22	4
RS3 quattro	250	CEPA		01/11-12/12	VKH22	5619	0.8	-	VKH22	5
S3 quattro	195	BHZ		11/06-06/08	PK20PR-P8	3245	0.8	-	IK20TT	4
S3 quattro	188	BZC		02/07-06/08	PK22PR8	3273	0.8	-	VK22	4
S3 quattro	188/195	BHZ; CDLA; CDLC		06/08-03/13	XU22EPR-U	3179	0.9	XU22TT	VXU22	4
S3 quattro	188/195	CDLA; CDLC	Ch: 8P9A041701, 8P9B006601>	07/08-03/13	PK22PR8	3273	0.8	-	VK22	4
A3 (8V) (12-)										
1.6 TDI	77/81	CLHA; CRKB; CXXB; DBKA		09/13-	DG-193		4.4V		3	

	KW								QTY		
AUDI <i>continued</i>											
A3 (8V) (12-) continued											
2.0 TDI	81/ 100/ 105/ 110/ 135	CRBC; CRBD; CRFA; CRFC; CRLB; CRLC; CUNA		05/13-	DG-193		4.4V			4	
2.0 TDI quattro	110/ 135	CRBC; CRLB; CUNA		10/12-	DG-193		4.4V			4	
A3 Convertible (8P7) (08-13)											
1.4 TFSI	92	CAXC		02/11-05/13	PKJ20CR8	3173	0.8	-	-	VK20G	4
1.6	75	BSE		09/08-05/10	K20PBR-S10	5061	1.0	K20TT	IK20TT	IK20TT	4
1.6 TDI	77	CAYC		05/09-05/13	DG-193		4.4V				4
1.8 TFSI	118	BZB; CDAA		04/08-05/13	PK22PR8	3273	0.8	-	-	VK22	4
1.9 TDI	77	BLS		04/08-10/09	DG-177		5V				4
2.0 TDI	100/ 103	CBAA; CBAB; CFFA; CFFB		04/08-05/13	DG-193		4.4V				4
2.0 TFSI	147	CAWB; CGZA		04/08-05/13	PK22PR8	3273	0.8	-	-	VK22	4
A4 (8D, B5) (94-01)											
1.6	74/75	ADP; ALZ; ANA		11/94-09/01	K20PBR-S10	5061	1.0	K20TT	IK20TT	IK20TT	4
1.8	85/ 92/ 95	ADR; AFY		01/95-11/00	K20PBR-S10	5061	1.0	K20TT	IK20TT	IK20TT	4
1.8 quattro	85/92	ADR; AFY		07/95-09/01	K20PBR-S10	5061	1.0	K20TT	IK20TT	IK20TT	4
1.8 T	110	AEB		01/95-11/00	K20PBR-S10	5061	1.0	K20TT	IK20TT	IK20TT	4
1.8 T	110/ 132	AEB; AJL		03/96-09/01	PK20PR-P8	3245	0.8	-	IK20TT	IK20TT	4
1.8 T quattro	110/ 132	AEB; AJL; ANB		01/96-09/01	PK20PR-P8	3245	0.8	-	IK20TT	IK20TT	4
1.9 DUO	66	AHU		03/98-09/01	DG-005		11V				4
1.9 TDI	55/ 66/ 81/ 85	1Z; AFF; AFN; AHH; AHU; AJM; AVG		03/96-09/01	DG-005		11V				4
1.9 TDI quattro	81/85	AFN; AJM; ATJ; AVG		09/96-09/01	DG-005		11V				4
2.4	120/ 121	AGA; AMM		03/97-09/01	K20TXR	5063	1.0	K20TT	IK20TT	IK20TT	6
2.4 quattro	120/ 121	AGA; APZ		03/97-09/01	K20TXR	5063	1.0	K20TT	IK20TT	IK20TT	6
2.5 TDI	110	AFB; AKN		09/97-09/01	DG-144		11V				6
2.5 TDI quattro	110	AFB; AKN		09/97-09/01	DG-144		11V				6
2.6	110	ABC		01/95-09/01	K20PBR-S10	5061	1.0	K20TT	IK20TT	IK20TT	6
2.6 quattro	110	ABC		01/95-09/01	K20PBR-S10	5061	1.0	K20TT	IK20TT	IK20TT	6
2.8	128	AAH		09/95-07/97	K20PBR-S10	5061	1.0	K20TT	IK20TT	IK20TT	6
2.8	140/ 142	ALG; ATX		10/96-11/00	K20TXR	5063	1.0	K20TT	IK20TT	IK20TT	6
2.8 quattro	128	AAH		01/95-07/97	K20PBR-S10	5061	1.0	K20TT	IK20TT	IK20TT	6
2.8 quattro	140/ 142	ALG; ATX		10/96-09/01	K20TXR	5063	1.0	K20TT	IK20TT	IK20TT	6
RS4 quattro	280	ASJ		05/00-09/01	PK22PR8	3273	0.8	-	-	VK22	6
S4 quattro	195	AGB; AZB		09/97-09/01	PK20PR-P8	3245	0.8	-	IK20TT	IK20TT	6
A4 (8E, B6) (00-04)											
1.6	75	ALZ		11/00-12/04	K20PBR-S10	5061	1.0	K20TT	IK20TT	IK20TT	4
1.6	75	ALZ	OEM Optional	11/00-12/04	PK20PR-P8	3245	0.8	-	IK20TT	IK20TT	4
1.8 T	110/ 120/ 125/ 140	AMB; AVJ; BEX; BFB		09/01-12/04	PK20PR-P8	3245	0.8	-	IK20TT	IK20TT	4
1.8 T quattro	110/ 120/ 125/ 140	AMB; AVJ; BEX; BFB		09/01-12/04	PK20PR-P8	3245	0.8	-	IK20TT	IK20TT	4
1.9 TDI	74/96	AVB; AVF; AWX	Ch: >8E-2-148 697	11/00-12/04	DG-005		11V				4
1.9 TDI	74/96	AVB; AVF; AWX	Ch: 8E-2-148 698>	11/00-12/04	DG-109		11V				4
1.9 TDI	85	BKE	Ch: 8E-5-070 251>	06/04-12/04	DG-177		5V				4
1.9 TDI quattro	96	AVF	Ch: >8E-2-148 697	11/01-12/04	DG-005		11V				4
1.9 TDI quattro	96	AVF	Ch: 8E-2-148 698>	11/01-12/04	DG-109		11V				4
2.0	96	ALT		11/00-12/04	K16TNR-S9	3329	0.9	K16TT	IK16TT	IK16TT	4
2.0 FSI	110	AWA		07/02-12/04	VKA16	5622	1.1	-	-	VKA16	4
2.4	120/ 125	AMM; BDV		09/01-12/04	K20TXR	5063	1.0	K20TT	IK20TT	IK20TT	6
2.5 TDI	114/ 120	AYM; BCZ; BDG; BFC		08/01-12/04	DG-144		11V				6
2.5 TDI quattro	132	AKE; BAU; BDH		11/00-12/04	DG-144		11V				6

Spark & Glow Plugs







Application Tables





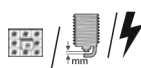

	KW				Standard 			Twin Tip 			QTY
AUDI continued											
A4 (8E, B6) (00-04) continued											
3.0	160/162	ASN; BBJ		11/00-12/04	K20TXR	5063	1.0	K20TT	IK20TT	IK20TT	6
3.0	162	AVK		11/00-06/02	PK20PR-L11	3142	1.1	-	IK20TT	IK20TT	6
3.0 quattro	160/162	ASN; BBJ		11/00-12/04	K20TXR	5063	1.0	K20TT	IK20TT	IK20TT	6
3.0 quattro	162	AVK		11/00-06/02	PK20PR-L11	3142	1.1	-	IK20TT	IK20TT	6
S4 quattro	253	BBK		03/03-12/04	K20PBR-S10	5061	1.0	K20TT	IK20TT	IK20TT	8
A4 (8E, B7) (04-08)											
1.6	75	ALZ		11/04-06/08	K20PBR-S10	5061	1.0	K20TT	IK20TT	IK20TT	4
1.8 T	120	BFB		11/04-06/08	PK20PR-P8	3245	0.8	-	IK20TT	IK20TT	4
1.8 T quattro	120	BFB		11/04-06/08	PK20PR-P8	3245	0.8	-	IK20TT	IK20TT	4
1.9 TDI	85	BKE	Ch: 8E-5-070 251>	11/04-06/08	DG-177		5V				4
2.0	96	ALT		11/04-06/08	K16TNR-S9	3329	0.9	K16TT	IK16TT	IK16TT	4
2.0 TDI	100	BNA		11/04-11/05	DG-190		4.4V				4
2.0 TDI 16V	103	BLB		11/04-11/05	DG-190		4.4V				4
2.0 TFSI	125/147/162	BGB; BPJ; BUL; BWE		06/05-06/08	PK22PR8	3273	0.8	-	-	VK22	4
2.0 TFSI quattro	147/162	BGB; BUL; BWE		11/04-06/08	PK22PR8	3273	0.8	-	-	VK22	4
2.5 TDI	120	BDG		11/04-05/06	DG-144		11V				6
2.7 TDi	120/132	BPP; BSG		11/05-06/08	DG-193		4.4V				6
3.0	160	BBJ		11/04-05/06	K20TXR	5063	1.0	K20TT	IK20TT	IK20TT	6
3.0 quattro	160	BBJ		11/04-07/06	K20TXR	5063	1.0	K20TT	IK20TT	IK20TT	6
3.0 TDI quattro	150/171	ASB; BKN		11/04-06/08	DG-193		4.4V				6
3.2 FSI	188	AUK		01/05-06/08	IK22	5310	0.8	-	-	VK22	6
3.2 FSI quattro	188	AUK		01/05-06/08	IK22	5310	0.8	-	-	VK22	6
RS4 quattro	309	BNS		09/05-06/08	IK22	5310	0.8	-	-	VK22	8
S4 quattro	253	BBK		11/04-06/08	K20PBR-S10	5061	1.0	K20TT	IK20TT	IK20TT	8
A4 (8K, B8) (07-)											
1.8 TFSI	88/118	CABA; CABB; CDHA; CDHB		11/07-	PK22PR8	3273	0.8	-	-	VK22	4
1.8 TFSI quattro	118	CDHB		09/08-	PK22PR8	3273	0.8	-	-	VK22	4
2.0 TDI	88/100/105/110/120/125/130	CAGA; CAGB; CAGC; CAHA; CAHB; CGLC; CGLD; CJCA; CJCB; CJCC; CJCD; CMEA; CMFA; CMFB; CNHC; CSUA; CSUB		04/08-	DG-193		4.4V				4
2.0 TDI quattro	105/110/125/130	CAGA; CAHA; CGLC; CJCA; CJCD; CSUA		04/08-	DG-193		4.4V				4
2.0 TFSI	132/155	CAEB; CDNB; CDNC; CFKA		06/08-	PK22PR8	3273	0.8	-	-	VK22	4
2.0 TFSI flexible fuel quattro	132	CFKA		11/09-	PK22PR8	3273	0.8	-	-	VK22	4
2.0 TFSI quattro	155	CAEB; CDNC; CPMA		06/08-	PK22PR8	3273	0.8	-	-	VK22	4
2.7 TDI	120/140	CAMA; CAMB; CGKA; CGKB		11/07-	DG-193		4.4V				6
3.0 TDI	150	CLAB		11/11-	DG-193		4.4V				6
3.0 TDI quattro	155/176/180	CAPA; CCLA; CCWA; CCWB; CDUC; CKVB		06/08-	DG-193		4.4V				6
3.2 FSI	195	CALA		09/08-	PK20PR-L11	3142	1.1	-	IK20TT	IK20TT	6
3.2 FSI	195	CALA	OEM Optional	09/08-	VK20	5604	1.1	-	IK20TT	IK20TT	6
3.2 FSI quattro	195	CALA		05/09-	PK20PR-L11	3142	1.1	-	IK20TT	IK20TT	6
3.2 FSI quattro	195	CALA	OEM Optional	11/07-	VK20	5604	1.1	-	IK20TT	IK20TT	6
S4 quattro	245	CAKA; CCBA; CGWC; CGXC; CREC; CTUB		11/08-	IK24	5311	0.8	-	-	-	6
A4 Allroad (8KH) (09-)											
2.0 TDI quattro	100/105/110/120/125/130	CAGA; CAGB; CAHA; CAHB; CGLC; CGLD; CJCA; CJCB; CJCD		09/09-	DG-193		4.4V				4
2.0 TFSI quattro	155	CDNC; CPMA		04/09-	PK22PR8	3273	0.8	-	-	VK22	4
3.0 TDI quattro	176/180	CCWA; CDUC; CKVB		04/09-	DG-193		4.4V				6

	KW					Standard			Twin Tip			QTY
AUDI continued												
A4 Convertible (8H, B6, B7) (02-09)												
1.8 T	120	BFB		07/02-03/09	PK20PR-P8	3245	0.8	-	IK20TT	IK20TT		4
1.8 T quattro	120	BFB		05/03-12/05	PK20PR-P8	3245	0.8	-	IK20TT	IK20TT		4
2.0	96	ALT		09/04-12/05	K16TNR-S9	3329	0.9	K16TT	IK16TT	IK16TT		4
2.0 TFSI 16V	147	BWE		01/06-03/09	PK22PR8	3273	0.8	-	-	VK22		4
2.4	120/ 125	AMM; BDV		04/02-12/05	K20TXR	5063	1.0	K20TT	IK20TT	IK20TT		6
2.5 TDI	120	BCZ; BDG; BFC		08/02-12/05	DG-144		11V					6
2.7 TDI	132	BPP		06/06-03/09	DG-193		4.4V					6
3.0	162	ASN; BBJ		04/02-12/05	K20TXR	5063	1.0	K20TT	IK20TT	IK20TT		6
3.0 quattro	162	ASN		05/03-12/05	K20TXR	5063	1.0	K20TT	IK20TT	IK20TT		6
3.0 TDI quattro	150/ 171	ASB; BKN		01/06-03/09	DG-193		4.4V					6
3.2 FSI	188	AUK		01/06-03/09	IK22	5310	0.8	-	-	VK22		6
3.2 FSI quattro	188	AUK		01/06-03/09	IK22	5310	0.8	-	-	VK22		6
RS4 quattro	309	BNS		06/06-03/09	IK22	5310	0.8	-	-	VK22		8
S4 quattro	253	BBK		03/04-03/09	K20PBR-S10	5061	1.0	K20TT	IK20TT	IK20TT		8
A5 (8T, 8F) (07-)												
1.8 TFSI	118/ 125	CABD; CDHB		10/07-09/11	PK22PR8	3273	0.8	-	-	VK22		4
2.0 TDI	100/ 105/ 110/ 120/ 125/ 130/ 140	CAGA; CAGB; CAHA; CAHB; CGLC; CGLD; CJCA; CJCB; CJCD; CMEA; CMFA; CNHA		09/09-	DG-193		4.4V					4
2.0 TDI quattro	125/ 130/ 140	CAHA; CGLC; CNHA		08/08-	DG-193		4.4V					4
2.0 TFSI	132/ 155	CAEA; CAEB; CDNB; CDNC		03/09-	PK22PR8	3273	0.8	-	-	VK22		4
2.0 TFSI quattro	155	CAEB; CDNC		03/09-	PK22PR8	3273	0.8	-	-	VK22		4
2.7 TDI	120/ 140	CAMA; CAMB; CGKA; CGKB		09/07-	DG-193		4.4V					6
3.0 TDI	150	CLAB		10/11-	DG-193		4.4V					6
3.0 TDI quattro	155/ 176/ 180	CAPA; CCWA; CCWB; CDUC; CKVB		03/08-	DG-193		4.4V					6
3.0 TFSI quattro	200	CMUA		11/11-	IK24	5311	0.8	-	-	-		6
3.2 FSI	195	CALA		06/07-	PK20PR-L11	3142	1.1	-	IK20TT	IK20TT		6
3.2 FSI	195	CALA	OEM Optional	06/07-	VK20	5604	1.1	-	IK20TT	IK20TT		6
3.2 FSI quattro	195	CALA		03/09-	PK20PR-L11	3142	1.1	-	IK20TT	IK20TT		6
3.2 FSI quattro	195	CALA	OEM Optional	03/09-	VK20	5604	1.1	-	IK20TT	IK20TT		6
RS 5 quattro	331	CFSA		03/10-	VK22	5610	0.8	-	-	VK22		8
S5 quattro	245	CAKA; CCBA; CGWC; CGXC; CREC; CTDA; CTUB		06/09-	IK24	5311	0.8	-	-	-		6
S5 quattro	260	CAUA		06/07-02/12	VKB20	5625	1.1	-	-	VKB20		8
A6 (4A, C4) (94-97)												
1.8	92	ADR		12/95-12/97	K20PBR-S10	5061	1.0	K20TT	IK20TT	IK20TT		4
1.8 quattro	92	ADR		12/95-12/97	K20PBR-S10	5061	1.0	K20TT	IK20TT	IK20TT		4
1.9 TDI	66	1Z; AHU		06/94-12/97	DG-005		11V					4
2.0	74/85	AAE; ABK		06/94-12/97	W20EPBR-S	5067	0.85	W20TT	IW20TT	IW20TT		4
2.0 16V	103	ACE		06/94-12/97	K22PBR-S	5062	0.85	-	-	VK22		4
2.0 16V quattro	103	ACE		06/94-12/97	K22PBR-S	5062	0.85	-	-	VK22		4
2.3	98	AAR		06/94-12/95	W16ETR-S	3285	1.0	W16TT	IW16TT	IW16TT		5
2.3 quattro	98	AAR		06/94-12/95	W16ETR-S	3285	1.0	W16TT	IW16TT	IW16TT		5
2.5 TDI	84/ 85/ 103	AAT; AEL		06/94-12/97	DG-005		11V					5
2.5 TDI quattro	103	AEL		07/95-12/97	DG-005		11V					5
2.6	102/ 110	ABC; ACZ		06/94-12/97	K20PBR-S10	5061	1.0	K20TT	IK20TT	IK20TT		6
2.6 quattro	110	ABC		06/94-12/97	K20PBR-S10	5061	1.0	K20TT	IK20TT	IK20TT		6
2.8	128	AAH; AFC		06/94-12/97	K20PBR-S10	5061	1.0	K20TT	IK20TT	IK20TT		6
2.8	142	ACK		12/95-12/97	K20TXR	5063	1.0	K20TT	IK20TT	IK20TT		6
2.8 quattro	128	AAH		06/94-12/97	K20PBR-S10	5061	1.0	K20TT	IK20TT	IK20TT		6
2.8 quattro	142	ACK		12/95-12/97	K20TXR	5063	1.0	K20TT	IK20TT	IK20TT		6
S6 4.2 quattro	213	AEC		06/94-12/97	T20EPR-U	5032	0.8	T20TT	IT20TT	IT20TT		8
S6 Plus quattro	240	AHK		04/96-12/97	T20EPR-U	5032	0.8	T20TT	IT20TT	IT20TT		8
S6 Turbo quattro	169	AAN		06/94-12/97	PK22PR8	3273	0.8	-	-	VK22		5
A6 (4B, C5) (97-05)												
1.8	85/92	AFY; AJP		12/97-01/05	K20PBR-S10	5061	1.0	K20TT	IK20TT	IK20TT		4

Spark & Glow Plugs







Application Tables







	KW								QTY
AUDI continued									
A6 (4B, C5) (97-05) continued									
1.8 T	110/132	AEB; AJL		01/97-01/05	PK20PR-P8	3245 0.8	-	IK20TT	4
1.8 T quattro	110/132	AEB; AJL; APU		12/97-01/05	PK20PR-P8	3245 0.8	-	IK20TT	4
1.9 TDI	81	AFN; AVG		04/97-04/01	DG-005	11V			4
1.9 TDI	85/96	AJM; AVF; AWX		07/00-01/05	DG-109	11V			4
2.0	96	ALT		08/01-01/05	K20PBR-S10	5061 1.0	K20TT	IK20TT	4
2.4	100	ALW		07/98-01/05	K20PBR-S10	5061 1.0	K20TT	IK20TT	6
2.4	115/120/121/125	AML; AMM; APC; APZ; ARJ; BDV		02/97-01/05	K20TXR	5063 1.0	K20TT	IK20TT	6
2.4 quattro	115/120/121/125	AGA; APC; APZ; BDV		08/98-01/05	K20TXR	5063 1.0	K20TT	IK20TT	6
2.5 TDI	110/114/120/132	AFB; AKE; AKN; AYM; BAU; BCZ; BDG; BDH; BFC; BND		07/97-01/05	DG-144	11V			6
2.5 TDI quattro	110/132	AFB; AKE; AKN; BAU; BDH		07/97-01/05	DG-144	11V			6
2.7 T	169	AJK		02/99-01/05	PK20PR-P8	3245 0.8	-	IK20TT	6
2.7 T quattro	169/184	AJK; ARE; AZA		12/97-01/05	PK20PR-P8	3245 0.8	-	IK20TT	6
2.8	132/140/142	AGE; ALG; AMX; ATX		02/97-01/05	K20TXR	5063 1.0	K20TT	IK20TT	6
2.8 quattro	132/140/142	AGE; ALG; APR; ATX		02/97-01/05	K20TXR	5063 1.0	K20TT	IK20TT	6
3.0	162	ASN		08/01-01/05	K20TXR	5063 1.0	K20TT	IK20TT	6
3.0 quattro	160/162	ASN; BBJ		06/01-01/05	K20TXR	5063 1.0	K20TT	IK20TT	6
4.2 quattro	220	ARS		11/98-01/05	PK20PTR-S9	3380 0.9	K20TT	IK20TT	8
RS6 plus quattro	353	BRV		04/04-01/05	PK22PR8	3273 0.8	-	VK22	8
RS6 quattro	331	BCY		07/02-01/05	PK22PR8	3273 0.8	-	VK22	8
S6 quattro	250	AQJ		09/99-01/05	K20TXR	5063 1.0	K20TT	IK20TT	8
A6 (4F, C6) (04-11)									
2.0 TDI	100/103	BLB; BNA		07/04-08/11	DG-190	4.4V			4
2.0 TDI	89/100/120/125	BVG; CAGB; CAHA; CAHB		06/05-08/11	DG-193	4.4V			4
2.0 TFSI	125	BPJ		06/05-08/11	PK22PR8	3273 0.8	-	VK22	4
2.4	130	BDW		05/04-10/08	PK20PR-L11	3142 1.1	-	IK20TT	6
2.4 quattro	130	BDW		01/05-10/08	PK20PR-L11	3142 1.1	-	IK20TT	6
2.7 TDI	120/132/140	BPP; BSG; CANA; CANB		03/05-08/11	DG-193	4.4V			6
2.7 TDI quattro	120/132/140	BPP; BSG; CANC; CAND		06/05-08/11	DG-193	4.4V			6
2.8 FSI	140/154/162	BDX; CCDA; CCEA		10/08-08/11	PK20PR-L11	3142 1.1	-	IK20TT	6
2.8 FSI quattro	140/154/162	BDX; CCDA; CCEA		10/08-08/11	PK20PR-L11	3142 1.1	-	IK20TT	6
3.0	160	BBJ		03/05-05/06	PK20PR-L11	3142 1.1	-	IK20TT	6
3.0 quattro	160	BBJ		05/04-05/06	PK20PR-L11	3142 1.1	-	IK20TT	6
3.0 TDI	171	ASB		06/06-08/11	DG-193	4.4V			6
3.0 TDI quattro	155/165/171/176	ASB; BMK; BNG; CDYA; CDYB; CDYC		03/05-08/11	DG-193	4.4V			6
3.0 TFSI quattro	220	CCAA		10/08-08/11	IK24	5311 0.8	-	-	6
3.0 TFSI quattro	213	CAJA		10/08-08/11	VK22	5610 0.8	-	VK22	6
3.2 FSI	188	AUK		05/04-05/09	IK22	5310 0.8	-	VK22	6
3.2 FSI quattro	188	AUK		05/04-10/08	IK22	5310 0.8	-	VK22	6
4.2 FSI quattro	257	BVJ		06/06-08/11	VKB20	5625 1.1	-	VKB20	8
4.2 quattro	246	BAT		05/04-05/06	K20PBR-S10	5061 1.0	K20TT	IK20TT	8
RS6 quattro	426	BUH		04/08-08/10	PK20PR-P8	3245 0.8	-	IK20TT	10
S6 quattro	320	BXA		03/06-09/08	VK22	5610 0.8	-	VK22	10
S6 quattro	320	BXA		10/08-08/11	VKB20	5625 1.1	-	VKB20	10

	KW					Standard		Twin Tip		QTY	
AUDI continued											
A6 (4G, C7) (10-)											
2.0 TDI	100/120/130/140	CGLC; CGLD; CGLE; CMGB; CNHA; CSUE		01/12-	DG-193		4.4V			4	
2.0 TFSI	132/155/162	CAEB; CAED; CDNB		06/11-	PK22PR8	3273	0.8	-	-	VK22	4
2.0 TFSI	132	CDNB		05/11-	VK22	5610	0.8	-	-	VK22	4
2.8 FSI	150	CHVA		03/11-	VK20	5604	1.1	-	IK20TT	IK20TT	6
2.8 FSI quattro	150	CHVA		03/11-	VK20	5604	1.1	-	IK20TT	IK20TT	6
3.0 TDI	150	CLAB		11/10-	DG-193		4.4V			6	
3.0 TDI quattro	150/180/230	CDUC; CGQB; CKVB; CLAA		03/11-	DG-193		4.4V			6	
3.0 TFSI quattro	220	CGWB		11/10-05/12	IK24	5311	0.8	-	-	-	6
3.0 TFSI quattro	228	CGWD; CGXB; CTUA	40000km Lifetime	03/11-	IK24	5311	0.8	-	-	-	6
A6 Allroad (4FH) (06-11)											
2.7 TDI quattro	120/132/140	BPP; BSG; CANC; CAND		05/06-08/11	DG-193		4.4V			6	
3.0 TDI quattro	155/171/176	ASB; BNG; CDYA; CDYB; CDYC		05/06-08/11	DG-193		4.4V			6	
3.0 TFSI quattro	213	CAJA		10/08-08/11	VK22	5610	0.8	-	-	VK22	6
3.2 FSI quattro	188	AUK		05/06-10/08	IK22	5310	0.8	-	-	VK22	6
4.2 FSI quattro	257	BVJ		05/06-12/10	VKB20	5625	1.1	-	-	VKB20	8
A6 Allroad (4GH) (12-)											
3.0 TDI quattro	150/180/230	CDUD; CGQB; CKVC; CLAA		01/12-	DG-193		4.4V			6	
A7 (4GA) (10-)											
2.8 FSI	150	CHVA		02/11-	VK20	5604	1.1	-	IK20TT	IK20TT	6
2.8 FSI quattro	150	CHVA		10/10-	VK20	5604	1.1	-	IK20TT	IK20TT	6
3.0 TDI	150	CLAB		11/10-	DG-193		4.4V			6	
3.0 TDI quattro	150/180/230	CDUC; CDUD; CGQB; CKVB; CKVC; CLAA		12/10-	DG-193		4.4V			6	
3.0 TFSI quattro	220/228	CGWB; CGXB; CHMA		10/10-	IK24	5311	0.8	-	-	-	6
A8 (4D) (94-02)											
2.5 TDI	110/132	AFB; AKE; AKN		01/97-09/02	DG-144		11V			6	
2.5 TDI quattro	110/132	AFB; AKE; AKN		07/97-09/02	DG-144		11V			6	
2.8	120	AEJ		07/95-03/96	K16PR-U	3191	0.8	K16TT	IK16TT	IK16TT	6
2.8	128	AAH		03/94-03/96	K20PBR-S10	5061	1.0	K20TT	IK20TT	IK20TT	6
2.8	142	ALG		04/96-09/02	K20TXR	5063	1.0	K20TT	IK20TT	IK20TT	6
2.8 quattro	120	AEJ		07/95-03/96	K16PR-U	3191	0.8	K16TT	IK16TT	IK16TT	6
2.8 quattro	128	AAH		03/94-03/96	K20PBR-S10	5061	1.0	K20TT	IK20TT	IK20TT	6
2.8 quattro	142	AMX		04/96-09/02	K20TXR	5063	1.0	K20TT	IK20TT	IK20TT	6
3.3 TDI quattro	165	AKF		06/00-09/02	DG-144		11V			8	
3.7	191	AKC		11/98-09/02	PK20PTR-S9	3380	0.9	K20TT	IK20TT	IK20TT	8
3.7	169	AEW		07/95-12/98	T20EPR-U	5032	0.8	T20TT	IT20TT	IT20TT	8
3.7 quattro	191	AKC		11/98-09/02	PK20PTR-S9	3380	0.9	K20TT	IK20TT	IK20TT	8
3.7 quattro	169	AEW		07/95-11/98	T20EPR-U	5032	0.8	T20TT	IT20TT	IT20TT	8
4.2 quattro	175/228	AQF; ARU		11/98-09/02	PK20PTR-S9	3380	0.9	K20TT	IK20TT	IK20TT	8
4.2 quattro	180/220	ABZ; AEM		03/94-11/98	T20EPR-U	5032	0.8	T20TT	IT20TT	IT20TT	8
6.0 W12 quattro	309	AZC		01/01-09/02	PKJ20CR-L11	3247	1.1	-	IK20TT	IK20TT	12
S 8 quattro	265	AVP		06/99-09/02	K20TXR	5063	1.0	K20TT	IK20TT	IK20TT	8
S 8 quattro	250	AKH		07/96-06/99	T20EPR-U	5032	0.8	T20TT	IT20TT	IT20TT	8
A8 (4E) (02-10)											
2.8 FSI	154	BDX		08/07-07/10	PK20PR-L11	3142	1.1	-	IK20TT	IK20TT	6
3.0	160/162	ASN; BBJ		07/03-05/06	K20TXR	5063	1.0	K20TT	IK20TT	IK20TT	6
3.0 TDI quattro	171	ASB		08/03-07/10	DG-144		11V			6	
3.0 TDI quattro	155	BNG		11/03-07/10	DG-193		4.4V			6	
3.2 FSI	191	BPK		06/05-10/07	IK22	5310	0.8	-	-	VK22	6
3.2 FSI quattro	191	BPK		06/05-07/10	IK22	5310	0.8	-	-	VK22	6
3.7 quattro	206	BFL		10/02-05/06	K20PBR-S10	5061	1.0	K20TT	IK20TT	IK20TT	8
4.0 TDI quattro	202	ASE		05/03-07/05	DG-144		11V			8	
4.2 FSI quattro	257	BVJ		06/06-07/10	VKB20	5625	1.1	-	-	VKB20	8

Spark & Glow Plugs







Application Tables







	KW				Standard 			Twin Tip 			QTY
AUDI <i>continued</i>											
A8 (4E) (02-10) <i>continued</i>											
4.2 quattro	246	BFM		10/02-05/06	K20PBR-S10	5061	1.0	K20TT	IK20TT	IK20TT	8
4.2 TDI quattro	235/ 240	BMC; BVN		01/05-07/10	DG-193		4.4V				8
6.0 W12 quattro	331	BHT; BTE		12/03-07/10	PKJ20CR-L11	3247	1.1	-	IK20TT	IK20TT	12
S8 quattro	331	BSM		06/06-07/10	VKB20	5625	1.1	-	-	VKB20	10
A8 (4H) (09-)											
3.0 TDI	150	CLAB		09/11-	DG-193		4.4V				6
3.0 TDI quattro	155/ 184	CDTA; CDTB; CMHA		07/10-	DG-193		4.4V				6
3.0 TFSI quattro	213/ 245	CGWA; CGXC		06/10-	IK24	5311	0.8	-	-	-	6
4.2 FSI quattro	273	CDRA		11/09-	VKB20	5625	1.1	-	-	VKB20	8
4.2 TDI quattro	258	CDSB		11/09-	DG-193		4.4V				8
6.3 W12 quattro	368	CEJA; CTNA		01/11-	VXUH22I	5656	0.9	-	-	VXUH22I	12
ALLROAD (4BH) (00-05)											
2.5 TDI quattro	120/ 132	AKE; BAU; BCZ		05/00-08/05	DG-144		11V				6
2.7 T quattro	184	ARE; BES		05/00-08/05	PK20PR-P8	3245	0.8	-	IK20TT	IK20TT	6
4.2 V8 quattro	220	BAS		07/02-08/05	K20PBR-S10	5061	1.0	K20TT	IK20TT	IK20TT	8
CABRIOLET (8G7) (91-00)											
1.8	92	ADR		01/97-08/00	K20PBR-S10	5061	1.0	K20TT	IK20TT	IK20TT	4
1.9 TDI	66	1Z; AHU		06/95-08/00	DG-005		11V				4
2.0 16V	103	ACE		06/95-07/96	K22PBR-S	5062	0.85	-	-	VK22	4
2.0 E	85	ABK		01/93-07/98	W20EPBR-S	5067	0.85	W20TT	IW20TT	IW20TT	4
2.3 E	98	NG		05/91-07/94	W16ETR-S	3285	1.0	W16TT	IW16TT	IW16TT	5
2.6	102/ 110	ABC; ACZ		06/93-08/00	K20PBR-S10	5061	1.0	K20TT	IK20TT	IK20TT	6
2.8	128	AAH		11/92-08/00	K20PBR-S10	5061	1.0	K20TT	IK20TT	IK20TT	6
COUPE (81, 85) (80-88)											
1.6	55	YN		07/80-08/81	W20EPR-U	3047	0.8	W20TT	IW20TT	IW20TT	4
1.8	55	DD		08/81-07/83	W20EP-U	3043	0.8	W20TT	IW20TT	IW20TT	4
1.8 GT	65	SF		04/86-10/88	IW20	5306	1.1	-	IW20TT	IW20TT	4
1.8 GT	66/82	DZ; JV		09/82-10/88	W20EPB	5065	0.85	W20TT	IW20TT	IW20TT	4
1.8 GT	68	JN		01/85-07/88	W20EPBR-S	5067	0.85	W20TT	IW20TT	IW20TT	4
1.9	85	WN		08/80-07/83	W22EPB	5066	0.85	W22TT	-	VW22	5
2.0	85	JS		09/83-07/86	W20EPB	5065	0.85	W20TT	IW20TT	IW20TT	5
2.1 GT	96	KL		09/82-10/87	W20EPB	5065	0.85	W20TT	IW20TT	IW20TT	5
2.1 GT	79	WE		01/81-07/83	W20EPR-U	3047	0.8	W20TT	IW20TT	IW20TT	5
2.2 GT	85/ 100	KV; KX		07/81-10/88	W20EPB	5065	0.85	W20TT	IW20TT	IW20TT	5
2.2 quattro	88/ 100	JT; KV		10/84-10/88	W20EPB	5065	0.85	W20TT	IW20TT	IW20TT	5
2.3	100	NG		01/87-10/88	W16ETR-S	3285	1.0	W16TT	IW16TT	IW16TT	5
2.3 quattro	100	NG		01/87-10/88	W20EPB	5065	0.85	W20TT	IW20TT	IW20TT	5
COUPE (89, 8B) (88-96)											
1.8	82	DZ		08/89-07/91	W20EPB	5065	0.85	W20TT	IW20TT	IW20TT	4
2.0	83/85	3A; ABK		05/89-12/96	W20EPBR-S	5067	0.85	W20TT	IW20TT	IW20TT	4
2.0 16 V	103	ACE		08/92-12/96	IK22	5310	0.8	-	-	VK22	4
2.0 16 V	101	6A		01/92-07/92	K22PBR-S	5062	0.85	-	-	VK22	4
2.0 20 V	118	NM		08/89-07/91	K22PB	5069	0.85	-	-	VK22	5
2.0 20 V quattro	118	NM		08/89-07/91	K22PB	5069	0.85	-	-	VK22	5
2.2 quattro	100	KV		11/88-07/91	W20EPB	5065	0.85	W20TT	IW20TT	IW20TT	5
2.3	100	NG		10/88-07/94	W16ETR-S	3285	1.0	W16TT	IW16TT	IW16TT	5
2.3	98	NG		03/90-12/96	W20EPBR-S	5067	0.85	W20TT	IW20TT	IW20TT	5
2.3 20V	123/ 125	7A		08/89-07/91	K22PBR-S	5062	0.85	-	-	VK22	5
2.3 20V quattro	123/ 125	7A		11/88-12/96	K22PBR-S	5062	0.85	-	-	VK22	5
2.3 quattro	98/ 100	NG		11/88-12/96	W16ETR-S	3285	1.0	W16TT	IW16TT	IW16TT	5
2.6	110	ABC		08/92-12/96	K20PBR-S10	5061	1.0	K20TT	IK20TT	IK20TT	6
2.6 quattro	110	ABC		08/92-12/96	K20PBR-S10	5061	1.0	K20TT	IK20TT	IK20TT	6
2.8	128	AAH		09/91-12/96	K20PBR-S10	5061	1.0	K20TT	IK20TT	IK20TT	6
2.8 quattro	128	AAH		08/91-12/96	K20PBR-S10	5061	1.0	K20TT	IK20TT	IK20TT	6
S2 quattro	162/ 169	3B; ABY		09/90-12/96	PK22PR8	3273	0.8	-	-	VK22	5
Q3 (8U) (11-)											
2.0 TDI	100/ 103	CFFA; CFFB; CLJA		09/11-	DG-193		4.4V				4
2.0 TDI quattro	103/ 120/ 130	CFFB; CFGC; CFGD; CLLB		06/11-	DG-193		4.4V				4







	KW					Standard		Twin Tip		QTY	
AUDI <i>continued</i>											
Q3 (8U) (11-) <i>continued</i>											
2.0 TFSI quattro	125/ 155	CCZC; CPSA		06/11-	PK22PR8	3273	0.8	-	-	VK22	4
Q5 (8R) (08-)											
2.0 TDI	100/ 105/ 110	CJCA; CJCB; CJCD; CSUA; CSUB		11/10-	DG-193		4.4V				4
2.0 TDI quattro	100/ 105/ 110/ 120/ 125/ 130/ 140	CAGA; CAGB; CAHA; CAHB; CGLA; CGLB; CGLC; CGLD; CJCA; CJCB; CJCD; CMGA; CMGB; CNHA; CNHC; CSUA; CSUB		08/09-	DG-193		4.4V				4
2.0 TFSI hybrid quattro	155	CHJA		06/11-	PK22PR8	3273	0.8	-	-	VK22	4
2.0 TFSI quattro	132/ 155	CAEB; CDNB; CDNC		11/08-	PK22PR8	3273	0.8	-	-	VK22	4
3.0 TDI quattro	155/ 176/ 180/ 190	CCWA; CCWB; CDUD; CPNB; CTBA		11/08-	DG-193		4.4V				6
3.2 FSI quattro	199	CALB		11/08-	PK20PR-L11	3142	1.1	-	IK20TT	IK20TT	6
3.2 FSI quattro	199	CALB	OEM Optional	11/08-	VK20	5604	1.1	-	IK20TT	IK20TT	6
Q7 (4L) (06-)											
3.0 TDI	150/ 155/ 165/ 171/ 176/ 180	BUG; BUN; CASA; CASB; CATA; CCMA; CJGA; CJGC; CJGD, CRCA; CJMA; CLZB		05/10-	DG-193		4.4V				6
3.0 TFSI	200/ 245	CJTB - E5; CJTC - E5		05/10-	VK22	5610	0.8	-	-	VK22	6
3.6 FSI	206	BHK		08/06-05/10	VXUHC22G	5652	0.9	-	-	VXHUC22G	6
4.2 FSI	257	BAR		03/06-05/10	VKB20	5625	1.1	-	-	VKB20	8
4.2 TDI	240/ 250	BTR; CCFA; CCFC		03/07-	DG-193		4.4V				8
6.0 TDI	368	CCGA		09/08-	DG-193		4.4V				12
QUATTRO (85) (80-91)											
2.1 Turbo	147	GV; WR		07/80-07/87	W22EPR-U	3088	0.8	W22TT	-	VW22	5
2.2 20V Turbo	162	RR		08/89-07/91	PK22PR8	3273	0.8	-	-	VK22	5
2.2 Turbo	147	1B		08/87-07/89	W20EPB	5065	0.85	W20TT	IW20TT	IW20TT	5
R8 (07-)											
4.2 FSI quattro	309/ 316	BYH; CNDA		04/07-	VK22	5610	0.8	-	-	VK22	8
5.2 FSI quattro	386/ 412	BUJ; CMPA		02/10-	PK22PR8	3273	0.8	-	-	VK22	10
TT (8J) (06-14)											
1.8 TFSI	118	CDA		06/08-06/14	PK22PR8	3273	0.8	-	-	VK22	4
2.0 TDI quattro	125	CBBB; CFGB		06/08-06/14	DG-193		4.4V				4
2.0 TFSI	147/ 155	BPY; BWA; CCTA; CESA		03/07-06/14	PK22PR8	3273	0.8	-	-	VK22	4
2.0 TFSI quattro	147/ 155	BWA; CCZA; CESA; CETA		06/08-06/14	PK22PR8	3273	0.8	-	-	VK22	4
2.0 TTS quattro	195/ 200	CDLA; CDLB; CDMA		05/08-06/14	PK22PR8	3273	0.8	-	-	VK22	4
2.5 RS quattro	250/ 265	CEPA; CEPB		07/09-06/14	VKH22	5619	0.8	-	-	VKH22	5
TT (8N) (98-06)											
1.8 T	110/ 120/ 132/ 140	AJQ; APP; AUM; AUQ; BVP; BVR		01/01-06/06	PK20PR-P8	3245	0.8	-	IK20TT	IK20TT	4
1.8 T	132	AJQ	Ch: >X-015 500	10/98-01/99	K20PBR-S10	5061	1.0	K20TT	IK20TT	IK20TT	4
1.8 T quattro	132/ 140/ 165/ 176	AJQ; APX; ARY; AUQ; BAM; BFV; BVR		02/00-06/06	PK20PR-P8	3245	0.8	-	IK20TT	IK20TT	4
1.8 T quattro	132/ 165	AJQ; APX	Ch: >X-015 500	10/98-01/99	K20PBR-S10	5061	1.0	K20TT	IK20TT	IK20TT	4
1.8 T quattro	132/ 165	AJQ; APX; ARY; AUQ; BAM	Ch: X-015 501>	10/98-06/06	PK20PR-P8	3245	0.8	-	IK20TT	IK20TT	4
3.2 VR6 quattro	184	BHE		07/03-06/06	PK20PR-P8	3245	0.8	-	IK20TT	IK20TT	6
V8 (44, 4C) (88-94)											
3.6 quattro	180/ 184	PT		10/88-02/94	T20EPR-U	5032	0.8	T20TT	IT20TT	IT20TT	8
4.2 quattro	206	ABH		10/91-02/94	T20EPR-U	5032	0.8	T20TT	IT20TT	IT20TT	8







Spark & Glow Plugs

Application Tables

	KW					Standard			Twin Tip				QTY	
AUSTIN														
1000-Series (70-74)														
1100	32			01/70-12/74	Q20PR-U	3007	0.8	Q20TT	IQ20TT	IQ20TT			4	
1300	39			01/70-12/74	W20EP-U	3043	0.8	W20TT	IW20TT	IW20TT			4	
1300 GT	50			01/70-12/74	W20EP-U	3043	0.8	W20TT	IW20TT	IW20TT			4	
ALLEGRO (73-84)														
1.0	33	99 H		01/80-10/83	W20EPR-U	3047	0.8	W20TT	IW20TT	IW20TT			4	
1.1	33/36	10H		05/73-10/81	W20EPR-U	3047	0.8	W20TT	IW20TT	IW20TT			4	
1.3	40/ 43/ 46	12 L; 12H		05/73-10/83	W20EPR-U	3047	0.8	W20TT	IW20TT	IW20TT			4	
1.5 Super	50	14H		05/73-03/82	W20EPR-U	3047	0.8	W20TT	IW20TT	IW20TT			4	
1750	67	17LA		01/75-10/79	W20EPR-U	3047	0.8	W20TT	IW20TT	IW20TT			4	
AMBASSADOR (82-84)														
1.7	62	17H979		03/82-02/84	T20EPR-U	5032	0.8	T20TT	IT20TT	IT20TT			4	
2.0	69	20H979		03/82-10/84	T20EPR-U	5032	0.8	T20TT	IT20TT	IT20TT			4	
MAESTRO (83-92)														
1.3	46	12HA20		03/83-08/85	W20EP-U	3043	0.8	W20TT	IW20TT	IW20TT			4	
1.3 LS	49	12H959;12HA04; 12HA20, 12HC32, 12HC34, 12HE		03/83-04/87	W20EP-U	3043	0.8	W20TT	IW20TT	IW20TT			4	
1.6	59	16HA01;16HA03		03/83-10/84	K20PR-U	3145	0.8	K20TT	IK20TT	IK20TT			4	
1.6 Mayfair HLS	61	16H;16HA03; 16HA36, 16HB77, 16HC37, 16HC38	Check Hex size	03/83-08/90	K20PR-U	3145	0.8	K20TT	IK20TT	IK20TT			4	
1.6 Mayfair HLS	61	16H;ROVE10	Check Hex size	03/83-01/86	W20EP-U	3043	0.8	W20TT	IW20TT	IW20TT			4	
1.6 MG	73	16H		01/86-08/90	K20PR-U	3145	0.8	K20TT	IK20TT	IK20TT			4	
1.6 MG	72/73	16H956;16H		03/83-01/86	W20EP-U	3043	0.8	W20TT	IW20TT	IW20TT			4	
2.0 EFI	83	20HA51;20HC78		10/84-08/90	W20EPR-U	3047	0.8	W20TT	IW20TT	IW20TT			4	
MAXI (69-82)														
1500	50	14H(68)		01/77-07/80	W20EPR-U	3047	0.8	W20TT	IW20TT	IW20TT			4	
1750	53	17H(72)		01/77-06/81	W20EPR-U	3047	0.8	W20TT	IW20TT	IW20TT			4	
1750 HL	66	17H(72)		01/77-10/80	W20EPR-U	3047	0.8	W20TT	IW20TT	IW20TT			4	
METRO (80-90)														
1.0	30	99H		10/84-04/90	W16EPR-U	3021	0.8	W16TT	IW16TT	IW16TT			4	
1.0	30/33	99H;99H907P; 99H929P, 99H962P; 99H962P		10/80-04/90	W20EP-U	3043	0.8	W20TT	IW20TT	IW20TT			4	
1.0 Surf HLE	35	99H;99H907P; 99H929P, 99H962P		10/80-09/84	W20EP-U	3043	0.8	W20TT	IW20TT	IW20TT			4	
1.3	46/ 51/ 52	12H;12H907AA; 12H907AA; 12H996AA		10/80-09/84	W20EX-U	3062	0.8	W20TT	IW20TT	IW20TT			4	
1.3 L,HLE,S	44	12H;12H907AA; 12H996AA, 12HC14		05/82-04/90	W20EX-U	3062	0.8	W20TT	IW20TT	IW20TT			4	
1.3 Surf (XF)	44	12H		11/85-04/90	W20EX-U	3062	0.8	W20TT	IW20TT	IW20TT			4	
1.3 Turbo	66	12H959AA;12HC15		10/83-04/90	W20EX-U	3062	0.8	W20TT	IW20TT	IW20TT			4	
MINI (60-93)														
0.9	25			09/69-10/85	W20EPR-U	3047	0.8	W20TT	IW20TT	IW20TT			4	
1.0	44			09/62-08/69	W20EPR-U	3047	0.8	W20TT	IW20TT	IW20TT			4	
1.1	46			11/62-08/64	W20EPR-U	3047	0.8	W20TT	IW20TT	IW20TT			4	
1.3	48/ 53/ 57	12 H; 12 HC		09/62-09/80	W20EPR-U	3047	0.8	W20TT	IW20TT	IW20TT			4	
850	25	BMC Serie A		01/60-08/79	W20EPR-U	3047	0.8	W20TT	IW20TT	IW20TT			4	
1000	26/ 28/ 29	99 H		10/67-09/84	W20EPR-U	3047	0.8	W20TT	IW20TT	IW20TT			4	
1000 Mayfair	31	99 H997P; 99 HA53P; 99 HC20P		08/82-06/93	W20EPR-U	3047	0.8	W20TT	IW20TT	IW20TT			4	
1000 Mayfair Sport	30	99 HD81		09/88-06/93	W20EPR-U	3047	0.8	W20TT	IW20TT	IW20TT			4	
1100 Special	33	10 H		01/76-08/81	W20EPR-U	3047	0.8	W20TT	IW20TT	IW20TT			4	
1275 GT	39			10/69-08/80	W20EPR-U	3047	0.8	W20TT	IW20TT	IW20TT			4	
Cooper	41			01/61-12/67	W20EPR-U	3047	0.8	W20TT	IW20TT	IW20TT			4	
Cooper S	55			01/64-12/80	W20EPR-U	3047	0.8	W20TT	IW20TT	IW20TT			4	
MONTEGO (84-92)														
1.3	50	12 HL		10/84-08/88	W20EPR-U	3047	0.8	W20TT	IW20TT	IW20TT			4	
1.6 LS	61	16HA35;16HA35S		10/84-08/88	K20PR-U	3145	0.8	K20TT	IK20TT	IK20TT			4	
1.6 LS,HL	61	16HA35		04/84-08/88	K20PR-U	3145	0.8	K20TT	IK20TT	IK20TT			4	
2.0	74	20HA30;20HB43; 20HB59		04/84-08/91	W20EPR-U	3047	0.8	W20TT	IW20TT	IW20TT			4	
2.0 HLI	83	20 H		10/84-08/88	W20EPR-U	3047	0.8	W20TT	IW20TT	IW20TT			4	
2.0 Mayfair	83	20 H(EFI)		04/84-08/88	W20EPR-U	3047	0.8	W20TT	IW20TT	IW20TT			4	







	KW					Standard		Twin Tip		QTY	
AUSTIN <i>continued</i>											
MONTEGO (84-92) <i>continued</i>											
2.0 Turbo	110	20HA30		04/84-01/86	W20EPR-U	3047	0.8	W20TT	IW20TT	IW20TT	4
PRINCESS (76-82)											
1800 HL	60	18H		04/76-09/78	W20EPR-U	3047	0.8	W20TT	IW20TT	IW20TT	4
2200	82	23H		10/78-10/82	W20EPR-U	3047	0.8	W20TT	IW20TT	IW20TT	6
2200 HLS	81	23H		04/76-09/78	W20EPR-U	3047	0.8	W20TT	IW20TT	IW20TT	6
AUSTIN-HEALEY											
AUSTIN-HEALEY (64-71)											
1.3	48	12CC		03/66-10/71	W20EX-U	3062	0.8	W20TT	IW20TT	IW20TT	4
3.0 Sport	110			03/64-10/68	W20EP-U	3043	0.8	W20TT	IW20TT	IW20TT	6
Sprite MK.III	41			03/64-09/66	W20EP-U	3043	0.8	W20TT	IW20TT	IW20TT	4
AUTO UNION											
AU 1000 (58-65)											
1.0 S	37			08/59-03/64	MW17	5088	0.7	-	-	-	3
DKW F11 (59-66)											
0.7 Junior	25			02/59-08/61	MW17	5088	0.7	-	-	-	3
AUTOBIANCHI											
A 112 (69-85)											
0.9	32	A112A200		10/69-12/72	W20EPR-U	3047	0.8	W20TT	IW20TT	IW20TT	4
0.9 Junior	31	A112A000;A112A200		07/79-12/85	W20EPR-U	3047	0.8	W20TT	IW20TT	IW20TT	4
1.0 Abarth	51	A112AB2C0		06/75-12/84	W22EPR-U	3088	0.8	W22TT	-	VW22	4
1.0 E,Elite,LX	35	A112B1000		11/77-12/85	W20EPR-U	3047	0.8	W20TT	IW20TT	IW20TT	4
Y10 (85-95)											
1.0	33	156A2.000		03/85-09/92	K20PR-U	3145	0.8	K20TT	IK20TT	IK20TT	4
1.0	41	156A.000		03/85-12/88	W20EPR-U	3047	0.8	W20TT	IW20TT	IW20TT	4
1.0 4WD	37	156A3.000		12/86-12/88	K20PR-U	3145	0.8	K20TT	IK20TT	IK20TT	4
1.0 CAT	33	156A2.246		01/89-09/92	K20PR-U	3145	0.8	K20TT	IK20TT	IK20TT	4
1.0 Turbo	63	156A1.000		03/85-12/88	W24ESR-U	4033	0.8	-	-	-	4
1.1	42	156C.000		06/89-12/94	K20PR-U	3145	0.8	K20TT	IK20TT	IK20TT	4
1.1 4WD	42	156C.000; 176B2.000		06/89-10/95	K20PR-U	3145	0.8	K20TT	IK20TT	IK20TT	4
1.1 i.e. CAT	42	156C.046;176B2.000		09/90-10/95	K20PR-U	3145	0.8	K20TT	IK20TT	IK20TT	4
1.3 i.e. GT	54/57	146A5.046; 156B.000		06/89-10/95	W20EPR-U	3047	0.8	W20TT	IW20TT	IW20TT	4
BEDFORD											
ASTRA VAN (82-91)											
1.3	44/55	13 NB; 13 S		09/84-09/89	W22EPR-U	3088	0.8	W22TT	-	VW22	4
1.6	66	16 SV		09/84-08/91	W22EPR-U	3088	0.8	W22TT	-	VW22	4
ASTRAMAX (85-90)											
1.3	44	13 NB		09/85-06/90	W22EPR-U	3088	0.8	W22TT	-	VW22	4
BLITZ (69-87)											
2.0 D	44	20 DTr		10/80-10/83	DG-001		11V				4
2.1 D	44	21D		09/81-10/87	DG-012		11V				4
2.3 D	46	23D		01/73-10/87	DG-001		11V				4
MIDI (84-92)											
1.8	63	4FB1;4ZB1; 4FB1		09/84-05/88	W20EPR-U	3047	0.8	W20TT	IW20TT	IW20TT	4
2.0	62	4ZC1		06/88-08/92	W20EPR-U	3047	0.8	W20TT	IW20TT	IW20TT	4
2.0 4WD	62	4ZC1		06/88-08/92	W20EPR-U	3047	0.8	W20TT	IW20TT	IW20TT	4
2.0 D	42			08/84-05/88	DG-001		11V				4
2.2 D 4WD	45	4FD1		06/88-05/90	DG-159		5V				4
RASCAL (86-90)											
1.0	34	FA10A		06/86-06/90	K20TXR	5063	1.0	K20TT	IK20TT	IK20TT	4
1.0 All-wheel Drive	34	CB		07/86-06/90	K20TXR	5063	1.0	K20TT	IK20TT	IK20TT	3
BENTLEY											
ARNAGE (98-09)											
4.4 V8	260			04/98-10/09	K20TXR	5063	1.0	K20TT	IK20TT	IK20TT	8
BROOKLANDS (92-97)											
6.7 Long	177	L 410 I		10/92-09/97	IW16	5305	1.1	-	IW16TT	IW16TT	8
CONTINENTAL (84-95)											
6.7	158/ 160/ 166/ 176	L 410 A; L 410 I		07/84-09/89	W16EPR-U	3021	0.8	W16TT	IW16TT	IW16TT	8
CONTINENTAL (91-02)											
6.7 Turbo R	235	L 410 IT		10/91-09/95	W16EPR-U	3021	0.8	W16TT	IW16TT	IW16TT	8
6.75 V8 R	300	L 410 M1T2		08/99-10/02	IK20	5304	1.1	-	IK20TT	IK20TT	8
6.75 V8 R	265	L 410 IT		10/91-08/99	W20EPR-U	3047	0.8	W20TT	IW20TT	IW20TT	8
6.75 V8 S	286	L 410 M1T		05/94-12/95	IK16	5303	1.1	-	IK16TT	IK16TT	8
6.75 V8 T Mulliner	313	L 410 M1T3		08/99-10/02	IK20	5304	1.1	-	IK20TT	IK20TT	8

	KW					Standard			Twin Tip				QTY	
BENTLEY <i>continued</i>														
CONTINENTAL (03-)														
6.0	412/423/463	MTBHT		06/03-	PK20PR-P8	3245	0.8	-		IK20TT	IK20TT			12
6.0 All-wheel Drive	449	MTBHT		08/07-	PK20PR-P8	3245	0.8	-		IK20TT	IK20TT			12
CONTINENTAL Flying Spur (05-)														
6.0	412	MTBHT		03/05-	PK20PR-P8	3245	0.8	-		IK20TT	IK20TT			12
EIGHT (84-92)														
6.7	166	L 410 I		10/89-09/92	IW16	5305	1.1	-		IW16TT	IW16TT			8
MULSANNE (80-92)														
6.7 S	160	L 410 I		10/89-09/92	IW16	5305	1.1	-		IW16TT	IW16TT			8
TURBO R (88-98)														
6.7	286	L 410 IT; L 410 M1T		06/95-02/98	IK16	5303	1.1	-		IK16TT	IK16TT			8
6.7	235/287	L 410 IT		10/88-02/98	W16EPR-U	3021	0.8	W16TT		IW16TT	IW16TT			8
6.7 S	300			01/94-12/95	W20EPR-U	3047	0.8	W20TT		IW20TT	IW20TT			8
BERTONE														
FREECLIMBER (89-99)														
2.4 TD	85	BMW M 21 D 24		06/89-12/93	DG-001		11V							6
BMW														
1 (E81, E87) (03-12)														
3.0	190	N52 B30 A		03/05-07/05	VKH20	5618	1.1	-		IKH20TT	IKH20TT			6
116 i	85/90	N45 B16 A		11/03-09/12	K20TXR	5063	1.0	K20TT		IK20TT	IK20TT			4
118 d	90/100/105	M47 D20 (204D4)		11/03-09/12	DG-178		5V							4
118 i	95/100/105	N46 B20 B		09/06-09/12	VK20	5604	1.1	-		IK20TT	IK20TT			4
120 d	120/130	M47 D20 (204D4)		11/03-09/12	DG-178		5V							4
120 i	110/115/120/125	N46 B20 A; N46 B20 B; N46 B20 BD; N46 B20 C; N46 B20 CC		11/03-09/12	VK20	5604	1.1	-		IK20TT	IK20TT			4
130 i	190/195	N52 B30 A; N52 B30 AF; N52 B30 B; N52 B30 BF		03/05-12/09	VKH20	5618	1.1	-		IKH20TT	IKH20TT			6
1 (E82, E88) (07-)														
118 i	100	N46 B20 B		09/08-	VK20	5604	1.1	-		IK20TT	IK20TT			4
120 i	115/125	N46 B20 B; N46 B20 C		10/07-	VK20	5604	1.1	-		IK20TT	IK20TT			4
125 i	160	N52 B30 A		10/07-12/09	VKH20	5618	1.1	-		IKH20TT	IKH20TT			6
128 i	171	N51 B30 A		03/08-	VKH20	5618	1.1	-		IKH20TT	IKH20TT			6
1 (F20, F21) (10-)														
114 i	75	N13 B16 A		12/11-	IXUH22	5353	0.9	-	-			VXUH22		4
114 i	75	N13 B16 A		11/11-	VXUH22	5611	0.9	-	-			VXUH22		4
116 i	100	N13 B16 A		12/10-	IXUH22	5353	0.9	-	-			VXUH22		4
118 i	125	N13 B16 A		11/10-	IXUH22	5353	0.9	-	-			VXUH22		4
02 (E6, E10) (67-77)														
1502	55	M10 B16		01/75-07/77	W16EPR-U	3021	0.8	W16TT		IW16TT	IW16TT			4
1600	63	M10 B16		05/71-04/73	W16EPR-U	3021	0.8	W16TT		IW16TT	IW16TT			4
1600 Ti	77	M10 B16		09/67-11/69	W16EPR-U	3021	0.8	W16TT		IW16TT	IW16TT			4
1600/2	63	M10 B16		12/67-12/71	W16EPR-U	3021	0.8	W16TT		IW16TT	IW16TT			4
1600-2	63	M10 B16		12/67-10/71	W16EPR-U	3021	0.8	W16TT		IW16TT	IW16TT			4
1602	63	M10 B16		04/71-07/75	W16EPR-U	3021	0.8	W16TT		IW16TT	IW16TT			4
2002	74	M10 B20		02/68-07/75	W20EP-U	3043	0.8	W20TT		IW20TT	IW20TT			4
2002 Ti	88	M10 B20		06/68-04/72	W20EP-U	3043	0.8	W20TT		IW20TT	IW20TT			4
2002 Tii	96	M10 B20		01/71-07/75	W20EP-U	3043	0.8	W20TT		IW20TT	IW20TT			4
3 (E21) (75-84)														
315	55	M10 B16 (164VB)		03/81-03/84	W16EPR-U	3021	0.8	W16TT		IW16TT	IW16TT			4
316	66	M10 B16 (164VA)		08/75-08/80	W16EPR-U	3021	0.8	W16TT		IW16TT	IW16TT			4
316	66	M10 B18 (184VC)		09/80-08/82	W16EP-U	3018	0.8	W16TT		IW16TT	IW16TT			4
318	72	M10 B18 (184VA)		08/75-08/80	W16EP-U	3018	0.8	W16TT		IW16TT	IW16TT			4
318 i	77	M10 B18 (184VA)		11/79-08/82	W16EP-U	3018	0.8	W16TT		IW16TT	IW16TT			4
320	80	M10 B20		08/75-08/77	W16EPR-U	3021	0.8	W16TT		IW16TT	IW16TT			4
320 i	92	M10 B20		06/75-08/82	W20EPR-U	3047	0.8	W20TT		IW20TT	IW20TT			4
320/6	90	M20 B20 (206VA)		09/77-08/82	W16EPR-U	3021	0.8	W16TT		IW16TT	IW16TT			6
323 i	105	M20 B23 (236EA)		01/78-08/82	W16EP-U	3018	0.8	W16TT		IW16TT	IW16TT			6
3 (E30) (82-94)														
315	55	M10 B16		09/82-12/91	W16EPR-U	3021	0.8	W16TT		IW16TT	IW16TT			4
316	66	M10 B18 (184VC)		09/82-12/87	W16EP-U	3018	0.8	W16TT		IW16TT	IW16TT			4

	KW					Standard			Twin Tip			QTY
BMW continued												
3 (E30) (82-94) continued												
316 (Ecotronic)	66	M10 B18 (184VD)		09/83-07/88	W16EP-U	3018	0.8	W16TT	IW16TT	IW16TT		4
316 i	73	M40 B16 (164E1)		09/91-06/94	K16PR-U	3191	0.8	K16TT	IK16TT	IK16TT		4
316 i	73	M40 B16 (164E1)		09/87-06/91	K16R-U	3119	0.8	K16TT	IK16TT	IK16TT		4
316 i	75	M40 B16 (164E1)		07/88-06/94	K20TXR	5063	1.0	K20TT	IK20TT	IK20TT		4
316 i	75	M10 B18 (184KA)		08/87-08/88	W16EPR-U	3021	0.8	W16TT	IW16TT	IW16TT		4
318 i	83	M40 B18 (184E1)		04/89-06/94	K16PR-U	3191	0.8	K16TT	IK16TT	IK16TT		4
318 i	83/85	M40 B18 (184E1)		09/87-06/91	K16R-U	3119	0.8	K16TT	IK16TT	IK16TT		4
318 i	75/77	M10 B18 (184EA); M10 B18 (184KA)		09/82-08/88	W16EP-U	3018	0.8	W16TT	IW16TT	IW16TT		4
318 is	100	M42 B18 (184S1)		09/89-08/91	K20TXR	5063	1.0	K20TT	IK20TT	IK20TT		4
320 i	93/95	M20 B20 (206KA); M20 B20		12/85-10/93	J16CR-U	3256	0.8	W16TT	IW16TT	IW16TT		6
320 i	92	M20 B20 (206EB)		09/82-12/85	W16EPR-U	3021	0.8	W16TT	IW16TT	IW16TT		6
320 is	141	S14 B20 (204EA)		05/88-12/90	X22ESR-U	4091	0.7	-	-	-		4
323 i	102/ 110	M20 B23 (236EC)		09/82-08/86	W16EP-U	3018	0.8	W16TT	IW16TT	IW16TT		6
324 d	63	M21 D24 (246DA)		09/85-08/91	DG-001		11V					6
324 td	85	M21 D24 (246TB)		09/87-06/93	DG-001		11V					6
325 e 2.7	90/95	M20 B27 (276KA); M20 B27 (276KB)		10/83-12/88	J16CR-U	3256	0.8	W16TT	IW16TT	IW16TT		6
325 i	125	M20 B25 (256K1)		07/87-03/93	J16CR-U	3256	0.8	W16TT	IW16TT	IW16TT		6
325 i	125/ 126	M20 B25 (256E1); M20 B25 (256E2); M20 B25 (256EX); M20 B25 (256K1)		12/85-06/91	W20EPR-U	3047	0.8	W20TT	IW20TT	IW20TT		6
325 i X	125	M20 B25 (256E1); M20 B25 (256E2); M20 B25 (256EX); M20 B25 (256K1)		12/86-10/93	J16CR-U	3256	0.8	W16TT	IW16TT	IW16TT		6
325 i X	126	M20 B25 (256E1); M20 B25 (256E2); M20 B25 (256EX); M20 B25 (256K1)		03/86-12/87	W20EPR-U	3047	0.8	W20TT	IW20TT	IW20TT		6
M3 2.3	158	S14 B23 (234EA)		06/89-06/91	X22ESR-U	4091	0.7	-	-	-		4
M3 2.3	143/ 147	S14 B23 (234EA); S14 B23 (234S1); S14 B23 (234S2)		02/87-06/91	X24EP-U9	4093	0.9	-	-	-		4
M3 EVO I 2.3	162	S14 B23 (234EA)		10/88-10/90	X24EP-U9	4093	0.9	-	-	-		4
M3 EVO II 2.5	175	S14 B25 (254S1)		01/90-01/92	X24EP-U9	4093	0.9	-	-	-		4
3 (E36) (90-00)												
316 g	75	M43 B16 (164E2)		03/94-08/00	IK20	5304	1.1	-	IK20TT	IK20TT		4
316 i	73/ 75/ 77	M40 B16 (164E1); M43 B16 (164E2); M43 B19 (194E1)		09/90-08/00	K20TXR	5063	1.0	K20TT	IK20TT	IK20TT		4
318 i	83/85	M40 B18 (184E1); M43 B18 (184E2)		12/90-02/98	K20TXR	5063	1.0	K20TT	IK20TT	IK20TT		4
318 is	103	M42 B18 (184S1); M44 B19 (194S1)		03/92-04/99	K20TXR	5063	1.0	K20TT	IK20TT	IK20TT		4
318 tds	66	M41 D17 (174T1)		01/95-10/99	DG-001		11V					4
318 ti	103	M42 B18 (184S1); M44 B19 (194S1)		11/94-08/00	K20TXR	5063	1.0	K20TT	IK20TT	IK20TT		4
320 i	110	M50 B20 (206S1); M50 B20 (206S2); M52 B20 (206S3)		03/92-10/99	K20TXR	5063	1.0	K20TT	IK20TT	IK20TT		6
323 i	125	M52 B25 (256S3)		07/97-10/99	K20TXR	5063	1.0	K20TT	IK20TT	IK20TT		6
323 i 2.5	125	M52 B25 (256S3)		07/97-02/98	K20TXR	5063	1.0	K20TT	IK20TT	IK20TT		6
323 ti	125	M52 B25 (256S3)		08/97-08/00	K20TXR	5063	1.0	K20TT	IK20TT	IK20TT		6
325 i	141	M50 B25 (256S1); M50 B25 (256S2)		03/92-04/99	K20TXR	5063	1.0	K20TT	IK20TT	IK20TT		6
325 td	85	M51 D25 (256T1)		09/91-02/98	DG-001		11V					6
325 tds	105	M51 D25 (256T1)		05/93-10/99	DG-001		11V					6
328 i	142	M52 B28 (286S1)		01/95-04/99	K20TXR	5063	1.0	K20TT	IK20TT	IK20TT		6
M3 3.0	210/ 217	S50 B30 (306S1)		01/94-10/95	XU22EPR-U	3179	0.9	XU22TT	-	VXU22		6
M3 3.2	236	S50 B32 (326S1)		09/95-04/99	XU22EPR-U	3179	0.9	XU22TT	-	VXU22		6
3 (E46) (98-05)												
316 Ci	77/85	M43 B16 (164E3); N45 B16 A		04/00-	K20TXR	5063	1.0	K20TT	IK20TT	IK20TT		4
316 i	77/85	M43 B16 (164E3); M43 B19 (194E1); N40 B16 A; N40 B18 A; N45 B16 A		09/98-02/05	K20TXR	5063	1.0	K20TT	IK20TT	IK20TT		4







Spark & Glow Plugs

Application Tables

	KW				Standard 			Twin Tip 			QTY
BMW continued											
3 (E46) (98-05) continued											
316 i	85	N45 B16 A; N45 B18 A		09/03-02/05	VK20	5604	1.1	-	IK20TT	IK20TT	4
316 ti	77/85	N40 B16 A		06/02-02/05	K20TXR	5063	1.0	K20TT	IK20TT	IK20TT	4
316 ti	85	N42 B18 A; N45 B16 A; N46 B18 A		06/01-02/05	VK20	5604	1.1	-	IK20TT	IK20TT	4
318 Ci	87/105	M43 B19 (194E1); N42 B20 A		11/99-02/04	K20TXR	5063	1.0	K20TT	IK20TT	IK20TT	4
318 Ci	105/110	N46 B20 A; N46 B20 B		09/03-	VK20	5604	1.1	-	IK20TT	IK20TT	4
318 d	85	M47 D20 (204D1); M47 D20 (204D4)		03/02-02/05	DG-178		5V				4
318 i	85/87/105	M43 B19 (194E1); N42 B20 A		10/99-02/04	K20TXR	5063	1.0	K20TT	IK20TT	IK20TT	4
318 i	105	N46 B20 A		09/03-02/05	VK20	5604	1.1	-	IK20TT	IK20TT	4
318 td	85	M47 D20 (204D4)		03/03-02/05	DG-178		5V				4
318 ti	105	N42 B20 A		09/01-02/04	K20TXR	5063	1.0	K20TT	IK20TT	IK20TT	4
318 ti	105	N46 B20 A		09/03-02/05	VK20	5604	1.1	-	IK20TT	IK20TT	4
320 Cd	110	M47 D20 (204D4)		11/03-	DG-178		5V				4
320 Ci	110/120/125	M52 B20 (206S4); M54 B22 (226S1)		08/99-	K20TXR	5063	1.0	K20TT	IK20TT	IK20TT	6
320 d	95/100	M47 D20 (204D1)		02/98-04/05	DG-145		11V				4
320 d	110	M47 D20 (204D4)		09/01-02/05	DG-178		5V				4
320 i	110/125	M52 B20 (206S4); M54 B22 (226S1)		03/98-02/05	K20TXR	5063	1.0	K20TT	IK20TT	IK20TT	6
320 td	100	M47 204 D1		10/01-12/02	DG-145		11V				4
320 td	110	M47 D20 (204D4)		09/01-02/05	DG-178		5V				4
323 Ci	125	M52 B25 (256S4)		04/99-09/00	K20TXR	5063	1.0	K20TT	IK20TT	IK20TT	6
323 i	125	M52 B25 (256S4)		03/98-09/00	K20TXR	5063	1.0	K20TT	IK20TT	IK20TT	6
325 Ci	141	M54 B25 (256S5)		09/00-	K20TXR	5063	1.0	K20TT	IK20TT	IK20TT	6
325 i	141	M54 B25 (256S5)		09/00-02/05	K20TXR	5063	1.0	K20TT	IK20TT	IK20TT	6
325 ti	141	M54 B25 (256S5)		06/01-02/05	K20TXR	5063	1.0	K20TT	IK20TT	IK20TT	6
325 xi	141	M54 B25 (256S5)		09/00-02/05	K20TXR	5063	1.0	K20TT	IK20TT	IK20TT	6
328 Ci	142	M52 B28 (286S2)		04/99-06/00	K20TXR	5063	1.0	K20TT	IK20TT	IK20TT	6
328 i	142	M52 B28 (286S2)		02/98-06/00	K20TXR	5063	1.0	K20TT	IK20TT	IK20TT	6
330 Cd	150	M57 D30 (306D2)		03/03-	DG-178		5V				6
330 Ci	170	M54 B30 (306S3)		06/00-	K20TXR	5063	1.0	K20TT	IK20TT	IK20TT	6
330 d	135	M57 D30 (306D1)		10/99-02/05	DG-145		11V				6
330 d	150	M57 D30 (306D2)		03/03-02/05	DG-178		5V				6
330 i	170	M54 B30 (306S3)		06/00-02/05	K20TXR	5063	1.0	K20TT	IK20TT	IK20TT	6
330 xd	135	M57 D30 (306D1)		06/00-02/05	DG-145		11V				6
330 xd	150	M57 D30 (306D2)		03/03-02/05	DG-178		5V				6
330 xi	170	M54 B30 (306S3)		06/00-	K20TXR	5063	1.0	K20TT	IK20TT	IK20TT	6
M3 3.2	252	S54 B32 (326S4)		06/00-	VXU24	5609	0.9	-	-	VXU24	6
M3 CSL	265	S54 B32 (326S4)		06/03-	VXU24	5609	0.9	-	-	VXU24	6
3 (E90, E91) (05-)											
316 i	85	N45 B16 A		02/06-12/11	K20TXR	5063	1.0	K20TT	IK20TT	IK20TT	4
318 d	90	M47 D20 (204D4)		09/05-	DG-178		5V				4
318 i	95/100	N46 B20 B		09/05-12/11	VK20	5604	1.1	-	IK20TT	IK20TT	4
320 d	110/120	M47 D20 (204D4); M47N 204 D5		09/05-	DG-178		5V				4
320 i	110/115	N46 B20 A; N46 B20 B; N46 B20 C		01/05-12/11	VK20	5604	1.1	-	IK20TT	IK20TT	4
320 si	127	N45 B20 A		05/06-12/11	K20TXR	5063	1.0	K20TT	IK20TT	IK20TT	4
323 i	130/140	N52 B25 A; N52N B25 A		04/06-07/08	VKH20	5618	1.1	-	IKH20TT	IKH20TT	6
325 d	145	M57 D30 (306D3)		09/06-	DG-178		5V				6
325 i	155/160	N52 B25 A		09/05-12/09	VKH20	5618	1.1	-	IKH20TT	IKH20TT	6
325 xi	160	N52 B25 A		01/05-12/09	VKH20	5618	1.1	-	IKH20TT	IKH20TT	6
328 i	187	N52N B30 A		07/05-11/07	VKH20	5618	1.1	-	IKH20TT	IKH20TT	6
330 d	170	M57 D30 (306D3)		09/05-	DG-178		5V				6
330 i	190/200	N52 B30 A		01/05-12/09	VKH20	5618	1.1	-	IKH20TT	IKH20TT	6
330 xd	170	M57 D30 (306D3)		09/05-	DG-178		5V				6
330 xi	190	N52 B30 A		01/05-12/09	VKH20	5618	1.1	-	IKH20TT	IKH20TT	6
335 d	210	M57 D30 (306D5)		09/06-	DG-178		5V				6



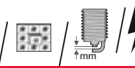



Spark & Glow Plugs





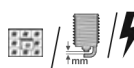

Application Tables

	KW								QTY		
BMW <i>continued</i>											
3 (E92, E93) (06-)											
320 i	110/115	N46 B20 A; N46 B20 B; N46 B20; N46N B20 B		11/06-	VK20	5604	1.1	-	IK20TT	IK20TT	4
323 i	130	N52N B25 A		06/06-12/09	VKH20	5618	1.1	-	IKH20TT	IKH20TT	6
325 d	145	M57 D30 (306D3)		03/07-	DG-178		5V				6
325 i	160	N52 B25 A		09/06-12/09	VKH20	5618	1.1	-	IKH20TT	IKH20TT	6
325 xi	160	N52 B25 A		09/06-12/09	VKH20	5618	1.1	-	IKH20TT	IKH20TT	6
328 i	187	N52N B30 A		08/06-11/07	VKH20	5618	1.1	-	IKH20TT	IKH20TT	6
330 d	170	M57 D30 (306D3)		09/06-	DG-178		5V				6
330 i	190/200	N52 B30 A; N52N B30 B		09/06-12/09	VKH20	5618	1.1	-	IKH20TT	IKH20TT	6
330 xd	170	M57 D30 (306D3)		09/06-	DG-178		5V				6
330 xi	190/200	N52 B30 A		09/06-12/09	VKH20	5618	1.1	-	IKH20TT	IKH20TT	6
335 d	210	M57 D30 (306D5)		09/06-	DG-178		5V				6
3 (F30, F31) (11-)											
316 i	100	N13 B16 A		10/12-	IXUH22	5353	0.9	-	-	VXUH22	4
320 i	125	N13 B16 A		02/12-	IXUH22	5353	0.9	-	-	VXUH22	4
5 (E12) (72-81)											
518	66/80	M10 B18 (184VB); M10 B20		07/74-05/81	W16EP-U	3018	0.8	W16TT	IW16TT	IW16TT	4
518 i	92	M10 B20		08/77-09/79	W16EP-U	3018	0.8	W16TT	IW16TT	IW16TT	4
520	85	M10 B20		07/75-08/77	W16EP-U	3018	0.8	W16TT	IW16TT	IW16TT	4
520	85	M10 B20		08/72-07/75	W20EP-U	3043	0.8	W20TT	IW20TT	IW20TT	4
520 i	92/96	M10 B20		07/75-05/77	W16EP-U	3018	0.8	W16TT	IW16TT	IW16TT	4
520 i	96	M10 B20		08/72-07/75	W20EP-U	3043	0.8	W20TT	IW20TT	IW20TT	4
520/6	90	M20 B20 (206VA)		09/77-05/81	J16CR-U	3256	0.8	W16TT	IW16TT	IW16TT	6
525	107	M30 B25		08/73-10/76	W16EP-U	3018	0.8	W16TT	IW16TT	IW16TT	6
525	110	M30 B25 (256VA)		08/76-05/81	W20EP-U	3043	0.8	W20TT	IW20TT	IW20TT	6
528 i	135	M30 B28		08/79-05/81	W16EP-U	3018	0.8	W16TT	IW16TT	IW16TT	6
M 3.4	160	M30 B35 (Motronic,9.3:1)		06/80-08/81	W20EP-U	3043	0.8	W20TT	IW20TT	IW20TT	6
5 (E28) (81-87)											
518	66	M10 B18 (184VC); M10 B18 (184VD)		06/81-08/84	W16EP-U	3018	0.8	W16TT	IW16TT	IW16TT	4
518 i	75/77	M10 B18 (184EB)		09/81-12/87	W16EP-U	3018	0.8	W16TT	IW16TT	IW16TT	4
520 i	92	M20 B20 (206EA)		06/81-12/87	J16CR-U	3256	0.8	W16TT	IW16TT	IW16TT	6
520 i	110			12/86-12/87	K20TXR	5063	1.0	K20TT	IK20TT	IK20TT	6
520 i	95	M20 B20 (206KA)		09/86-12/87	W16EP-U	3018	0.8	W16TT	IW16TT	IW16TT	6
524 d	63	M21 D24 (246DA)		03/86-12/87	DG-001		11V				6
524 td	85	M21 D24 (246TA)		09/83-12/87	DG-001		11V				6
525 e	90/92/95	M20 B27 (276EA); M20 B27 (276EB); M20 B27 (276KA); M20 B27 (276KB)		09/81-12/87	J16CR-U	3256	0.8	W16TT	IW16TT	IW16TT	6
525 i	110	M30 B25 (256EA)		06/81-12/87	W16EP-U	3018	0.8	W16TT	IW16TT	IW16TT	6
528 i	135	M30 B28 (286EA)		06/81-12/87	W16EP-U	3018	0.8	W16TT	IW16TT	IW16TT	6
535 i, M 535 i	136/141/160	M30 B34 (346EC); M30 B34 (346KA); M30 B35 (Motronic)		01/85-12/87	J16CR-U	3256	0.8	W16TT	IW16TT	IW16TT	6
M 3.5	211	S38 B35 (356ED)		08/85-12/87	IX22B	5375	0.9	-	-	-	6
5 (E34) (87-97)											
518 i	83/85	M40 B18 (184E1); M43 B18 (184E2)		08/89-01/97	K20TXR	5063	1.0	K20TT	IK20TT	IK20TT	4
520 i	95	M20 B20 (206KA)		01/88-08/91	J16CR-U	3256	0.8	W16TT	IW16TT	IW16TT	6
520 i	110	M50 B20 (206S1); M50 B20 (206S2)		11/91-01/97	K20TXR	5063	1.0	K20TT	IK20TT	IK20TT	6
520 i 24V	110	M50 B20 (206S1); M50 B20 (206S2)		09/89-09/95	K20TXR	5063	1.0	K20TT	IK20TT	IK20TT	6
524 td	85	M21 D24 (246TB)		03/88-09/95	DG-001		11V				6
525 i	141	M50 B25 (256S1); M50 B25 (256S2)		11/91-01/97	K20TXR	5063	1.0	K20TT	IK20TT	IK20TT	6
525 i	125	M20 B25 (256K1)		01/88-08/91	W20EPR-U	3047	0.8	W20TT	IW20TT	IW20TT	6
525 i 24V	141	M50 B25 (256S2)		09/89-09/95	K20TXR	5063	1.0	K20TT	IK20TT	IK20TT	6
525 ix	141	M50 B25 (256S1); M50 B25 (256S2)		02/92-01/97	K20TXR	5063	1.0	K20TT	IK20TT	IK20TT	6
525 iX 24V	141	M50 B25 (256S1); M50 B25 (256S2)		10/91-09/95	K20TXR	5063	1.0	K20TT	IK20TT	IK20TT	6
525 td	85	M51 D25 (256T1)		03/93-01/97	DG-001		11V				6
525 tds	105	M51 D25 (256T1)		09/91-01/97	DG-001		11V				6
530 i	138	M30 B30 (306KA)		01/88-08/91	J16CR-U	3256	0.8	W16TT	IW16TT	IW16TT	6

Spark & Glow Plugs







Application Tables







	KW								QTY	
BMW continued										
5 (E34) (87-97) continued										
530 i V8	160	M60 B30 (308S1)		09/92-01/97	K20TXR	5063 1.0	K20TT	IK20TT	IK20TT	8
535 i	155	M30 B34 (346KB)		01/88-09/95	J16CR-U	3256 0.8	W16TT	IW16TT	IW16TT	6
540 i	210	M60 B40 (408S1)		09/93-01/97	K20TXR	5063 1.0	K20TT	IK20TT	IK20TT	8
540 i V8	210	M60 B40 (408S1)		09/92-09/95	K20TXR	5063 1.0	K20TT	IK20TT	IK20TT	8
M 3.6	232	S38 B36 (366S1)		10/88-05/92	XU20EPR-U	3178 0.9	-	-	VXU22	6
M 3.6 CAT	232	S38 B36 (366S1)		10/88-05/92	XU20EPR-U	3178 0.9	-	-	VXU22	6
M 3.8	250	S38 B38 (386S1)		03/92-01/97	XU22EPR-U	3179 0.9	XU22TT	-	VXU22	6
5 (E39) (95-04)										
520 d	100	M47 D20 (204D1)		02/00-09/03	DG-145		11V			4
520 i	100/ 110/ 125	M52 B20 (206S3); M54 B22 (226S1)		04/99-05/04	K20TXR	5063 1.0	K20TT	IK20TT	IK20TT	6
523 i	125	M52 B25 (256S3)		11/95-09/00	K20TXR	5063 1.0	K20TT	IK20TT	IK20TT	6
525 d	120	M57 D25 (256D1)		02/00-05/04	DG-145		11V			6
525 i	141	M54 B25 (256S5)		09/00-05/04	K20TXR	5063 1.0	K20TT	IK20TT	IK20TT	6
525 td	85	M51 D25 (256T1)		01/97-06/03	DG-001		11V			6
525 tds	105	M51 D25 (256T1)		01/96-05/04	DG-001		11V			6
528 i	142	M52 B28 (286S1); M52 B28 (286S2)		11/95-09/00	K20TXR	5063 1.0	K20TT	IK20TT	IK20TT	6
530 d	142	M57 D30 (306D1)		09/00-05/04	DG-001		11V			6
530 d	135/ 142	M57 D30 (306D1)		08/98-06/03	DG-145		11V			6
530 i	170	M54 B30 (306S3)		09/00-05/04	K20TXR	5063 1.0	K20TT	IK20TT	IK20TT	6
535 i	173/ 180	M62 B35 (358S1); M62 B35 (358S2)		04/96-06/03	K20TXR	5063 1.0	K20TT	IK20TT	IK20TT	8
540 i	210	M62 B44 (448S1); M62 B44 (448S2)		04/96-05/04	K20TXR	5063 1.0	K20TT	IK20TT	IK20TT	8
M 4.9	294	S62 B50 (508S1)		10/98-06/03	K20TXR	5063 1.0	K20TT	IK20TT	IK20TT	8
5 (E60, E61) (03-10)										
520 d	110/ 120/ 130	M47 D20 (204D4)		09/05-	DG-178		5V			4
520 i	125	M54 B22 (226S1)		07/03-03/10	K20TXR	5063 1.0	K20TT	IK20TT	IK20TT	6
520 i	115	N46 B20 B		04/06-12/09	VK20	5604 1.1	-	IK20TT	IK20TT	6
523 i	130/ 140	N52 B25 A		07/05-12/09	VKH20	5618 1.1	-	IKH20TT	IKH20TT	6
525 d	120/ 130/ 145	M57 D25 (256D1); M57 D25 (256D2); M57 D30 (306D3); M57N 256 D4		12/04-03/10	DG-178		5V			6
525 d xDrive	145	M57 D30 (306D3)		09/08-	DG-178		5V			6
525 i	141	M54 B25 (256S5)		09/03-	K20TXR	5063 1.0	K20TT	IK20TT	IK20TT	6
525 i	160	N52 B25 A		07/05-12/09	VKH20	5618 1.1	-	IKH20TT	IKH20TT	6
525 xd	145	M57 D30 (306D3)		01/07-	DG-178		5V			6
525 xi	160	N52 B25 A; N52 B30 A		07/05-12/09	VKH20	5618 1.1	-	IKH20TT	IKH20TT	6
530 d	155/ 160/ 170/ 173	M57 D30 (306D2); M57 D30 (306D3)		07/03-03/10	DG-178		5V			6
530 d xDrive	173	M57 D30 (306D3)		09/08-	DG-178		5V			6
530 i	170	M54 306 S3; M54 B30 (306S3)		07/03-	K20TXR	5063 1.0	K20TT	IK20TT	IK20TT	6
530 i	187/ 190/ 200	N52 B30 A		03/05-12/09	VKH20	5618 1.1	-	IKH20TT	IKH20TT	6
530 i xDrive	200	N52 B30 A		09/08-12/09	VKH20	5618 1.1	-	IKH20TT	IKH20TT	6
530 xd	170/ 173	M57 D30 (306D3)		07/05-	DG-178		5V			6
530 xi	190/ 200	N52 B30 A		07/05-12/09	VKH20	5618 1.1	-	IKH20TT	IKH20TT	6
535 d	200/ 210	M57 D30 (306D4); M57 D30 (306D5)		09/04-	DG-178		5V			6
540 i	225	N54 B30 A; N62 B40 A		07/05-03/10	VK20	5604 1.1	-	IK20TT	IK20TT	8
545 i	245	N62 B44 A		09/03-	K20TXR	5063 1.0	K20TT	IK20TT	IK20TT	8
550 i	270	N62 B48 A; N62 B48 B		07/05-	VK20	5604 1.1	-	IK20TT	IK20TT	8
6 (E24) (76-90)										
628 CSi	135	M30 B28		09/79-08/87	W16EPR-U	3021 0.8	W16TT	IW16TT	IW16TT	6
630 CS	136	M30 B30		04/76-08/79	W16EPR-U	3021 0.8	W16TT	IW16TT	IW16TT	6
633 CSi	145	M30 B32		09/78-08/84	W16EP-U	3018 0.8	W16TT	IW16TT	IW16TT	6
635 CSi	136/ 155	M30 B34 (346KA); M30 B34 (346KB)		06/86-05/89	J16CR-U	3256 0.8	W16TT	IW16TT	IW16TT	6

	KW					Standard		Twin Tip		QTY	
BMW continued											
6 (E24) (76-90) continued											
635 CSi	160	M30 B35 (L-Jetronic,10:1); M30 B35 (Motronic,10:1); M30 B35 (Motronic,9.3:1)		06/78-03/82	W16EP-U	3018	0.8	W16TT	IW16TT	IW16TT	6
6 (E63, E64) (04-)											
630 i	190/200	N52 B30 A; N52 B30 B; N52 B30 BF; N53 B30 A		09/04-12/09	VKH20	5618	1.1	-	IKH20TT	IKH20TT	6
635 d	210	M57 D30 (306D5)		07/07-	DG-178		5V				6
645 Ci	245	N62 B44 A		01/04-	K20TXR	5063	1.0	K20TT	IK20TT	IK20TT	8
650 i	270	N62 B48 B		07/05-	VK20	5604	1.1	-	IK20TT	IK20TT	8
7 (E23) (77-86)											
725 i	110	M30 B25		09/81-06/86	W16EPR-U	3021	0.8	W16TT	IW16TT	IW16TT	6
728 i	135	M30 B28		07/78-08/86	W16EPR-U	3021	0.8	W16TT	IW16TT	IW16TT	6
730	135	M30 B30		05/77-08/79	W16EPR-U	3021	0.8	W16TT	IW16TT	IW16TT	6
732 i	145	M30 B32		09/79-08/86	W16EPR-U	3021	0.8	W16TT	IW16TT	IW16TT	6
733 i	145	M30 B32		05/77-08/86	W16EPR-U	3021	0.8	W16TT	IW16TT	IW16TT	6
735 i	136/160	M30 B34 (346EC); M30 B34 (346KA); M30 B35 (Motronic,10:1); M30 B35 (Motronic,9.3:1)		09/79-08/86	W16EPR-U	3021	0.8	W16TT	IW16TT	IW16TT	6
745 i	185	M30 B32 (326TA); M30 B35		04/80-08/86	W16EPR-U	3021	0.8	W16TT	IW16TT	IW16TT	6
7 (E32) (86-94)											
730 i,iL	138/145	M30 B30 (306EA); M30 B30 (306KA)		12/86-09/94	J16CR-U	3256	0.8	W16TT	IW16TT	IW16TT	6
730 i,iL V8	160	M60 B30 (308S1)		04/92-09/94	K20TXR	5063	1.0	K20TT	IK20TT	IK20TT	8
735 i,iL	155/162	M30 B34 (346KB); M30 B35 (Motronic,9.2:1)		09/86-09/92	J16CR-U	3256	0.8	W16TT	IW16TT	IW16TT	6
740 i,iL V8	210	M60 B40 (408S1)		04/92-09/94	K20TXR	5063	1.0	K20TT	IK20TT	IK20TT	8
750 i,iL V12	220	M70 B50 (5012A)		09/87-09/94	K16R-U	3119	0.8	K16TT	IK16TT	IK16TT	12
7 (E38) (94-01)											
725 tds	105	M51 D25 (256T1)		04/96-11/01	DG-001		11V				6
728 i,iL	142	M52 B28 (286S1); M52 B28 (286S2)		08/95-11/01	K20TXR	5063	1.0	K20TT	IK20TT	IK20TT	6
728i X	142	M52 B28 (286S1)		11/95-09/01	K20TXR	5063	1.0	K20TT	IK20TT	IK20TT	6
730 d	135/142	M57 D30 (306D1)		08/98-11/01	DG-145		11V				6
730 i,iL	155/160	M60 B30 (308S1)		10/94-11/01	K20TXR	5063	1.0	K20TT	IK20TT	IK20TT	8
735 i,iL	173	M62 B35 (358S1)		01/96-11/01	K20TXR	5063	1.0	K20TT	IK20TT	IK20TT	8
740 i,iL	210	M60 B40 (408S1); M62 B44 (448S1); M62 B44 (448S2)		10/94-11/01	K20TXR	5063	1.0	K20TT	IK20TT	IK20TT	8
750 i,iL	240	M73 B54 (54121); M73 B54 (54122)		12/94-11/01	KJ14CR-L11	3167	1.1	-	-	VK16	12
7 (E65, E66) (01-)											
3.0 730 i, Li	184	N52 B30 A		03/05-12/09	VKH20	5618	1.1	-	IKH20TT	IKH20TT	6
730 d	155	M57 D30 (306D3)		10/02-11/06	DG-145		11V				6
730 d	160	M57 D30 (306D2)		10/02-	DG-178		5V				6
730 i,Li	170	M54 B30 (306S3)		03/03-	K20TXR	5063	1.0	K20TT	IK20TT	IK20TT	6
730 i,Li	190	N52 B30 A		03/05-12/09	VKH20	5618	1.1	-	IKH20TT	IKH20TT	6
730 Ld	170	M57 D30 (306D3)		07/05-10/08	DG-178		5V				6
735 i	225	N62 B40 A		03/05-	VK20	5604	1.1	-	IK20TT	IK20TT	8
735 i,Li	200	N62 B36 A		11/01-	K20TXR	5063	1.0	K20TT	IK20TT	IK20TT	8
740 d	190	M67 D39 (398D1)		10/02-	DG-191		5V				8
740 i,Li	225	N62 B40 A		07/05-	VK20	5604	1.1	-	IK20TT	IK20TT	8
745 d	220/242	M67 D44 (448D1)		03/05-	DG-191		5V				8
745 i,Li	245	N62 B44 A		11/01-	K20TXR	5063	1.0	K20TT	IK20TT	IK20TT	8
750 i,Li	270	N62 B48 B		07/05-	VK20	5604	1.1	-	IK20TT	IK20TT	8
760 i,Li	327	N73 B60 A		01/03-10/08	K20TXR	5063	1.0	K20TT	IK20TT	IK20TT	12
7 (F01, F02, F03, F04) (08-)											
730 i	190	N52 B30 A; N52 B30 BF		06/08-12/09	VKH20	5618	1.1	-	IKH20TT	IKH20TT	6
8 (E31) (90-99)											
840 Ci	210	M62 B44 (448S1)		01/96-12/99	K20TXR	5063	1.0	K20TT	IK20TT	IK20TT	8
840 i	210	M60 B40 (408S1)		02/93-02/96	K20TXR	5063	1.0	K20TT	IK20TT	IK20TT	8
850 Ci	240	M73 B54 (54121)		09/94-12/99	KJ14CR-L11	3167	1.1	-	-	VK16	12

Spark & Glow Plugs



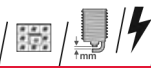



Application Tables







	KW					Standard			Twin Tip				QTY	
BMW continued														
8 (E31) (90-99) continued														
850 CSi	280	S70B56		04/93-12/96	KJ16CR-L11	3132	1.1		K16TT	IK16TT	IK16TT		12	
850 CSi	280	S70B56	OEM Optional	04/93-12/96	K20TXR	5063	1.0		K20TT	IK20TT	IK20TT		12	
850 i,Ci	220	M70 B50 (5012A)		04/90-10/94	KJ16CR-L11	3132	1.1		K16TT	IK16TT	IK16TT		12	
1500-2000 (62-72)														
1500	59	M10 B16		09/63-07/66	W16EPR-U	3021	0.8		W16TT	IW16TT	IW16TT		4	
1600	61	M10 B16		04/64-04/68	W16EPR-U	3021	0.8		W16TT	IW16TT	IW16TT		4	
2000	74	M10 B20		09/68-07/72	W20EP-U	3043	0.8		W20TT	IW20TT	IW20TT		4	
2000 Ti / Tilux	88	M10 B20		01/66-07/72	W20EP-U	3043	0.8		W20TT	IW20TT	IW20TT		4	
2000 Ti	96	M10 B20		12/69-07/72	W20EP-U	3043	0.8		W20TT	IW20TT	IW20TT		4	
1600 GT (67-69)														
1.6	77	M10 B16		10/67-05/69	W16EPR-U	3021	0.8		W16TT	IW16TT	IW16TT		4	
2000 (E9) (65-76)														
2000 C/CA	74	M10 B20		10/65-06/70	W20EP-U	3043	0.8		W20TT	IW20TT	IW20TT		4	
2000 CS	88	M10 B20		10/65-06/70	W20EP-U	3043	0.8		W20TT	IW20TT	IW20TT		4	
M1 (79-83)														
3.5	204	M88 B35		05/79-05/83	IX24	5372	0.8		-	-	-		6	
X1 (E84) (09-)														
sDrive 18 i	100/ 110	N46 B20 B		03/09-	VK20	5604	1.1		-	IK20TT	IK20TT		4	
xDrive 28 i	190	N52 B30 A		10/09-12/09	VKH20	5618	1.1		-	IKH20TT	IKH20TT		6	
X3 (E83) (04-)														
2.0 d	110	M47 D20 (204D4)		10/04-	DG-178		5V						4	
2.0 i	110	N46 B20 B		07/05-	VK20	5604	1.1		-	IK20TT	IK20TT		4	
2.5 i	141	M54 B25 (256S5)		01/04-	K20TXR	5063	1.0		K20TT	IK20TT	IK20TT		6	
2.5 si	160	N52 B25 A		09/06-12/09	VKH20	5618	1.1		-	IKH20TT	IKH20TT		6	
2.5 si xDrive	155	N52 B25 A		07/06-12/08	VKH20	5618	1.1		-	IKH20TT	IKH20TT		6	
3.0 d	150/ 160	M57 D30 (306D2); M57 D30 (306D3)		01/04-	DG-178		5V						6	
3.0 i xDrive	170	M54 B30 (306S3)		01/04-	K20TXR	5063	1.0		K20TT	IK20TT	IK20TT		6	
3.0 sd	210	M57 D30 (306D5)		09/06-	DG-178		5V						6	
3.0 si	200	N52 B30 A		09/06-12/09	VKH20	5618	1.1		-	IKH20TT	IKH20TT		6	
xDrive 20 i	110	N46 B20 B		09/08-	VK20	5604	1.1		-	IK20TT	IK20TT		4	
xDrive 25 i	160	N52 B25 A		09/08-12/09	VKH20	5618	1.1		-	IKH20TT	IKH20TT		6	
xDrive 30 d	155/ 160	M57 D30 (306D3)		09/08-03/10	DG-178		5V						6	
xDrive 30 i	200	N52 B30 A		09/08-12/09	VKH20	5618	1.1		-	IKH20TT	IKH20TT		6	
xDrive 35 d	210	M57 D30 (306D5)		09/08-08/10	DG-178		5V						6	
X5 (E53) (00-)														
3.0 d	135/ 155	M57 D30 (306D1); M57 D30 (306D2)		05/01-	DG-145		11V						6	
3.0 d	160	M57 D30 (306D2)		12/03-	DG-178		5V						6	
3.0 i	163/ 170	M54 B30 (306S3)		05/00-	K20TXR	5063	1.0		K20TT	IK20TT	IK20TT		6	
4.4 i	210/ 235	M62 B44 (448S2); N62 B44 A; N62 B44		05/00-	K20TXR	5063	1.0		K20TT	IK20TT	IK20TT		8	
4.6 is	255	M62 B46 (468S1)		02/02-11/06	K20TXR	5063	1.0		K20TT	IK20TT	IK20TT		8	
4.8 is	265	N62 B48 A		04/04-	VK20	5604	1.1		-	IK20TT	IK20TT		8	
X5 (E70) (07-13)														
3.0 d	155/ 173	M57 D30 (306D3)		02/07-09/08	DG-178		5V						6	
3.0 sd	210	M57 D30 (306D5)		09/07-02/09	DG-178		5V						6	
3.0 si	200	N52 B30 A		02/07-09/08	VKH20	5618	1.1		-	IKH20TT	IKH20TT		6	
4.8 i xDrive	261	N62 B48 B		02/07-09/08	VK20	5604	1.1		-	IK20TT	IK20TT		8	
xDrive 30 d	173	N57 D30 A		09/08-03/10	DG-178		5V						6	
xDrive 30 i	200	N52 B30 A		09/08-12/09	VKH20	5618	1.1		-	IKH20TT	IKH20TT		6	
xDrive 35 d	210	M57 D30 (306D5)		09/08-03/10	DG-178		5V						6	
xDrive 48 i	261	N62 B48 B		09/08-06/13	VK20	5604	1.1		-	IK20TT	IK20TT		8	
X6 (E71, E72) (08-)														
30 d	173	M57 D30 (306D3)		05/08-03/10	DG-178		5V						6	
35 d	210	M57 D30 (306D5)		05/08-03/10	DG-178		5V						6	
xDrive 35 d	210	M57 D30 (306D5)		09/08-03/10	DG-178		5V						6	
Z1 (88-91)														
2.5	125	M20 B25 (256K1)		06/88-06/91	J16CR-U	3256	0.8		W16TT	IW16TT	IW16TT		6	
Z3 (E36) (95-03)														
1.8	85	M43 B18 (184E2)		10/95-10/98	K20TXR	5063	1.0		K20TT	IK20TT	IK20TT		4	
1.9	85/ 87/ 103	M43 B19 (194E1); M44 B19 (194S1)		10/95-01/03	K20TXR	5063	1.0		K20TT	IK20TT	IK20TT		4	
2.0	110	M52 B20 (206S4)		04/99-10/00	K20TXR	5063	1.0		K20TT	IK20TT	IK20TT		6	
2.2	125	M54 B22 (226S1)		08/00-01/03	K20TXR	5063	1.0		K20TT	IK20TT	IK20TT		6	

	KW								QTY		
BMW <i>continued</i>											
Z3 (E36) (95-03) <i>continued</i>											
2.8	141	M52 B28 (286S1)		04/97-06/00	K20TXR	5063	1.0	K20TT	IK20TT	IK20TT	6
3.0	170	M54 B30 (306S3)		06/00-06/03	K20TXR	5063	1.0	K20TT	IK20TT	IK20TT	6
M	236/ 252	S50 326 S4; S50 B32 (326S1)		02/98-06/03	VXU22	5608	0.9	-	-	VXU22	6
M	239	S54 B32 (326S4)		06/01-05/02	VXU24	5609	0.9	-	-	VXU24	6
M 3.2	236/ 252	S50 326 S4; S50 B32 (326S1)		03/97-06/01	VXU22	5608	0.9	-	-	VXU22	6
M 3.2	239	S54 B32 (326S4)		06/01-01/03	VXU24	5609	0.9	-	-	VXU24	6
Z4 (E85, E86) (03-)											
2.0 i	110	N46 B20 A; N46 B20 B		04/05-	VK20	5604	1.1	-	IK20TT	IK20TT	4
2.2 i	125	M54 B22 (226S1)		10/03-	K20TXR	5063	1.0	K20TT	IK20TT	IK20TT	6
2.5 i	141	M54 B25 (256S5)		02/03-	K20TXR	5063	1.0	K20TT	IK20TT	IK20TT	6
2.5 i	130	N52 B25 A		01/06-12/09	VKH20	5618	1.1	-	IKH20TT	IKH20TT	6
2.5 si	160	N52 B25 A		01/06-12/09	VKH20	5618	1.1	-	IKH20TT	IKH20TT	6
3.0 i	170	M54 B30 (306S3)		02/03-	K20TXR	5063	1.0	K20TT	IK20TT	IK20TT	6
3.0 si	195	N52 B30 A		01/06-12/09	VKH20	5618	1.1	-	IKH20TT	IKH20TT	6
M	252	S54 B32 (326S4)		03/06-08/08	VXU24	5609	0.9	-	-	VXU24	6
Z4 (E89) (09-)											
sDrive 23 i	150	N52 B25 A		05/09-12/09	VKH20	5618	1.1	-	IKH20TT	IKH20TT	6
sDrive 30 i	190	N52 B30 A		05/09-12/09	VKH20	5618	1.1	-	IKH20TT	IKH20TT	6
Z8 (E52) (00-03)											
4.9	294	S62 B50		06/00-06/03	K20TXR	5063	1.0	K20TT	IK20TT	IK20TT	8
BUICK											
LE SABRE (85-91)											
3.8	121	LN3		10/87-09/91	T16EPR-U15	5023	1.5	T16TT	IT16TT	IT16TT	6
LE SABRE (91-95)											
3.8	127	L27		10/91-09/95	T16EPR-U15	5023	1.5	T16TT	IT16TT	IT16TT	6
PARK AVENUE (90-96)											
3.8	127	L27		01/91-10/96	T16EPR-U15	5023	1.5	T16TT	IT16TT	IT16TT	6
SKYLARK (94-99)											
2.4	112	LD9		01/95-12/99	T16EPR-U15	5023	1.5	T16TT	IT16TT	IT16TT	4
BYD											
F3 (05-)											
1.6	74	4G18		09/05-12/10	K20PR-U11	3121	1.1	K20TT	IK20TT	IK20TT	4
F3R (07-)											
1.6	74	4G18		09/07-	K20PR-U11	3121	1.1	K20TT	IK20TT	IK20TT	4
M6 (10-)											
2.4	118	4 G 69		07/10-	IKH20	5344	1.1	-	IKH20TT	IKH20TT	4
CADILLAC											
ALLANTE (88-93)											
4.5	150	LQ6		10/88-09/92	T16EPR-U15	5023	1.5	T16TT	IT16TT	IT16TT	8
4.6	220	L37		10/92-09/93	PT16EPR-L13	5070	1.3	-	IT16TT	IT16TT	8
BLS (06-)											
1.9 D	110	Z19DTH		04/06-	DG-170		11V				4
1.9 D	132	Z 19 DTR		12/07-	DG-608		4.4V				4
2.0 T	129/ 154	B207L; B207R; LK9; Z 20 NER; Z 20 NET		04/06-09/10	PK20PR-L11	3142	1.1	-	IK20TT	IK20TT	4
2.0 T AWD	154	B207R; LK9		04/06-09/10	PK20PR-L11	3142	1.1	-	IK20TT	IK20TT	4
2.0 T Flexpower	147	Z 20 LER		12/07-	KJ16CR-L11	3132	1.1	K16TT	IK16TT	IK16TT	4
2.8 T	188	B284L; Z 28 NET		04/06-08/08	IKH20	5344	1.1	-	IKH20TT	IKH20TT	6
CTS (02-07)											
2.6	133/ 136	Y26S		03/02-01/04	K20PBR-S10	5061	1.0	K20TT	IK20TT	IK20TT	6
2.8	158	LP1		03/05-09/07	IKH20	5344	1.1	-	IKH20TT	IKH20TT	6
3.2	160	LA3		03/02-09/07	K20PBR-S10	5061	1.0	K20TT	IK20TT	IK20TT	6
3.6	189	LY7		03/05-09/07	PT16VR13	5068	1.3	TV16TT	ITV16TT	ITV16TT	6
5.7 V8	294	LS6		03/05-09/07	IT16	5325	1.1	-	IT16TT	IT16TT	8
CTS (08-)											
3.6	229	LLT		01/08-09/10	PT16VR13	5068	1.3	TV16TT	ITV16TT	ITV16TT	6
3.6 AWD	229	LLT		01/08-09/10	PT16VR13	5068	1.3	TV16TT	ITV16TT	ITV16TT	6
DEVILLE (90-93)											
4.9 Touring	149	L26		10/90-09/93	T16EPR-U15	5023	1.5	T16TT	IT16TT	IT16TT	8
DEVILLE (93-99)											
4.6	224	L37		10/93-09/99	PT16EPR-L13	5070	1.3	-	IT16TT	IT16TT	8
4.6 Concours	205	LD8		10/93-09/99	PT16EPR-L13	5070	1.3	-	IT16TT	IT16TT	8
4.9	149	L26		10/93-09/95	T16EPR-U15	5023	1.5	T16TT	IT16TT	IT16TT	8

Spark & Glow Plugs



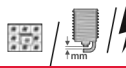



Application Tables







	KW					Standard			Twin Tip				QTY	
CADILLAC <i>continued</i>														
DEVILLE (99-04)														
4.6 DHS	205	LD8		10/99-09/04	PT16EPR-L13	5070	1.3	-	IT16TT	IT16TT			8	
4.6 DTS	224	L37		10/99-09/04	PT16EPR-L13	5070	1.3	-	IT16TT	IT16TT			8	
DTS (05-)														
4.6	205	L37		09/06-	PT16EPR-L13	5070	1.3	-	IT16TT	IT16TT			8	
ELDORADO (87-91)														
4.5	115	LR6		10/87-09/89	T16EPR-U15	5023	1.5	T16TT	IT16TT	IT16TT			8	
4.9	149	L26		10/90-09/91	T16EPR-U15	5023	1.5	T16TT	IT16TT	IT16TT			8	
ELDORADO (91-02)														
4.6	220/ 224	L37; LD8		09/91-09/02	PT16EPR-L13	5070	1.3	-	IT16TT	IT16TT			8	
ESCALADE (98-06)														
5.8	190	LO5		10/98-10/06	PT16EPR-L13	5070	1.3	-	IT16TT	IT16TT			8	
SEVILLE II (K) (79-93)														
4.5	115	LR6		10/87-09/89	T16EPR-U15	5023	1.5	T16TT	IT16TT	IT16TT			8	
4.5 V8	134	LW2		09/87-09/90	T16EPR-U15	5023	1.5	T16TT	IT16TT	IT16TT			8	
4.6	202/ 220	L37; LD8		06/92-09/93	PT16EPR-L13	5070	1.3	-	IT16TT	IT16TT			8	
4.9	149/ 150	L26		10/90-09/93	T16EPR-U15	5023	1.5	T16TT	IT16TT	IT16TT			8	
SEVILLE III (6K) (92-97)														
4.6	202/ 205/ 220/ 224	L37; LD8		06/92-09/97	PT16EPR-L13	5070	1.3	-	IT16TT	IT16TT			8	
SEVILLE IV (97-04)														
4.6	220	L37		10/00-09/04	PT16EPR-L13	5070	1.3	-	IT16TT	IT16TT			8	
4.6 SLS V8	205	LH2		09/97-09/04	PT16EPR-L13	5070	1.3	-	IT16TT	IT16TT			8	
4.6 STS V8	224	LH2		09/97-09/04	PT16EPR-L13	5070	1.3	-	IT16TT	IT16TT			8	
SRX (04-08)														
3.6	190	LY7		07/04-12/08	PT16VR13	5068	1.3	TV16TT	ITV16TT	ITV16TT			6	
3.6 Rear Wheel Drive	190	LY7		01/04-12/08	PT16VR13	5068	1.3	TV16TT	ITV16TT	ITV16TT			6	
4.6	239	LH2		07/04-12/08	PT16EPR-L13	5070	1.3	-	IT16TT	IT16TT			8	
4.6 Rear Wheel Drive	240	LH2		01/04-12/08	PT16EPR-L13	5070	1.3	-	IT16TT	IT16TT			8	
STS (04-)														
3.6	189	LY7		05/05-10/07	PT16VR13	5068	1.3	TV16TT	ITV16TT	ITV16TT			6	
4.6	239	LH2		05/05-10/07	PT16EPR-L13	5070	1.3	-	IT16TT	IT16TT			8	
4.6 AWD	239	LH2		09/04-12/05	PT16EPR-L13	5070	1.3	-	IT16TT	IT16TT			8	
XLR (04-09)														
4.4	331	LC3		06/07-09/09	PT16EPR-L13	5070	1.3	-	IT16TT	IT16TT			8	
4.6	240	LH2		03/04-09/09	PT16EPR-L13	5070	1.3	-	IT16TT	IT16TT			8	
CARBODIES														
FX FAIRWAY (87-)														
2.7 TD	63	TD27		01/87-	DG-001		11V						4	
FX4 (59-89)														
2.2 D	40/50			01/59-08/72	DG-001		11V						4	
2.3 D	44	22E		09/72-08/85	DG-001		11V						4	
2.5 D	50	25V		09/85-12/89	DG-001		11V						4	
FX4R (82-85)														
2.25 D	44	22E		01/82-12/85	DG-101		11V						4	
FX4S (86-89)														
2.5 D	49	25V		01/86-12/89	DG-001		11V						4	
CATERHAM														
21 (94-)														
1.6 i	86			10/94-	K20PR-U	3145	0.8	K20TT	IK20TT	IK20TT			4	
1.6 i Supersport	103			01/96-	Q22PR-U	3010	0.8	-	-	VQ22			4	
SUPER SEVEN (80-)														
1.4 i	97	14 K4F		01/92-	IK22	5310	0.8	-	-	VK22			4	
1.6	86			10/95-09/04	K20PR-U	3145	0.8	K20TT	IK20TT	IK20TT			4	
1.7	99			01/90-12/95	W24ESR-U	4033	0.8	-	-	-			4	
CHERY														
A1 (06-)														
1.3	61	SQR473F		04/07-	Q20R-U	3140	0.8	Q20TT	IQ20TT	IQ20TT			4	
EASTAR CROSS (07-)														
2.0	100	SQE484F		06/07-	K20PR-U	3145	0.8	K20TT	IK20TT	IK20TT			4	
QIYUN (03-10)														
1.3	60	SQR475E		09/06-07/08	K20PR-U	3145	0.8	K20TT	IK20TT	IK20TT			4	
1.6	65	SQR480		08/03-09/07	K20PR-U	3145	0.8	K20TT	IK20TT	IK20TT			4	
QQ3 (03-)														
0.8	38	SQR372		03/04-	K16PR-U	3191	0.8	K16TT	IK16TT	IK16TT			3	

	KW								QTY	
CHERY <i>continued</i>										
QQ6 (06-)										
1.1	39			09/06-	K20PR-U	3145 0.8	K20TT	IK20TT	IK20TT	4
TIGGO 3 (07-)										
2.0	102	SQR484F		05/07-12/10	K20PR-U	3145 0.8	K20TT	IK20TT	IK20TT	4
2.0 All-wheel Drive	102	SQR484F		05/09-12/10	K20PR-U	3145 0.8	K20TT	IK20TT	IK20TT	4
TIGGO (05-08)										
2.0	102	SQR484F		09/06-12/08	K20PR-U	3145 0.8	K20TT	IK20TT	IK20TT	4
2.4	95	4G64S4M		03/05-12/08	K16PR-U11	3130 1.1	K16TT	IK16TT	IK16TT	4
2.4 All-wheel Drive	97	4G64S4M		11/05-12/08	K16PR-U11	3130 1.1	K16TT	IK16TT	IK16TT	4
TIGGO (10-)										
2.0	95/101	SQR484F		01/10-	K20PR-U	3145 0.8	K20TT	IK20TT	IK20TT	4
2.0 All-wheel Drive	102	SQR484F		09/10-	K20PR-U	3145 0.8	K20TT	IK20TT	IK20TT	4
X1 (10-)										
1.3	61	SQR473		01/10-	K20PR-U	3145 0.8	K20TT	IK20TT	IK20TT	4
CHEVROLET										
ALERO (99-04)										
2.4 16V	104	LD9		03/99-09/04	T16EPR-U15	5023 1.5	T16TT	IT16TT	IT16TT	4
ASTRO (84-94)										
4.3	112/119	LB4		10/84-09/94	T16PR-U11	5026 1.1	-	ITF16TT	ITF16TT	6
4.3 AWD	107/112/119	LB4; LF6		10/89-09/94	T16PR-U11	5026 1.1	-	ITF16TT	ITF16TT	6
4.3 Luxury	119	LB4		10/86-09/94	T16PR-U11	5026 1.1	-	ITF16TT	ITF16TT	6
4.3 Luxury AWD	119	LB4; LF6		10/89-09/94	T16PR-U11	5026 1.1	-	ITF16TT	ITF16TT	6
AVALANCHE (00-06)										
5.3	220	LM7		10/00-09/06	T20EPR-U15	5033 1.5	T20TT	IT20TT	IT20TT	8
5.3 AWD	220	LM7		10/00-09/06	T20EPR-U15	5033 1.5	T20TT	IT20TT	IT20TT	8
AVEO (T250, T255) (05-)										
1.2	53	F12S3; LQ5		03/06-	W16EPR-U11	3201 1.1	W16TT	IW16TT	IW16TT	4
1.2	56	B12S1; LY4		01/08-	W20EPR-U11	3049 1.1	W20TT	IW20TT	IW20TT	4
1.2	55/62	B12D1; LMU		01/08-	XU22EPR-U	3179 0.9	XU22TT	-	VXU22	4
1.2 LPG	62	B12D1; LMU		04/08-	XU22EPR-U	3179 0.9	XU22TT	-	VXU22	4
1.4	69	F14D3; L14		03/06-12/07	K20PR-U11	3121 1.1	K20TT	IK20TT	IK20TT	4
1.4	74	A 14 XER; F14D4; LDT		04/08-	KJ20CR-L11	3169 1.1	K20TT	IK20TT	IK20TT	4
1.4	74	F14D4		09/08-06/11	KJ20CR-U11	3451 1.1	K20TT	IK20TT	IK20TT	4
1.5	62	F15S3; LX6		05/05-	W20EPR-U	3047 0.8	W20TT	IW20TT	IW20TT	4
1.6	76/77	A16DMS; F16D3; LXV		05/05-04/09	K20PR-U11	3121 1.1	K20TT	IK20TT	IK20TT	4
AVEO (T300) (11-)										
1.2	51/63	A 12 XEL; A 12 XER		03/11-	KJ20CR-L11	3169 1.1	K20TT	IK20TT	IK20TT	4
1.2 LPG	63	A 12 XER		11/12-	VK20T	5501 0.8	-	IK20TT	IK20TT	4
1.3 D	55/70	LDV; LSF		07/11-	DG-621	4.4V	-	-	-	4
1.4	74	A 14 XER		03/11-	KJ20CR-L11	3169 1.1	K20TT	IK20TT	IK20TT	4
1.6	85	F16D4		03/11-	KJ16CR-L11	3132 1.1	K16TT	IK16TT	IK16TT	4
BLAZER (S10) (82-94)										
2.8	83	LR2		09/82-09/85	T16PR-U11	5026 1.1	-	ITF16TT	ITF16TT	6
2.8 AWD	93	LR2		09/82-12/89	T16PR-U11	5026 1.1	-	ITF16TT	ITF16TT	6
4.3	115/119	LB4		04/88-09/94	T16PR-U11	5026 1.1	-	ITF16TT	ITF16TT	6
4.3 AWD	119	LB4		10/86-09/94	T16PR-U11	5026 1.1	-	ITF16TT	ITF16TT	6
BLAZER (S10) (94-05)										
4.3	142	L35		10/94-05/05	T16EPR-U15	5023 1.5	T16TT	IT16TT	IT16TT	6
4.3 4WD	142	L35		10/97-09/04	T16EPR-U15	5023 1.5	T16TT	IT16TT	IT16TT	6
4.3 AWD	119	LB4		10/94-09/95	T16PR-U11	5026 1.1	-	ITF16TT	ITF16TT	6
4.3 V6 AWD	142	L35		01/94-09/05	T16EPR-U15	5023 1.5	T16TT	IT16TT	IT16TT	6
C1500 (91-00)										
4.3	119	LB4		10/91-09/96	T16PR-U11	5026 1.1	-	ITF16TT	ITF16TT	6
4.3 AWD	119	LB4		10/91-09/96	T16PR-U11	5026 1.1	-	ITF16TT	ITF16TT	6
6.5 TDIC	135	L56		10/96-12/00	DG-001	11V	-	-	-	8
C2500 (91-96)										
4.3	119	LB4		10/91-09/96	T16PR-U11	5026 1.1	-	ITF16TT	ITF16TT	6
4.3 AWD	119	LB4		10/91-09/96	T16PR-U11	5026 1.1	-	ITF16TT	ITF16TT	6
C2500 (96-)										
5.7 RC	190	L31		10/96-04/00	T20PR-U	5035 0.9	-	ITF20TT	ITF20TT	8
5.7 RC AWD	186	L31		10/96-04/00	T20PR-U	5035 0.9	-	ITF20TT	ITF20TT	8
6.5 TDIC	135	L56		10/96-	DG-175	10.5V	-	-	-	8
6.5 TDIC AWD	135	L56		10/96-	DG-175	10.5V	-	-	-	8

Spark & Glow Plugs



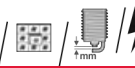





Application Tables

	KW					Standard			Twin Tip			QTY	
CHEVROLET <i>continued</i>													
C3500 (93-96)													
6.5 TDIC	135	L56		10/93-09/96	DG-001		11V						8
6.5 TDIC AWD	135	L56		10/93-09/96	DG-001		11V						8
CAMARO (70-81)													
5.0	110	LG4		01/70-12/81	T16PR-U11	5026	1.1	-	ITF16TT	ITF16TT			8
CAMARO (81-92)													
5.0	112	LG4		12/81-12/92	T16PR-U11	5026	1.1	-	ITF16TT	ITF16TT			8
CAMARO (92-02)													
3.4	119	L32		10/92-09/95	T20PR-U15	5037	1.5	-	ITF20TT	ITF20TT			6
3.4 V6	119	L32		12/92-07/98	T20PR-U15	5037	1.5	-	ITF20TT	ITF20TT			6
CAPRICE (70-83)													
5.0	112	LG4		01/70-12/83	T16PR-U11	5026	1.1	-	ITF16TT	ITF16TT			8
CAPRICE (81-90)													
4.3	119	LB4		10/84-09/89	T16PR-U11	5026	1.1	-	ITF16TT	ITF16TT			6
CAPTIVA (06-)													
2.0 D	93/ 110	Z 20 S		10/06-	DG-604		4.4V						4
2.0 D 4WD	93/ 110	Z 20 S		10/06-	DG-604		4.4V						4
2.4	123	LE5/2.44		03/11-	ITL16	5349	1.1	-	ITL16TT	ITL16TT			4
2.4	100/ 103	Z 24 SED		06/06-02/11	K20TXR	5063	1.0	K20TT	IK20TT	IK20TT			4
2.4 4WD	123	LE5/2.44		03/11-	ITL16	5349	1.1	-	ITL16TT	ITL16TT			4
2.4 4WD	100/ 103	LD9//2.4F(136-Z24XE); Z 24 SED		06/06-02/11	K20TXR	5063	1.0	K20TT	IK20TT	IK20TT			4
2.4 LPG	100	LD9//2.4F(GPL)	LPG / GPL	01/07-09/09	VK20T	5501	0.8	-	IK20TT	IK20TT			4
2.4 LPG 4WD	100	LD9//2.4F(GPL)	LPG / GPL	01/07-09/09	VK20T	5501	0.8	-	IK20TT	IK20TT			4
3.0 4WD	190	LF1/3.0C		02/11-	ITV20	5339	1.1	-	ITV20TT	ITV20TT			6
3.2 4WD	169	LU1/3.2G(Z32SE)		06/06-09/09	PK16PR-L11	3275	1.1	-	IK16TT	IK16TT			6
3.2 4WD	169	LU1/3.2G(Z32SE)		09/09-02/11	PT16VR13	5068	1.3	TV16TT	ITV16TT	ITV16TT			6
CAVALIER (91-03)													
2.4 LT	112	LD9		10/95-09/03	T16EPR-U15	5023	1.5	T16TT	IT16TT	IT16TT			4
C-K SERIE (94-00)													
5.7	190	L31		10/96-04/00	T20PR-U	5035	0.9	-	ITF20TT	ITF20TT			8
5.7 AWD	190	L31		10/96-04/00	T20PR-U	5035	0.9	-	ITF20TT	ITF20TT			8
COBALT (11-)													
1.5	79	L2C		01/14-	XU22EPR-U	3179	0.9	XU22TT	-	VXU22			4
CRUZE (00-08)													
1.3	61	M13A		07/00-09/08	K20PR-U11	3121	1.1	K20TT	IK20TT	IK20TT			4
1.3 AWD	61	M13A		07/00-09/08	K20PR-U11	3121	1.1	K20TT	IK20TT	IK20TT			4
1.5	73	M15A		08/03-09/08	VK20	5604	1.1	-	IK20TT	IK20TT			4
1.5 AWD	73	M15A		08/03-09/08	VK20	5604	1.1	-	IK20TT	IK20TT			4
CRUZE (09-)													
1.4	74	A 14 XER; LDD		07/13-	KJ20CR-L11	3169	1.1	K20TT	IK20TT	IK20TT			4
1.6	80	LXT		01/12-	K20PR-U11	3121	1.1	K20TT	IK20TT	IK20TT			4
1.6	82/ 83/ 86/ 89/ 91	F16D4; LDE		05/09-	KJ20CR-U11	3451	1.1	K20TT	IK20TT	IK20TT			4
1.6	80	F16D3; LXT; LXV		05/09-	XU24EPR-U	3312	0.9	-	-	VXU24			4
1.8	103	LUW		11/09-	KJ16CR-L11	3132	1.1	K16TT	IK16TT	IK16TT			4
1.8	102/ 104	2H0; F18D4		05/09-	KJ20CR-U11	3451	1.1	K20TT	IK20TT	IK20TT			4
1.8 LPG	104	2H0; F18D4		06/11-	VK20	5604	1.1	-	IK20TT	IK20TT			4
2.0 CDI	92/ 110	Z 20 DMH; Z 20 S1		05/09-	DG-604		4.4V						4
EPICA (05-)													
2.0	105	XKL6		06/06-09/09	K20PBR-S10	5061	1.0	K20TT	IK20TT	IK20TT			6
2.0 D	110	Z 20 S		01/07-	DG-604		4.4V						4
2.5	115	LF4		06/06-09/09	PK20PR-L11	3142	1.1	-	IK20TT	IK20TT			6
EVANDA (05-)													
2.0	96	C20SED		03/05-06/07	K20TXR	5063	1.0	K20TT	IK20TT	IK20TT			4
2.0	96	C20SED(GPL)	Flexible fuel	03/05-06/07	VK20T	5501	0.8	-	IK20TT	IK20TT			4
EXPRESS (95-98)													
4.3	142	L35		10/95-09/98	T16EPR-U15	5023	1.5	T16TT	IT16TT	IT16TT			6
HHR (06-11)													
2.2	108	L61		01/06-12/11	ITL16	5349	1.1	-	ITL16TT	ITL16TT			4
2.4	125/ 128	LE5		01/06-12/11	ITL16	5349	1.1	-	ITL16TT	ITL16TT			4
KALOS (05-)													
1.2	53	B12S1; F12S3		03/05-	W16EPR-U	3021	0.8	W16TT	IW16TT	IW16TT			4

	KW								QTY	
CHEVROLET <i>continued</i>										
KALOS (05-) <i>continued</i>										
1.4	61	F14S3		03/05-	W20EPR-U	3047	0.8	W20TT	IW20TT	4
1.4 16V	69	F14D3		03/05-	K20PR-U11	3121	1.1	K20TT	IK20TT	4
LACETTI (05-)										
1.4	70			03/05-	K20PR-U11	3121	1.1	K20TT	IK20TT	4
1.4 16V	70	F14D3		03/05-	K20PR-U11	3121	1.1	K20TT	IK20TT	4
1.6	80	F16D3		03/05-04/09	K20PR-U11	3121	1.1	K20TT	IK20TT	4
1.8	89	H18D		08/05-01/07	K20PBR-S10	5061	1.0	K20TT	IK20TT	4
1.8	89/90	T18SED		03/05-	K20TXR	5063	1.0	K20TT	IK20TT	4
2.0 D	89	Z 20 DM		01/07-	DG-604		4.4V			4
LANOS (05-)										
1.4	55			11/05-	W20EPR-U	3047	0.8	W20TT	IW20TT	4
1.5	63	A15SMS(86-LX6)		11/05-	W20EPR-U	3047	0.8	W20TT	IW20TT	4
1.6 16V	78	A16DMS		11/05-	K20PR-U11	3121	1.1	K20TT	IK20TT	4
MALIBU (80-83)										
5.0	110	LG4		01/80-12/83	T16PR-U11	5026	1.1	-	ITF16TT	8
MALIBU (96-05)										
2.4	112	LD9		08/96-09/02	T16EPR-U15	5023	1.5	T16TT	IT16TT	4
MATIZ (05-)										
0.8	38	F8CV		03/05-	Q16R-U11	3006	1.1	Q16TT	IQ16TT	3
0.8 LPG	38	F8CV	LPG / GPL	03/05-	VQ16	5601	1.1	-	IQ16TT	3
1.0	47/48/49	B10S; B10S1; LA2		03/05-	Q16R-U11	3006	1.1	Q16TT	IQ16TT	4
1.0 LPG	49	B10S1	LPG / GPL	03/05-	VQ16	5601	1.1	-	IQ16TT	4
NIVA (2121) (02-)										
1.7 4x4	59/61			09/02-	W20EPR-U	3047	0.8	W20TT	IW20TT	4
1.8 4x4	92	Z 18 XE		01/07-12/09	KJ16CR-L11	3132	1.1	K16TT	IK16TT	4
NUBIRA (05-)										
1.4	69	F14D3		01/05-	K20PR-U11	3121	1.1	K20TT	IK20TT	4
1.6	80	F16D3		03/05-	K20PR-U11	3121	1.1	K20TT	IK20TT	4
1.8	89/90	F18D3; T18SED		03/05-	K20TXR	5063	1.0	K20TT	IK20TT	4
2.0 D	89	Z 20 DM; Z 20 S		01/05-	DG-604		4.4V			4
OPTRA (03-08)										
1.6	78	LXT		08/03-12/08	K20PR-U11	3121	1.1	K20TT	IK20TT	4
1.8	90	T18SED		08/03-12/08	K20TXR	5063	1.0	K20TT	IK20TT	4
ORLANDO (11-)										
1.8	104	2H0; F18D4		02/11-	KJ20CR-U11	3451	1.1	K20TT	IK20TT	4
1.8 LPG	104	2H0		06/11-	VK20	5604	1.1	-	IK20TT	4
REZZO (05-)										
1.6	77/79	A16DMS		03/05-06/08	K20PR-U11	3121	1.1	K20TT	IK20TT	4
2.0	89/90	X20SED(121)		03/05-06/08	K20TXR	5063	1.0	K20TT	IK20TT	4
2.0	89/90	X20SED-G(121)	Flexible fuel	03/05-06/08	VK20T	5501	0.8	-	IK20TT	4
S10 Pick Up (83-91)										
4.3 AWD	119	LB4		10/87-09/91	T16PR-U11	5026	1.1	-	ITF16TT	6
S10 Pick Up (94-05)										
4.3	142	L35		10/94-12/04	T16EPR-U15	5023	1.5	T16TT	IT16TT	6
4.3 AWD	142	L35		10/94-08/02	T16EPR-U15	5023	1.5	T16TT	IT16TT	6
4.3 AWD	119	LB4		10/94-09/95	T16PR-U11	5026	1.1	-	ITF16TT	6
SILVERADO (99-)										
5.3 AWD	201/212	LM7		10/99-	T20EPR-U15	5033	1.5	T20TT	IT20TT	8
SPARK (00-04)										
0.8	38	F8CV		09/00-12/04	W16EPR-U11	3201	1.1	W16TT	IW16TT	3
SPARK (05-)										
0.8	37	F8CV		05/05-	W16EPR-U11	3201	1.1	W16TT	IW16TT	3
1.0 SX	46/49	B10S; B10S1; LA2		05/05-	W16EPR-U11	3201	1.1	W16TT	IW16TT	4
SPARK (10-)										
1.0	50	B10D1		03/10-	XU22EPR-U	3179	0.9	XU22TT	-	4
1.0 LPG	48/50	B10D1		03/10-	VXU22	5608	0.9	-	-	4
1.2	60	B12D1; LMU		03/10-	XU22EPR-U	3179	0.9	XU22TT	-	4
1.2 LPG	60	B12D1; LMU		03/10-	XU22EPR-U	3179	0.9	XU22TT	-	4
SPIN (12-)										
1.5	79			01/13-	XU22EPR-U	3179	0.9	XU22TT	-	4
SUBURBAN (91-00)										
5.7	190	L31		10/96-04/00	T20PR-U	5035	0.9	-	ITF20TT	8
5.7 AWD	190	L31		10/96-04/00	T20PR-U	5035	0.9	-	ITF20TT	8
TAHOE (94-96)										
6.5 TDIC	135	L56		10/94-09/96	DG-175		10.5V			8







Spark & Glow Plugs

Application Tables







	KW								QTY	
CHEVROLET <i>continued</i>										
TAHOE (94-96) <i>continued</i>										
6.5 TDiC AWD	135	L56		10/94-09/96	DG-175	10.5V			8	
TAHOE (99-06)										
4.8	206	LR4		05/00-12/06	T20EPR-U15	5033 1.5	T20TT	IT20TT	IT20TT	8
4.8 V8	206	LR4		12/99-12/06	T20EPR-U15	5033 1.5	T20TT	IT20TT	IT20TT	8
5.3	201/213/220	L59; LM7		05/00-12/06	T20EPR-U15	5033 1.5	T20TT	IT20TT	IT20TT	8
5.3 AWD	213	L59		10/02-12/06	T20EPR-U15	5033 1.5	T20TT	IT20TT	IT20TT	8
5.3 V8 AWD	201	LM7		12/99-12/06	T20EPR-U15	5033 1.5	T20TT	IT20TT	IT20TT	8
TRAILBLAZER (01-08)										
4.2 AWD	201	LL8		09/01-09/08	PT16VR13	5068 1.3	TV16TT	ITV16TT	ITV16TT	6
TRANS SPORT (96-05)										
3.4	137	LA1		08/96-09/05	T20EPR-U15	5033 1.5	T20TT	IT20TT	IT20TT	6
3.4 V6	138	LA1		10/00-09/05	T20EPR-U15	5033 1.5	T20TT	IT20TT	IT20TT	6
3.4 V6 AWD	138	LA1		10/01-09/05	T20EPR-U15	5033 1.5	T20TT	IT20TT	IT20TT	6
TRAX (12-)										
1.6	85	F16D4; LDE		12/12-	KJ20CR-U11	3451 1.1	K20TT	IK20TT	IK20TT	4
1.6 AWD	85	F16D4; LDE		12/12-	KJ20CR-U11	3451 1.1	K20TT	IK20TT	IK20TT	4
VIVA (03-08)										
1.8	90/92	Z 18 XE		09/03-03/08	KJ16CR-L11	3132 1.1	K16TT	IK16TT	IK16TT	4
CHRYSLER										
300 C (04-12)										
2.7	142	EER-E4(193)		09/07-11/12	ITL16	5349 1.1	-	ITL16TT	ITL16TT	6
2.7	130/142	EER-E4(193); EES		09/04-11/12	ITL20	5350 1.1	-	-	-	6
3.0 CRD	160	EXL		09/05-11/12	DG-194	4.4V				6
3.5	183/186	3.5CSP; EEG		09/04-11/12	IK16L	5357 1.1	-	IK16TT	IK16TT	6
3.5 AWD	183	3.5CSP		09/04-12/10	IK16L	5357 1.1	-	IK16TT	IK16TT	6
5.7	250	EZB; EZD; EZH		09/04-12/08	ITL16	5349 1.1	-	ITL16TT	ITL16TT	8
5.7 AWD	250	EZB; EZH		04/05-12/08	ITL16	5349 1.1	-	ITL16TT	ITL16TT	8
6.1 SRT8	317	ESF		06/05-11/12	ITL20	5350 1.1	-	-	-	16
300 C (11-)										
3.6	215	ERB		07/11-	ITV20	5339 1.1	-	ITV20TT	ITV20TT	6
300 M (98-04)										
2.7 V6 24V	149/150	EER(203); EES		11/98-04/03	ITL20	5350 1.1	-	-	-	6
3.5 V6 24V	185/187	EGC; EGG		07/98-04/03	PKJ16CR-L13	3357 1.3	-	IK16TT	IK16TT	6
CIRRUS (94-00)										
2.0 LX	96/98	ECB		05/94-09/00	K20PR-U	3145 0.8	K20TT	IK20TT	IK20TT	4
2.4 LX	103	EDZ		05/94-09/00	K16R-U11	3120 1.1	K16TT	IK16TT	IK16TT	4
CIRRUS (00-07)										
2.0	104	ECC		09/00-04/07	ITL16	5349 1.1	-	ITL16TT	ITL16TT	4
CROSSFIRE (03-07)										
3.2	160	EGX		07/03-12/07	SK20PR-L9	3307 0.9	-	IK20TT	IK20TT	6
SRT-6	246	EGZ		09/04-12/07	SK20PR-L9	3307 0.9	-	IK20TT	IK20TT	6
DELTA (11-)										
1.4	88	198 A4.000		08/11-	IXU27	5337 0.9	-	-	-	4
1.4 16V	103	198 A7.000		08/11-	IXU27	5337 0.9	-	-	-	4
1.6 D Multijet	88	198 A2.000		08/11-	DG-608	4.4V				4
2.0 D Multijet	121	198 A5.000		08/11-	DG-608	4.4V				4
GRAND VOYAGER (07-)										
3.3	125	EGA		01/08-02/08	ITL16	5349 1.1	-	ITL16TT	ITL16TT	6
3.6	208	ERB		02/11-	ITV20	5339 1.1	-	ITV20TT	ITV20TT	6
3.8	142	EGL(193)		10/07-	ITL16	5349 1.1	-	ITL16TT	ITL16TT	6
LE BARON (86-96)										
2.2 i Turbo	109/130	CHRY02		09/86-12/90	W16EPR-U	3021 0.8	W16TT	IW16TT	IW16TT	4
2.5 i	75	EDM		09/86-12/94	W16EPR-U	3021 0.8	W16TT	IW16TT	IW16TT	4
2.5 i Turbo	112	CHRY03		01/89-12/94	W16EPR-U	3021 0.8	W16TT	IW16TT	IW16TT	4
3.0 i V6	105	6G72		01/90-12/96	W16EPR-U11	3201 1.1	W16TT	IW16TT	IW16TT	6
NEON (94-99)										
1.8 16V	85	EBD		09/97-08/99	K20PR-U	3145 0.8	K20TT	IK20TT	IK20TT	4
2.0 16V	98/107/109	ECB; ECC; ECM		05/94-08/99	K20PR-U	3145 0.8	K20TT	IK20TT	IK20TT	4
NEON (99-)										
1.6	85	EJD		11/01-09/05	K20PR-U	3145 0.8	K20TT	IK20TT	IK20TT	4
2.0 16V	97/98	ECB		08/99-12/06	K20PR-U	3145 0.8	K20TT	IK20TT	IK20TT	4











Spark & Glow Plugs







Application Tables







	KW					Standard		Twin Tip		QTY	
CHRYSLER <i>continued</i>											
NEON (99-) <i>continued</i>											
2.0 16V R/T	110	ECH		10/01-09/05	K20PR-U	3145	0.8	K20TT	IK20TT	IK20TT	4
NEW YORKER (93-98)											
3.5 i 24V	155	EGE		04/93-09/98	QJ16HR-U9	5018	0.9	-	-	-	6
PT CRUISER (00-10)											
1.6	85	EJD		11/01-09/04	K20R-U	3122	0.8	K20TT	IK20TT	IK20TT	4
2.0	100/ 104	ECC		06/00-12/10	ITL16	5349	1.1	-	ITL16TT	ITL16TT	4
2.2 CRD	89/ 110	EDJ		03/02-12/10	DG-117		11.5V				4
2.4	105/ 110	EDZ(143); EDZ		06/00-12/10	ITL16	5349	1.1	-	ITL16TT	ITL16TT	4
2.4 GT	164	EDV-223		03/04-03/08	ITL16	5349	1.1	-	ITL16TT	ITL16TT	4
GT 2.4	164	EDV-223		08/03-11/07	ITL16	5349	1.1	-	ITL16TT	ITL16TT	4
SARATOGA (89-95)											
3.0	105	6G72		09/89-12/95	W16EXR-U13	3213	1.3	W16TT	IW16TT	IW16TT	6
SEBRING (01-07)											
2.0	104	ECC		04/01-06/07	ITL16	5349	1.1	-	ITL16TT	ITL16TT	4
2.4	105/ 112	EDZ		04/01-06/07	ITL16	5349	1.1	-	ITL16TT	ITL16TT	4
2.7 V6 24V	149	EER; EES		04/01-06/07	ITL20	5350	1.1	-	-	-	6
SEBRING (07-10)											
2.0 CRD	103	ECD		03/09-12/10	DG-190		4.4V				4
2.0 VVT	115	ECN		07/07-12/10	KJ16CR-U11	3311	1.1	K16TT	IK16TT	IK16TT	4
2.4 VVT	125	ED3		07/07-12/10	KJ16CR-U11	3311	1.1	K16TT	IK16TT	IK16TT	4
2.7	137	EER(186)		07/07-12/10	ITL20	5350	1.1	-	-	-	6
STRATUS (95-01)											
2.0 16V	98	ECB		12/95-04/01	K20PR-U	3145	0.8	K20TT	IK20TT	IK20TT	4
2.0 LE	96	420X; ECB		12/95-04/01	K20PR-U	3145	0.8	K20TT	IK20TT	IK20TT	4
2.4 16 V	103	EDZ		12/95-04/01	K16R-U11	3120	1.1	K16TT	IK16TT	IK16TT	4
2.4 16V	112	EDZ		12/95-04/01	K16R-U11	3120	1.1	K16TT	IK16TT	IK16TT	4
2.5 LX	120	625H		04/96-04/01	PK16PR-L11	3275	1.1	-	IK16TT	IK16TT	6
2.5 LX V6	120	EEB		12/95-04/01	PK16PR-L11	3275	1.1	-	IK16TT	IK16TT	6
2.5 V6	125	H00		12/95-04/01	PK16PR-L11	3275	1.1	-	IK16TT	IK16TT	6
VISION (93-97)											
3.5 TSi	155	EGE		09/93-12/97	QJ16HR-U9	5018	0.9	-	-	-	6
VOYAGER (87-90)											
3.3	112	EGA		10/89-09/90	W16EXR-U13	3213	1.3	W16TT	IW16TT	IW16TT	6
VOYAGER (90-95)											
2.5 i	72/74	EDM		08/90-09/95	W16EPR-U	3021	0.8	W16TT	IW16TT	IW16TT	4
2.5 TD	87	09B; M00		01/92-09/95	DG-001		11V				4
3.0 i	108	EFA		01/91-02/91	W16EPR-U11	3201	1.1	W16TT	IW16TT	IW16TT	6
3.3 i	110/ 120	EGA		08/90-09/95	W16EXR-U13	3213	1.3	W16TT	IW16TT	IW16TT	6
3.3 i AWD	110/ 120	EGA(U3); EGA		08/90-09/95	W16EXR-U13	3213	1.3	W16TT	IW16TT	IW16TT	6
VOYAGER (95-01)											
2.0 i	98	C00		01/95-03/01	K20PR-U	3145	0.8	K20TT	IK20TT	IK20TT	4
2.4 AWD	111	EDZ		02/97-03/01	K16R-U11	3120	1.1	K16TT	IK16TT	IK16TT	4
2.4 i	111	B00		01/95-03/01	K16R-U11	3120	1.1	K16TT	IK16TT	IK16TT	4
2.5 TD	85	425 CLIRS/X; ENC		01/95-04/95	DG-001		11V				4
2.5 TD	85	425 CLIRS/X; ENC		05/95-03/01	DG-109		11V				4
2.5 TDIC AWD	85	ENC		10/95-03/01	DG-109		11V				4
3.0	112	EFA		01/95-03/01	W16EPR-U	3021	0.8	W16TT	IW16TT	IW16TT	6
3.3 i	116	R00		10/96-03/01	P16R13	3239	1.3	W20TT	IW20TT	IW20TT	6
3.3 i	116	R00		01/95-09/96	W16EXR-U13	3213	1.3	W16TT	IW16TT	IW16TT	6
3.8 i AWD	122/ 131	EGH; L00		10/96-03/01	P16R13	3239	1.3	W20TT	IW20TT	IW20TT	6
3.8 i AWD	122/ 131	EGH; L00		01/95-09/96	W16EXR-U13	3213	1.3	W16TT	IW16TT	IW16TT	6
VOYAGER (00-08)											
2.4	108	EDZ		02/00-12/08	ITL16	5349	1.1	-	ITL16TT	ITL16TT	4
2.5 CRD	88/ 105	EDK; ENC		02/00-12/08	DG-176		11.5V				4
2.8 CRD	110	ENR		06/04-12/08	DG-176		11.5V				4
3.3	128	EGA		02/00-12/08	ITL16	5349	1.1	-	ITL16TT	ITL16TT	6
3.3 AWD	128	EGA		02/00-12/08	ITL16	5349	1.1	-	ITL16TT	ITL16TT	6
3.8	160	EGH-218		03/01-04/04	P16R13	3239	1.3	W20TT	IW20TT	IW20TT	6
3.8 AWD	160	EGH-218		03/01-04/04	P16R13	3239	1.3	W20TT	IW20TT	IW20TT	6
YPSILON (846) (11-)											
1.2	51	169 A4.000		05/11-	XU22EPR-U	3179	0.9	XU22TT	-	VXU22	4









KW	KW	KW	NOTE	21	Standard			Twin Tip			QTY
					Standard	Standard	Standard	Twin Tip	Twin Tip	Twin Tip	
CITROËN											
2 CV (63-90)											
4	17	A79/1 (AYA2)		01/70-12/75	W20FPR-U	3070	0.7	WF20TT	-	-	2
4	12	A 53		03/63-02/70	W20FSR-U	6053	0.7	WF20TT	-	-	2
6	18/ 20/ 21	A06/635; A06/664		02/70-10/85	W20FSR-U	6053	0.7	WF20TT	-	-	2
ACADIANE (78-88)											
6	22/23	M28 (AM2)		08/78-10/88	W20FSR-U	6053	0.7	WF20TT	-	-	2
AMI (63-77)											
8 (AM3)	24	M28 (AM2)		07/69-12/77	W20FSR-U	6053	0.7	WF20TT	-	-	2
AX (86-98)											
1.4 GTi	66/ 69/ 74	KFY (TU3FJ2); KFZ (TU3FJ2)		06/91-10/94	K22PBR-S	5062	0.85	-	-	VK22	4
10	33/37	CDY (TU9M); CDZ (TU9M)		07/86-12/98	K20TXR	5063	1.0	K20TT	IK20TT	IK20TT	4
10	32	C1A		09/86-06/92	Q20P-U	3125	0.8	Q20TT	IQ20TT	IQ20TT	4
10 E	30	C3A		12/86-12/88	Q20P-U	3125	0.8	Q20TT	IQ20TT	IQ20TT	4
11	40/44	H1A; H1B; HDZ (TU1M)		09/86-12/97	K20TXR	5063	1.0	K20TT	IK20TT	IK20TT	4
11 4x4	40	H1A		06/91-07/92	K20TXR	5063	1.0	K20TT	IK20TT	IK20TT	4
11 CAT	40	HAZ (TU1CP)		09/88-12/89	K20PR-U	3145	0.8	K20TT	IK20TT	IK20TT	4
14	51/55	KDX (TU3M/Z); KDY (TU3FM); KDY (TU3M); KDZ (TU3M/Z); TU3A(K1G) - K		04/87-04/97	K20PR-U	3145	0.8	K20TT	IK20TT	IK20TT	4
14	44	KAY (TU3CP)		12/86-12/88	Q20PR-U	3007	0.8	Q20TT	IQ20TT	IQ20TT	4
14	61/62	K2A; K2B		01/88-12/92	Q22PR-U	3010	0.8	-	-	VQ22	4
14	49	K1F	Ch: Org Nr.4193>	06/88-12/89	Q20P-U	3125	0.8	Q20TT	IQ20TT	IQ20TT	4
14 4x4	55	KDX (TU3M/Z); KDY (TU3FM); KDY (TU3M); KDZ (TU3M/Z)		08/91-12/96	Q16PR-U	3137	0.8	Q16TT	IQ16TT	IQ16TT	4
14 D	37/38	K9A (TUD3); K9Y (TUD3Y)		09/88-12/97	DG-004		11.5V				4
14 GT	59	KDZ (TU3M/Z)		01/89-12/91	Q20PR-U	3007	0.8	Q20TT	IQ20TT	IQ20TT	4
15 D	40/43	VJY (TUD5); VJZ (TUD5)		08/94-12/97	DG-003		11V				4
AXEL (81-91)											
11	42	G11/631		01/84-06/89	T22EP-U	5040	0.8	-	-	-	4
BERLINGO (B9) (08-)											
1.4	55	KFW (TU3JP)		03/09-	K20PR-U	3145	0.8	K20TT	IK20TT	IK20TT	4
1.6	80	NFU (TU5JP4)		04/08-	K16HPR-U11	6076	1.1	KH16TT	IKH16TT	IKH16TT	4
1.6	66	NFR (TU5JP4B)	OEM Optional	04/08-	K16HPR-U11	6076	1.1	KH16TT	IKH16TT	IKH16TT	4
1.6 HDi 110	80	9HZ (DV6TED4)		04/08-	DG-180		11V				4
1.6 HDi 110	82	9HL (DV6C); 9HR (DV6C)		07/10-	DG-603		5V				4
1.6 HDi 115	84	9HL (DV6C); 9HR (DV6C)		07/10-	DG-603		5V				4
1.6 HDi 75	55	9HT (DV6BTED4); 9HT (DV6BUTED4)		04/08-	DG-180		11V				4
1.6 HDi 90	66/68	9HP (DV6DTE4); 9HS (DV6TED4BU); 9HX (DV6ATED4)		04/08-	DG-180		11V				4
1.6 VTi 120	88	5FS (EP6C)		11/09-	VXUH22	5611	0.9	-	-	VXUH22	4
1.6 VTi 95	72	5FK (EP6CB)		07/10-	VXUH22	5611	0.9	-	-	VXUH22	4
BERLINGO (MF) (96-)											
1.1 i (MAHDZ, MBHDZ, MBHFX)	44	HDZ (TU1M)		07/96-	K20TXR	5063	1.0	K20TT	IK20TT	IK20TT	4
1.1 i (MFHDZ, MFHFX)	44	HDZ (TU1M)		07/96-	K20TXR	5063	1.0	K20TT	IK20TT	IK20TT	4
1.4	48/53	KFW (TU3JP)		11/02-	K20PR-U	3145	0.8	K20TT	IK20TT	IK20TT	4
1.4 bivalent	48	KFW (TU3JP)		11/02-	K20PR-U	3145	0.8	K20TT	IK20TT	IK20TT	4
1.4 GNC	48	KFW (TU3JP)		11/02-	K20PR-U	3145	0.8	K20TT	IK20TT	IK20TT	4
1.4 Hybrid	54	KFW (TU3JP)		05/05-	K20PR-U	3145	0.8	K20TT	IK20TT	IK20TT	4
1.4 i (MBKFX, MBKFW)	55	KFW (TU3JP); KFX (TU3JP)		07/96-	K20PR-U	3145	0.8	K20TT	IK20TT	IK20TT	4
1.4 i (MFKFX, MFKFW)	55	KFW (TU3JP); KFX (TU3JP)		07/96-	K20PR-U	3145	0.8	K20TT	IK20TT	IK20TT	4
1.4 i bivalent (MBKFW)	55	KFW (TU3JP)		04/03-	K20PR-U	3145	0.8	K20TT	IK20TT	IK20TT	4
1.4 i bivalent (MFKFW)	55	KFW (TU3JP)		04/03-	K20PR-U	3145	0.8	K20TT	IK20TT	IK20TT	4
1.6 16V (MBNFU)	80	NFU (TU5JP4)		10/00-	K16HPR-U11	6076	1.1	KH16TT	IKH16TT	IKH16TT	4
1.6 16V (MNFU)	80/81	NFU (TU5JP4)		10/00-	K16HPR-U11	6076	1.1	KH16TT	IKH16TT	IKH16TT	4

	KW					Standard		Twin Tip			QTY
CITROËN <i>continued</i>											
BERLINGO (MF) (96-) <i>continued</i>											
1.6 HDI 110	80	9HZ (DV6TED4)	Ch: >ORP 10783	08/05-05/06	DG-113		11V				4
1.6 HDI 110	80	9HZ (DV6TED4)	Ch: ORP 10784>	05/06-	DG-180		11V				4
1.6 HDI 75 (MB9HW)	55	DV6ETED (9HW)		07/05-05/08	DG-180		11V				4
1.6 HDI 75 (MB9HW)	55	DV6BTED4 (9HT)	Ch: >ORP 10783	07/05-05/06	DG-113		11V				4
1.6 HDI 75 (MB9HW)	55	DV6BTED4 (9HT)	Ch: ORP 10784>	05/06-05/08	DG-180		11V				4
1.6 HDI 75 (MF9HW)	55	DV6ETED (9HW)		07/05-05/08	DG-180		11V				4
1.6 HDI 75 (MF9HW)	55	DV6BTED4 (9HT)	Ch: >ORP 10783	07/05-05/06	DG-113		11V				4
1.6 HDI 75 (MF9HW)	55	DV6BTED4 (9HT)	Ch: ORP 10784>	05/06-05/08	DG-180		11V				4
1.6 HDI 90 (MB9HX, MC9HX)	66	DV6ATED4 (9HX)	Ch: >ORP 10783	07/05-05/06	DG-113		11V				4
1.6 HDI 90 (MB9HX, MC9HX)	66	DV6ATED4 (9HX)	Ch: ORP 10784>	05/06-05/08	DG-180		11V				4
1.6 HDI 90 (MF9HX)	66	DV6ATED4 (9HX)	Ch: >ORP 10783	07/05-05/06	DG-113		11V				4
1.6 HDI 90 (MF9HX)	66	DV6ATED4 (9HX)	Ch: ORP 10784>	05/06-05/08	DG-180		11V				4
1.8 D (MBA9A, MCA9A)	43	A9A (XUD7)		07/96-	DG-001		11V				4
1.8 D (MFA9A)	43	A9A (XUD7)		07/98-	DG-001		11V				4
1.8 i (MFLFX)	66	LFX (XU7JB)		05/97-	K20TXR	5063	1.0	K20TT	IK20TT	IK20TT	4
1.8 i 4WD (MFLFX)	66	LFX (XU7JB)		04/97-	K20TXR	5063	1.0	K20TT	IK20TT	IK20TT	4
1.9 D (MBDJY)	51	DJY (XUD9A)		07/96-	DG-001		11V				4
1.9 D (MFDJY)	50/51	D9B (XUD9A/L); DJY (XUD9A)		07/96-	DG-001		11V				4
1.9 D (MFWJZ)	51	WJY (DW8B); WJZ (DW8)		07/98-10/05	DG-003		11V				4
1.9 D 4WD (MFWJZ)	51	WJY (DW8B); WJZ (DW8)		07/98-	DG-003		11V				4
1.9 D 70 (MBWJZ, MCWJZ)	51	WJY (DW8B); WJZ (DW8)		04/99-	DG-003		11V				4
1.9 D 70 4WD (MBWJZ, MCWJZ)	51	WJY (DW8B); WJZ (DW8)		07/98-	DG-003		11V				4
2.0 HDi 4x4 (MFRHY)	66	RHY (DW10TD)		11/02-10/05	DG-116		11V				4
2.0 HDi 90 (MBRHY, MCRHY)	66	RHY (DW10TD)		12/99-	DG-116		11V				4
2.0 HDi 90 (MFRHY)	66	RHY (DW10TD)		12/99-	DG-116		11V				4
2.0 HDi 90 4WD (MBRHY, MCRHY)	66	RHY (DW10TD)		11/00-	DG-116		11V				4
BX (82-94)											
1.4	44	XY7CP(KAZ) - Z		01/87-04/88	K20PR-U	3145	0.8	K20TT	IK20TT	IK20TT	4
1.4	52	150C	Ch: >Org Nr.4192	01/87-01/92	T20EP-U	5031	0.8	T20TT	IT20TT	IT20TT	4
1.8 D	44	161 (XUD7)		10/85-09/93	DG-001		11V				4
1.9 All-wheel Drive	92			02/92-06/94	Q22P-U	3255	0.8	-	-	VQ22	4
1.9 Tzi	92	D6A (XU9J2)		02/92-12/94	Q22P-U	3255	0.8	-	-	VQ22	4
11	40	HDZ (TU1M)		10/88-06/92	K20TXR	5063	1.0	K20TT	IK20TT	IK20TT	4
11	42	XW7B2(109LA)		10/86-06/88	T20EPR-U	5032	0.8	T20TT	IT20TT	IT20TT	4
14	55	KDZ (TU3M/Z)		01/89-02/93	K20TXR	5063	1.0	K20TT	IK20TT	IK20TT	4
14	55	KDY (TU3M)		01/89-02/93	Q16PR-U	3137	0.8	Q16TT	IQ16TT	IQ16TT	4
14	47	K1H (TU3A)		01/89-12/89	Q20P-U	3125	0.8	Q20TT	IQ20TT	IQ20TT	4
14	53	150C	Ch: Org Nr.4193>	01/86-02/93	Q20P-U	3125	0.8	Q20TT	IQ20TT	IQ20TT	4
14 E	59			10/85-05/89	Q20PR-U	3007	0.8	Q20TT	IQ20TT	IQ20TT	4
14 E	49	150F		09/85-02/93	Q20P-U	3125	0.8	Q20TT	IQ20TT	IQ20TT	4
14 E	45/53	150A; 150C	Ch: >Org Nr.4192	10/82-02/93	T20EP-U	5031	0.8	T20TT	IT20TT	IT20TT	4
14 E	52	K1G	Ch: Org Nr.4193>	04/83-07/89	Q20P-U	3125	0.8	Q20TT	IQ20TT	IQ20TT	4
15	59	B1E (XU51C)		10/87-05/92	Q20P-U	3125	0.8	Q20TT	IQ20TT	IQ20TT	4
16	58/ 65/ 68	B1A (XU51C/K); BDY (XU5M); XU52C		09/87-12/92	Q20PR-U	3007	0.8	Q20TT	IQ20TT	IQ20TT	4
16	53/64	171D; B1E (XU51C)		07/85-02/93	Q20P-U	3125	0.8	Q20TT	IQ20TT	IQ20TT	4
16	55	BAZ (XU5CP)		09/88-12/94	Q22PR-U	3010	0.8	-	-	VQ22	4
16	76	180Z		03/86-12/94	Q22P-U	3255	0.8	-	-	VQ22	4
16	66	171C	Ch: >Org Nr.4157	10/82-06/88	T22EP-U	5040	0.8	-	-	-	4
16	66	171C	Ch: Org Nr.4158>	06/85-06/88	Q20P-U	3125	0.8	Q20TT	IQ20TT	IQ20TT	4
16 E	65	BDY (XU5M)		05/89-02/93	Q20PR-U	3007	0.8	Q20TT	IQ20TT	IQ20TT	4
18 D	44	161A (XUD7)		10/85-09/93	DG-001		11V				4

	KW				Standard			Twin Tip			QTY
											
CITROËN <i>continued</i>											
BX (82-94) <i>continued</i>											
19	75/ 77/ 80/ 88	D2A (XU92C); DDZ (XU9M); DKZ (XU9JA)		07/86-12/94	Q20PR-U	3007	0.8	Q20TT	IQ20TT	IQ20TT	4
19	75	159A		07/86-05/89	T22EP-U	5040	0.8	-	-	-	4
19	70	D2C (XU92C)	Ch: >Org Nr.4578	12/87-12/89	T22EP-U	5040	0.8	-	-	-	4
19	70	D2C (XU92C)	Ch: Org Nr.4579>	09/86-11/89	IQ22	5313	0.8	-	-	VQ22	4
19 4x4	78/80	D2E; DDZ (XU9M)		06/89-05/91	Q20PR-U	3007	0.8	Q20TT	IQ20TT	IQ20TT	4
19 CAT	75	DFZ (XU9J1)	Ch: Org Nr.4228>	07/86-12/94	Q20PR-U	3007	0.8	Q20TT	IQ20TT	IQ20TT	4
19 D	47/51	162 (XUD9); D9A (XUD9); D9B (XUD9A/U); DJZ (XUD9Y)		09/83-12/94	DG-001		11V				4
19 E	80	DDZ (XU9M)		06/88-02/93	Q20PR-U	3007	0.8	Q20TT	IQ20TT	IQ20TT	4
19 E 4x4	80	D2F		04/89-02/93	Q20PR-U	3007	0.8	Q20TT	IQ20TT	IQ20TT	4
19 GTi	88	DKZ (XU9JA)		06/88-02/93	Q20PR-U	3007	0.8	Q20TT	IQ20TT	IQ20TT	4
19 GTi	90	D6A (XU9J2)		07/86-02/93	Q22P-U	3255	0.8	-	-	VQ22	4
19 GTi 16V	108	DFW (XU9J4)		03/88-02/93	K22PBR-S	5062	0.85	-	-	VK22	4
19 GTi 4x4	88	DKZ (XU9JA)		06/88-02/93	Q20PR-U	3007	0.8	Q20TT	IQ20TT	IQ20TT	4
TRD Turbo	66	A8A (XUD7TE); AJZ (XUD7TE)		03/88-12/94	DG-001		11V				4
C1 I (05-)											
1.0	50	1KR-FE		06/05-	K16HR-U11	3482	1.1	KH16TT	IKH16TT	IKH16TT	3
1.4 HDi	40	8HT (DV4TD)		06/05-	DG-113		11V				4
C1 II (14-)											
1.0	51	1KR-FE		07/14-	SC16HR11	3499	1.1	-	IXEH20TT	IXEH20TT	3
1.0 VTi 68	51			07/14-	SC16HR11	3499	1.1	-	IXEH20TT	IXEH20TT	3
C2 (03-)											
1.1	44	HFX (TU1JP)		09/03-01/10	K20PR-U	3145	0.8	K20TT	IK20TT	IK20TT	4
1.4	54/55	KFU (TU3JP)		09/03-01/10	K20PR-U	3145	0.8	K20TT	IK20TT	IK20TT	4
1.4 16V	65	KFU (ET3J4)		06/06-01/10	XE20HR-U9	3427	0.9	-	IXEH20TT	IXEH20TT	4
1.4 HDi	50	8HX (DV4TD); 8HZ (DV4TD)		09/03-	DG-113		11V				4
1.6	80	NFU (TU5JP4)		09/03-	K16HPR-U11	6076	1.1	KH16TT	IKH16TT	IKH16TT	4
1.6 HDi	80	9HZ (DV6TED4)		09/05-	DG-180		11V				4
1.6 VTS	90	NFS (TU5JP4S)	OEM Optional	01/05-	K16HPR-U11	6076	1.1	KH16TT	IKH16TT	IKH16TT	4
C3 I (02-)											
1.1 i	44	HFX (TU1A); HFX (TU1JP)		02/02-10/09	K20PR-U	3145	0.8	K20TT	IK20TT	IK20TT	4
1.4 16V	65	KFU (ET3J4)		12/03-10/09	XE20HR-U9	3427	0.9	-	IXEH20TT	IXEH20TT	4
1.4 16V HDi	66	8HY (DV4TED4)	Ch: >RPO 10226	02/02-10/04	DG-113		11V				4
1.4 16V HDi	66	8HY (DV4TED4)	Ch: RPO 10227>	11/04-	DG-180		11V				4
1.4 HDi	50	8HX (DV4TD)	Ch: >RPO 10226	02/02-10/04	DG-113		11V				4
1.4 HDi	50	8HX (DV4TD)	Ch: RPO 10227>	11/04-	DG-180		11V				4
1.4 i	54	KFV (TU3A); KFV (TU3JP)		02/02-10/09	K20PR-U	3145	0.8	K20TT	IK20TT	IK20TT	4
1.4 i Bivalent	54	KFV (TU3JP)	Flexible fuel	02/02-10/09	K20PR-U	3145	0.8	K20TT	IK20TT	IK20TT	4
1.6 16V	80/81	NFU (TU5JP4)		02/02-	K16HPR-U11	6076	1.1	KH16TT	IKH16TT	IKH16TT	4
1.6 16V HDi	80	9HZ (DV6TED4)		09/05-	DG-113		11V				4
1.6 16V HDi	80	9HZ (DV6TED4)		09/05-	DG-180		11V				4
1.6 16V HDi	66	9HX (DV6ATED4)	Ch: >RPO 10783	10/05-05/06	DG-113		11V				4
1.6 16V HDi	66	9HX (DV6ATED4)	Ch: RPO 10784>	06/06-	DG-180		11V				4
C3 II (09-)											
1.0 VTi 68	50			08/12-	IXUH22I	5356	0.9	-	-	VXUH22I	3
1.1	44	HFX (TU1JP)		11/09-	K20PR-U	3145	0.8	K20TT	IK20TT	IK20TT	4
1.1 BiFuel	44			11/10-01/11	K20PR-U	3145	0.8	K20TT	IK20TT	IK20TT	4
1.2 VTi 82	60			06/12-	IXUH22I	5356	0.9	-	-	VXUH22I	3
1.4	54	KFT (TU3A); KFV (TU3A)		11/09-	K20PR-U	3145	0.8	K20TT	IK20TT	IK20TT	4
1.4 HDi 70	50	DV4TD		11/09-	DG-180		11V				4
1.4 VTi 95	70	8FP (EP3)		11/09-	VXUH22	5611	0.9	-	-	VXUH22	4
1.6 HDi	68	9HP (DV6DTE)		11/09-	DG-180		11V				4
1.6 HDi 110	82	9HR (DV6C)		11/09-	DG-603		5V				4
1.6 HDi 115	84			09/12-	DG-603		5V				4







	KW					Standard		Twin Tip		QTY
CITROËN <i>continued</i>										
C3 II (09-) <i>continued</i>										
1.6 HDi 90	66	9HX (DV6ATED4)		11/09-	DG-180		11V			4
1.6 VTi 120	88	5FS (EP6C)		11/09-	VXUH22	5611	0.9	-	-	VXUH22
C3 Picasso (09-)										
1.4 VTi 95	70	8FN (EP3); 8FP (EP3); 8FS (EP3)		02/09-	VXUH22	5611	0.9	-	-	VXUH22
1.6 BlueHDi 100	73	BHY (DV6FD)		01/15-	DG-603		5V			4
1.6 HDi	66/80	9HX (DV6ATED4); 9HZ (DV6TED4)		02/09-	DG-180		11V			4
1.6 HDi 110	82	9HR (DV6C)		05/10-	DG-603		5V			4
1.6 HDi 115	84	9HD (DV6C)		01/13-	DG-181		11V			4
1.6 HDi 90	68	9HP (DV6DTE)		07/10-	DG-603		5V			4
1.6 VTi 120	88	5FS (EP6C); 5FW (EP6)		02/09-	VXUH22	5611	0.9	-	-	VXUH22
C3 Pluriel (03-)										
1.4	54	KFV (TU3JP)		05/03-01/11	K20PR-U	3145	0.8	K20TT	IK20TT	IK20TT
1.4 HDi	50	8HX (DV4TD)		04/04-	DG-113		11V			4
1.4 Hybrid	54	KFV (TU3JP)		05/05-01/11	K20PR-U	3145	0.8	K20TT	IK20TT	IK20TT
1.6	80	NFU (TU5JP4)		05/03-	K16HPR-U11	6076	1.1	KH16TT	IKH16TT	IKH16TT
C4 (Grand) Picasso I (06-)										
1.6 16V	103/110	5FT (EP6DT); 5FX (EP6DT)		07/08-	VXUH22	5611	0.9	-	-	VXUH22
1.6 HDi	80	9HY (DV6TED4); 9HZ (DV6TED4)		10/06-	DG-180		11V			4
1.6 HDi 110	82	9HL (DV6C)		09/10-	DG-181		11V			4
1.6 HDi 110	82	9HL (DV6C); 9HR (DV6C)		09/10-	DG-603		5V			4
1.6 THP 140	103	5FT (EP6DT)		07/08-	VXUH22	5611	0.9	-	-	VXUH22
1.6 THP 155	115	5FV (EP6CDT)		09/10-	VXUH22	5611	0.9	-	-	VXUH22
1.6 VTi 120	88	5FW (EP6)		07/08-	VXUH22	5611	0.9	-	-	VXUH22
1.8 i 16V	92	6FY (EW7A)		10/06-	K20HR-U11	3381	1.1	KH20TT	IKH20TT	IKH20TT
2.0 HDi 138	100	RHJ (DW10BTED4); RHR (DW10BTED4)		10/06-	DG-181		11V			4
2.0 HDi 150	110	RHE (DW10CTED4)		04/11-	DG-181		11V			4
2.0 HDi 165	120	RHH (DW10CTED4)		09/10-	DG-603		5V			4
2.0 i 16V	103/105	RFJ (EW10A)		02/07-	K16HPR-U11	6076	1.1	KH16TT	IKH16TT	IKH16TT
C4 (Grand) Picasso II (13-)										
1.6 BlueHDi 120	88			07/14-	DG-603		5V			4
1.6 HDi 115	85			02/13-	DG-603		5V			4
1.6 HDi 90	68	9HP (DV6DTE)		02/13-	DG-603		5V			4
1.6 VTi 120	88	5FS (EP6C)		02/13-	VXUH22	5611	0.9	-	-	VXUH22
2.0 BlueHDi 150	110			09/13-	DG-603		5V			4
C4 Aircross (12-)										
1.6	86	4A92		04/12-	VFKH16	5654	1.1	-	IKH16TT	IKH16TT
1.6 HDi 115	84	9HL (DV6C)		04/12-	DG-181		11V			4
1.6 HDi 115 AWC	84	9HL (DV6C)		05/12-	DG-181		11V			4
2.0	110	4B11		04/12-	VFK20F			-	IK20TT	IK20TT
2.0 AWC	110	4B11		04/12-	VFK20F			-	IK20TT	IK20TT
C4 Cactus (14-)										
1.6 BlueHDi 100	73			09/14-	DG-603		5V			4
1.6 HDi 90	68			09/14-	DG-603		5V			4
C4 Coupe (04-)										
1.4 16V	65	KFU (ET3J4)		11/04-06/10	XE20HR-U9	3427	0.9	-	IXEH20TT	IXEH20TT
1.6 16V	80	NFU (TU5JP4)		11/04-	K16HPR-U11	6076	1.1	KH16TT	IKH16TT	IKH16TT
1.6 HDi	66/80	9HX (DV6ATED4); 9HY (DV6TED4); 9HZ (DV6TED4)	Ch: >RPO 10783	11/04-05/06	DG-113		11V			4
1.6 HDi	66/80	9HX (DV6ATED4); 9HY (DV6TED4); 9HZ (DV6TED4)	Ch: RPO 10784>	06/06-	DG-180		11V			4
1.6 THP 150	110	5FX (EP6DT)		07/08-06/10	VXUH22	5611	0.9	-	-	VXUH22
1.6 VTi 120	88	5FW (EP6)		07/08-06/10	VXUH22	5611	0.9	-	-	VXUH22
2.0 16V	100	RFN (EW10J4)		11/04-	K16HPR-U11	6076	1.1	KH16TT	IKH16TT	IKH16TT
2.0 HDi	100	RHR (DW10BTED4)		11/04-	DG-116		11V			4
2.0 HDi	103	RHF (DW10BTED4)		07/08-06/10	DG-181		11V			4
C4 I (LC) (04-)										
1.4 16V	65	KFU (ET3J4)		11/04-01/11	XE20HR-U9	3427	0.9	-	IXEH20TT	IXEH20TT
1.6 16V	80	NFU (TU5JP4)		11/04-	K16HPR-U11	6076	1.1	KH16TT	IKH16TT	IKH16TT
1.6 16V Bio-Flex	80	NFU (TU5JP4)		09/07-	K16HPR-U11	6076	1.1	KH16TT	IKH16TT	IKH16TT







	KW					Standard			Twin Tip				QTY	
CITROËN <i>continued</i>														
C4 I (LC) (04-) continued														
1.6 HDi	80	9HY (DV6TED4); 9HZ (DV6TED4)		07/06-	DG-180		11V							4
1.6 HDi	66/80	9HX (DV6ATED4); 9HY (DV6TED4); 9HZ (DV6TED4)	Ch: >RPO 10783	11/04-05/06	DG-113		11V							4
1.6 HDi	66/80	9HX (DV6ATED4); 9HY (DV6TED4); 9HZ (DV6TED4)	Ch: RPO 10784>	06/06-	DG-180		11V							4
1.6 THP 140	103	5FT (EP6DT)		07/08-06/10	VXUH22	5611	0.9	-	-			VXUH22		4
1.6 THP 150	110	5FX (EP6DT)		07/08-06/10	VXUH22	5611	0.9	-	-			VXUH22		4
1.6 VTi 120	88	5FW (EP6)		07/08-06/10	VXUH22	5611	0.9	-	-			VXUH22		4
2.0 16V	100/103	RFJ (EW10A); RFN (EW10J4)		11/04-	K16HPR-U11	6076	1.1			KH16TT		IKH16TT		4
2.0 16V	130	RFK (EW10J4S)		11/04-01/11	K20HR-U11	3381	1.1			KH20TT		IKH20TT		4
2.0 16V	130	RFK (EW10J4S)	OEM Optional	11/04-08/05	K16HPR-U11	6076	1.1			KH16TT		IKH16TT		4
2.0 HDi	100	RHR (DW10BTED4)		11/04-	DG-116		11V							4
2.0 HDi	103	RHF (DW10BTED4)		07/08-	DG-181		11V							4
C4 II (B7) (09-)														
1.4 VTi 95	70	8FP (EP3)		11/09-	K16HPR-U11	6076	1.1			KH16TT		IKH16TT		4
1.6 BlueHDi 120	88	BHZ (DV6FC)		02/15-	DG-603		5V							4
1.6 HDi 110	82	9HR (DV6C)		11/09-	DG-603		5V							4
1.6 HDi 115	84	9HR (DV6C)		07/12-	DG-603		5V							4
1.6 HDi 90	68	9HP (DV6DTE)		11/09-	DG-180		11V							4
1.6 THP 155	115	5FV (EP6CDT)		11/09-	VXUH22	5611	0.9	-	-			VXUH22		4
1.6 VTi 120	88	5FS (EP6C)		11/09-	VXUH22	5611	0.9	-	-			VXUH22		4
1.6 VTi 120 LPG	88	5FS (EP6C)		09/11-	VXUH22	5611	0.9	-	-			VXUH22		4
2.0 BlueHDi 150	110	RHE (DW10CTED4)		11/09-	DG-181		11V							4
C5 I (01-04)														
1.8 16V (DC6FZB, DC6FZE)	85	6FZ (EW7J4)		03/01-08/04	K20HR-U11	3381	1.1			KH20TT		IKH20TT		4
1.8 16V (DE6FZB, DE6FZE)	85	6FZ (EW7J4)		06/01-08/04	K20HR-U11	3381	1.1			KH20TT		IKH20TT		4
2.0 16V (DCRFNC, DCRFNF)	100	RFN (EW10J4)		03/01-08/04	K16HPR-U11	6076	1.1			KH16TT		IKH16TT		4
2.0 16V (DERFNF, DERFNC, RERFNC)	100	RFN (EW10J4)		06/01-08/04	K16HPR-U11	6076	1.1			KH16TT		IKH16TT		4
2.0 16V HPI (DCRLZB)	103	RLZ (EW10D)		03/01-08/04	K16HPR-U11	6076	1.1			KH16TT		IKH16TT		4
2.0 16V HPI (DERLZB)	103	RLZ (EW10D)		06/01-08/04	K16HPR-U11	6076	1.1			KH16TT		IKH16TT		4
2.0 HDi	79/80	RHS (DW10ATED); RHZ (DW10ATED)		03/01-08/04	DG-116		11V							4
2.0 HDi (DCRHYB)	66	RHY (DW10TD)		03/01-08/04	DG-116		11V							4
2.0 HDi (DCRHZB, DCRHZE)	80	RHZ (DW10ATED)		03/01-08/04	DG-116		11V							4
2.0 HDi (DERHSB, DERHSE)	79	RHS (DW10ATED); RHZ (DW10ATED)		06/01-08/04	DG-116		11V							4
2.0 HDi (DERHYB)	66	RHY (DW10TD)		06/01-08/04	DG-116		11V							4
2.2 HDi (DC4HXB, DC4HXE)	98	4HX (DW12TED4/FAP)	Ch: >RPO 09666	03/01-04/03	DG-116		11V							4
2.2 HDi (DC4HXB, DC4HXE)	98	4HX (DW12TED4/FAP)	Ch: RPO 09667>	05/03-08/04	DG-181		11V							4
2.2 HDi (DC4HXB, DC4HXE)	98	4HX (DW12TED4/FAP)	Ch: RPO 09702>	06/03-08/04	DG-181		11V							4
2.2 HDi (DE4HXB, DE4HXE)	98	4HX (DW12TED4/FAP)	Ch: >RPO 09666	06/01-04/03	DG-116		11V							4
2.2 HDi (DE4HXB, DE4HXE)	98	4HX (DW12TED4/FAP)	Ch: RPO 09667>	05/03-08/04	DG-181		11V							4
2.2 HDi (DE4HXB, DE4HXE)	98	4HX (DW12TED4/FAP)	Ch: RPO 09702>	06/03-08/04	DG-181		11V							4
3.0 V6 (DCXFXC, DCXFXF)	152	XFX (ES9J4S)		03/01-08/04	VKH16	5617	1.1	-				IKH16TT		6
3.0 V6 (DEXFXC, DEXFXF)	152	XFX (ES9J4S)		06/01-08/04	VKH16	5617	1.1	-				IKH16TT		6
C5 II (04-)														
1.6 HDi (RC8HZB)	80	9HY (DV6TED4); 9HZ (DV6TED4)	Ch: >ORP 10783	09/04-05/06	DG-113		11V							4
1.6 HDi (RC8HZB)	80	9HY (DV6TED4); 9HZ (DV6TED4)	Ch: ORP 10784>	05/06-	DG-180		11V							4
1.6 HDi (RE8HZB)	80	9HY (DV6TED4); 9HZ (DV6TED4)	Ch: >ORP 10783	09/04-05/06	DG-113		11V							4
1.6 HDi (RE8HZB)	80	9HY (DV6TED4); 9HZ (DV6TED4)	Ch: ORP 10784>	05/06-	DG-180		11V							4
1.8 16V	92	6FY (EW7A)		09/05-03/08	K20HR-U11	3381	1.1			KH20TT		IKH20TT		4
1.8 16V (RC6FZB)	85	6FZ (EW7J4)		09/04-12/05	K20HR-U11	3381	1.1			KH20TT		IKH20TT		4
1.8 16V (RE6FZB)	85	6FZ (EW7J4)		09/04-12/05	K20HR-U11	3381	1.1			KH20TT		IKH20TT		4







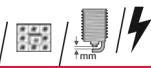



	KW								QTY		
CITROËN <i>continued</i>											
C5 II (04-) <i>continued</i>											
2.0 16V (RCRFJB, RCRFJC)	103	RFJ (EW10A)		09/04-	K16HPR-U11	6076	1.1	KH16TT	IKH16TT	IKH16TT	4
2.0 16V (RERFJB, RERFJC)	103	RFJ (EW10A)		09/04-	K16HPR-U11	6076	1.1	KH16TT	IKH16TT	IKH16TT	4
2.0 HDi (RCRHRH)	100	RHR (DW10BTED4)		09/04-	DG-181		11V				4
2.0 HDi (RERHRH)	100	RHR (DW10BTED4)		09/04-	DG-181		11V				4
2.2 HDi	125	4HT (DW12BTED4)		04/06-03/08	DG-180		11V				4
2.2 HDi (RC4HXE)	98	DW12TED4		09/04-	DG-181		11V				4
2.2 HDi (RE4HXE)	98	DW12TED4		09/04-	DG-181		11V				4
3.0 V6 (RCXFUF)	152	ES9A(XFU);ES9A(XFV)		09/04-03/08	VKH16	5617	1.1	-	IKH16TT	IKH16TT	6
3.0 V6 (REXFUF)	152	XFU (ES9A)		09/04-06/08	VKH16	5617	1.1	-	IKH16TT	IKH16TT	6
C5 III (08-)											
1.6 HDi	80	9HZ (DV6TED4)		02/08-	DG-180		11V				4
1.6 HDi 110	82	9HR (DV6C)		07/10-	DG-603		5V				4
1.6 HDi 115	84	9HR (DV6C)		01/12-	DG-603		5V				4
1.6 THP 155	115	5FV (EP6GDT); 5FV (EP6DT)		04/09-	VXUH22	5611	0.9	-	-	VXUH22	4
1.6 VTI 120	88	5FS (EP6C)		07/10-	VXUH22	5611	0.9	-	-	VXUH22	4
1.8 16V	92	6FY (EW7A)		02/08-	K20HR-U11	3381	1.1	KH20TT	IKH20TT	IKH20TT	4
2.0 16V	103	RFJ (EW10A)		02/08-	K16HPR-U11	6076	1.1	KH16TT	IKH16TT	IKH16TT	4
2.0 16V BioFlex	103	RFJ (EW10A)		02/08-	K20HR-U11	3381	1.1	KH20TT	IKH20TT	IKH20TT	4
2.0 BlueHDi 150	110	RHE (DW10CTED4)		04/09-	DG-603		5V				4
2.0 HDi	100	RHF (DW10BTED4); RHR (DW10BTED4)		02/08-	DG-181		11V				4
2.0 HDi 140	103	DW10BTED4/F		04/09-	DG-181		11V				4
2.0 HDi 165	120	RHH (DW10CTED4)		04/09-	DG-603		5V				4
2.2 HDi	125	4HT (DW12BTED4)		02/08-	DG-614		11V				4
2.2 HDi 165	120	4HP (DW12BTED4)		02/08-09/09	DG-614		11V				4
2.7 HDi	150	DT17TED4		02/08-	DG-140		11V				6
3.0 V6	155	ES9A(XFV)		02/08-	VKH16	5617	1.1	-	IKH16TT	IKH16TT	6
C6 (05-)											
2.2 HDi	120/125	4HP (DW12BTED4); 4HT (DW12BTED4)		06/06-	DG-614		11V				4
2.7 HDi	150	DT17ED4; UHZ (DT17BTED4)		09/05-	DG-140		11V				6
3.0 V6	155	ES9A(XFV)		09/05-	VKH16	5617	1.1	-	IKH16TT	IKH16TT	6
C8 (02-)											
2.0	100	RFN (EW10J4)		07/02-	K16HPR-U11	6076	1.1	KH16TT	IKH16TT	IKH16TT	4
2.0 16V	103/104	RFJ (EW10A)		09/05-	K16HPR-U11	6076	1.1	KH16TT	IKH16TT	IKH16TT	4
2.0 HDi	80	RHW (DW10ATED4)		07/02-04/06	DG-116		11V				4
2.0 HDi	88	RHK (DW10UTED4)		02/07-	DG-181		11V				4
2.0 HDi	79	RHM (DW10ATED4); RHT (DW10ATED4)	Eng: >9666	07/02-04/03	DG-116		11V				4
2.0 HDi	79	RHM (DW10ATED4); RHT (DW10ATED4)	Eng: 9667>	05/03-12/06	DG-181		11V				4
2.0 HDi 135	100	RHD (DW10CB); RHD (DW10CTED4); RHR (DW10BTED4)		03/06-	DG-181		11V				4
2.0 HDi 165	120	RHE (DW10CTED4); RHH (DW10CTED4)		03/06-	DG-603		5V				4
2.2	116	3FZ (EW12J4)		07/02-09/05	K20HR-U11	3381	1.1	KH20TT	IKH20TT	IKH20TT	4
2.2 HDi	94	4HW (DW12TED4)		07/02-	DG-116		11V				4
2.2 HDi	125	4HT (DW12BTED4)	OE: 5960-G6;5960-99;5960-A0	06/06-	DG-614		11V				4
2.2 HDi	125	4HT (DW12BTED4)	OE: E161042	06/06-12/08	DG-116		11V				4
3.0 V6	150	ES9J4S(XFW)		07/02-09/05	VKH16	5617	1.1	-	IKH16TT	IKH16TT	6
C15 (84-05)											
1.0	33	TU9		10/84-12/97	Q20PR-U	3007	0.8	Q20TT	IQ20TT	IQ20TT	4
1.1	40/44	HDZ (TU1M); TU1(H1A) - K		10/88-07/96	K20PR-U	3145	0.8	K20TT	IK20TT	IK20TT	4
1.1	35	109K		10/84-12/96	T20EP-U	5031	0.8	T20TT	IT20TT	IT20TT	4
1.1	40	H1A	Ch: Org Nr.4205>	11/88-07/96	Q20P-U	3125	0.8	Q20TT	IQ20TT	IQ20TT	4
1.1 i	44	HDZ (TU1M)		07/88-12/96	K20TXR	5063	1.0	K20TT	IK20TT	IK20TT	4
1.3	47	G1A		07/87-05/88	K20PR-U	3145	0.8	K20TT	IK20TT	IK20TT	4
1.4	49/55	TU3.2(K2D) - K; TU3A(K1G) - K		05/87-07/96	K20PR-U	3145	0.8	K20TT	IK20TT	IK20TT	4
1.4	49	K1H (TU3A)		07/87-12/96	Q20P-U	3125	0.8	Q20TT	IQ20TT	IQ20TT	4
1.4 E	40	K3A		07/87-12/96	Q20P-U	3125	0.8	Q20TT	IQ20TT	IQ20TT	4
1.4 E	44	150D (XY7)		05/87-09/87	T20EP-U	5031	0.8	T20TT	IT20TT	IT20TT	4







Spark & Glow Plugs







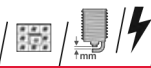



Application Tables







	KW				Standard 			Twin Tip 			QTY
CITROËN <i>continued</i>											
C15 (84-05) <i>continued</i>											
1.4 i	55	KDY (TU3M)		05/91-12/96	Q20PR-U	3007	0.8	Q20TT	IQ20TT	IQ20TT	4
1.8 D	44	161A (XUD7)		07/86-12/00	DG-001		11V				4
1.9 D	44	WJX (DW8B)		12/00-12/05	DG-001		11V				4
C25 (81-94)											
1.8	50	169 (XM7T)		07/87-01/94	W20EP-U	3043	0.8	W20TT	IW20TT	IW20TT	4
1.8 E	51	169 (XM7T)		07/87-02/94	IW20	5306	1.1	-	IW20TT	IW20TT	4
1.9 D	51	D9B (XUD9A/U)		07/87-02/94	DG-001		11V				4
1.9 D 1400	51	DJY (XUD9A)		01/88-01/94	DG-001		11V				4
1.9 TD	60	M705		04/92-02/94	DG-001		11V				4
2.0	57	XN1T(106)		11/81-12/86	IW20	5306	1.1	-	IW20TT	IW20TT	4
2.0	62	170C (XN1T)		01/87-03/94	W20EP-U	3043	0.8	W20TT	IW20TT	IW20TT	4
2.0 E	58	170A (XN1T); 170B (XN1T)		07/83-03/94	IW20	5306	1.1	-	IW20TT	IW20TT	4
2.0 E	58	170B		09/81-12/86	W20EP-U	3043	0.8	W20TT	IW20TT	IW20TT	4
2.5 D	54	CRD93L (U25-661)		10/85-02/94	DG-001		11V				4
2.5 D 4x4	54	CRD93L (U25-661)		01/87-02/94	DG-001		11V				4
2.5 D Turbo	70	CRD93LS (U25-673)		08/87-02/94	DG-001		11V				4
2.5 D Turbo 4x4	70	CRD93LS (U25-673)		08/87-02/94	DG-001		11V				4
2.5 DT	70	CRD93LS (U25-673)		01/87-01/94	DG-001		11V				4
C35 (73-94)											
2.0	65	B20614		11/73-01/94	W20FP-U	3068	0.7	WF20TT	-	-	4
2.2 D	45	B22615		11/73-01/80	DG-001		11V				4
2.5 D	51	B25637		02/80-01/94	DG-001		11V				4
C-CROSSER (07-)											
2.0	108	4B11		11/10-	VFK20F			-	IK20TT	IK20TT	4
2.0 All-wheel Drive	108	4B11		11/10-	VFK20F			-	IK20TT	IK20TT	4
2.2 HDi	115	4HN (DW12MTED4)		02/07-	DG-614		11V				4
2.4 16V	125	4B12; SFZ (4B12-MMC)		08/08-06/10	K16PSR-B8	3437	0.8	-	IK16TT	IK16TT	4
C-ELYSEE (12-)											
1.2 VTi 72	53			11/12-	IXUH22I	5356	0.9	-	-	VXUH22I	3
1.6 HDi 92	68	9HR (DV6C)		11/12-	DG-603		5V				4
1.6 VTi 115	85	NFP (EC5)		11/12-	K16HPR-U11	6076	1.1	KH16TT	IKH16TT	IKH16TT	4
CX I (74-85)											
25 D Turbo	70	M25-648		04/83-08/85	DG-001		11V				4
25 TRi	100	M25-659		07/83-08/85	W20FP-U	3068	0.7	WF20TT	-	-	4
25 TRI	100	M25-659		07/83-08/85	W22FPR-U	4022	0.7	-	-	-	4
2000	78	829 A5		06/79-08/85	T20EP-U	5031	0.8	T20TT	IT20TT	IT20TT	4
2000	75	M20-616		09/75-05/79	W20FP-U	3068	0.7	WF20TT	-	-	4
2200	85	J6T A500		06/81-08/85	T22EP-U	5040	0.8	-	-	-	4
2200	82	M20/616		09/74-07/76	W20FPR-U	3070	0.7	WF20TT	-	-	4
2400	85/88	M23-623; M23-639		08/76-05/82	W20FP-U	3068	0.7	WF20TT	-	-	4
2400 GTi	94/96	M23-622		06/77-06/82	W20FP-U	3068	0.7	WF20TT	-	-	4
2500 D	55	M25-629		02/78-08/85	DG-001		11V				4
2500 D Turbo	70	M25-648		04/83-08/85	DG-001		11V				4
CX II (85-92)											
20	78	829 A5		08/85-08/86	T20EP-U	5031	0.8	T20TT	IT20TT	IT20TT	4
20 RE	78	829 A5		08/85-12/92	T20EP-U	5031	0.8	T20TT	IT20TT	IT20TT	4
22 TRS	83/85	J6T A500		07/85-12/92	T22EP-U	5040	0.8	-	-	-	4
22TRS	85	J6T A500		07/85-07/89	T22EP-U	5040	0.8	-	-	-	4
25 D	54	M25-660		08/85-12/92	DG-001		11V				4
25 D Turbo	70/88	M25-648; M25-669		08/85-12/92	DG-001		11V				4
25 D Turbo 2	88	M25-669		01/87-12/92	DG-001		11V				4
25 GTi	89	M25-668		05/86-12/86	W20FPR-U	3070	0.7	WF20TT	-	-	4
25 i	89	M25-668		05/86-12/92	W20FPR-U	3070	0.7	WF20TT	-	-	4
25 TRi	100	M25-659		08/85-07/89	W20FP-U	3068	0.7	WF20TT	-	-	4
25 TRI	100	M25-659		08/85-07/89	W22FPR-U	4022	0.7	-	-	-	4
2500 D Turbo	70	M25-648		08/85-12/86	DG-001		11V				4
DS3 (09-)											
1.2 VTi 82	60			01/13-	IXUH22I	5356	0.9	-	-	VXUH22I	3
1.4 HDi 70	50	8HR (DV4C)		04/10-	DG-603		5V				4
1.4 VTi 95	70	EP3C - E5		04/10-	VXUH22	5611	0.9	-	-	VXUH22	4
1.4 VTi 95	70	EP3C	Flexible fuel	07/11-	VXUH22	5611	0.9	-	-	VXUH22	4
1.6 BlueHDi 100	73	BHY (DV6FD)		07/14-	DG-603		5V				4
1.6 BlueHDi 120	88	BHZ (DV6FC)		10/13-	DG-603		5V				4
1.6 HDi 110	82	9HR (DV6C)		11/09-	DG-603		5V				4
1.6 HDi 115	84	9HL (DV6C)		08/12-	DG-181		11V				4
1.6 HDi 115	85	BHX (DV6FC)		10/13-	DG-603		5V				4







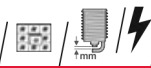



	KW								QTY
CITROËN <i>continued</i>									
DS3 (09-) <i>continued</i>									
1.6 HDi 90	68/69	9HP (DV6DTEd)		11/09-	DG-603		5V		4
1.6 THP 150	110	5FN (EP6CDT); 5FX (EP6DT)		01/10-	VXUH22	5611	0.9	-	4
1.6 THP 155	115	5FR (EP6DT); 5FV (EP6CDT)		04/10-	VXUH22	5611	0.9	-	4
1.6 VTi 120	88	5FS (EP6C)		04/10-	VXUH22	5611	0.9	-	4
DS4 (11-)									
1.6 HDi 110	81/82	9HR (DV6C)		04/11-	DG-603		5V		4
1.6 HDi 115	84	9HL (DV6C)		08/12-	DG-181		11V		4
1.6 HDi 90	68	9HP (DV6DTEd)		05/11-	DG-603		5V		4
1.6 THP 155	115	5FV (EP6CDT)		04/11-	VXUH22	5611	0.9	-	4
1.6 THP 200	147	5FU (EP6DTX)		04/11-	VXUH22	5611	0.9	-	4
1.6 VTi 120	88	5FS (EP6C)		04/11-	VXUH22	5611	0.9	-	4
2.0 HDi 135	100			09/11-	DG-603		5V		4
2.0 HDi 165	120	RHH (DW10CTED4)		04/11-	DG-603		5V		4
DS5 (11-)									
1.6 BlueHDi 120	88	BHZ (DV6FC)		07/14-	DG-603		5V		4
1.6 HDi	85	BHX (DV6FC)		11/13-	DG-603		5V		4
1.6 HDi 110	82	9HR (DV6C)		11/11-	DG-603		5V		4
1.6 HDi 115	84			06/12-	DG-603		5V		4
1.6 THP 155	115	5FV (EP6CDT)		11/11-	VXUH22	5611	0.9	-	4
1.6 THP 200	147	5FU (EP6DTX)		11/11-	VXUH22	5611	0.9	-	4
2.0 BlueHDi 180	133			08/13-	DG-603		5V		4
2.0 HDi 135	100			11/11-	DG-603		5V		4
2.0 HDi 165	120	RHH (DW10CTED4)		11/11-	DG-603		5V		4
2.0 HDi 165 Hybrid4 4x4	120	RHC (DW10CTED4)		12/11-	DG-603		5V		4
DYANE (67-84)									
6	21	M28 (AM2)		12/68-10/84	W20FPR-U	3070	0.7	WF20TT	2
6	24	M28/1 (AK2)		05/72-12/80	W20FSR-U	6053	0.7	WF20TT	2
EVASION (94-02)									
1.8	73/76	LFZ (XU7JP)		02/96-07/02	K20TXR	5063	1.0	K20TT	4
1.9 TD	66/68	D8B (XUD9TF); DHX (XUD9TF/BTF)		11/94-07/02	DG-001		11V		4
2.0	89	RFU (XU10J2/C)		06/94-07/02	Q20PR-U	3007	0.8	Q20TT	4
2.0 16V	100	RFN (EW10J4)		05/00-07/02	K16HPR-U11	6076	1.1	KH16TT	4
2.0 16V	97	RFV (XU10J4R)		05/98-04/00	K20TXR	5063	1.0	K20TT	4
2.0 HDi	80	RHZ (DW10ATED)		08/99-07/02	DG-116		11V		4
2.0 HDi 16V	80	RHW (DW10ATED4)		09/99-07/02	DG-116		11V		4
2.0 Turbo C.T.	108	RGX (XU10J2TE)		06/94-07/02	K20PR-U	3145	0.8	K20TT	4
2.1 TD	80	P8C (XUD11BTE)		05/97-07/02	DG-001		11V		4
GS (70-86)									
1.0	40	G10/612; G10		09/70-09/77	W20EPR-U	3047	0.8	W20TT	4
1.2	43	G12/611; G12/612		04/73-06/79	T20EPR-U	5032	0.8	T20TT	4
A 1.2	43	G12/611; G12/612		04/73-06/79	T20EPR-U	5032	0.8	T20TT	4
A 1.3	48	G11/646; G13/625		09/79-07/86	T20EPR-U	5032	0.8	T20TT	4
X 2	46	G12/619		09/75-07/79	T20EPR-U	5032	0.8	T20TT	4
HY (69-77)									
1.9	41	1911		11/69-08/77	W20FPR-U	3070	0.7	WF20TT	4
JUMPER (94-02)									
1.9 D	50/51	D9B (XUD9A/U); DJY (XUD9A)		02/94-04/02	DG-001		11V		4
1.9 TD	66/68	D8C (XUD9UTF); DHX (XUD9TF/BTF)		03/94-04/02	DG-001		11V		4
1.9 TD 4x4	68	D8C (XUD9UTF)		08/96-04/02	DG-001		11V		4
2.0	80	RFW (XU10J2U)		02/94-04/02	K20TXR	5063	1.0	K20TT	4
2.0	80	RFW (XU10J2U)		03/94-04/02	Q20PR-U	3007	0.8	Q20TT	4
2.0 4x4	80	RFW (XU10J2U)		10/96-01/02	K20PR-U	3145	0.8	K20TT	4
2.0 4x4	80	RFW (XU10J2U)		08/96-04/02	Q20PR-U	3007	0.8	Q20TT	4
2.0 HDi	62	RHV (DW10UTD)		11/01-04/02	DG-116		11V		4
2.5 D	63	T9A (DJ5)		03/94-04/02	DG-001		11V		4
2.5 D 4X4	63	T9A (DJ5)		08/96-04/02	DG-001		11V		4
2.5 TD	76	T8A (DJ5T)		03/94-04/02	DG-001		11V		4
2.5 TD 4x4	76	T8A (DJ5T)		08/96-04/02	DG-001		11V		4
2.5 TDi	79	THX (DJ5TED)		12/96-04/02	DG-161		11V		4
2.5 TDi 4X4	79	THX (DJ5TED)		12/96-04/02	DG-161		11V		4
2.8 HDi	93/94	8140.43S		09/00-04/02	DG-111		11V		4
2.8 HDi 4x4	94	8140.43S		09/00-04/02	DG-111		11V		4

	KW										QTY
CITROËN <i>continued</i>											
JUMPER (02-)											
2.0	81	XU10J2U(RFW)		04/02-06/06	K20PR-U	3145	0.8	K20TT	IK20TT	IK20TT	4
2.0 bivalent	81	XU10J2U(RFW)(GNV)	Flexible fuel	02/03-06/06	K20PR-U	3145	0.8	K20TT	IK20TT	IK20TT	4
2.0 HDi	62	RHV (DW10TD); RHV (DW10UTD)		04/02-	DG-116		11V				4
2.2 HDi	74	4HY (DW12UTED)		02/02-	DG-116		11V				4
2.8 HDi	94/107	8140.43N; 8140.43S		04/02-	DG-111		11V				4
2.8 HDi 4x4	94	8140.43S		04/02-	DG-111		11V				4
JUMPER (06-)											
2.2 HDi 100	74	4HV (P22DTE)		04/06-	DG-130		11.5V				4
2.2 HDi 120	88	4HU (P22DTE)		04/06-	DG-130		11.5V				4
3.0 HDi 145	107	F1CE3481N		07/10-	DG-195		11V				4
3.0 HDi 160	116	F1CE0481D (F30DT)		09/06-	DG-195		11V				4
3.0 HDi 180	130			07/11-	DG-195		11V				4
JUMPY (95-)											
1.6	58	160A - L; 160A - L3; 160A - W2, 160A - W3		10/95-12/03	Q20PR-U	3007	0.8	Q20TT	IQ20TT	IQ20TT	4
1.6 i	58	220 A2.000		10/95-	Q20PR-U	3007	0.8	Q20TT	IQ20TT	IQ20TT	4
1.9 D	51	D9B (XUD9A/U); XUD9A(D9B)		10/95-08/98	DG-001		11V				4
1.9 D 70	51	WJY (DW8B); WJZ (DW8)		04/98-	DG-003		11V				4
1.9 TD	66/68	D8B (XUD9TF); DHX (XUD9TF/BTF)		10/95-	DG-001		11V				4
2.0	100	RFN (EW10J4)		04/00-12/06	K16HPR-U11	6076	1.1	KH16TT	IKH16TT	IKH16TT	4
2.0	100	RFN (EW10J4)		12/03-10/06	K20HR-U11	3381	1.1	KH20TT	IKH20TT	IKH20TT	4
2.0 HDi 110	80	RHW (DW10ATED4); RHZ (DW10ATED)		03/00-	DG-116		11V				4
2.0 HDi 110	80	RHW (DW10ATED4)		04/03-12/03	DG-181		11V				4
2.0 HDi 110	80	RHW (DW10ATED4)	OE: 5960F4	04/03-12/03	DG-181		11V				4
2.0 HDi 110	80	RHW (DW10ATED4)	OE: 5960F5	06/01-12/03	DG-116		11V				4
2.0 HDi 110 16V	80	RHZ (DW10ATED)		12/03-10/06	DG-116		11V				4
2.0 HDi 95	69	RHX (DW10BTED)		10/99-	DG-116		11V				4
2.0 i 16V	102	EW10J4(RFN) - D4; EW10J4(RFN) - D4; EW10J4(RFN)		03/00-12/06	K20HR-U11	3381	1.1	KH20TT	IKH20TT	IKH20TT	4
JUMPY (07-)											
1.6 HDi 90 16V	66	9HU (DV6UTED4)		01/07-	DG-180		11V				4
1.6 HDi 90 8V	66	9HH (DV6DUM); 9HM (DV6UC)		01/07-	DG-603		5V				4
2.0 HDi 120	88	RHK (DW10UTED4)		01/07-	DG-181		11V				4
2.0 HDi 125	94			07/11-	DG-603		5V				4
2.0 HDi 140	100	RHR (DW10BTED4)		01/07-	DG-181		11V				4
2.0 HDi 165	120	RHH (DW10CTED4)		07/10-	DG-603		5V				4
2.0 HDi 95	72			07/11-	DG-603		5V				4
2.0 i	103	EW10A(RFJ); RFH (EW10A)		01/07-	K20HR-U11	3381	1.1	KH20TT	IKH20TT	IKH20TT	4
LNA (76-86)											
0.6	26	V06 630; V06 644		11/78-07/86	T20EPR-U	5032	0.8	T20TT	IT20TT	IT20TT	2
0.6	24	R06 627		11/76-07/79	W20FS-U	3073	0.7	WF20TT	-	-	2
1.1	37	109/5E		07/82-04/85	T20EP-U	5031	0.8	T20TT	IT20TT	IT20TT	4
MEHARI (68-87)											
4x4	21	A06/635		10/79-10/87	W20FSR-U	6053	0.7	WF20TT	-	-	2
NEMO (08-)											
1.3 HDi 75	55	FHZ (F13DTE5)		10/10-	DG-171		11V				4
1.4	54	KFT (TU3A); KFV (TU3A)		02/08-	K20PR-U	3145	0.8	K20TT	IK20TT	IK20TT	4
1.4 HDi	50	8HS (DV4TED)		02/08-	DG-180		11V				4
SAXO (96-04)											
1.0 X	33/37	CDZ (TU9M)		05/96-06/03	K20TXR	5063	1.0	K20TT	IK20TT	IK20TT	4
1.1 X, SX	40/44	HDZ (TU1M)		05/96-09/03	K20TXR	5063	1.0	K20TT	IK20TT	IK20TT	4
1.4 VTS	55	KFX (TU3JP)		05/96-06/03	K20PR-U	3145	0.8	K20TT	IK20TT	IK20TT	4
1.5 D	40/42/43	VJY (TUD5); VJZ (TUD5)		09/96-04/04	DG-003		11V				4
1.6	74	NFT		02/01-04/04	K20TNR	3304	1.0	K20TT	IK20TT	IK20TT	4
1.6	88	NFX (TU5JP4)		02/96-04/04	K20TNR-S9	3305	0.9	K20TT	IK20TT	IK20TT	4
1.6	66	NFZ (TU5JP)		02/96-06/03	K20TXR	5063	1.0	K20TT	IK20TT	IK20TT	4
1.6 VTL, VTR	65	NFZ (TU5JP)		05/96-06/03	K20TXR	5063	1.0	K20TT	IK20TT	IK20TT	4
1.6 VTS	72	NFT		09/00-09/03	K20PR-U	3145	0.8	K20TT	IK20TT	IK20TT	4

	KW								QTY		
CITROËN <i>continued</i>											
SAXO (96-04) <i>continued</i>											
1.6 VTS	87	NFX (TU5JP4)		06/96-09/03	K20TXR	5063	1.0	K20TT	IK20TT	IK20TT	4
VISA (78-91)											
0.6	24/25	V06 630; V06/665		09/78-06/88	T22EP-U	5040	0.8	-	-	-	2
1.0	33	XV8		09/84-06/88	T20EP-U	5031	0.8	T20TT	IT20TT	IT20TT	4
11 E	35/ 37/ 42	109/5F; 109K		09/78-03/91	T20EP-U	5031	0.8	T20TT	IT20TT	IT20TT	4
11 RE	37	109/5F		03/83-10/88	T20EP-U	5031	0.8	T20TT	IT20TT	IT20TT	4
14	44	150D (XY7)		07/84-03/91	T22EP-U	5040	0.8	-	-	-	4
14 GT	55/58	150B (XY8)		03/82-03/91	T22EP-U	5040	0.8	-	-	-	4
16 GTI	83	B6D		06/86-03/91	Q22P-U	3255	0.8	-	-	VQ22	4
16 GTI	76	180A (XU5J)		01/85-06/86	T22EP-U	5040	0.8	-	-	-	4
17 D	44	161A (XUD7)		04/84-03/91	DG-001		11V				4
II Super X	47	129/5		07/80-06/82	T20EP-U	5031	0.8	T20TT	IT20TT	IT20TT	4
XANTIA (93-98)											
1.6 i	65	BFZ (XU5JP)		03/93-01/98	K20TXR	5063	1.0	K20TT	IK20TT	IK20TT	4
1.8 i	66/74	LFX (XU7JB); LFZ (XU7JP)		06/95-01/98	K20TXR	5063	1.0	K20TT	IK20TT	IK20TT	4
1.8 i 16V	81	LFY (XU7JP4)		06/95-01/98	K20TXR	5063	1.0	K20TT	IK20TT	IK20TT	4
1.9 D	50/51	D9B (XUD9A/L); DJZ (XUD9Y)		06/94-01/98	DG-001		11V				4
1.9 SD	55	DHW (XUD9SD)		02/96-01/98	DG-001		11V				4
1.9 Turbo D	66	D8B (XUD9TF); DHX (XUD9TF/BTF); DHY (XUD9TE/Y)		10/94-01/98	DG-001		11V				4
2.0 i	89	RFX (XU10J2C)		03/93-01/98	K20TXR	5063	1.0	K20TT	IK20TT	IK20TT	4
2.0 i 16V	110/ 112	RFT (XU10J4/Z); RFY (XU10J4/Z)		03/93-01/98	K20PR-U	3145	0.8	K20TT	IK20TT	IK20TT	4
2.0 i 16V	97	RFV (XU10J4R)		06/95-01/98	K20TXR	5063	1.0	K20TT	IK20TT	IK20TT	4
2.0 Turbo	108	RGX (XU10J2TE)		06/95-01/98	K20PR-U	3145	0.8	K20TT	IK20TT	IK20TT	4
2.1 Turbo D 12V	80	P8C (XUD11BTE)		06/95-01/98	DG-001		11V				4
3.0 i 24V	140	XFZ (ES9J4)		01/97-01/98	K20TXR	5063	1.0	K20TT	IK20TT	IK20TT	6
XANTIA (98-03)											
1.6 i SX	65	XU5JP(BFZ) - L3		01/98-03/01	K20PR-U	3145	0.8	K20TT	IK20TT	IK20TT	4
1.8 i	66	XU7JB(LFX) - L3		01/98-04/03	K20PR-U	3145	0.8	K20TT	IK20TT	IK20TT	4
1.8 i 16V	81	LFY (XU7JP4); XU7JP4(LFY) - L3; XU7JP4(LFY)JF		01/98-04/03	K20PR-U	3145	0.8	K20TT	IK20TT	IK20TT	4
1.8 i 16V	81	LFY (XU7JP4)	Flexible fuel	01/98-04/03	K20PR-U	3145	0.8	K20TT	IK20TT	IK20TT	4
1.9 SD	55	DHW (XUD9SD)		01/98-04/03	DG-001		11V				4
1.9 Turbo D	66	D8B (XUD9TF); DHX (XUD9TF/BTF); DHY (XUD9TE/Y)		01/98-04/03	DG-001		11V				4
2.0 HDI 109	80	RHZ (DW10ATED)		02/99-04/03	DG-116		11V				4
2.0 HDI 90	66	RHY (DW10TD)		03/99-04/03	DG-116		11V				4
2.0 i	89	XU10J2C(RFX) - L3		01/98-04/03	K20PR-U	3145	0.8	K20TT	IK20TT	IK20TT	4
2.0 i 16V	97	XU10J4R(RFV) - D3; XU10J4R(RFV) - K; XU10J4R(RFV) - L3		01/98-04/03	K20PR-U	3145	0.8	K20TT	IK20TT	IK20TT	4
2.0 Turbo	108	XU10J2TE(RGX) - L3		01/98-04/03	K20PR-U	3145	0.8	K20TT	IK20TT	IK20TT	4
2.1 Turbo D 12V	80	P8C (XUD11BTE)		01/98-02/99	DG-001		11V				4
3.0 V6	140	ES9J4(XFZ) - L3		01/98-04/03	K20TXR	5063	1.0	K20TT	IK20TT	IK20TT	6
XM (89-94)											
2.0	94	XU10J2(R6A) - K		05/89-06/94	Q20PR-U	3007	0.8	Q20TT	IQ20TT	IQ20TT	4
2.0	84			05/89-12/92	Q22PR-U	3010	0.8	-	-	VQ22	4
2.0 i	79/89	RDZ (XU10MZ); RFZ (XU10J2)		05/89-04/94	Q20PR-U	3007	0.8	Q20TT	IQ20TT	IQ20TT	4
2.1 D 12V	60	P9A (XUD11A)		05/89-06/94	DG-001		11V				4
2.1 TD 12V	80	P8A (XUD11ATE); P8C (XUD11BTE); PHZ (XUD11ATE); PJZ (XUD11ATE)		05/89-06/94	DG-001		11V				4
3.0	123	ZPJ(S6A) - K		05/89-05/94	K20PBR	5060	0.85	K20TT	IK20TT	IK20TT	6
3.0 V6	123	UFZ (ZPJ/Z)		05/89-06/94	K20PBR	5060	0.85	K20TT	IK20TT	IK20TT	6
3.0 V6	123	UFZ (ZPJ/Z)		11/91-04/94	K22PBR-S	5062	0.85	-	-	VK22	6
3.0 V6 24V	147	UKZ (ZPJ4/Z)		07/90-06/94	K20PBR	5060	0.85	K20TT	IK20TT	IK20TT	6
XM (94-00)											
2.0 i 16V	97	RFV (XU10J4R)		07/95-10/00	K20TXR	5063	1.0	K20TT	IK20TT	IK20TT	4
2.0 Turbo	108	RGX (XU10J2TE); RGY (XU10J2TE/Z)		05/94-10/00	K20PR-U	3145	0.8	K20TT	IK20TT	IK20TT	4







	KW										QTY
CITROËN <i>continued</i>											
XM (94-00) <i>continued</i>											
2.1 D12	60	P9A (XUD11A)		07/94-06/96	DG-001		11V				4
2.1 TD 12V	80	P8A (XUD11ATE); P8C (XUD11BTE); PHZ (XUD11ATE); PJZ (XUD11ATE)		05/94-10/00	DG-001		11V				4
2.5 TD	95	THY (DK5ATE)		05/94-10/00	DG-001		11V				4
3.0 V6	123	UFZ (ZPJ/Z)		05/94-12/98	K20PBR	5060	0.85	K20TT	IK20TT	IK20TT	6
3.0 V6	140	XFZ (ES9J4)		04/97-10/00	K20TXR	5063	1.0	K20TT	IK20TT	IK20TT	6
3.0 V6 24V	147	UKZ (ZPJ4/Z)		05/94-04/97	K20PBR	5060	0.85	K20TT	IK20TT	IK20TT	6
XSARA (97-05)											
1.4 HDi	50	8HX (DV4TD)		01/03-08/05	DG-113		11V				4
1.4 i	55	KFX (TU3JP)		04/97-08/05	K20PR-U	3145	0.8	K20TT	IK20TT	IK20TT	4
1.4 i	55	KFX (TU3JP)		03/98-03/05	K20TXR	5063	1.0	K20TT	IK20TT	IK20TT	4
1.5 D	42	VJZ (TUD5)		04/97-09/00	DG-003		11V				4
1.6 16V	80	NFU (TU5JP4)		09/00-08/05	K16HPR-U11	6076	1.1	KH16TT	IKH16TT	IKH16TT	4
1.6 i	65	NFZ (TU5JP)		10/97-09/00	K16PR-U	3191	0.8	K16TT	IK16TT	IK16TT	4
1.8 D	43	161A (XUD7); A9A (XUD7)		04/97-09/00	DG-001		11V				4
1.8 i	66/74	LFX (XU7JB); LFZ (XU7JP)		02/98-09/00	K20TXR	5063	1.0	K20TT	IK20TT	IK20TT	4
1.8 i 16V	81	LFY (XU7JP4)		10/97-09/00	K20TXR	5063	1.0	K20TT	IK20TT	IK20TT	4
1.8 i Aut.	74	LFZ (XU7JP)		04/97-09/00	K20TXR	5063	1.0	K20TT	IK20TT	IK20TT	4
1.8 TD	66			10/97-09/00	DG-001		11V				4
1.9 D	50/55	DHV (XUD9BSD); DJY (XUD9A)		01/98-09/00	DG-001		11V				4
1.9 D	51	WJY (DW8B); WJZ (DW8)		07/98-08/05	DG-003		11V				4
1.9 SD	55	DHV (XUD9BSD)		01/98-09/00	DG-001		11V				4
1.9 TD	66	DHY (XUD9TE/Y)		10/97-09/00	DG-001		11V				4
2.0 16V	100	RFN (EW10J4)		09/00-08/05	K16HPR-U11	6076	1.1	KH16TT	IKH16TT	IKH16TT	4
2.0 16V	97	RFV (XU10J4R)		07/98-09/00	K20TXR	5063	1.0	K20TT	IK20TT	IK20TT	4
2.0 HDi	66	RHY (DW10TD)		04/01-03/05	DG-116		11V				4
2.0 HDi 109	80	RHZ (DW10ATED)		05/01-08/05	DG-116		11V				4
2.0 HDi 90	66	RHY (DW10TD)		02/99-08/05	DG-116		11V				4
2.0 i 16V	120	RFS (XU10J4RS)		02/98-08/00	K20TNR	3304	1.0	K20TT	IK20TT	IK20TT	4
XSARA Picasso (99-)											
1.6	65/ 67/ 70	NFV (TU5JP); NFZ (TU5JP)		12/99-	K16PR-U	3191	0.8	K16TT	IK16TT	IK16TT	4
1.6 16V	80/81	NFU (TU5JP4)		06/05-	K16HPR-U11	6076	1.1	KH16TT	IKH16TT	IKH16TT	4
1.6 Chrono	74			04/01-10/04	K16PR-U	3191	0.8	K16TT	IK16TT	IK16TT	4
1.6 HDi	66/80	9HX (DV6ATED4); 9HY (DV6TED4); 9HZ (DV6TED4)		05/04-	DG-113		11V				4
1.8 16V	85	6FZ (EW7J4)		02/00-12/05	K20HR-U11	3381	1.1	KH20TT	IKH20TT	IKH20TT	4
2.0 16V	100	RFN (EW10J4)		01/03-	K16HPR-U11	6076	1.1	KH16TT	IKH16TT	IKH16TT	4
2.0 HDi	66/80	RHY (DW10TD); RHZ (DW10ATED)		12/99-	DG-116		11V				4
ZX (91-98)											
1,1	40	H1B	Ch: Org Nr.4205>	03/91-08/93	Q20P-U	3125	0.8	Q20TT	IQ20TT	IQ20TT	4
1.1	44	HDZ (TU1M)		03/91-06/97	K20TXR	5063	1.0	K20TT	IK20TT	IK20TT	4
1.4	55	KDZ (TU3M/Z)		03/91-06/97	Q20PR-U	3007	0.8	Q20TT	IQ20TT	IQ20TT	4
1.4 i	55	KFX (TU3JP)		10/93-10/97	K20PR-U	3145	0.8	K20TT	IK20TT	IK20TT	4
1.4 i	55	KFX (TU3JP)		03/91-06/97	K20TXR	5063	1.0	K20TT	IK20TT	IK20TT	4
1.6	66			07/94-10/97	K20TXR	5063	1.0	K20TT	IK20TT	IK20TT	4
1.6 i	65	BDY (XU5M); BFZ (XU5JP)		03/91-10/97	Q20PR-U	3007	0.8	Q20TT	IQ20TT	IQ20TT	4
1.8	76	LFZ (XU7JP)		07/94-10/97	K20PR-U	3145	0.8	K20TT	IK20TT	IK20TT	4
1.8	82	LFY (XU7JP4)		04/96-10/97	K20TXR	5063	1.0	K20TT	IK20TT	IK20TT	4
1.8 D	44	161A (XUD7)		06/93-10/97	DG-001		11V				4
1.8 i	74	LFZ (XU7JP)		07/92-10/97	K20TXR	5063	1.0	K20TT	IK20TT	IK20TT	4
1.8 i 16V	81	LFY (XU7JP4)		01/96-02/98	K20TXR	5063	1.0	K20TT	IK20TT	IK20TT	4
1.9	93	D6E (XU9JA)		03/91-08/92	K20PR-U	3145	0.8	K20TT	IK20TT	IK20TT	4
1.9 D	47/50	D9B (XUD9A/U); DJY (XUD9A); DJZ (XUD9Y)		07/93-06/97	DG-001		11V				4
1.9 DT	65/68	XUD9TE(DHY)		06/92-10/97	DG-001		11V				4
1.9 i	88	DKZ (XU9JA)		03/91-06/94	Q20PR-U	3007	0.8	Q20TT	IQ20TT	IQ20TT	4
1.9 TD	66	DHY (XUD9TE/Y)		07/92-10/97	DG-001		11V				4
2.0	90	RFX (XU10J2C)		07/94-10/97	K20TXR	5063	1.0	K20TT	IK20TT	IK20TT	4

	KW								QTY		
CITROËN <i>continued</i>											
ZX (91-98) <i>continued</i>											
2.0 i	89	RFX (XU10J2C)		07/92-06/97	K20TXR	5063	1.0	K20TT	IK20TT	IK20TT	4
2.0 i 16V	112	RFY (XU10J4/Z)		07/92-10/94	K20PR-U	3145	0.8	K20TT	IK20TT	IK20TT	4
DACIA											
1210 (83-94)											
1.2	36			06/83-12/94	W20FPR-U	3070	0.7	WF20TT	-	-	4
1300 (72-83)											
1.3	40	810-02/-99		12/72-05/83	W20FPR-U	3070	0.7	WF20TT	-	-	4
1304 (83-04)											
1.3	40/41	810-02/-99		06/83-04/04	W20FPR-U	3070	0.7	WF20TT	-	-	4
1307 (84-94)											
1.4	48			06/84-11/94	W20FPR-U	3070	0.7	WF20TT	-	-	4
1309 (90-01)											
1.4	48			09/90-11/94	W20FPR-U	3070	0.7	WF20TT	-	-	4
1.6	53			12/94-08/01	W20FPR-U	3070	0.7	WF20TT	-	-	4
1310 (83-04)											
1.3	40	810-02/-99		05/83-07/04	W20FPR-U	3070	0.7	WF20TT	-	-	4
1.4	46/48			09/85-07/04	W20FPR-U	3070	0.7	WF20TT	-	-	4
1.4 Classic	46			01/95-07/04	W20FPR-U	3070	0.7	WF20TT	-	-	4
1410 (85-98)											
1.4	48			09/85-12/98	W20FPR-U	3070	0.7	WF20TT	-	-	4
DOKKER (12-)											
1.5 dCi	55/66	K9K 612		11/12-	DG-609		4.4V				4
DUSTER (10-)											
1.5 dCi	63	K9K 796; K9K 830		04/10-	DG-005		11V				4
1.5 dCi	66/79/80	K9K 856; K9K 884; K9K 892; K9K 896		10/10-	DG-609		4.4V				4
1.5 dCi 4x4	66/79/80/81	K9K 858; K9K 884; K9K 894; K9K 898		10/10-	DG-609		4.4V				4
1.6 16V	77	K4M 690; K4M 696		04/10-	K20PR-U	3145	0.8	K20TT	IK20TT	IK20TT	4
1.6 16V 4x4	77	K4M 606		06/10-	K20PR-U	3145	0.8	K20TT	IK20TT	IK20TT	4
1.6 16V Hi-Flex	77	K4M 696		08/10-	K20PR-U	3145	0.8	K20TT	IK20TT	IK20TT	4
1.6 16V LPG	77	K4M 696	LPG / GPL	04/11-	VK20	5604	1.1	-	IK20TT	IK20TT	4
LODGY (12-)											
1.5 dCi	66/79			03/12-	DG-609		4.4V				4
1.6	61	K7MA8		03/12-	K20PR-U	3145	0.8	K20TT	IK20TT	IK20TT	4
LOGAN I (04-)											
1.2 16V	55	D4F 732		02/06-	XE20HR-U9	3427	0.9	-	IXEH20TT	IXEH20TT	4
1.2 16V LPG	55			02/06-	XE20HR-U9	3427	0.9	-	IXEH20TT	IXEH20TT	4
1.4	55	K7J 710		01/09-	K20PR-U	3145	0.8	K20TT	IK20TT	IK20TT	4
1.4 (LSOA, LSOC, LSOE, LSOG)	55	K7J 710		09/04-	K20PR-U	3145	0.8	K20TT	IK20TT	IK20TT	4
1.4 MPI LPG (LS0C)	55	K7J 710; K7J 714	Flexible fuel	02/06-	K20TXR	5063	1.0	K20TT	IK20TT	IK20TT	4
1.5 dCi	55/65	K9K 892		05/10-	DG-609		4.4V				4
1.5 dCi (FS0K)	50	K9K 792		03/09-	DG-005		11V				4
1.5 dCi (FS0W)	63	K9K 796		03/09-	DG-005		11V				4
1.5 dCi (LS04)	55/65	K9K 892		05/10-	DG-609		4.4V				4
1.5 dCi (LS0J, LS0Y)	48	K9K 790		09/05-	DG-005		11V				4
1.5 dCi (LS0K)	50	K9K 792		01/06-	DG-005		11V				4
1.5 dCi (LS0W)	63	K9K 796		09/07-	DG-005		11V				4
1.5 dCi (US0K)	50	K9K 792		03/08-	DG-005		11V				4
1.5 dCi (US0W)	63	K9K 796		03/08-	DG-005		11V				4
1.6	64	K7M 710		03/08-	K20PR-U	3145	0.8	K20TT	IK20TT	IK20TT	4
1.6 (LSOB, LSOD, LSOF, LSOH)	64	K7M 710		09/04-	K20PR-U	3145	0.8	K20TT	IK20TT	IK20TT	4
1.6 16V (LS0M)	77	K4M 690; K4M 696		02/06-	K20PR-U	3145	0.8	K20TT	IK20TT	IK20TT	4
1.6 16V Flexifuel	77	K4M 696		07/10-	K20PR-U	3145	0.8	K20TT	IK20TT	IK20TT	4
1.6 Bifuel	62	K7M 718; K7M 800		05/10-	K20PR-U	3145	0.8	K20TT	IK20TT	IK20TT	4
1.6 MPI 85	62	K7M 800		05/10-	K20PR-U	3145	0.8	K20TT	IK20TT	IK20TT	4
1.6 MPI 85	62	K7M 800		05/10-	K20TXR	5063	1.0	K20TT	IK20TT	IK20TT	4
LOGAN II (12-)											
1.2	55			10/12-	XE20HR-U9	3427	0.9	-	IXEH20TT	IXEH20TT	4
1.2 LPG	55	D4F 734		10/12-	XE20HR-U9	3427	0.9	-	IXEH20TT	IXEH20TT	4
1.5 dCi	55/66	K9K 612		10/12-	DG-609		4.4V				4
LOGAN MCV I (07-)											
1.4	55	K7J 710		02/07-	K20PR-U	3145	0.8	K20TT	IK20TT	IK20TT	4
1.5 dCi (KS04)	55/65	K9K 892		05/10-	DG-609		4.4V				4
1.5 dCi (KS0K)	50	K9K 792		02/07-	DG-005		11V				4







	KW										QTY
DACIA <i>continued</i>											
LOGAN MCV I (07-) <i>continued</i>											
1.5 dCi (KS0W)	63	K9K 796		09/07-	DG-005		11V				4
1.6	64	K7M 710		02/07-	K20PR-U	3145	0.8	K20TT	IK20TT	IK20TT	4
1.6 16V	77	K4M 690; K4M 696		02/07-	K20PR-U	3145	0.8	K20TT	IK20TT	IK20TT	4
1.6 16V Hi-Flex	77	K4M 690; K4M 694	Flexible fuel	11/09-	K20PR-U	3145	0.8	K20TT	IK20TT	IK20TT	4
1.6 Bifuel	64	K7M 710	Flexible fuel	11/08-	K20TXR	5063	1.0	K20TT	IK20TT	IK20TT	4
1.6 MPI 85	62	K7M 800		05/10-	K20TXR	5063	1.0	K20TT	IK20TT	IK20TT	4
LOGAN MCV II (13-)											
1.2	55			02/13-	XE20HR-U9	3427	0.9	-	IXEH20TT	IXEH20TT	4
1.2 LPG	55			02/13-	XE20HR-U9	3427	0.9	-	IXEH20TT	IXEH20TT	4
1.5 dCi	55/66	K9K 612		02/13-	DG-609		4.4V				4
NOVA (96-03)											
1.4	48	C2J		04/96-03/01	W16EPR-U	3021	0.8	W16TT	IW16TT	IW16TT	4
1.6	53			04/96-08/98	W20EPR-U	3047	0.8	W20TT	IW20TT	IW20TT	4
PICK UP (89-00)											
1.4	48			09/89-09/00	W20FPR-U	3070	0.7	WF20TT	-	-	4
SANDERO I (08-)											
1.2 16V	55	D4F 732		11/08-	XE20HR-U9	3427	0.9	-	IXEH20TT	IXEH20TT	4
1.2 16V LPG	55	D4F 732		11/08-	XE20HR-U9	3427	0.9	-	IXEH20TT	IXEH20TT	4
1.4	55	K7J 710		06/08-	K20TXR	5063	1.0	K20TT	IK20TT	IK20TT	4
1.4 MPI LPG	53	K7J 714	Flexible fuel	01/09-	K20TXR	5063	1.0	K20TT	IK20TT	IK20TT	4
1.5 dCi	50/63	K9K 792; K9K 796		11/08-	DG-005		11V				4
1.5 dCi	55/65	K9K 892		05/10-	DG-609		4.4V				4
1.6	64	K7M 710		06/08-	K20TXR	5063	1.0	K20TT	IK20TT	IK20TT	4
1.6 16V Bifuel	77	K4M 690; K4M 694; K4M 696		01/11-	K20PR-U	3145	0.8	K20TT	IK20TT	IK20TT	4
1.6 MPI 85	62	K7M 800		05/10-	K20TXR	5063	1.0	K20TT	IK20TT	IK20TT	4
SANDERO II (12-)											
1.2	55	D4F 732		10/12-	XE20HR-U9	3427	0.9	-	IXEH20TT	IXEH20TT	4
1.2 LPG	55			10/12-	XE20HR-U9	3427	0.9	-	IXEH20TT	IXEH20TT	4
1.5 dCi	55/66	K9K 612		10/12-	DG-609		4.4V				4
SOLENZA (03-)											
1.4	55	K7J 710		02/03-	K20PR-U	3145	0.8	K20TT	IK20TT	IK20TT	4
1.9 D	46	F8Q.630		02/03-	DG-008		11V				4
SUPERNOVA (00-03)											
1.4	55			04/00-03/03	K20PR-U	3145	0.8	K20TT	IK20TT	IK20TT	4
DAEWOO											
CIELO (94-98)											
1.5	66	V15L		06/94-07/98	K20PR-U11	3121	1.1	K20TT	IK20TT	IK20TT	4
1.5	55	Y15L		04/95-07/97	W20EPR-U	3047	0.8	W20TT	IW20TT	IW20TT	4
ESPERO (91-99)											
1.5	55	G15MF		10/97-09/99	K20PR-U11	3121	1.1	K20TT	IK20TT	IK20TT	4
1.5 16V	65/66	A15MF		10/93-06/99	K20PR-U11	3121	1.1	K20TT	IK20TT	IK20TT	4
1.8	66/70	C18LE		02/95-09/99	W20EPR-U	3047	0.8	W20TT	IW20TT	IW20TT	4
2.0	74/ 77/ 81	C20LE; C20LZ		10/91-09/94	W20EPR-U	3047	0.8	W20TT	IW20TT	IW20TT	4
EVANDA (02-)											
2.0	96	C20SED		08/02-05/05	K20TXR	5063	1.0	K20TT	IK20TT	IK20TT	4
GENTRA (02-05)											
1.2 SE	53	B12S1		11/02-04/05	W16EPR-U	3021	0.8	W16TT	IW16TT	IW16TT	4
1.4 SR	69	F14D3		05/03-04/05	K20PR-U11	3121	1.1	K20TT	IK20TT	IK20TT	4
1.5 SE	62	A15SMS		11/02-04/05	W20EPR-U	3047	0.8	W20TT	IW20TT	IW20TT	4
GENTRA (05-)											
1.4	69	F14D3		05/05-	K20PR-U11	3121	1.1	K20TT	IK20TT	IK20TT	4
1.6 E-Tec LS	77	F16D3		05/05-	K20PR-U11	3121	1.1	K20TT	IK20TT	IK20TT	4
GENTRA (13-)											
1.5	79			06/13-	XU22EPR-U	3179	0.9	XU22TT	-	VXU22	4
KALOS (02-)											
1.2	53	B12S1; F12S3		04/03-	W16EPR-U	3021	0.8	W16TT	IW16TT	IW16TT	4
1.4	69	F14D3		05/03-12/04	K20PR-U11	3121	1.1	K20TT	IK20TT	IK20TT	4
1.4	61	F14S3		09/02-	W20EPR-U	3047	0.8	W20TT	IW20TT	IW20TT	4
1.4 16V	69	F14D3		04/03-	K20PR-U11	3121	1.1	K20TT	IK20TT	IK20TT	4
KORANDO (99-)											
2.3	105	M111E23		01/99-07/05	Q16PR-U11	5016	1.1	Q16TT	IQ16TT	IQ16TT	4
2.9 D	72	MB-OM 662		01/99-	DG-010		11.5V				5
2.9 TD	88	MB-OM 601 29TD		01/99-	DG-010		11.5V				5
3.2 4x4	156	M104E32		01/99-07/05	Q16PR-U11	5016	1.1	Q16TT	IQ16TT	IQ16TT	6

Spark & Glow Plugs

Application Tables

	KW					Standard		Twin Tip		QTY	
DAEWOO <i>continued</i>											
LACETTI (97-99)											
1.5 SE	81	A15DMS		04/98-05/99	K20PR-U11	3121	1.1	K20TT	IK20TT	IK20TT	4
1.5 SX	63	A15SMS		04/97-05/99	W20EPR-U	3047	0.8	W20TT	IW20TT	IW20TT	4
LACETTI (04-)											
1.4	70	F14D3		02/04-	K20TXR	5063	1.0	K20TT	IK20TT	IK20TT	4
1.6	80	F16D3		02/04-	K20TXR	5063	1.0	K20TT	IK20TT	IK20TT	4
1.8	90	T18SED		02/04-	K20TXR	5063	1.0	K20TT	IK20TT	IK20TT	4
LANOS (97-)											
1.4	55	A13SMS		05/97-07/05	W20EPR-U	3047	0.8	W20TT	IW20TT	IW20TT	4
1.5	63/73	A15SMS		05/97-07/05	W20EPR-U	3047	0.8	W20TT	IW20TT	IW20TT	4
1.6 16V	78	A16DMS		05/97-07/05	K20PR-U11	3121	1.1	K20TT	IK20TT	IK20TT	4
LEGANZA (97-04)											
2.0 16V	93/98	X20SED(127); X20SED(133)		06/97-01/03	K20TXR	5063	1.0	K20TT	IK20TT	IK20TT	4
2.2 16V	100	X22SED		04/99-12/02	K20TXR	5063	1.0	K20TT	IK20TT	IK20TT	4
MATIZ (98-)											
0.8	38	F8CV		09/98-	W16EXR-U11	3032	1.1	W16TT	IW16TT	IW16TT	3
1.0	47	B10S		01/03-02/05	W16EPR-U	3021	0.8	W16TT	IW16TT	IW16TT	4
MUSSO (99-)											
2.2 TD	74	MB OM 601		09/99-	DG-010		11.5V				4
2.3	103	M161E23		01/99-07/05	Q16PR-U11	5016	1.1	Q16TT	IQ16TT	IQ16TT	4
2.9 D 4x4	73	MB-OM 662		01/99-09/99	DG-010		11.5V				5
2.9 TD 4x4	88	MB-OM 601 29TD		01/99-	DG-010		11.5V				5
3.2 4x4	162	M 104.992		01/99-	Q20PR-U	3007	0.8	Q20TT	IQ20TT	IQ20TT	6
NEXIA (95-08)											
1.5	44/ 52/ 55	G15MF		02/95-08/97	W20EPR-U	3047	0.8	W20TT	IW20TT	IW20TT	4
1.5 16V	66	A15MF		02/95-08/97	K20PR-U11	3121	1.1	K20TT	IK20TT	IK20TT	4
NEXIA (08-)											
1.5	59	Y15L		07/08-	W20EPR-U	3047	0.8	W20TT	IW20TT	IW20TT	4
1.6	80	F16D3		07/08-	K20PR-U11	3121	1.1	K20TT	IK20TT	IK20TT	4
NUBIRA (97-)											
1.5 SE	81	A15DMS		06/99-07/03	K20PR-U11	3121	1.1	K20TT	IK20TT	IK20TT	4
1.6	76	A16DMS		08/02-07/03	K20PR-U11	3121	1.1	K20TT	IK20TT	IK20TT	4
1.6 16V	66/ 76/ 78	A16DMS; A16SMS		05/97-	K20PR-U11	3121	1.1	K20TT	IK20TT	IK20TT	4
2.0 16V	93/98	DTEC20(133);X20NE D; DTEC20(133); X20S; X20S, X20SED(133); X20SED(127); X20SED(133)		05/97-09/04	K20TXR	5063	1.0	K20TT	IK20TT	IK20TT	4
NUBIRA (03-)											
1.6	80	F16D3		07/03-	K20PR-U11	3121	1.1	K20TT	IK20TT	IK20TT	4
1.8	90	T18SED		07/03-07/05	K20TXR	5063	1.0	K20TT	IK20TT	IK20TT	4
REXTON (02-)											
2.9 TD	88	OM 662.983		04/02-	DG-010		11.5V				5
3.2 V6	162	M162E32		04/02-07/05	Q16PR-U11	5016	1.1	Q16TT	IQ16TT	IQ16TT	6
TACUMA / REZZO (00-)											
1.6	77	A16DMS		09/00-	K20PR-U11	3121	1.1	K20TT	IK20TT	IK20TT	4
1.8	66/ 72/ 74	F18S2(100); F18S2(90)		09/00-07/05	W20EPR-U	3047	0.8	W20TT	IW20TT	IW20TT	4
2.0	89/94	X 20 SED; X20SED(127)		09/00-07/05	K20TXR	5063	1.0	K20TT	IK20TT	IK20TT	4
TICO (95-00)											
0.8	35	H800		02/95-12/00	W16EPR-U	3021	0.8	W16TT	IW16TT	IW16TT	3
0.8	38	F8CV		01/96-12/00	W16EPR-U11	3201	1.1	W16TT	IW16TT	IW16TT	3
DAF											
55 (67-72)											
1.1	33	110E		05/68-09/72	W16FPR-U	4192	0.7	-	-	-	4
1.1 MARATHON	40	110E		12/71-09/72	W16FPR-U	4192	0.7	-	-	-	4
66 (72-75)											
1.1	35	110E		10/72-08/75	W16FPR-U	4192	0.7	-	-	-	4
1.1 MARATHON	40	110G		10/72-08/75	W16FPR-U	4192	0.7	-	-	-	4
1.1 SL	40	110G		10/72-08/75	W16FPR-U	4192	0.7	-	-	-	4
1300 MARATHON	42	B13;0S		09/73-08/75	W20FPR-U	3070	0.7	WF20TT	-	-	4
400-Serie (89-93)											
428-435 2.5 D	53	BN 52; EN 55		04/89-08/93	DG-001		11V				4

KW	KW	KW	KW	KW	KW	Standard			Twin Tip			QTY
						Standard	Standard	Standard	Twin Tip	Twin Tip	Twin Tip	
DAF <i>continued</i>												
400-Serie (89-93) <i>continued</i>												
428-435 2.5 TD	71	ET 70		04/89-08/93	DG-001		11V					4
DAIHATSU												
ALTIS (96-01)												
2.2 4x4	103	5S-FE		10/96-07/01	PK20TR11	3253	1.1		K20TT	IK20TT	IK20TT	4
2.2 SL	103	5S-FE		10/96-07/01	PK20TR11	3253	1.1		K20TT	IK20TT	IK20TT	4
2.2 SL 4x4	103	5S-FE		10/96-07/01	PK20TR11	3253	1.1		K20TT	IK20TT	IK20TT	4
ALTIS (06-)												
2.4 VVTi SX	116	2AZ-FE		01/06-	SK20R11	3297	1.1	-		IK20TT	IK20TT	4
2.4 VVTi SX 4x4	116	2AZ-FE		01/06-	SK20R11	3297	1.1	-		IK20TT	IK20TT	4
APPLAUSE I (89-97)												
1.6 16V (A101)	66	HD		06/89-06/92	K20PR-U11	3121	1.1		K20TT	IK20TT	IK20TT	4
1.6 16V (A101)	77	HD-E		06/89-07/97	K20TNR-S	3196	1.0		K20TT	IK20TT	IK20TT	4
1.6 16V 4WD (A111)	77	HD-E		06/89-07/97	K20TNR-S	3196	1.0		K20TT	IK20TT	IK20TT	4
APPLAUSE II (97-00)												
1.6 16V (A101)	73	HD-E		07/97-05/00	K20TNR-S	3196	1.0		K20TT	IK20TT	IK20TT	4
BEGO (05-)												
1.5 DVVT 4x4	77	3SZ-VE		11/05-	SXU22PR9	3434	0.9	-	-		VXU22I	4
BOON (06-)												
1.0	51	1KR-FE		01/10-	SK20HR11	3421	1.1	-		IKH20TT	IKH20TT	3
CHARADE I (77-83)												
1.0	37/38	CB 20; CB 22		10/77-02/83	W16EXR-U	3031	0.8		W16TT	IW16TT	IW16TT	3
CHARADE II (83-87)												
1.0 (G11)	38	CB 22		10/83-03/87	W16EXR-U	3031	0.8		W16TT	IW16TT	IW16TT	3
1.0 D (G30)	27	CL 10		10/83-03/87	DG-223		7V					3
1.0 TD (G30)	34	CL 60		02/85-03/87	DG-223		7V					3
1.0 Turbo (G11)	50	CB 60		10/83-03/87	W20EXR-U	3066	0.8		W20TT	IW20TT	IW20TT	3
CHARADE III (87-93)												
1.0 (G100)	38	CB 23		03/87-12/92	W16EXR-U	3031	0.8		W16TT	IW16TT	IW16TT	3
1.0 (G100)	40/41	CB 90		04/89-12/92	W16EXR-U11	3032	1.1		W16TT	IW16TT	IW16TT	3
1.0 D (G101)	27	CL 11		03/87-12/92	DG-216		11V					3
1.0 GTi (G100)	74	CB 80 T		03/87-12/92	W20ETR-L	3277	1.0	-		IW20TT	IW20TT	3
1.0 TD (G101)	35	CL; CL 61		03/87-12/92	DG-216		11V					3
1.0 Turbo (G100)	50	CB 61		03/87-10/90	W20EXR-U	3066	0.8		W20TT	IW20TT	IW20TT	3
1.3	66	HCE		11/90-02/93	K20PR-U11	3121	1.1		K20TT	IK20TT	IK20TT	4
1.3 i (G102)	66	HCE		06/88-12/92	K20TNR-S	3196	1.0		K20TT	IK20TT	IK20TT	4
1.3 i 4WD (G102)	66	HCE		06/88-01/93	K20TNR-S	3196	1.0		K20TT	IK20TT	IK20TT	4
CHARADE IV (93-00)												
1.0	38	CB 22		09/94-03/96	W16EXR-U	3031	0.8		W16TT	IW16TT	IW16TT	3
1.3	44	HC		09/96-11/99	K20TNR-S	3196	1.0		K20TT	IK20TT	IK20TT	4
1.3 16V	55	HCE		05/96-11/99	K20PR-U11	3121	1.1		K20TT	IK20TT	IK20TT	4
1.3 i 16V	62	HC		01/93-09/00	K20TNR-S	3196	1.0		K20TT	IK20TT	IK20TT	4
1.5 16V	55	HEE		10/94-	K20PR-U11	3121	1.1		K20TT	IK20TT	IK20TT	4
1.5 HG	55	HEE		06/94-03/96	K20PR-U11	3121	1.1		K20TT	IK20TT	IK20TT	4
1.5 i 16V	66	HEE		08/94-	K20PR-U11	3121	1.1		K20TT	IK20TT	IK20TT	4
1.6 GTi	77	HD-E		03/93-11/99	K20TNR-S	3196	1.0		K20TT	IK20TT	IK20TT	4
CHARADE V (03-)												
1.0 (L251S)	43	EJ-VE		03/03-	K16TNR-S9	3329	0.9		K16TT	IK16TT	IK16TT	3
CHARADE VI (11-)												
1.33 16V	73	1NRFE		05/11-	SC20HR11	3444	1.1	-		IXEH22TT	IXEH22TT	4
CHARMANT (81-87)												
1.3 (A35)	48	4K		11/81-07/87	W16EXR-U	3031	0.8		W16TT	IW16TT	IW16TT	4
1.6 (A45)	55	2T		12/81-08/83	W16EXR-U	3031	0.8		W16TT	IW16TT	IW16TT	4
1.6 (A60)	57/ 60/ 61	4A		08/83-07/87	W16EXR-U	3031	0.8		W16TT	IW16TT	IW16TT	4
COPEN (03-)												
0.7	47	JB-DET		09/03-08/10	VK20Y	5620	0.8	-	-		VK20Y	4
0.7 (L880)	50	JB; JB-DET		09/03-08/10	VK20Y	5620	0.8	-	-		VK20Y	4
1.3	64	K3-VE		03/06-	K20R-U11	3139	1.1		K20TT	IK20TT	IK20TT	4
CUORE I (80-85)												
0.5 (L55)	20	AB 30		10/80-09/85	W20EXR-U	3066	0.8		W20TT	IW20TT	IW20TT	2
0.6 (L60)	22	AD 10		08/82-09/85	W20EXR-U	3066	0.8		W20TT	IW20TT	IW20TT	2
CUORE II (85-90)												
0.8 (L80)	29/32	ED 10		09/85-12/90	W20EXR-U	3066	0.8		W20TT	IW20TT	IW20TT	3
0.8 4WD (L81)	32	ED 10		09/86-10/88	W20EXR-U	3066	0.8		W20TT	IW20TT	IW20TT	3
CUORE III (90-94)												
0.8	30	ED 10 K		10/90-12/94	W20EXR-U	3066	0.8		W20TT	IW20TT	IW20TT	3

	KW					Standard		Twin Tip		QTY	
DAIHATSU <i>continued</i>											
CUORE IV (94-99)											
0.8	32	ED 20		01/95-11/96	W16EXR-U11	3032	1.1	W16TT	IW16TT	IW16TT	3
CUORE V (96-98)											
0.8	31	EF-EL		11/96-10/98	W20EXR-U	3066	0.8	W20TT	IW20TT	IW20TT	3
CUORE VI (98-03)											
1.0 i (L701)	41	EJDE		10/98-05/03	K16PR-U11	3130	1.1	K16TT	IK16TT	IK16TT	3
CUORE VII (03-)											
1.0	43	EJ-VE		05/03-08/07	K16TNR-S9	3329	0.9	K16TT	IK16TT	IK16TT	3
CUORE VIII (07-)											
1.0	51	1KR-FE		04/07-	SK20HR11	3421	1.1	-	IKH20TT	IKH20TT	3
DELTA (84-87)											
3.0 D	53			09/84-08/87	DG-222		14V				4
DELTA Wide (84-99)											
2.2 TD	74			10/92-11/96	DG-305		11V				4
2.8 D	54			09/87-05/95	DG-223		7V				4
3.0 D	53			09/84-08/87	DG-222		14V				4
ESSE (05-)											
0.7	43	KF-VE		03/05-	XU20HR9		0.9	-	-		3
0.7 4x4	43	KF-VE		03/05-	XU20HR9		0.9	-	-		3
EXTOL (00-)											
1.3	63	K3-VE		07/00-11/04	W20EXR-U	3066	0.8	W20TT	IW20TT	IW20TT	4
FEROZA (88-99)											
1.6 16V	63	HD-C		10/88-12/97	K20PR-U11	3121	1.1	K20TT	IK20TT	IK20TT	4
1.6 i 16V	70	HD-E(95)		10/88-12/97	K20PR-U11	3121	1.1	K20TT	IK20TT	IK20TT	4
1.6 i 16V 4x4	70	HD-E(95)		10/88-12/97	K20PR-U11	3121	1.1	K20TT	IK20TT	IK20TT	4
GRAN MOVE (96-)											
1.5 16V (G303)	66	HEE		10/96-07/98	K20PR-U11	3121	1.1	K20TT	IK20TT	IK20TT	4
1.6 16V (G301)	67	HD-EP		05/98-07/02	K20PR-U11	3121	1.1	K20TT	IK20TT	IK20TT	4
HIJET (86-90)											
0.8	29	CD		06/86-10/90	W16EXR-U	3031	0.8	W16TT	IW16TT	IW16TT	3
1.0	33	CB		06/86-12/89	W16EXR-U	3031	0.8	W16TT	IW16TT	IW16TT	3
1.0 4x4	33	CB		07/86-10/90	W16EXR-U	3031	0.8	W16TT	IW16TT	IW16TT	3
HIJET (92-)											
1.0	33	CB41		12/92-05/98	W16EXR-U	3031	0.8	W16TT	IW16TT	IW16TT	3
1.0 i	35	CB42		07/94-05/98	W16EXR-U11	3032	1.1	W16TT	IW16TT	IW16TT	3
1.2 D	26/27	LDW12		05/95-03/98	DG-001		11V				4
1.3 i 16V	48	HCE		05/98-	K20TNR-S	3196	1.0	K20TT	IK20TT	IK20TT	4
HIJET (98-)											
1.3	48/ 52/ 55	HCE		06/98-	K20PR-U11	3121	1.1	K20TT	IK20TT	IK20TT	4
MATERIA (06-)											
1.3	67	K3-VE(92)		10/06-	SXU22PR9	3434	0.9	-	-	VXU22I	4
1.5	76	3SZ-VE		10/06-	SXU22PR9	3434	0.9	-	-	VXU22I	4
1.5 ECO 4WD	76	3SZ-VE		10/06-	SXU22PR9	3434	0.9	-	-	VXU22I	4
MIRA GINO (06-)											
0.7	43	EF-VE		10/06-12/08	IK20	5304	1.1	-	IK20TT	IK20TT	3
0.7	43	KF-VE		10/06-	XU20HR9		0.9	-	-		3
MOVE (94-)											
0.8	31	ED 20		10/96-	W16EXR-U11	3032	1.1	W16TT	IW16TT	IW16TT	3
1.0 i	41	EJDE		10/98-	K16PR-U11	3130	1.1	K16TT	IK16TT	IK16TT	3
MOVE (02-)											
0.7	43	EF-VE		10/02-	K20TNR-S9	3305	0.9	K20TT	IK20TT	IK20TT	3
0.7 Turbo	47	JB-DET		10/03-09/06	SK20PR-A8	3403	0.8	-	IK20TT	IK20TT	4
0.7 Turbo	47	JB-DET		10/02-09/03	VK20Y	5620	0.8	-	-	VK20Y	4
ROCKY (85-98)											
2.0	65	3Y		02/85-08/91	W16EXR-U	3031	0.8	W16TT	IW16TT	IW16TT	4
2.0 4x4	65	3Y		02/85-08/91	W16EXR-U	3031	0.8	W16TT	IW16TT	IW16TT	4
2.8 D	54	DL		02/85-12/98	DG-223		7V				4
2.8 TD	67/ 72/ 75	DL 51; DL 52; DLT-C		12/87-12/98	DG-223		7V				4
RUGGER (84-93)											
2.8 D 4x4	54	DL		04/84-04/93	DG-223		7V				4
2.8 TDIC 4x4	67	DLT		04/84-04/93	DG-223		7V				4
SIRION (98-05)											
1.0	40	EJ-DE		04/98-10/00	K16PR-U11	3130	1.1	K16TT	IK16TT	IK16TT	3
1.0 i	43	EJ-VE		09/00-01/05	K16TNR-S9	3329	0.9	K16TT	IK16TT	IK16TT	3
1.0 i (M100)	41	EJ-DE		04/98-09/00	K16PR-U11	3130	1.1	K16TT	IK16TT	IK16TT	3











Spark & Glow Plugs

Application Tables

KW	KW	KW	KW	KW	KW	Standard			Twin Tip			QTY
						Standard	Standard	Standard	Twin Tip	Twin Tip	Twin Tip	
DAIHATSU <i>continued</i>												
SIRION (98-05) <i>continued</i>												
1.0 i 4WD	41	EJ-DE		04/99-09/00	K16PR-U11	3130	1.1	K16TT	IK16TT	IK16TT	3	
1.0 i 4WD	43	EJ-VE		09/00-01/05	K16TNR-S9	3329	0.9	K16TT	IK16TT	IK16TT	3	
1.3 Sport	75	K3-VE/102e2		08/00-01/05	K20BR-S10	3330	1.0	K20TT	IK20TT	IK20TT	4	
1.3 Sport 4WD	75	K3-VE2		08/00-03/05	K20PBR-S10	5061	1.0	K20TT	IK20TT	IK20TT	4	
SIRION (05-)												
1.0	51	1KR-FE		01/05-	SK20HR11	3421	1.1	-	IKH20TT	IKH20TT	3	
1.0 DVVT 4WD	51	1KR-FE		04/05-	SK20HR11	3421	1.1	-	IKH20TT	IKH20TT	3	
1.3	64	K3-VE		01/05-06/07	K20R-U11	3139	1.1	K20TT	IK20TT	IK20TT	4	
1.3	67	K3-VE		03/08-	XU22PR9	3448	0.9	XU22TT	-	VXU22I	4	
1.3 4WD	64	K3-VE		04/05-	K20R-U11	3139	1.1	K20TT	IK20TT	IK20TT	4	
1.3 4WD	67	K3-VE		03/08-	XU22PR9	3448	0.9	XU22TT	-	VXU22I	4	
1.5	76	3SZ-VE		03/08-	XU22PR9	3448	0.9	XU22TT	-	VXU22I	4	
1.5 4WD	76	3SZ-VE		05/06-10/08	XU22PR9	3448	0.9	XU22TT	-	VXU22I	4	
TAFT (76-85)												
2.5 D 4x4 (F50, F55)	45	DG		08/78-08/82	DG-234		8.5V				4	
2.8 D 4x4 (F60, F65)	51	DL		08/82-04/84	DG-223		7V				4	
TANTO (02-)												
0.7	43	KF-VE		09/02-	XU20HR9		0.9	-	-		3	
TERIOS (97-)												
0.7	44			09/00-	K20TNR-S9	3305	0.9	K20TT	IK20TT	IK20TT	3	
0.7	47	EF-DET		09/00-	VK20Y	5620	0.8	-	-	VK20Y	3	
0.7 4WD	44			05/97-08/00	K20TNR-S9	3305	0.9	K20TT	IK20TT	IK20TT	3	
0.7 4WD	47	EF-DET		05/97-08/00	VK20Y	5620	0.8	-	-	VK20Y	3	
1.3	63	K3-VE		09/01-10/05	K20PBR-S10	5061	1.0	K20TT	IK20TT	IK20TT	4	
1.3 4WD	63	K3-VE		10/00-10/05	K20PBR-S10	5061	1.0	K20TT	IK20TT	IK20TT	4	
1.3 4WD	61	HC-EJ		10/97-10/00	K20TNR-S	3196	1.0	K20TT	IK20TT	IK20TT	4	
1.3 DVVT Turbo 4WD	103			10/02-10/05	VK20Y	5620	0.8	-	-	VK20Y	4	
TERIOS (05-)												
1.3 DVVT	63	K3-VE		11/05-	K20PBR-S10	5061	1.0	K20TT	IK20TT	IK20TT	4	
1.3 VVT-i 4x4	63	K3-VE		11/05-	K20PBR-S10	5061	1.0	K20TT	IK20TT	IK20TT	4	
1.5 4x4	77	3SZ-VE		05/06-	SXU22PR9	3434	0.9	-	-	VXU22I	4	
1.5 VVT-i	75/77	3SZ-VE		11/05-	SXU22PR9	3434	0.9	-	-	VXU22I	4	
1.5 VVT-i [RWD]	77	3SZ-VE		11/05-	SXU22PR9	3434	0.9	-	-	VXU22I	4	
1.5 VVT-i 4x4	75			09/10-	SXU22PR9	3434	0.9	-	-	VXU22I	4	
TREVIS (06-)												
1.0	43	EJ-VE/E4		06/06-	K16TNR-S9	3329	0.9	K16TT	IK16TT	IK16TT	3	
WILDCAT / ROCKY (85-87)												
2.8 D	54	DL		02/85-03/87	DG-223		7V				4	
2.8 TD	65	DL 50		09/85-04/87	DG-223		7V				4	
YRV (01-)												
1.0	43	EJ-VE		02/01-01/07	K16TNR-S9	3329	0.9	K16TT	IK16TT	IK16TT	3	
1.3	64	K3-VE		02/01-07/05	K20PBR-S10	5061	1.0	K20TT	IK20TT	IK20TT	4	
1.3 4WD	64	K3-VE		02/01-07/05	K20BR-S10	3330	1.0	K20TT	IK20TT	IK20TT	4	
1.3 GTi	95	K3-VET		07/02-07/05	VK20Y	5620	0.8	-	-	VK20Y	4	
DAIMLER												
2.8 - 5.3 (69-93)												
3.6	156			10/86-09/89	W16EPR-U	3021	0.8	W16TT	IW16TT	IW16TT	6	
Double Six / Vanden 5.3	186/198			07/72-05/75	W16EPR-U	3021	0.8	W16TT	IW16TT	IW16TT	12	
Double Six 5.3	194/197	7P; V 12 (90-93)		07/81-02/93	T22EP-U	5040	0.8	-	-	-	12	
Double Six 5.3	211	V 12 (75-79)		05/75-07/81	W16EPR-U	3021	0.8	W16TT	IW16TT	IW16TT	12	
Double Six H.E. 5.3	217	V 12 (82-90)		07/81-10/86	T22EP-U	5040	0.8	-	-	-	12	
Sovereign 2.8	110			10/69-05/75	W16EPR-U	3021	0.8	W16TT	IW16TT	IW16TT	6	
Sovereign 3.4	120	XK		05/75-12/78	W16EPR-U	3021	0.8	W16TT	IW16TT	IW16TT	6	
Sovereign 4.2	124/127/137/151	XK 4.2 (-79); XK 4.2 (82-87)		06/76-10/86	W16EPR-U	3021	0.8	W16TT	IW16TT	IW16TT	6	
COUPE (73-77)												
Double Six 5.3	213			05/75-12/77	W16EPR-U	3021	0.8	W16TT	IW16TT	IW16TT	12	
Sovereign 4.2	127			09/73-12/77	W16EPR-U	3021	0.8	W16TT	IW16TT	IW16TT	6	
DAIMLER XJ (94-03)												
Double Six 6.0	229	8E		10/94-06/03	T22EP-U	5040	0.8	-	-	-	12	
LANDAULETTE (74-91)												
4.2	123/131			03/74-12/91	W16EPR-U	3021	0.8	W16TT	IW16TT	IW16TT	6	
LIMOUSINE (68-91)												
4.2	123/131			06/68-12/91	W16EPR-U	3021	0.8	W16TT	IW16TT	IW16TT	6	





Spark & Glow Plugs

Application Tables

	KW										QTY
DALLAS											
FUN (94-)											
1.8 D	43			01/94-	DG-001		11V				4
DE LOREAN											
DMC-12 (81-83)											
2.9	97	PRV28		01/81-12/83	IT20	5326	1.1	-	IT20TT	IT20TT	6
DODGE											
AVENGER (07-)											
2.0	115	ECN		06/07-11/10	KJ16CR-U11	3311	1.1	K16TT	IK16TT	IK16TT	4
2.0 CRD	103	ECD		06/07-11/10	DG-190		4.4V				4
2.4	129	ED3		06/07-11/10	KJ16CR-U11	3311	1.1	K16TT	IK16TT	IK16TT	4
2.7	137	EER		06/07-11/10	ITL20	5350	1.1	-	-	-	6
2.7 Flex-Fuel	139	EER		06/07-11/10	ITL20	5350	1.1	-	-	-	6
CALIBER (06-)											
1.8	110	EBA		06/06-05/11	IK16	5303	1.1	-	IK16TT	IK16TT	4
2.0	115	ECN		06/06-05/11	IK16	5303	1.1	-	IK16TT	IK16TT	4
2.0 CRD	103	ECD		09/06-05/11	DG-190		4.4V				4
2.4	125/126	ED3		10/06-05/11	KJ16CR-U11	3311	1.1	K16TT	IK16TT	IK16TT	4
2.4 AWD	125	ED3		10/06-05/11	KJ16CR-U11	3311	1.1	K16TT	IK16TT	IK16TT	4
2.4 SRT4 AWD	223	ED4		10/06-	IK20L	5358	1.1	-	IK20TT	IK20TT	4
2.4 Turbo	217	ED4		12/07-	IK20L	5358	1.1	-	IK20TT	IK20TT	4
CARAVAN (89-90)											
3.3	112	EGA		10/89-09/90	W16EXR-U13	3213	1.3	W16TT	IW16TT	IW16TT	6
CARAVAN (95-02)											
2.0 i	98			01/95-03/01	K20PR-U	3145	0.8	K20TT	IK20TT	IK20TT	4
2.4 i	111	EDZ		01/95-03/01	K16R-U11	3120	1.1	K16TT	IK16TT	IK16TT	4
2.5 TD	85	ENC		01/95-04/95	DG-001		11V				4
2.5 TD	85	ENC		05/95-10/02	DG-109		11V				4
3.0	112	EFA		01/95-03/01	W16EPR-U	3021	0.8	W16TT	IW16TT	IW16TT	6
3.3 i	116	EGP		10/96-03/01	P16R13	3239	1.3	W20TT	IW20TT	IW20TT	6
3.3 i	116	EGP		01/95-09/96	W16EXR-U13	3213	1.3	W16TT	IW16TT	IW16TT	6
3.8 i	122/131	EGH		10/96-03/01	P16R13	3239	1.3	W20TT	IW20TT	IW20TT	6
3.8 i	122/131	EGH		01/95-09/96	W16EXR-U13	3213	1.3	W16TT	IW16TT	IW16TT	6
3.8 i AWD	122/131	EGH		10/96-03/01	P16R13	3239	1.3	W20TT	IW20TT	IW20TT	6
3.8 i AWD	122/131	EGH		01/95-09/96	W16EXR-U13	3213	1.3	W16TT	IW16TT	IW16TT	6
CARAVAN (00-07)											
2.4	111	EDZ		02/00-12/07	ITL16	5349	1.1	-	ITL16TT	ITL16TT	4
3.3	128	EGA		02/00-12/07	ITL16	5349	1.1	-	ITL16TT	ITL16TT	6
3.3 AWD	128	EGA		02/00-12/07	ITL16	5349	1.1	-	ITL16TT	ITL16TT	6
CHARGER (05-10)											
2.7	141	EER		01/07-12/10	ITL20	5350	1.1	-	-	-	6
5.7 R/T	254	EZA		12/07-12/07	ITL16	5349	1.1	-	ITL16TT	ITL16TT	8
6.1 SRT8	317	ESF		01/07-12/10	ITL20	5350	1.1	-	-	-	8
CHARGER (11-)											
3.6	218	ERB		09/11-	SXU22HCR11S	3461	1.1	-	-	VXUHC22G	6
5.7 R/T	276	EZH		09/11-	SK16HR11	3417	1.1	-	IKH16TT	IKH16TT	8
5.7 R/T AWD	276	EZH		09/11-	SK16HR11	3417	1.1	-	IKH16TT	IKH16TT	8
6.4 SRT8	351	ESG		09/11-	ITL20	5350	1.1	-	-	-	8
DURANGO (03-10)											
3.7	157	EKG		11/03-12/10	KJ20CR-L11	3169	1.1	K20TT	IK20TT	IK20TT	6
3.7 AWD	157	EKG		11/03-12/10	KJ20CR-L11	3169	1.1	K20TT	IK20TT	IK20TT	6
5.7 AWD	257	EZA		12/07-12/10	ITL16	5349	1.1	-	ITL16TT	ITL16TT	8
DURANGO (11-)											
5.7	268	EZH		01/11-	ITL16	5349	1.1	-	ITL16TT	ITL16TT	8
5.7 AWD	268	EZH		01/11-	ITL16	5349	1.1	-	ITL16TT	ITL16TT	8
JOURNEY (08-)											
2.0 CRD	103	ECE		06/08-05/11	DG-190		4.4V				4
2.4	125	ED3		01/09-05/11	KJ16CR-U11	3311	1.1	K16TT	IK16TT	IK16TT	4
2.4 ECO+	125	ED3(GPL)	LPG / GPL	03/09-05/11	KJ16CR-U11	3311	1.1	K16TT	IK16TT	IK16TT	4
2.7 FLEXFUEL	136	EER(F186-E85)	Flexible fuel	01/09-05/11	ITL20	5350	1.1	-	-	-	6
3.5	173	EGF		06/08-	ITV20	5339	1.1	-	ITV20TT	ITV20TT	6
3.5 AWD	173	EGF		06/08-	ITV20	5339	1.1	-	ITV20TT	ITV20TT	6
3.6	211	ERB		01/12-	ITV20	5339	1.1	-	ITV20TT	ITV20TT	6
NEON (94-99)											
2.0 16V	98	ECB		05/94-08/99	K20PR-U	3145	0.8	K20TT	IK20TT	IK20TT	4
2.0 Highline	98	ECB		01/94-09/99	K20PR-U	3145	0.8	K20TT	IK20TT	IK20TT	4







Spark & Glow Plugs

Application Tables

	KW				Standard			Twin Tip				QTY
DODGE <i>continued</i>												
NEON (99-)												
2.0 16V	98	ECB		08/99-	K20PR-U	3145	0.8	K20TT	IK20TT	IK20TT		4
NITRO (06-)												
3.7	157	EKG		09/06-12/12	KJ20CR-L11	3169	1.1	K20TT	IK20TT	IK20TT		6
3.7 4WD	157	EKG		09/06-12/12	KJ20CR-L11	3169	1.1	K20TT	IK20TT	IK20TT		6
3.7 V6	154	EKG		06/07-	KJ20CR-L11	3169	1.1	K20TT	IK20TT	IK20TT		6
3.7 V6 4WD	151	EKG		06/07-	KJ20CR-L11	3169	1.1	K20TT	IK20TT	IK20TT		6
4.0 4WD	191	EGS		09/06-12/07	IK16L	5357	1.1	-	IK16TT	IK16TT		6
RAM (01-08)												
3.7	157	EKG		06/01-09/08	KJ20CR-L11	3169	1.1	K20TT	IK20TT	IK20TT		6
5.7	257	EZA		12/07-12/09	ITL16	5349	1.1	-	ITL16TT	ITL16TT		8
RAM (08-)												
5.7 4x4	291	EZH		01/11-	ITL16	5349	1.1	-	ITL16TT	ITL16TT		8
STRATUS (95-01)												
2.0 16V	98	ECB		12/95-04/01	K20PR-U	3145	0.8	K20TT	IK20TT	IK20TT		4
2.4 16 V	103	EDZ		12/95-04/01	K16R-U11	3120	1.1	K16TT	IK16TT	IK16TT		4
2.4 16V	112	EDZ		12/95-04/01	K16R-U11	3120	1.1	K16TT	IK16TT	IK16TT		4
VIPER (02-)												
SRT-10	372	EWC		09/02-	QJ16AR-U	3235	0.8	-	-	-		10
DR												
DR 1 (10-)												
1.0	50	SQR472F		03/10-	K20PR-U	3145	0.8	K20TT	IK20TT	IK20TT		4
1.3	61	SQR473		03/10-	K20PR-U	3145	0.8	K20TT	IK20TT	IK20TT		4
DR 2 (10-)												
1.3	61	SQR473		09/10-	K20PR-U	3145	0.8	K20TT	IK20TT	IK20TT		4
DR 5 (11-)												
1.6	80/87	SQR481F		01/11-	K20PR-U	3145	0.8	K20TT	IK20TT	IK20TT		4
1.8	97			01/11-	K20PR-U	3145	0.8	K20TT	IK20TT	IK20TT		4
2.0	94/ 102	SQR484F		01/11-	K20PR-U	3145	0.8	K20TT	IK20TT	IK20TT		4
2.0 4WD	102	SQR484F		01/11-	K20PR-U	3145	0.8	K20TT	IK20TT	IK20TT		4
FAW												
V2 (13-)												
1.3i	67	CA4GA1		10/13-	K20R-U11	3139	1.1	K20TT	IK20TT	IK20TT		4
V5 (12-)												
1.5i	75			01/12-	XU22EPR-U	3179	0.9	XU22TT	-	VXU22		4
FERRARI												
208 / 308 (75-89)												
208 Turbo	162	F 106 D..		06/82-10/89	IW29	5318	0.7	-	-	-		8
308 GTB Qv	177	F 105 A..		09/82-06/85	IW24	5316	0.7	-	-	-		8
308 GTS Qv	177	F 105 A..		09/82-06/85	IW24	5316	0.7	-	-	-		8
328 GTB (85-89)												
3.2	199	F 105 C..		09/85-09/89	IX24	5372	0.8	-	-	-		8
328 GTS (85-89)												
3.2	199	F 105 C..		09/85-09/89	IX24	5372	0.8	-	-	-		8
348 Spider (93-95)												
3.4	235			03/93-12/95	IX24	5372	0.8	-	-	-		8
348 TB / GTB (90-94)												
3.4	221/ 235	F 119 D 040; F 119 F 000		02/90-04/94	IX24	5372	0.8	-	-	-		8
348 TS / GTS (90-95)												
3.4	221/ 235	F 119 D 040; F 119 F 000		08/90-12/95	IX24	5372	0.8	-	-	-		8
360 Modena (99-05)												
3.6	294	F 131 B40		02/00-03/05	IU24	5362	0.9	-	-	-		8
3.6 Challenge	305			05/01-03/05	IU24	5362	0.9	-	-	-		8
3.6 Challenge Stradale	313			05/03-03/05	IU24	5362	0.9	-	-	-		8
3.6 Modena	294/ 316	F 131 B40; F 131 B44		03/99-03/05	IU24	5362	0.9	-	-	-		8
400 i (79-85)												
4.8	232	F 101..		05/79-03/85	W22EPR-U	3088	0.8	W22TT	-	VW22		12
412 i (85-88)												
4.9	250	F 101 E..		04/85-12/88	IW24	5316	0.7	-	-	-		12
456 GT / GTA (93-04)												
5.5 (F116)	325	F 116 B 00		01/93-06/04	IXU27	5337	0.9	-	-	-		12
550 BARCETTA (00-05)												
5.5	357	F 133		10/00-01/05	IXU27	5337	0.9	-	-	-		12
550 Maranello (96-02)												
550	357	F 133		09/96-	IXU27	5337	0.9	-	-	-		12







Spark & Glow Plugs

Application Tables

	KW					Standard		Twin Tip		QTY
FERRARI <i>continued</i>										
575 Maranello (02-06)										
575 M	380			04/02-12/06	IXU27	5337	0.9	-	-	12
599 GTB / GTO (06-)										
6.0 GTB	456			06/06-	IU24	5362	0.9	-	-	12
6.0 GTO	489/ 493			04/10-	IU24	5362	0.9	-	-	12
612 SCAGLIETTI (04-11)										
5.7	397	F 118 B 42		04/04-06/11	IXU27	5337	0.9	-	-	12
DINO GT4 (74-80)										
308	188			02/74-06/80	W22EPR-U	3088	0.8	W22TT	-	8
ENZO (02-03)										
6.0	485	F 140 B49		10/02-12/03	IU24	5362	0.9	-	-	12
F40 (88-92)										
3.0	352	F 120 A		02/88-06/92	U24ES-N	4196	0.8	-	-	8
F50 (95-97)										
4.7	383	F 130 B12		05/95-10/97	IU22	5361	0.9	-	-	12
F355 (94-00)										
3.5	280	F 129B/40		05/94-03/99	IU22	5361	0.9	-	-	8
3.5 Spider	280	F 129B/40		07/94-12/00	IU22	5361	0.9	-	-	8
F430 (Spider) (05-09)										
4.3	357/ 360/ 372/ 375/ 376	F 131 B43; F 131 B47		04/07-12/09	IU24	5362	0.9	-	-	8
MONDIAL (80-93)										
3.2	188			10/87-09/89	IX24	5372	0.8	-	-	8
3.2 Quattrovalvole	199	F 105 C..		09/85-12/88	IX24	5372	0.8	-	-	8
3.4 T	221	F 119 D		01/89-12/93	IX24	5372	0.8	-	-	8
8	158	F 105 A..		07/80-09/83	IW24	5316	0.7	-	-	8
8 Quattrovalvole	177	F 105 A..		10/82-07/87	IW24	5316	0.7	-	-	8
TESTAROSSA (84-91)										
5.0	272/ 287	F 113 A..; F 113 B..		05/84-12/91	IX24	5372	0.8	-	-	12
FIAT										
124 (66-85)										
1600 Sport (BS)	82			11/69-08/73	W22EPR-U	3088	0.8	W22TT	-	4
125 (67-74)										
1.6 (TA)	66/74	125 A.000; 125 B.000		07/67-03/74	W22EPR-U	3088	0.8	W22TT	-	4
126 (72-00)										
600	17	126 A.000		09/72-06/77	W22FPR-U	4022	0.7	-	-	2
650	22	141 A.000		01/83-06/96	W20EPR-U	3047	0.8	W20TT	IW20TT	2
650	17	126 A1.048		07/77-09/87	W20FP-U	3068	0.7	WF20TT	-	2
650	18	126 A1.048		07/81-12/87	W22EP-U	3085	0.8	W22TT	-	2
700	19	126 A2.048		09/87-12/93	W20EPR-U	3047	0.8	W20TT	IW20TT	2
127 (71-86)										
0.9	29/33	100 GL.048; 127GL.000		06/71-05/83	W20EPR-U	3047	0.8	W20TT	IW20TT	4
1.0	37	127 A.000		04/77-06/81	IW20	5306	1.1	-	IW20TT	4
1.0	37	127A.000		01/86-12/86	W20EPR-U	3047	0.8	W20TT	IW20TT	4
1.0 Sport	51	127A1.000		07/78-02/82	W20EPR-U	3047	0.8	W20TT	IW20TT	4
1.3 D	33	127 A5.000		06/81-12/86	DG-001		11V			4
1.3 Diesel	33	127 A5.000		04/81-12/86	DG-001		11V			4
1.3 Sport	55	127A3.000		12/81-05/83	W20EPR-U	3047	0.8	W20TT	IW20TT	4
128 (69-84)										
1.1	33/40	128A.000		03/69-09/81	W20EPR-U	3047	0.8	W20TT	IW20TT	4
1.1 (AC 5)	48	128A.000		08/75-02/81	W20EPR-U	3047	0.8	W20TT	IW20TT	4
1.1 (AF)	33/40	128A.000		07/77-07/79	W20EPR-U	3047	0.8	W20TT	IW20TT	4
1.3 (AC)	55	128A1.000		03/72-12/79	W20EPR-U	3047	0.8	W20TT	IW20TT	4
1.3 Berlinetta (AC)	54	128A1.000		06/75-12/79	W20EPR-U	3047	0.8	W20TT	IW20TT	4
131 (74-84)										
1.3 Mirafiori	40/48	131A.000; 131B.000		09/77-09/81	W20EPR-U	3047	0.8	W20TT	IW20TT	4
1.3 Mirafiori (AF)	48	131A.000		09/77-02/81	W20EPR-U	3047	0.8	W20TT	IW20TT	4
1.3 Super Mirafiori	57	131B.000		03/78-12/80	W20EPR-U	3047	0.8	W20TT	IW20TT	4
1.4 Mirafiori	51	131C1.000		11/80-01/84	W20EPR-U	3047	0.8	W20TT	IW20TT	4
1.4 Super Mirafiori	55	131C1.000		04/81-01/82	W20EPR-U	3047	0.8	W20TT	IW20TT	4
1.6	63	131A1.000;131B1.00 0; 131A1.000		11/76-12/84	W20EPR-U	3047	0.8	W20TT	IW20TT	4
1.6 (S)	55	131A1.000		09/77-09/81	W20EPR-U	3047	0.8	W20TT	IW20TT	4
1.6 CL (AF1)	55	131A1.000		09/77-12/78	W20EPR-U	3047	0.8	W20TT	IW20TT	4
1.6 Super	71	131A1.000;131B1.00		03/78-02/81	W20EPR-U	3047	0.8	W20TT	IW20TT	4



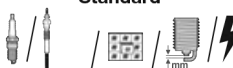





Spark & Glow Plugs







Application Tables







	KW				 Standard			 Twin Tip				QTY
FIAT continued												
131 (74-84) continued												
1.6 Super Mirafiori (A)	72	131 B1.000		03/79-07/80	IW20	5306	1.1	-	IW20TT	IW20TT		4
2.0 D	44	8144.65		07/78-08/84	DG-001		11V					4
2.0 Super	83	131C4.000		01/81-01/82	W20EPR-U	3047	0.8	W20TT	IW20TT	IW20TT		4
2.5 D	53	8144.61		06/78-02/84	DG-001		11V					4
2.5 Super Diesel (AF)	53	8144.61		03/79-12/84	DG-001		11V					4
132 (72-82)												
1.6	65/ 66/ 72	132C.000		04/77-08/81	W20EPR-U	3047	0.8	W20TT	IW20TT	IW20TT		4
2.0	82	132C2.000		05/77-06/81	W20EPR-U	3047	0.8	W20TT	IW20TT	IW20TT		4
2.0 D	44	8144.65		07/78-07/82	DG-001		11V					4
2.0 GLS	84	132C2.000		01/76-12/76	W20EPR-U	3047	0.8	W20TT	IW20TT	IW20TT		4
2.0 i.e.	90	132C2.000;132DB.2A		01/80-08/81	W20EPR-U	3047	0.8	W20TT	IW20TT	IW20TT		4
2.5 D	53	8144.61		07/78-07/82	DG-001		11V					4
147 (76-96)												
1.3 D	33/36	127 A5.000		10/80-10/95	DG-001		11V					4
242-SERIE (75-82)												
2.5 D	52	B 25.637		08/80-07/82	DG-001		11V					4
500 (C) (07-)												
1.2	51	169 A4.000		10/07-	XU22EPR-U	3179	0.9	XU22TT	-	VXU22		4
1.2 LPG	51	169 A4.000		12/10-	VXU22	5608	0.9	-	-	VXU22		4
1.3 D Multijet	55	169 A1.000		10/07-	DG-171		11V					4
1.3 D Multijet	70	199 B1.000		09/09-	DG-621		4.4V					4
1.4	74/ 75/ 99	169 A3.000; 312 A1.000		09/09-	XU22EPR-U	3179	0.9	XU22TT	-	VXU22		4
1.4 Abarth	99/ 103/ 118/ 132/ 139	312 A1.000; 312 A3.000		08/08-	IXU27	5337	0.9	-	-	-		4
500 (57-76)												
0.5	13	110 F.000; 120.000		01/65-12/75	W20FSR-U	6053	0.7	WF20TT	-	-		2
500L (12-)												
1.3 D Multijet	62	199 B4.000		09/12-	DG-621		4.4V					4
1.4	70	843 A1.000		09/12-	XU22EPR-U	3179	0.9	XU22TT	-	VXU22		4
1.6 D Multijet	77/88	199 B5.000; 955 A3.000		09/12-	DG-608		4.4V					4
900 T/E Panorama (78-86)												
0.9	26	100 GF 000		01/78-12/81	W20EPR-U	3047	0.8	W20TT	IW20TT	IW20TT		4
900 T/E Pulmino (78-86)												
0.9	26	100 GF 000		01/78-12/81	W20EPR-U	3047	0.8	W20TT	IW20TT	IW20TT		4
ARGENTA (78-86)												
1600	72	132 D.000		04/81-12/85	W20EPR-U	3047	0.8	W20TT	IW20TT	IW20TT		4
1600 i.e	66	132D3.000		04/81-12/85	W20EPR-U	3047	0.8	W20TT	IW20TT	IW20TT		4
2000	83	132 C2.000		01/81-12/85	W20EPR-U	3047	0.8	W20TT	IW20TT	IW20TT		4
2000 i.e.	90	132 C3.000		01/83-07/86	W20EPR-U	3047	0.8	W20TT	IW20TT	IW20TT		4
2000 Volumex	99	132E		06/84-07/85	W20EPR-U	3047	0.8	W20TT	IW20TT	IW20TT		4
2500 Diesel	53	8144.61		06/81-11/85	DG-001		11V					4
2500 Turbodiesel	66	8144.61.500.81		07/83-08/85	DG-001		11V					4
BARCETTA (95-05)												
1.8 16V	96	183 A1.000		04/95-05/05	K20TNR	3304	1.0	K20TT	IK20TT	IK20TT		4
BRAVA (95-02)												
1.2 16V	64	182 B2.000		12/98-12/02	XU24EPR-U	3312	0.9	-	-	VXU24		4
1.2 16V 80	59/60	182 B2.000; 188 A5.000		12/98-12/02	XU24EPR-U	3312	0.9	-	-	VXU24		4
1.4 (182.BG)	55	182 A5.000		10/95-10/01	K20TNR	3304	1.0	K20TT	IK20TT	IK20TT		4
1.4 12 V (182.BA)	59	182 A3.000		10/95-08/98	K20TNR	3304	1.0	K20TT	IK20TT	IK20TT		4
1.6 16V (182.BB)	76	182 A4.000		02/96-10/01	K20TNR	3304	1.0	K20TT	IK20TT	IK20TT		4
1.6 16V (182.BH)	66	182 A6.000		10/95-10/01	K20TNR	3304	1.0	K20TT	IK20TT	IK20TT		4
1.6 16V (182.BU)	76	182B6.000		01/99-12/02	K16PR-U	3191	0.8	K16TT	IK16TT	IK16TT		4
1.8 GT 16V (182.BC)	83	182 A2.000		10/95-10/01	K20TNR	3304	1.0	K20TT	IK20TT	IK20TT		4
1.9 D	48	160 A7.000		10/95-03/96	DG-001		11V					4
1.9 JTD	74	182 B9.000		09/00-10/01	DG-122		11V					4
1.9 JTD 105	77	182 B4.000		11/99-10/01	DG-122		11V					4
1.9 JTD 105	77	182 B4.000		12/98-10/99	DG-127		11V					4
1.9 TD 100 S (182.BF)	74	182 A7.000		03/96-10/01	DG-102		11V					4
1.9 TD 75 S (182.BF)	55	182 A8.000		03/96-10/01	DG-102		11V					4
2.0	113	182 B7.000		09/98-08/00	K20TNR	3304	1.0	K20TT	IK20TT	IK20TT		5









Spark & Glow Plugs







Application Tables

	KW					Standard			Twin Tip		QTY
FIAT continued											
BRAVO I (95-01)											
1.2 16V 80	59/60/64	182 B2.000; 188 A5.000		12/98-10/01	XU24EPR-U	3312	0.9	-	-	VXU24	4
1.4 (182.AA)	59	182 A3.000		10/95-10/01	K20TNR	3304	1.0	K20TT	IK20TT	IK20TT	4
1.4 (182.AG)	55	182 A5.000		10/95-10/01	K20TNR	3304	1.0	K20TT	IK20TT	IK20TT	4
1.6	76	182B6.000		09/00-10/01	K16PPR-U	3191	0.8	K16TT	IK16TT	IK16TT	4
1.6 16V (182.AB)	76	182 A4.000		03/96-10/01	K20TNR	3304	1.0	K20TT	IK20TT	IK20TT	4
1.6 16V (182.AH)	66	182 A6.000		10/95-10/01	K20TNR	3304	1.0	K20TT	IK20TT	IK20TT	4
1.8 GT (182.AC)	83	182 A2.000		10/95-10/01	K20TNR	3304	1.0	K20TT	IK20TT	IK20TT	4
1.9 D	48	160 A7.000		10/95-03/96	DG-001		11V				4
1.9 JTD	74	182 B9.000		09/00-10/01	DG-122		11V				4
1.9 JTD 105	77	182 B4.000		11/99-10/01	DG-122		11V				4
1.9 JTD 105	77	182 B4.000		12/98-10/99	DG-127		11V				4
1.9 TD 100 S (182.AF)	74	182 A7.000		03/96-10/01	DG-102		11V				4
1.9 TD 75 S (182.AF)	55	182 A8.000		03/96-10/01	DG-102		11V				4
2.0 HGT 20V (182.AD)	108	182 A1.000		10/95-07/98	K20TNR	3304	1.0	K20TT	IK20TT	IK20TT	5
2.0 HGT 20V (182.AQ)	113	182 B7.000		07/98-08/00	K20TNR	3304	1.0	K20TT	IK20TT	IK20TT	5
BRAVO II (06-)											
1.4	66	192 B2.000		04/07-	XU22EPR-U	3179	0.9	XU22TT	-	VXU22	4
1.4 16V	103	198 A7.000		03/08-	IXU27	5337	0.9	-	-	-	4
1.4 LPG	66	192 B2.000		11/09-	XU22EPR-U	3179	0.9	XU22TT	-	VXU22	4
1.4 T-Jet	88/110	198 A1.000; 198 A4.000		09/07-	IXU27	5337	0.9	-	-	-	4
1.6 D Multijet	66/77/88	198 A2.000; 198 A3.000; 198 A6.000; 844 A3.000		03/08-	DG-608		4.4V				4
1.9 D Multijet	110	937 A5.000		04/07-	DG-170		11V				4
1.9 D Multijet	85/88	192 A1.000; 192 A8.000; 192 B4.000		11/06-12/09	DG-196		11V				4
2.0 D Multijet	120/121	198 A5.000; 198 A8.000; 844 A2.000		09/08-	DG-608		4.4V				4
CAMPAGNOLA (74-89)											
2.4 D	53	8144.61.200		06/74-10/89	DG-001		11V				4
CINQUECENTO (91-99)											
0.7 (170AA)	23	170 A.000		12/91-01/96	W20EPR-U	3047	0.8	W20TT	IW20TT	IW20TT	2
0.7 i (170AD)	22	170 A.046		07/94-01/98	W20EPR-U	3047	0.8	W20TT	IW20TT	IW20TT	2
0.9 (170AB)	30	170 A1.000		07/91-12/93	W20EPR-U	3047	0.8	W20TT	IW20TT	IW20TT	4
0.9 i.e. (170AC)	30	170 A1.046		07/91-12/93	W20EPR-U	3047	0.8	W20TT	IW20TT	IW20TT	4
0.9 i.e. S (170AF, 170CF)	29	1170 A1.046		07/91-07/99	W20EPR-U	3047	0.8	W20TT	IW20TT	IW20TT	4
1.1 Sporting (170AH)	40	176 B2.000		10/94-01/98	K20TNR	3304	1.0	K20TT	IK20TT	IK20TT	4
COUPE (93-00)											
1.8 16V	96	183 A1.000		03/96-08/00	K20TNR	3304	1.0	K20TT	IK20TT	IK20TT	4
2.0 16V	102	836 A3.000		11/93-08/96	W22EPR-U	3088	0.8	W22TT	-	VW22	4
2.0 16V Turbo	140	175 A1.000		11/93-08/96	W22EPB	5066	0.85	W22TT	-	VW22	4
2.0 20V	108/113	182 A1.000; 182B3.000		08/96-08/00	K20TNR	3304	1.0	K20TT	IK20TT	IK20TT	5
2.0 20V Turbo	162	175 A3.000		08/96-08/00	K20PBR-S10	5061	1.0	K20TT	IK20TT	IK20TT	5
CROMA (85-96)											
1600	61	154A.000;154A.048		12/85-12/90	W22EPR-U	3088	0.8	W22TT	-	VW22	4
1900 Turbo D i.d.	69	154 D1.000		11/92-12/96	DG-132		11V				4
1900 Turbo D i.d. (154.LL, 154.PL)	66	154 C6.000		05/89-10/92	DG-132		11V				4
2000 16V	101	154 E1.000		08/92-08/96	W22EPR-U	3088	0.8	W22TT	-	VW22	4
2000 CHT	74			01/91-09/92	W22EPR-U	3088	0.8	W22TT	-	VW22	4
2000 CHT (154.AC)	66	154 A1.000		12/85-02/89	W22EPR-U	3088	0.8	W22TT	-	VW22	4
2000 i.e. (154.AD)	88	834B.000		03/87-12/90	W22EPR-U	3088	0.8	W22TT	-	VW22	4
2000 i.e. (154.AM)	83	154C		03/86-09/90	W22EPR-U	3088	0.8	W22TT	-	VW22	4
2000 i.e. (154.AM, 154.LM)	85	154 C3.046		01/91-12/93	W22EPR-U	3088	0.8	W22TT	-	VW22	4
2000 i.e. Turbo	111	834 C.146		11/86-11/88	W20EPBR-S	5067	0.85	W20TT	IW20TT	IW20TT	4
2000 i.e. Turbo (154.AM)	114	154A2.000		12/85-06/90	W22EPR-U	3088	0.8	W22TT	-	VW22	4
2000 i.e. Turbo (154.AM, 154.LM)	110	154 C4.046		06/87-08/96	W20EPBR-S	5067	0.85	W20TT	IW20TT	IW20TT	4
2500 D	55	8144.67		12/85-12/89	DG-001		11V				4
2500 TD (154.AE)	74	8144.91.2000		12/85-08/89	DG-001		11V				4
2500 TD (154.LL, 154.PL)	85	8144.97; 8144.97.2400		05/89-12/93	DG-001		11V				4
2500 TDE	77	8144.97 S		12/91-08/96	DG-001		11V				4
2500 V6	119	834G.000		06/93-08/96	W22EPR-U	3088	0.8	W22TT	-	VW22	6

	KW					Standard		Twin Tip		QTY	
FIAT continued											
CROMA (05-)											
1.8 16V	103	939 A4.000		12/05-	KJ16CR-L11	3132	1.1	K16TT	IK16TT	IK16TT	4
1.9 D Multijet	85	939 A7.000		06/05-	DG-122		11V				4
1.9 D Multijet	110	939 A2.000		06/05-	DG-170		11V				4
1.9 D Multijet	88	939 A1.000		06/05-	DG-196		11V				4
2.2 16V	108	194 A1.000		06/05-	PT16VR13	5068	1.3	TV16TT	ITV16TT	ITV16TT	4
2.4 D Multijet	147	939 A3.000		06/05-	DG-170		11V				5
DOBLO (01-)											
1.2 (223AXA1A)	48	223A5.000		03/01-01/04	K16PR-U	3191	0.8	K16TT	IK16TT	IK16TT	4
1.2 (223ZXA1A)	48	223A5.000		03/01-01/04	K16PR-U	3191	0.8	K16TT	IK16TT	IK16TT	4
1.3 D Multijet	55/62	199 A2.000; 223 A9.000		10/05-	DG-171		11V				4
1.3 JTD	55	199 A2.000		05/05-	DG-171		11V				4
1.3 JTD 16V	51	188 A8.000; 188 A9.000		05/04-12/06	DG-171		11V				4
1.3 JTD 16V Multijet	62	223 A9.000		08/06-	DG-171		11V				4
1.4	57	350 A1.000		10/05-	XU22EPR-U	3179	0.9	XU22TT	-	VXU22	4
1.6	68	182B6.000		09/02-	K16PR-U	3191	0.8	K16TT	IK16TT	IK16TT	4
1.6 16V (223AXD1A)	76	182B6.000		10/01-12/05	K16PR-U	3191	0.8	K16TT	IK16TT	IK16TT	4
1.6 16V (223ZXD1A)	76	182B6.000		10/01-12/03	K16PR-U	3191	0.8	K16TT	IK16TT	IK16TT	4
1.6 Natural Power	76	182B6.000-GNV	Flexible fuel	01/04-12/05	K16PR-U	3191	0.8	K16TT	IK16TT	IK16TT	4
1.6 Natural Power	76	182B6.000-GNV	Flexible fuel	01/04-	K20TNR	3304	1.0	K20TT	IK20TT	IK20TT	4
1.9 D (223AXB1A)	46	223 A6.000		03/01-	DG-129		11V				4
1.9 D (223ZXB1A)	46	223 A6.000		03/01-	DG-129		11V				4
1.9 D Multijet	88	186 A9.000		10/05-	DG-196		11V				4
1.9 JTD	77	223 A7.000; 223 B1.000		07/03-	DG-122		11V				4
1.9 JTD (223AXE1A)	74	182 B9.000; 223 B2.000		10/01-	DG-122		11V				4
1.9 JTD (223ZXE1A)	74	182 B9.000		10/01-	DG-122		11V				4
1.9 JTD Multijet	88	186 A9.000		12/06-	DG-196		11V				4
DOBLO (10-)											
1.3 D Multijet	66	199 A3.000; 263 A2.000		02/10-	DG-171		11V				4
1.4	70/88	198 A4.000; 843 A1.000		02/10-	XU22EPR-U	3179	0.9	XU22TT	-	VXU22	4
1.4 Natural Power	88	198 A4.000		02/10-	XU22EPR-U	3179	0.9	XU22TT	-	VXU22	4
1.6 D Multijet	66/ 74/ 77	198 A3.000; 263 A3.000; 263 A4.000		02/10-	DG-608		4.4V				4
2.0 D Multijet	99	263 A1.000		02/10-	DG-608		4.4V				4
DUCATO (82-90)											
1.8	49/51	169B		01/82-12/88	W20EPR-U	3047	0.8	W20TT	IW20TT	IW20TT	4
1.9 D	52	149 B1.000		02/87-08/90	DG-001		11V				4
1.9 TD	60	280 A1.000		03/89-08/90	DG-001		11V				4
2.0	62	170D-U8		07/90-08/90	W16EPR-U	3021	0.8	W16TT	IW16TT	IW16TT	4
2.0	58	XN 1T		01/82-08/90	W20EPR-U	3047	0.8	W20TT	IW20TT	IW20TT	4
2.0	55	170 B		07/85-08/90	W20EP-U	3043	0.8	W20TT	IW20TT	IW20TT	4
2.4 D	53	8144.61		01/82-08/90	DG-001		11V				4
2.5 D	55	8144.67; CRD93L (U25-661)		01/86-08/90	DG-001		11V				4
2.5 D 4x4	55	8144.67		01/87-08/90	DG-001		11V				4
2.5 TD	68	8144.21.220; 8144.21		01/86-08/90	DG-001		11V				4
2.5 TD 4x4	68	8144.21		01/86-08/90	DG-001		11V				4
DUCATO (89-94)											
1.9 D	52	149 B1.000		07/90-03/94	DG-001		11V				4
1.9 TD	60	280 A1.000		03/89-03/94	DG-001		11V				4
2.0	62/63	170B;170D-U8		06/90-05/94	W16EPR-U	3021	0.8	W16TT	IW16TT	IW16TT	4
2.0 4x4	63	170D-U8		06/90-05/94	W16EPR-U	3021	0.8	W16TT	IW16TT	IW16TT	4
2.5 D	55	8144.67		07/90-03/94	DG-001		11V				4
2.5 D 4x4	55	8144.67		07/90-03/94	DG-001		11V				4
2.5 TD	70	8140.27		07/90-03/94	DG-001		11V				4
2.5 TD 4x4	70	8140.27		07/90-03/94	DG-001		11V				4
DUCATO (94-02)											
1.9 D	51	230 A2.000		03/94-04/02	DG-001		11V				4
1.9 D	50	D9B (XUD9A); D9B; DJY		04/98-04/02	DG-003		11V				4
1.9 D Combinato	51	230 A2.000		06/95-04/02	DG-001		11V				4
1.9 TD	60/66	230 A3.000; DHX (XUD9TF/L)		03/94-04/02	DG-001		11V				4



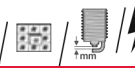

	KW					Standard		Twin Tip		QTY	
FIAT <i>continued</i>											
DUCATO (94-02) <i>continued</i>											
1.9 TD CAT	59	230 A4.000		08/94-04/02	DG-001		11V			4	
1.9 TD Combinato	59	230 A4.000		08/94-04/02	DG-001		11V			4	
1.9 TD Panorama/Combinato	60	230 A3.000		03/94-04/02	DG-001		11V			4	
2.0	74	XU102CU(R5B) - W2		06/94-12/95	K20PR-U	3145	0.8	K20TT	IK20TT	IK20TT	4
2.0	80	RFW		03/94-04/02	Q20PR-U	3007	0.8	Q20TT	IQ20TT	IQ20TT	4
2.0 4x4	80	RFW		11/94-11/01	Q20PR-U	3007	0.8	Q20TT	IQ20TT	IQ20TT	4
2.0 JTD	62	RHV (DW10)		10/01-04/02	DG-116		11V			4	
2.0 Panorama/Combinato	80	RFW		03/94-04/02	Q20PR-U	3007	0.8	Q20TT	IQ20TT	IQ20TT	4
2.5 D	62	8140.67		03/94-04/02	DG-004		11.5V			4	
2.5 D 4x4	62	8140.67		03/94-04/02	DG-004		11.5V			4	
2.5 D Combinato	62	8140.67		08/94-04/02	DG-004		11.5V			4	
2.8 D	64	8140.63		02/98-04/02	DG-111		11V			4	
2.8 D 4x4	64	8140.63		08/98-04/02	DG-111		11V			4	
2.8 JTD	94	8140.43S		11/00-04/02	DG-111		11V			4	
2.8 JTD 4x4	94	8140.43S		11/00-04/02	DG-111		11V			4	
2.8 TDI	90	8140.43		10/97-04/02	DG-111		11V			4	
2.8 TDI 4x4	90	8140.43		06/99-04/02	DG-111		11V			4	
DUCATO (02-)											
2.0	81	RFL		04/02-07/06	K20PR-U	3145	0.8	K20TT	IK20TT	IK20TT	4
2.0 4x4	81	RFL		05/02-07/06	K20PR-U	3145	0.8	K20TT	IK20TT	IK20TT	4
2.0 Bipower	81	RFL(GPL)	Flexible fuel	11/02-06/06	K20PR-U	3145	0.8	K20TT	IK20TT	IK20TT	4
2.0 JTD	62	RHV (DW10)		04/02-	DG-116		11V			4	
2.3 JTD	81	F1AE0481C		04/02-	DG-195		11V			4	
2.8 JTD	94/ 107	8140.43N; 8140.43S		04/02-07/06	DG-111		11V			4	
2.8 JTD 4x4	94	8140.43S		07/02-	DG-111		11V			4	
2.8 JTD Power	107	8140.43N		05/04-	DG-111		11V			4	
DUCATO (06-)											
3.0 D Multijet	130	F1CE3481E		06/11-	DG-195		11V			4	
100 Multijet 2,2 D	74	4HV		07/06-	DG-130		11.5V			4	
115 Multijet 2,0 D	85	250 A1.000		06/11-	DG-608		4.4V			4	
120 Multijet 2,3 D	88	F1AE0481D		07/06-	DG-195		11V			4	
130 Multijet 2,3 D	96	F1AE3481D		01/07-	DG-195		11V			4	
150 Multijet 2,3 D	109	F1AE3481E		06/11-	DG-195		11V			4	
150 Multijet 3,0 D	107	F1CE3481N		04/10-	DG-195		11V			4	
160 Multijet 3,0 D	116	F1CE0481D; F1CE3481M		07/06-	DG-195		11V			4	
DUNA (87-91)											
1.7 DS	44	149 B3.000		01/87-12/91	DG-001		11V			4	
60 1.1	43	146 A6.000; 146A6.000		01/87-12/91	W20EPR-U	3047	0.8	W20TT	IW20TT	IW20TT	4
70 1.3	49	146 A5.000; 146A5.000		01/87-12/91	W20EPR-U	3047	0.8	W20TT	IW20TT	IW20TT	4
ELBA (86-96)											
1.3 D	33	127 A5.000		04/86-10/92	DG-001		11V			4	
1.6	69	146D6.000		01/94-12/96	Q22PR-U	3010	0.8	-	-	VQ22	4
1.7 D	43	146 B2.000		04/89-12/96	DG-001		11V			4	
FIORINO (77-87)											
900	33	127GL.000		10/77-12/84	W20EPR-U	3047	0.8	W20TT	IW20TT	IW20TT	4
1050	37	127 A.000		01/80-12/87	IW20	5306	1.1	-	IW20TT	IW20TT	4
FIORINO (80-93)											
1.0	37/41	127 A.000; 156A.000		10/82-04/88	W20EPR-U	3047	0.8	W20TT	IW20TT	IW20TT	4
1.1	41	156 A.000		09/87-12/88	W20EPR-U	3047	0.8	W20TT	IW20TT	IW20TT	4
1.1 60	40	146 A9.000		11/86-04/88	W20EPR-U	3047	0.8	W20TT	IW20TT	IW20TT	4
1.3	49	146 A5.000		12/87-08/93	W20EPR-U	3047	0.8	W20TT	IW20TT	IW20TT	4
1.3 D	33	127 A5.000		03/82-12/88	DG-001		11V			4	
1.5	55	149 C1.000		01/88-08/93	W22EPR-U	3088	0.8	W22TT	-	VW22	4
1.7 D	42/44	149 B2.000; 149 B3.000		12/87-10/93	DG-001		11V			4	
FIORINO (88-01)											
1.3	49	146A5.000		01/88-12/94	W20EPR-U	3047	0.8	W20TT	IW20TT	IW20TT	4
1.4	49	146 D5.000		05/94-05/01	W20EPR-U	3047	0.8	W20TT	IW20TT	IW20TT	4
1.5 iE	55	149 C1.000		01/88-10/92	W22EPR-U	3088	0.8	W22TT	-	VW22	4
1.6	55	146 D6.000		01/94-05/01	W22EPR-U	3088	0.8	W22TT	-	VW22	4
1.7 D	42/44	146 B2.000; 149 B3.000		05/88-10/99	DG-001		11V			4	
1.7 TD	46	146 D7.000		01/97-05/01	DG-001		11V			4	
60 1.1	40	146 A9.000		05/88-12/93	W20EPR-U	3047	0.8	W20TT	IW20TT	IW20TT	4







	KW								QTY
FIAT continued									
FIORINO (88-01) continued									
60 1.7 D	42/44	146 B2.000; 149 B3.000		05/88-05/00	DG-001		11V		4
65 1.7 TD	46	146 D7.000		01/97-05/01	DG-001		11V		4
70 i.e. 1.4	49	146 D5.000		05/94-05/01	W20EPR-U	3047	0.8	W20TT IW20TT	4
75 i.e. 1.5	55	149 C1.000		05/88-12/93	W22EPR-U	3088	0.8	W22TT - VW22	4
75 i.e. 1.6	55	146 D6.000		10/93-05/01	W22EPR-U	3088	0.8	W22TT - VW22	4
FIORINO (07-)									
1.3 D Multijet	55	199 A2.000		11/07-	DG-171		11V		4
1.3 D Multijet	70	199 B1.000		07/09-	DG-621		4.4V		4
1.4	54	KFV		11/07-	K20PR-U	3145	0.8	K20TT IK20TT	4
1.4 Natural Power	57	350 A1.000		10/09-	VXU22	5608	0.9	- - VXU22	4
FREEMONT (11-)									
2.0 JTD	100/103/125	939 B5.000; 940 A5.000		08/11-	DG-608		4.4V		4
2.0 JTD 4x4	125	939 B5.000		08/11-	DG-608		4.4V		4
3.6	206	ERB		08/11-	ITV20	5339	1.1	- ITV20TT	6
3.6 4x4	206	ERB		08/11-	ITV20	5339	1.1	- ITV20TT	6
GRANDE PUNTO (05-)									
1.2	48	199 A4.000		10/05-	XU22EPR-U	3179	0.9	XU22TT - VXU22	4
1.2	44	188 A4.000	Eng: 2533529>	10/05-12/11	XU22EPR-U	3179	0.9	XU22TT - VXU22	4
1.2	51	169A4.000	Flexible fuel	09/10-12/11	VXU22	5608	0.9	- - VXU22	4
1.2 LPG	51	199 A4.000	Flexible fuel	07/08-	VXU22	5608	0.9	- - VXU22	4
1.3 D Multijet	51/55/56/62/66	199 A2.000; 199 A3.000; 199 B2.000; 199 B4.000; 223 A9.000		10/05-	DG-171		11V		4
1.3 D Multijet	62/70	199 B1.000; 199 B4.000		03/09-	DG-621		4.4V		4
1.3 D Multijet	55	199 A2.000; 199 A9.000	OE: 46796050	04/08-12/11	DG-171		11V		4
1.4	55/57	199 A7.000; 350 A1.000		10/05-	XU22EPR-U	3179	0.9	XU22TT - VXU22	4
1.4 16V	112	198 A1.000		09/07-07/12	IXU27	5337	0.9	- - -	4
1.4 16V	70/77	199 A6.000; 955 A6.000		10/05-	XU22EPR-U	3179	0.9	XU22TT - VXU22	4
1.4 Abarth	114/132	199 A8.000; 955 A8.000		12/07-	IXU27	5337	0.9	- - -	4
1.4 LPG	57	350 A1.000		12/08-	VXU22	5608	0.9	- - VXU22	4
1.4 Natural Power	57	350 A1.000		07/08-	VXU22	5608	0.9	- - VXU22	4
1.4 T-Jet	88	198 A4.000		09/07-	IXU27	5337	0.9	- - -	4
1.6 D Multijet	88	955 A3.000		07/08-	DG-608		4.4V		4
1.9 D Multijet	88/96	199 A5.000; 939 A1.000		10/05-	DG-122		11V		4
IDEA (03-)									
1.2 16V	59	188 A5.000		01/04-	XU24EPR-U	3312	0.9	- - VXU24	4
1.3 D Multijet	66	199 A3.000		10/05-	DG-171		11V		4
1.3 D Multijet	70	199 B1.000	Double Coil(LPH)	05/08-	DG-171		11V		4
1.3 JTD	51	188 A9.000		01/04-	DG-171		11V		4
1.4	57/66	192 B2.000; 350 A1.000		12/03-	XU22EPR-U	3179	0.9	XU22TT - VXU22	4
1.4 16V	70	843 A1.000		01/04-	XU22EPR-U	3179	0.9	XU22TT - VXU22	4
1.4 LPG	57	350 A1.000		03/09-	VXU22	5608	0.9	- - VXU22	4
1.6 D Multijet	88	350 A2.000		05/08-	DG-608		4.4V		4
1.9 JTD	74	188 B2.000		01/04-	DG-122		11V		4
LINEA (07-)									
1.3 D Multijet	66	199 A3.000		06/07-	DG-171		11V		4
1.3 D Multijet	70	199 A3.000		09/09-	DG-621		4.4V		4
1.4	57	350 A1.000		06/07-	XU22EPR-U	3179	0.9	XU22TT - VXU22	4
1.4 T-Jet	88	198 A4.000		09/07-	IXU27	5337	0.9	- - -	4
1.6 D Multijet	77	198 A3.000		06/09-	DG-608		4.4V		4
MAREA (96-07)									
1.2 16V	60	182 B2.000; 182B2.000		10/98-05/02	XU24EPR-U	3312	0.9	- - VXU24	4
1.4 80 12V	59	182 A3.000		09/96-05/02	K20TNR	3304	1.0	K20TT IK20TT	4
1.6	76	182 B6.000		09/00-08/02	K16PR-U	3191	0.8	K16TT IK16TT	4
1.6 100 16V	76	182 A4.000		09/96-05/02	K16PR-U	3191	0.8	K16TT IK16TT	4
1.6 100 16V	76	182 A4.000		09/96-05/02	K20TNR	3304	1.0	K20TT IK20TT	4
1.6 100 16V Bipower	76	185 A3.000		04/99-08/00	K20TNR	3304	1.0	K20TT IK20TT	4

	KW								QTY		
FIAT <i>continued</i>											
MAREA (96-07) <i>continued</i>											
1.6 SX	72	182 B5.098		09/00-08/02	SK16R11	3324	1.1	-	IK16TT	IK16TT	4
1.8 115 16V	83	182 A2.000		09/96-05/02	K20TNR	3304	1.0	K20TT	IK20TT	IK20TT	4
1.9 JTD 105	77	182 B4.000		11/99-05/02	DG-122		11V				4
1.9 JTD 105	77	182 B4.000		04/99-10/99	DG-127		11V				4
1.9 JTD 110	81	186 A6.000		01/01-05/02	DG-122		11V				4
1.9 TD 100	74	182 A7.000; 182 B9.000		09/96-05/02	DG-102		11V				4
1.9 TD 75	55	182 A8.000		09/96-05/02	DG-102		11V				4
2.0 150 20V	108/110	182 A1.000; 185 A8.000		09/96-05/02	K20TNR	3304	1.0	K20TT	IK20TT	IK20TT	5
2.0 155 20V	113	182 B7.000		04/99-02/03	K20TNR	3304	1.0	K20TT	IK20TT	IK20TT	5
2.4 JTD 130	96	185 A6.000; 839 A5.000		11/99-05/02	DG-122		11V				5
2.4 JTD 130	96	185 A6.000; 839 A5.000		04/99-10/99	DG-127		11V				5
2.4 TD 125	91	185 A2.000		09/96-04/99	DG-102		11V				5
MULTIPLA (99-10)											
1.6	68/74/76	182 B6.000; 182B6.000		09/00-06/10	K16PR-U	3191	0.8	K16TT	IK16TT	IK16TT	4
1.6 100 16V (186AXA1A)	76	182 A4.000		04/99-06/10	K20TNR	3304	1.0	K20TT	IK20TT	IK20TT	4
1.6 16V (186AGB1A)	70	182B6.000		04/02-06/10	K16PR-U	3191	0.8	K16TT	IK16TT	IK16TT	4
1.6 16V Bipower (186AMB1A)	76	186A4.000		04/99-06/03	K16PR-U	3191	0.8	K16TT	IK16TT	IK16TT	4
1.6 16V Bipower (186AXC1A)	76	182 B6.000		10/01-06/10	K16PR-U	3191	0.8	K16TT	IK16TT	IK16TT	4
1.6 16V Blupower (186AMA1A)	70	186A3.000		04/99-06/03	K16PR-U	3191	0.8	K16TT	IK16TT	IK16TT	4
1.9 JTD (186AXE1A)	88	186 A9.000		04/02-06/10	DG-122		11V				4
1.9 JTD 105 (186AXB1A)	77	182 B4.000		11/99-06/10	DG-122		11V				4
1.9 JTD 105 (186AXB1A)	77	182 B4.000		04/99-10/99	DG-127		11V				4
1.9 JTD 110	81	186 A6.000		03/01-07/02	DG-122		11V				4
1.9 JTD 115	85	186 A8.000		07/02-06/10	DG-122		11V				4
PALIO (96-)											
1.2	44	188 A4.000		07/97-08/02	K16PR-U	3191	0.8	K16TT	IK16TT	IK16TT	4
1.2	54	176 A8.000; 178 B5.000; 178 E2.000		06/98-	K20TNR	3304	1.0	K20TT	IK20TT	IK20TT	4
1.2	59	188 A5.000		09/01-	XU24EPR-U	3312	0.9	-	-	VXU24	4
1.2 (178DX.G1A)	54	178 B5.000		04/96-02/01	K20PR-U	3145	0.8	K20TT	IK20TT	IK20TT	4
1.2 (178DYA1A)	44	178 C4.066; 188 A4.000		02/01-	K16PR-U	3191	0.8	K16TT	IK16TT	IK16TT	4
1.2 Flex	44	188 A4.000		07/97-08/02	K16PR-U	3191	0.8	K16TT	IK16TT	IK16TT	4
1.2 LPG	44	188 A4.000		07/97-08/02	VK16	5603	1.1	-	IK16TT	IK16TT	4
1.4	51	178 B2.000		04/96-	K16TNR-S9	3329	0.9	K16TT	IK16TT	IK16TT	4
1.4 CAT	51	178 B2.016		04/96-	K16TNR-S9	3329	0.9	K16TT	IK16TT	IK16TT	4
1.5	57			04/96-	K22PR-U	3165	0.8	-	-	VK22	4
1.6 16V	74	178 B3.000		04/96-	K20TNR	3304	1.0	K20TT	IK20TT	IK20TT	4
1.6 16V (178DX.D1A)	74	178 B3.000		07/97-02/01	K20TNR	3304	1.0	K20TT	IK20TT	IK20TT	4
1.6 16V (178DYC1A06)	76	182 B6.000		02/01-	K16PR-U	3191	0.8	K16TT	IK16TT	IK16TT	4
1.7 TD (178DX.H1A)	51	176 A3.000		04/96-03/01	DG-001		11V				4
1.9 D (178DYD1A07)	46	223 A6.000		03/01-	DG-129		11V				4
PANDA (80-04)											
1.1	37	156 C.046		05/91-03/95	Q20PR-U	3007	0.8	Q20TT	IQ20TT	IQ20TT	4
1.1	40	187 A1.000	Ch: >C9081	09/00-02/04	K16PR-U	3191	0.8	K16TT	IK16TT	IK16TT	4
650	22	141 A.000		01/82-12/86	W20FPR-U	3070	0.7	WF20TT	-	-	4
750	25	156A4.000		01/86-02/91	K16PR-U	3191	0.8	K16TT	IK16TT	IK16TT	4
750	25	141B.000		10/89-07/92	W20EPR-U	3047	0.8	W20TT	IW20TT	IW20TT	4
750 (141AA)	25	156 A4.000		01/86-12/93	Q20PR-U	3007	0.8	Q20TT	IQ20TT	IQ20TT	4
750 (141AI)	25	141 B.000		01/86-01/95	W20EP-U	3043	0.8	W20TT	IW20TT	IW20TT	4
750 (141AM) CAT	25	156 A4.048		01/95-10/03	Q20PR-U	3007	0.8	Q20TT	IQ20TT	IQ20TT	4
800	25	100GL6.000		02/81-12/85	W20EPR-U	3047	0.8	W20TT	IW20TT	IW20TT	4
900	29	1170 A1.046		04/92-12/96	W20EPR-U	3047	0.8	W20TT	IW20TT	IW20TT	4
900	33	100 GL3.000		10/80-12/85	W20EP-U	3043	0.8	W20TT	IW20TT	IW20TT	4
950 4x4	35	A112B1.054		09/83-12/86	W20EPR-U	3047	0.8	W20TT	IW20TT	IW20TT	4
1000	32/37	156 A2.100; 156 A3.000		01/85-12/92	Q20PR-U	3007	0.8	Q20TT	IQ20TT	IQ20TT	4
1000 4x4	32/33/37	156 A2.100; 156 A2.246; 156 A3.000		01/86-12/92	Q20PR-U	3007	0.8	Q20TT	IQ20TT	IQ20TT	4
1000 i.e	33	156 A2.246		08/92-02/04	Q20PR-U	3007	0.8	Q20TT	IQ20TT	IQ20TT	4
1000 i.e. CAT	33	156 A2.246		10/87-08/98	Q20PR-U	3007	0.8	Q20TT	IQ20TT	IQ20TT	4

Spark & Glow Plugs







Application Tables





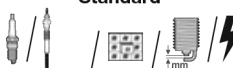

	KW					Standard			Twin Tip			QTY
FIAT <i>continued</i>												
PANDA (80-04) <i>continued</i>												
1100	40	187 A1.000		02/95-09/03	K16PR-U	3191	0.8	K16TT	IK16TT	IK16TT		4
1100	40	176 B2.000		02/95-09/03	K20TNR	3304	1.0	K20TT	IK20TT	IK20TT		4
1100	37	156 C.046		05/91-12/99	Q20PR-U	3007	0.8	Q20TT	IQ20TT	IQ20TT		4
1100 4x4	40	176 B2.000		02/95-07/04	K20TNR	3304	1.0	K20TT	IK20TT	IK20TT		4
1100 Trekking 4x4	37	156 C.046		10/91-12/00	Q20PR-U	3007	0.8	Q20TT	IQ20TT	IQ20TT		4
1300 D	27	156 A5.000		04/86-12/92	DG-001		11V					4
PANDA (03-)												
1.1	40	187 A1.000	Ch: >C9081	09/03-12/04	K16PR-U	3191	0.8	K16TT	IK16TT	IK16TT		4
1.1	40	187 A1.000	Ch: D9081>	01/05-	XU22EPR-U	3179	0.9	XU22TT	-	VXU22		4
1.2	51	169 A4.000		03/10-	XU22EPR-U	3179	0.9	XU22TT	-	VXU22		4
1.2	44	188 A4.000	Eng: >2533528	09/03-09/04	K16PR-U	3191	0.8	K16TT	IK16TT	IK16TT		4
1.2	44	188 A4.000	Eng: 2533529>	10/04-	XU22EPR-U	3179	0.9	XU22TT	-	VXU22		4
1.2 4x4	51	169 A4.000		11/09-	XU22EPR-U	3179	0.9	XU22TT	-	VXU22		4
1.2 4x4	44	188 A4.000	Eng: 2533529>	10/04-	XU22EPR-U	3179	0.9	XU22TT	-	VXU22		4
1.2 LPG	44	188 A4.000		04/09-	VXU22	5608	0.9	-	-	VXU22		4
1.2 LPG	51	169 A4.000		09/10-	XU22EPR-U	3179	0.9	XU22TT	-	VXU22		4
1.2 LPG	44	188 A4.000	Eng: 2533529>	04/09-	XU22EPR-U	3179	0.9	XU22TT	-	VXU22		4
1.2 LPG	51	169 A4.000	Flexible fuel	11/10-12/11	VXU22	5608	0.9	-	-	VXU22		4
1.2 Natural Power	44	188 A4.000		01/07-11/09	VXU22	5608	0.9	-	-	VXU22		4
1.2 Natural Power	44	188 A4.000	Eng: 2533529>	01/07-11/09	XU22EPR-U	3179	0.9	XU22TT	-	VXU22		4
1.3 D Multijet	51/55	169 A1.000; 169 A5.000; 188 A8.000; 188 A9.000; 188A8.000		09/03-	DG-171		11V					4
1.3 D Multijet 4x4	51/55	169 A1.000; 169 A5.000; 188 A8.000; 188 A9.000		10/04-	DG-171		11V					4
1.4	74	169 A3.000		10/06-	XU22EPR-U	3179	0.9	XU22TT	-	VXU22		4
1.4 Natural Power	51/57	350 A1.000		10/09-	XU22EPR-U	3179	0.9	XU22TT	-	VXU22		4
PANDA (12-)												
1.2	51	169 A4.000		02/12-	XU22EPR-U	3179	0.9	XU22TT	-	VXU22		4
1.2 LPG	51	169 A4.000		06/12-	XU22EPR-U	3179	0.9	XU22TT	-	VXU22		4
1.3 D Multijet	55	199 A1.000; 199 A9.000		02/12-	DG-171		11V					4
1.3 D Multijet 4x4	55	199 A1.000; 199 A9.000		06/12-	DG-171		11V					4
PUNTO (93-00)												
1.1	40	176 B2.000		04/96-02/00	K20PR-U	3145	0.8	K20TT	IK20TT	IK20TT		4
1.2 16V	63	176 B9.000		04/97-09/99	XU24EPR-U	3312	0.9	-	-	VXU24		4
1.4 GT Turbo	98	176 A4.000		01/94-09/96	K20PBR	5060	0.85	K20TT	IK20TT	IK20TT		4
1.4 GT Turbo	96	176 B6.000		09/96-09/99	K22PBR-S	5062	0.85	-	-	VK22		4
1.6	65	176 A9.000		01/94-04/97	Q22PR-U	3010	0.8	-	-	VQ22		4
1.7 D	42	176 B3.000		04/94-02/00	DG-001		11V					4
1.7 TD	46/ 51/ 52	176 A3.000; 176 A5.000; 176 B7.000		04/96-02/00	DG-001		11V					4
55 1.1	40	176 B2.000		09/93-09/99	K20PR-U	3145	0.8	K20TT	IK20TT	IK20TT		4
55 1.1	40	176 A6.000		09/93-09/99	Q20PR-U	3007	0.8	Q20TT	IQ20TT	IQ20TT		4
60 1.2	43/44	176 A7.000; 176 B4.000		01/94-06/00	Q20PR-U	3007	0.8	Q20TT	IQ20TT	IQ20TT		4
75 1.2	54	176 A8.000		10/93-09/99	Q20PR-U	3007	0.8	Q20TT	IQ20TT	IQ20TT		4
85 16V 1.2	63	176 B9.000		04/97-06/00	XU24EPR-U	3312	0.9	-	-	VXU24		4
90 1.6	65	176 A9.000		04/94-04/97	Q22PR-U	3010	0.8	-	-	VQ22		4
PUNTO (99-)												
1.2 16V 80 (188.233, .235, .253, .255, .333, .353, .639...)	59	188 A5.000		09/99-	XU24EPR-U	3312	0.9	-	-	VXU24		4
1.2 60	44	188 A4.000	Eng: >2533528	02/00-09/04	K16PR-U	3191	0.8	K16TT	IK16TT	IK16TT		4
1.2 60	44	188 A4.000	Eng: 2533529>	10/04-10/09	XU22EPR-U	3179	0.9	XU22TT	-	VXU22		4
1.2 60 (188.030, .050, .130, .150, .230, .250)	44	188 A4.000		09/99-	K16PR-U	3191	0.8	K16TT	IK16TT	IK16TT		4
1.2 Bifuel	44	188 A4.000	Eng: 2533529>	08/07-	XU22EPR-U	3179	0.9	XU22TT	-	VXU22		4
1.2 Natural Power	44	188 A4.000	Eng: >2533528	09/03-09/04	K16PR-U	3191	0.8	K16TT	IK16TT	IK16TT		4

	KW					Standard		Twin Tip		QTY	
FIAT continued											
PUNTO (99-) continued											
1.2 Natural Power	44	188 A4.000	Eng: 2533529>	10/04-	XU22EPR-U	3179	0.9	XU22TT	-	VXU22	4
1.3 D Multijet	55	188 A9.000		02/05-10/09	DG-171		11V				4
1.3 JTD	51	188 A9.000		06/03-10/05	DG-171		11V				4
1.3 JTD 16V	51	188 A9.000		06/03-	DG-171		11V				4
1.4	70	843 A1.000		09/03-	XU24EPR-U	3312	0.9	-	-	VXU24	4
1.8 130 HGT (188.738, .718)	96	183 A1.000		09/99-	K20TNR	3304	1.0	K20TT	IK20TT	IK20TT	4
1.9 D 60	44	188 A3.000		02/00-10/09	DG-129		11V				4
1.9 DS 60 (188.031, .051, .231, .251)	44	188 A3.000		09/99-	DG-129		11V				4
1.9 JTD	63/74	188 A7.000; 188 B2.000		02/00-	DG-122		11V				4
1.9 JTD 80 (188.237, .257, .337, .357)	59	188 A2.000		09/99-	DG-122		11V				4
PUNTO (12-)											
1.2	51	169 A4.000		03/12-	XU22EPR-U	3179	0.9	XU22TT	-	VXU22	4
1.3 D Multijet	55	199 A2.000; 199 A9.000		03/12-	DG-171		11V				4
1.3 D Multijet	59/62/70	199 B1.000; 199 B4.000; 199 B8.000		03/12-	DG-621		4.4V				4
1.4	57	350 A1.000		03/12-	XU22EPR-U	3179	0.9	XU22TT	-	VXU22	4
1.4 Bifuel	57	350 A1.000		03/12-	VXU22	5608	0.9	-	-	VXU22	4
1.4 Multi Air	77	955 A6.000		03/12-	XU22EPR-U	3179	0.9	XU22TT	-	VXU22	4
1.4 Natural Power	57	350 A1.000		03/12-	VXU22	5608	0.9	-	-	VXU22	4
1.4 Turbo Multi Air	99	955 A2.000		03/12-	IXU27	5337	0.9	-	-	-	4
PUNTO EVO (08-12)											
1.2	48/51	169 A4.000; 199 A4.000		10/09-02/12	XU22EPR-U	3179	0.9	XU22TT	-	VXU22	4
1.3 D Multijet	51/55/62/66	199 A2.000; 199 A3.000; 199 A9.000; 199 B2.000; 223A9.000		07/08-02/12	DG-171		11V				4
1.3 D Multijet	70	199 B1.000		10/09-12/11	DG-621		4.4V				4
1.4	55/57	199 A7.000; 350 A1.000		07/09-02/12	XU22EPR-U	3179	0.9	XU22TT	-	VXU22	4
1.4 16V	99	955A2.000		10/09-01/11	IXU27	5337	0.9	-	-	-	4
1.4 16V	77	955 A6.000		10/09-02/12	XU22EPR-U	3179	0.9	XU22TT	-	VXU22	4
1.4 Abarth	120/132	199 A8.000; 955 A8.000		07/08-	IXU27	5337	0.9	-	-	-	4
1.4 LPG	57	350 A1.000		03/09-	VXU22	5608	0.9	-	-	VXU22	4
1.4 Natural Power	57	350 A1.000		03/09-	VXU22	5608	0.9	-	-	VXU22	4
1.6 D Multijet	88	955 A3.000		10/09-02/12	DG-608		4.4V				4
QUBO (08-)											
1.3 D Multijet	55	199 A2.000; 199 A9.000		02/08-	DG-171		11V				4
1.3 D Multijet	70	199 B1.000		07/10-	DG-621		4.4V				4
1.4	54	KFV		02/08-	K20PR-U	3145	0.8	K20TT	IK20TT	IK20TT	4
1.4 Natural Power	57	350 A1.000		10/09-	VXU22	5608	0.9	-	-	VXU22	4
REGATA (83-90)											
60 Diesel 1.7	43/44	138 B6.000; 149 B3.000		09/83-03/89	DG-001		11V				4
65 Diesel 1.9	48	149 A1.000		04/84-07/89	DG-001		11V				4
70 1.3	48/50	138 B2.000; 149 A7.000		09/83-07/89	W20EPR-U	3047	0.8	W20TT	IW20TT	IW20TT	4
75 1.5	55	138 C3.048		12/83-07/89	W22EPR-U	3088	0.8	W22TT	-	VW22	4
75 1.5 i.e. CAT	55	138 C2.048		12/86-07/89	W20EPR-U	3047	0.8	W20TT	IW20TT	IW20TT	4
75 i.e. 1.5	55	138 C2.048		07/85-07/89	W20EPR-U	3047	0.8	W20TT	IW20TT	IW20TT	4
80 Turbo Diesel 1.9	59	831 D1.000		05/86-07/89	DG-001		11V				4
85 1.5	60	138B3.000		07/86-04/89	W22EPR-U	3088	0.8	W22TT	-	VW22	4
85 1.5	58	149A5.000		07/86-12/87	W22EPR-U	3088	0.8	W22TT	-	VW22	4
85 1.6	60	149 A.000		10/83-12/88	W20EPR-U	3047	0.8	W20TT	IW20TT	IW20TT	4
85 Super 1.5	60	138B3.000		09/83-04/85	W20EPR-U	3047	0.8	W20TT	IW20TT	IW20TT	4
90 i.e. 1.6	66	149 C2.000		01/87-07/89	W20EPR-U	3047	0.8	W20TT	IW20TT	IW20TT	4
100 1.6 (RF)	74	149 A4.000		09/84-12/86	W22EPR-U	3088	0.8	W22TT	-	VW22	4
100 i.e. 1.6	74	149 C3.000		01/87-12/90	W20EPR-U	3047	0.8	W20TT	IW20TT	IW20TT	4
100 Super 1.6	70/74	149 A4.000; 149 C3.000		01/85-07/89	W20EPR-U	3047	0.8	W20TT	IW20TT	IW20TT	4
RITMO (78-88)											
55 Diesel 1.7	40/43	138 A5.000		10/79-09/82	DG-001		11V				4
60 1.0	44	127A6.000		02/80-09/82	W20EPR-U	3047	0.8	W20TT	IW20TT	IW20TT	4

Spark & Glow Plugs







Application Tables







	KW				 Standard			 Twin Tip				QTY
FIAT continued												
RITMO (78-88) continued												
60 1.1	40/43	138 B1.000; 146 A4.048		10/82-12/87	W20EPR-U	3047	0.8	W20TT	IW20TT	IW20TT		4
60 Diesel 1.7	43/44	138 B6.000; 138 C.000; 149 B3.000		10/82-12/87	DG-001		11V					4
65 1.3	48	138A1.000		01/78-09/82	W20EPR-U	3047	0.8	W20TT	IW20TT	IW20TT		4
70 1.3	48/50	138 B2.000; 149 A7.000		01/83-08/85	W20EPR-U	3047	0.8	W20TT	IW20TT	IW20TT		4
75 1.3	55	128A3.000		01/81-09/82	W20EPR-U	3047	0.8	W20TT	IW20TT	IW20TT		4
75 1.5	55	138 C3.048; 138B3.000; 138C2.048; 149A5.000		01/78-12/88	W22EPR-U	3088	0.8	W22TT	-	VW22		4
75 1.5 CAT	55	138 C2.048		09/85-12/88	W20EPR-U	3047	0.8	W20TT	IW20TT	IW20TT		4
75 i.e. 1.5	55	138 C2.048		10/85-05/87	W20EPR-U	3047	0.8	W20TT	IW20TT	IW20TT		4
80 Turbo Diesel 1.9	59	831 D1.000		12/85-12/87	DG-001		11V					4
85 1.5	63	138AE.000		01/81-05/87	W20EPR-U	3047	0.8	W20TT	IW20TT	IW20TT		4
85 1.5	58/60	138 B3.000; 149 A5.000		01/83-12/87	W22EPR-U	3088	0.8	W22TT	-	VW22		4
90 1.6 i.e.	66	149C2.000	Ch: >4.880.207	12/85-12/87	W20EPR-U	3047	0.8	W20TT	IW20TT	IW20TT		4
90 1.6 i.e.	66	149C2.000	Ch: 4.880.208>	12/85-12/87	W22EPR-U	3088	0.8	W22TT	-	VW22		4
90 i.e. 1.6	66	149 C2.000		09/85-12/87	W20EPR-U	3047	0.8	W20TT	IW20TT	IW20TT		4
100 1.6	74	138AR.000		01/83-03/85	W20EPR-U	3047	0.8	W20TT	IW20TT	IW20TT		4
105 1.6	77	138 AR.000		01/83-12/87	W20EPR-U	3047	0.8	W20TT	IW20TT	IW20TT		4
105 Sport 1.6	77	138 AR.000		05/81-12/82	W20EPR-U	3047	0.8	W20TT	IW20TT	IW20TT		4
125 TC Abarth 2.0	92	138 AR1.000		11/81-12/87	W22EPR-U	3088	0.8	W22TT	-	VW22		4
130 TC Abarth 2.0	96	138 AR2.000		04/83-12/87	W22EPR-U	3088	0.8	W22TT	-	VW22		4
RITMO Bertone (79-89)												
85 1.5	63	138A2.000		11/82-03/85	W20EPR-U	3047	0.8	W20TT	IW20TT	IW20TT		4
85 1.5	60/63	138 B3.000; 138A4.000		03/83-01/88	W22EPR-U	3088	0.8	W22TT	-	VW22		4
100 1.6	74/77	149A4.048	Ch: >4.880.207	10/85-12/87	W20EPR-U	3047	0.8	W20TT	IW20TT	IW20TT		4
100 1.6	74/77	149A4.048	Ch: 4.880.208>	10/85-12/87	W22EPR-U	3088	0.8	W22TT	-	VW22		4
SCUDO (96-06)												
1.6	58	220 A2.000		02/96-12/06	Q22PR-U	3010	0.8	-	-	VQ22		4
1.9 D	51	D9B		02/96-12/06	DG-001		11V					4
1.9 D	51	WJZ (DW8)		04/98-12/06	DG-003		11V					4
1.9 TD	66/68	D8B; DHX (XUD9TF/L)		02/96-12/06	DG-001		11V					4
1.9 TD Eco	66	DHX (XUD9TF/L)		02/96-12/06	DG-001		11V					4
2.0	100	RFN		05/00-12/06	K16HPR-U11	6076	1.1	KH16TT	IKH16TT	IKH16TT		4
2.0 16V	100	RFN		06/00-12/06	K16HPR-U11	6076	1.1	KH16TT	IKH16TT	IKH16TT		4
2.0 JTD	69/80	RHX; RHZ		12/02-12/06	DG-116		11V					4
2.0 JTD 16V	80	RHW (DW10ATED4)		01/04-12/06	DG-116		11V					4
2.0 JTD 16V	80	RHW (DW10ATED4)		05/99-12/03	DG-181		11V					4
SCUDO (07-)												
1.6 D Multijet	66	9HU		01/07-	DG-180		11V					4
2.0 D Multijet	88/100	RHK; RHR		01/07-	DG-116		11V					4
2.0 D Multijet	88/94/100/120	DW10BTED4; RH02; RHH; RHK; RHR		01/07-	DG-181		11V					4
SEDICI (06-)												
1.6 16V	79/88	M16A		06/06-	VK20	5604	1.1	-	IK20TT	IK20TT		4
1.6 16V 4x4	79/88	M16A		06/06-	VK20	5604	1.1	-	IK20TT	IK20TT		4
1.9 D Multijet	88	D19AA		06/06-	DG-196		11V					4
1.9 D Multijet 4x4	88	D19AA		06/06-	DG-196		11V					4
2.0 D Multijet	99	D20AA		06/06-	DG-608		4.4V					4
2.0 D Multijet 4x4	99	D20AA		06/06-	DG-608		4.4V					4
SEICENTO (98-10)												
0.9 (187AXA)	29	1170 A1.046		01/98-01/10	W20EPR-U	3047	0.8	W20TT	IW20TT	IW20TT		4
0.9 (187AXA, 187AXA1A)	29	1170 A1.046		01/98-01/10	W20EPR-U	3047	0.8	W20TT	IW20TT	IW20TT		4
1.1 (187AXB, 187AXB1A)	40	187 A1.000		10/00-10/04	K16PR-U	3191	0.8	K16TT	IK16TT	IK16TT		4
1.1 (187AXB, 187AXB1A)	40	176 B2.000		01/98-09/00	K20TNR	3304	1.0	K20TT	IK20TT	IK20TT		4
1.1 (187AXB, 187AXB1A)	40	187 A1.000		11/04-01/10	XU22EPR-U	3179	0.9	XU22TT	-	VXU22		4
1.1 (187CXB/C)	40	176 B2.000		01/98-01/10	K20TNR	3304	1.0	K20TT	IK20TT	IK20TT		4
SIENA (96-)												
1.2	44/54	178 B5.000; 178 C4.066; 188 A4.000		09/98-	K16PR-U	3191	0.8	K16TT	IK16TT	IK16TT		4

	KW					Standard		Twin Tip		QTY	
FIAT <i>continued</i>											
SIENA (96-) <i>continued</i>											
1.2	59	188 A5.000		09/01-	XU24EPR-U	3312	0.9	-	-	VXU24	4
1.3 JTD	51	188 A9.000		09/03-	DG-171		11V				4
1.4	57			01/07-	K16PR-U	3191	0.8	K16TT	IK16TT	IK16TT	4
1.4	51	178 B2.000		04/96-	K16TNR-S9	3329	0.9	K16TT	IK16TT	IK16TT	4
1.4 Bipower	60	178 F3.011		06/04-	K16PR-U	3191	0.8	K16TT	IK16TT	IK16TT	4
1.4 CAT	51	178 B2.016		04/96-	K16TNR-S9	3329	0.9	K16TT	IK16TT	IK16TT	4
1.6	76	182 B6.000		11/00-	K16PR-U	3191	0.8	K16TT	IK16TT	IK16TT	4
1.6 16V	78	178 B3.000		09/98-	K16PR-U11	3130	1.1	K16TT	IK16TT	IK16TT	4
STILO (01-08)											
1.2 16V (192_XA1B)	59	188 A5.000		02/02-11/06	XU24EPR-U	3312	0.9	-	-	VXU24	4
1.4 16V	66/70	192 B2.000; 843 A1.000		01/04-08/08	XU22EPR-U	3179	0.9	XU22TT	-	VXU22	4
1.6 16V	76	182 B6.000		01/03-08/08	K16PR-U	3191	0.8	K16TT	IK16TT	IK16TT	4
1.6 16V (192_XB1A)	76	182 B6.000		10/01-11/06	K16PR-U	3191	0.8	K16TT	IK16TT	IK16TT	4
1.8 16V	98	192 A4.000		01/03-08/08	K20PR-U	3145	0.8	K20TT	IK20TT	IK20TT	4
1.8 16V (192_XC1A)	98	192 A4.000		10/01-11/06	K20PR-U	3145	0.8	K20TT	IK20TT	IK20TT	4
1.9 D Multijet	74	192 A9.000		09/05-08/08	DG-122		11V				4
1.9 D Multijet	110	937 A5.000		09/05-08/08	DG-170		11V				4
1.9 D Multijet	88	192 A8.000		09/05-08/08	DG-196		11V				4
1.9 JTD	59/85	192 A1.000; 192 A3.000; 937 A7.000		01/03-08/08	DG-122		11V				4
1.9 JTD	103	192 A5.000		01/04-08/08	DG-170		11V				4
1.9 JTD (192_XE1A)	85	192 A1.000; 937 A7.000		10/01-11/06	DG-122		11V				4
1.9 JTD (192_XF1A)	59	192 A3.000		02/02-11/06	DG-122		11V				4
1.9 JTD (192AXS1B, 192BXS1B)	66	192 B5.000		09/04-11/06	DG-122		11V				4
2.4 20V (192_XD1A)	125	192 A2.000		10/01-11/06	K20TNR	3304	1.0	K20TT	IK20TT	IK20TT	5
STRADA (99-)											
1.2	44	188 A4.000		04/03-	K16PR-U	3191	0.8	K16TT	IK16TT	IK16TT	4
1.2	54	178 B5.000		06/99-	K20TNR	3304	1.0	K20TT	IK20TT	IK20TT	4
1.3 D Multijet	62	223 A9.000		05/06-	DG-171		11V				4
1.7 TD	51	176 A3.000		06/99-	DG-001		11V				4
1.9 D	46	223 A6.000		12/00-	DG-129		11V				4
1.9 JTD	59	188 A2.000		04/03-	DG-122		11V				4
STRADA (10-)											
1.3 D Multijet	70	199 B1.000		10/10-	DG-621		4.4V				4
TALENTO (89-94)											
1.9 D (290UAK, 290UTK)	52	149 B1.000		03/89-03/94	DG-001		11V				4
1.9 D (290UEHK)	52	149 B1.000		03/89-03/94	DG-001		11V				4
1.9 D (290UK)	52	149 B1.000		03/89-03/94	DG-001		11V				4
2.0 (290U4)	55	170 B		03/89-03/94	W20EP-U	3043	0.8	W20TT	IW20TT	IW20TT	4
2.0 (290UA4)	55	170 B		03/89-03/94	W20EP-U	3043	0.8	W20TT	IW20TT	IW20TT	4
2.0 (290UEH4)	55	170 B		03/89-03/94	W20EP-U	3043	0.8	W20TT	IW20TT	IW20TT	4
TEMPRA (90-96)											
1.4 i.e. (159.AC)	57	159 A2.000		03/91-12/93	W20EPR-U	3047	0.8	W20TT	IW20TT	IW20TT	4
1.4 i.e. (159.AC, 159.AX)	51	160 A1.046		03/92-08/96	W20EPR-U	3047	0.8	W20TT	IW20TT	IW20TT	4
1.6	63	159 A3.000		03/90-12/91	W20EPR-U	3047	0.8	W20TT	IW20TT	IW20TT	4
1.6 i.e. (159.AE)	57	159 A3.046		10/90-12/91	Q22PR-U	3010	0.8	-	-	VQ22	4
1.6 i.e. (159.AE)	57	159 A3.046		06/90-07/92	W20EPR-U	3047	0.8	W20TT	IW20TT	IW20TT	4
1.6 i.e. (159.AJ)	63/66	159 B9.000; 159B9.000		06/94-08/96	Q22PR-U	3010	0.8	-	-	VQ22	4
1.6 i.e. (159.AJ)	66	159 B9.000		06/94-08/96	W22EPR-U	3088	0.8	W22TT	-	VW22	4
1.6 i.e. (159.AS, 159.AT)	55	159 A3.048		06/92-08/96	Q22PR-U	3010	0.8	-	-	VQ22	4
1.8 i.e. (159.AN)	77/81	159 A4.046; 159A4.000; 159A4.04		03/90-08/96	W22EPR-U	3088	0.8	W22TT	-	VW22	4
1.8 i.e. (159.AV)	76	835 C2.000		09/93-08/96	W22EPR-U	3088	0.8	W22TT	-	VW22	4
1.8 i.e. (159.AZ)	66	835C2.000; 835C4.000		09/93-08/96	W20EPR-U	3047	0.8	W20TT	IW20TT	IW20TT	4
1.8 i.e. (159.BY)	74	836A5.000		10/94-08/96	W20EPR-U	3047	0.8	W20TT	IW20TT	IW20TT	4
1.9 D (159.AG)	48	160 A7.000		07/91-08/96	DG-001		11V				4
1.9 TD (159.AI, 159.BI, 159.CU, 159.AU)	66	160 A6.000; 160 D1.000		07/91-02/95	DG-001		11V				4
1.9 TD (159.AQ)	59	160 B6.046		03/92-08/96	DG-001		11V				4
1.9 TD (159.CU, 159.AU, 159.AI, 159.BI)	66	160 A6.000; 160 D1.000		05/90-08/96	DG-001		11V				4
2.0 i.e. (159.AP)	83	159 A6.046		10/90-08/96	W22EPR-U	3088	0.8	W22TT	-	VW22	4
2.0 i.e. 4x4 (159.AP)	83	159 A6.046		03/92-03/95	W22EPR-U	3088	0.8	W22TT	-	VW22	4

Spark & Glow Plugs



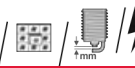



Application Tables

	KW					Standard			Twin Tip			QTY
FIAT continued												
TIPO (87-95)												
1.1 (160.AA)	41	160 A3.000		01/88-10/91	Q20PR-U	3007	0.8	Q20TT	IQ20TT	IQ20TT		4
1.4 (160.AC)	52	160 A1.048		07/87-12/89	W20EPR-U	3047	0.8	W20TT	IW20TT	IW20TT		4
1.4 i.e.	57	159 A2.000		11/92-04/95	IW20	5306	1.1	-	IW20TT	IW20TT		4
1.4 i.e. (160.AP, 160.AD, 160.EA)	51	160 A1.046		05/89-04/95	W20EPR-U	3047	0.8	W20TT	IW20TT	IW20TT		4
1.6 (160.AE)	61	160 A2.000		01/88-10/91	W22EPR-U	3088	0.8	W22TT	-	VW22		4
1.6 i.e.	66	149 C2.046		02/88-05/91	W22EPR-U	3088	0.8	W22TT	-	VW22		4
1.6 i.e. (160.A1, 160.EC, 160.EB)	55	159 A3.048		10/92-04/95	Q22PR-U	3010	0.8	-	-	VQ22		4
1.6 i.e. (160.AF)	57	159 A3.046		07/90-01/93	Q22PR-U	3010	0.8	-	-	VQ22		4
1.6 SX DGT	66	159A3.000		05/89-10/95	W22EPR-U	3088	0.8	W22TT	-	VW22		4
1.7 D (160.AG)	43/45	149 B4.000		01/88-10/95	DG-001		11V					4
1.8 i.e.	66	835C4.000		09/93-04/95	W20EPR-U	3047	0.8	W20TT	IW20TT	IW20TT		4
1.8 i.e.	81	159 A4.000		10/90-06/93	W20EP-U	3043	0.8	W20TT	IW20TT	IW20TT		4
1.8 i.e. (160.AY)	77	159 A4.046		11/92-06/93	W22EPR-U	3088	0.8	W22TT	-	VW22		4
1.8 i.e. (160.ED)	76	835 C2.000		04/93-04/95	W22EPR-U	3088	0.8	W22TT	-	VW22		4
1.8 i.e. (160.EQ, 160.AM)	74	159 A4.000		10/94-10/95	W20EP-U	3043	0.8	W20TT	IW20TT	IW20TT		4
1.8 i.e. 16V Sport	100	160 A5.000		11/89-06/92	W20EPBR-S	5067	0.85	W20TT	IW20TT	IW20TT		4
1.9 TD (160.AW)	59	160 B6.046		03/92-06/93	DG-001		11V					4
1.9 TD (160.EL, 160.GL, 160.AQ, 160.EI, 160.AR)	66	160 A6.000; 160 A6.046; 160 D1.000		09/90-04/95	DG-001		11V					4
2.0 16V (160.AV)	107	160 A8.046		07/91-04/95	W22EPR-U	3088	0.8	W22TT	-	VW22		4
2.0 i.e. (160.AJ)	80	159 A5.046		06/90-03/92	W22EPR-U	3088	0.8	W22TT	-	VW22		4
2.0 i.e. (160.AT, 160.AJ)	83	159A6.046		03/90-04/95	W22EPR-U	3088	0.8	W22TT	-	VW22		4
2.0 i.e. 16V Sport (160.EF)	102	836 A3.000		03/93-04/95	W22EPR-U	3088	0.8	W22TT	-	VW22		4
ULYSSE (94-02)												
1.8 (220.BB5)	73	LFW		05/97-08/02	K20PR-U	3145	0.8	K20TT	IK20TT	IK20TT		4
1.9 TD (220AH5)	66	DHX (XUD9TF/L)		02/95-08/02	DG-001		11V					4
2.0 (220.AC5)	89	RFU (XU10J2C)		06/94-08/00	K20TXR	5063	1.0	K20TT	IK20TT	IK20TT		4
2.0 16V	100	RFN		09/00-08/02	K16HPR-U11	6076	1.1	KH16TT	IKH16TT	IKH16TT		4
2.0 16V	97	RFV		05/98-09/00	K20TXR	5063	1.0	K20TT	IK20TT	IK20TT		4
2.0 JTD	80	RHZ		10/99-08/02	DG-116		11V					4
2.0 JTD 16V	80	RHW (DW10ATED4)		05/99-08/02	DG-116		11V					4
2.0 Turbo (220.AD5)	108	RGX (XU10J2CTE)		06/94-08/02	K20TXR	5063	1.0	K20TT	IK20TT	IK20TT		4
2.1 TD	80	P8C		03/96-10/99	DG-001		11V					4
ULYSSE (02-11)												
2.0	100	EW10J4(RFN)		08/02-10/05	K20HR-U11	3381	1.1	KH20TT	IKH20TT	IKH20TT		4
2.0 D Multijet	88/100	RHK; RHR	OE: 9651029780	05/06-06/11	DG-116		11V					4
2.0 D Multijet	88/100	RHK; RHR	OE: 9651583680	05/06-06/11	DG-181		11V					4
2.0 JTD	79/80	RHM (DW10ATED4); RHW (DW10ATED4)		08/02-08/06	DG-116		11V					4
2.2 JTD	94	4HW (DW12ATED4)		08/02-05/03	DG-116		11V					4
2.2 JTD	94	4HW (DW12ATED4)		06/03-08/06	DG-181		11V					4
UNO (83-00)												
1.3 Super Diesel	33	127 A5.000; 146 B1.000		06/83-03/92	DG-001		11V					4
1.3 Turbo i.e.	73/74/77	146 A2.000; 146 A2.146; 146 A2.246		04/85-08/89	K22PBR-S	5062	0.85	-	-	VK22		4
1.4 Turbo i.e.	82/87	146 A8.000; 146 A8.046		09/89-12/93	K22PBR-S	5062	0.85	-	-	VK22		4
1.9 D	44	149 B5.046		09/89-03/94	DG-001		11V					4
45 0.9	33	146 A.1000		01/89-12/89	W20EPR-U	3047	0.8	W20TT	IW20TT	IW20TT		4
45 1.0 (146A.ED)	37	156A2.000; 156A2.246		10/89-12/93	K20PR-U	3145	0.8	K20TT	IK20TT	IK20TT		4
45 1.0 (146A.ED)	32	156 A2.048		06/86-12/93	Q20PR-U	3007	0.8	Q20TT	IQ20TT	IQ20TT		4
45 i.e. 1.0	33	156 A2.246		01/92-10/95	Q20PR-U	3007	0.8	Q20TT	IQ20TT	IQ20TT		4
50 1.1	37	156 C.046		01/90-12/93	Q20PR-U	3007	0.8	Q20TT	IQ20TT	IQ20TT		4
50 1.1	37	146 A4.044		01/86-12/89	W20EPR-U	3047	0.8	W20TT	IW20TT	IW20TT		4
50 i.e. 1.1	36	146 C3.000		06/92-12/93	Q20PR-U	3007	0.8	Q20TT	IQ20TT	IQ20TT		4
55 1.0	41	146 C4.011		11/93-08/00	W20EPR-U	3047	0.8	W20TT	IW20TT	IW20TT		4
55 1.1	40	138 B.000		01/83-12/85	W20EPR-U	3047	0.8	W20TT	IW20TT	IW20TT		4
60 1.1	42	160 A3.000		04/89-12/92	Q20PR-U	3007	0.8	Q20TT	IQ20TT	IQ20TT		4
60 1.1 (146A.EG)	43	146 A4.048		05/85-08/89	W20EPR-U	3047	0.8	W20TT	IW20TT	IW20TT		4
60 Diesel 1.7	42/44	146 B2.000; 149 B3.000		07/86-12/93	DG-001		11V					4
70 1.3	48	149 A7.000		05/85-08/89	W20EPR-U	3047	0.8	W20TT	IW20TT	IW20TT		4
70 1.3	50	138B2.000		01/83-04/85	W22EPR-U	3088	0.8	W22TT	-	VW22		4

	KW								QTY		
FIAT <i>continued</i>											
UNO (83-00) <i>continued</i>											
70 i.e. 1.4	51/53	146 C1.000; 160 A1.046		09/89-12/93	W20EPR-U	3047	0.8	W20TT	IW20TT	IW20TT	4
70 S 1.4	52	160 A1.048		09/89-10/92	W20EPR-U	3047	0.8	W20TT	IW20TT	IW20TT	4
70 TD 1.4	52	146 B.000; 146 B3.000		10/86-10/90	DG-001		11V				4
75 i.e. 1.5	55	149 C1.000		10/85-12/93	W22EPR-U	3088	0.8	W22TT	-	VW22	4
X 1/9 (73-89)											
1.3	54/55	128A1.000		05/73-06/78	W20EPR-U	3047	0.8	W20TT	IW20TT	IW20TT	4
1.5	56/63	138A2.000		11/78-12/89	W20EPR-U	3047	0.8	W20TT	IW20TT	IW20TT	4
FORD											
B-MAX (12-)											
1.4	66	RTJC;SPJD		10/12-	T16VR-U10	5086	1.0	TV16TT	ITV16TT	ITV16TT	4
1.5 TDCi	55	UGJC		10/12-	DG-603		5V				4
1.6 TDCi	70	T3JB		10/12-	DG-603		5V				4
CAPRI (78-87)											
1.6	54	LAC(TL16H);LAN(TL16H)		02/79-04/87	MA20P-U	5012	0.9	-	-	-	4
2.0	74	NE3(TL20H);NEN(TL20G)		01/78-12/85	MA20PR-U	5013	0.9	-	-	-	4
C-MAX I (07-)											
1.6	74	HWDA; HWDB; SHDA; SHDB; SHDC		02/07-08/10	T16VR-U10	5086	1.0	TV16TT	ITV16TT	ITV16TT	4
1.6 TDCi	66/74/80	G8DA; G8DB; G8DC; G8DD; GPDA; HHDA; HHDB; MTDA		02/07-	DG-180		11V				4
1.6 TDCi	74	G8DC; MTDA		08/10-	DG-603		5V				4
1.8	92	QQDA; QQDB		02/07-	ZT20EPR11	5087	1.1	T20TT	IT20TT	IT20TT	4
1.8 Flexifuel	92	Q7DA		02/07-08/10	ZT20EPR11	5087	1.1	T20TT	IT20TT	IT20TT	4
1.8 TDCi	85	KKDA		02/07-	DG-121		10V				4
2.0	107	AODA; AODB; AODE; SYDA		02/07-	ZT20EPR11	5087	1.1	T20TT	IT20TT	IT20TT	4
2.0 CNG	107	SYDA		04/09-	ZT20EPR11	5087	1.1	T20TT	IT20TT	IT20TT	4
2.0 LPG	107	SYDA		06/08-	ZT20EPR11	5087	1.1	T20TT	IT20TT	IT20TT	4
2.0 TDCi	81/98/100	G6DA; G6DB; G6DC; G6DD; G6DE; G6DF; G6DG; IXDA		02/07-	DG-181		11V				4
C-MAX II (10-)											
1.5 TDCi	70/88	XWDA; XWDB; XXDA		03/15-	DG-603		5V				4
1.5 TDCi ECOnetic	77	AEDA		03/15-	DG-603		5V				4
1.6 EcoBoost	110/134	JQDA; JQDB; JTDA; JTDB	40000km Lifetime	12/10-	ITV20	5339	1.1	-	ITV20TT	ITV20TT	4
1.6 TDCi	70/85	T1DA; T1DB; T3DA; T3DB; TYDA		12/10-	DG-603		5V				4
1.6 Ti	77/92	IQDA; IQDB; PNDA		12/10-	T16VR-U10	5086	1.0	TV16TT	ITV16TT	ITV16TT	4
2.0 TDCi	85/100/103/110/120/125	T7DB; T8DE; TXDB; TYDA; UFDB; UKDB		02/11-	DG-603		5V				4
COUGAR (98-01)											
2.0 16V	96	EDB(ZH20)		08/98-12/01	T16VR-U10	5086	1.0	TV16TT	ITV16TT	ITV16TT	4
2.5 ST 200	151	MABA		01/00-12/01	PT16EPR-L13	5070	1.3	-	IT16TT	IT16TT	6
2.5 V6 24V	125	LCBA(MP25); LCBE(MP25)		08/98-12/01	PT16EPR-L13	5070	1.3	-	IT16TT	IT16TT	6
ECONOVAN (85-92)											
2.0 D	41	RF		03/86-03/92	DG-114		7V				4
ECOSPORT (13-)											
1.5 TDCi	66	UGJE		10/13-	DG-603		5V				4
ESCORT II (73-81)											
1.1	35	G2		12/74-08/80	W22EP-U	3085	0.8	W22TT	-	VW22	4
1.6 RS	62	L3(KL16G)		12/74-08/80	K20PR-U	3145	0.8	K20TT	IK20TT	IK20TT	4
2.0 RS	80	NE(TL20)		08/75-08/80	MA20P-U	5012	0.9	-	-	-	4
2.0 RS (BATN)	73	NE(TL20)		06/76-02/77	MA20P-U	5012	0.9	-	-	-	4
ESCORT III (80-86)											
1.1	40	GMA		09/80-08/83	Q20PR-U	3007	0.8	Q20TT	IQ20TT	IQ20TT	4
1.1	43	GPA		09/80-08/83	Q22PR-U	3010	0.8	-	-	VQ22	4
1.1	37	GLB; GSE		03/81-02/86	T20EP-U	5031	0.8	T20TT	IT20TT	IT20TT	4
1.3	51	JPA		03/81-02/86	Q20PR-U	3007	0.8	Q20TT	IQ20TT	IQ20TT	4
1.6	48	CHT 1600		05/83-07/86	Q20PR-U	3007	0.8	Q20TT	IQ20TT	IQ20TT	4







Spark & Glow Plugs







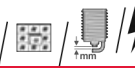

Application Tables





	KW				Standard 			Twin Tip 			QTY
FORD <i>continued</i>											
ESCORT III (80-86) <i>continued</i>											
1.6	58/61/71	LP1; LPA; LUA		09/80-12/85	Q22PR-U	3010	0.8	-	-	VQ22	4
1.6 D	40	LTA		02/84-02/86	DG-123		11V				4
1.6 i	77	LRA		09/83-12/85	Q22PR-U	3010	0.8	-	-	VQ22	4
1.6 i (GAA)	66	L4B		07/85-12/85	Q20PR-U	3007	0.8	Q20TT	IQ20TT	IQ20TT	4
1.6 RS Turbo	97	LNA		11/84-12/85	IQ24	5314	0.8	-	-	-	4
1.6 XR3i	77	LRA		10/82-12/85	Q22P-U	3255	0.8	-	-	VQ22	4
RS 1600i	85	LUE		05/82-07/84	Q22PR-U	3010	0.8	-	-	VQ22	4
ESCORT IV (85-90)											
1.1	37	GSG		12/85-07/90	T20EPR-U	5032	0.8	T20TT	IT20TT	IT20TT	4
1.3	44/46	JBA; JBB; JLA		01/86-07/90	T20EPR-U	5032	0.8	T20TT	IT20TT	IT20TT	4
1.3 (GAF)	46	JBA		07/88-10/90	T20EPR-U	5032	0.8	T20TT	IT20TT	IT20TT	4
1.4	55	FUA		01/86-07/90	Q20PR-U	3007	0.8	Q20TT	IQ20TT	IQ20TT	4
1.4	54	F6B; FUC		01/86-07/90	Q20PR-U11	3008	1.1	Q20TT	IQ20TT	IQ20TT	4
1.4 i	54	FUC		02/86-07/90	Q20PR-U11	3008	1.1	Q20TT	IQ20TT	IQ20TT	4
1.6	60	LUC(HL16)		02/86-07/90	K20PR-U	3145	0.8	K20TT	IK20TT	IK20TT	4
1.6	58/65	LP2; LUG		01/86-07/90	Q20PR-U11	3008	1.1	Q20TT	IQ20TT	IQ20TT	4
1.6 D	40	LTA; LTC		01/86-07/90	DG-123		11V				4
1.6 i	66	L4B		01/86-07/90	Q20PR-U	3007	0.8	Q20TT	IQ20TT	IQ20TT	4
1.6 i	75	LJB		08/89-07/90	Q20PR-U11	3008	1.1	Q20TT	IQ20TT	IQ20TT	4
1.6 Turbo RS	97	LNB		01/86-07/90	Q22PR-U	3010	0.8	-	-	VQ22	4
1.6 XR3i	77	LRB		01/86-07/90	Q22P-U	3255	0.8	-	-	VQ22	4
1.8 D	44	RTA; RTB		07/88-07/90	DG-004		11.5V				4
ESCORT V (90-94)											
1.3	44/46	J6A; JBD		07/90-12/94	T20EPR-U	5032	0.8	T20TT	IT20TT	IT20TT	4
1.4	52	F6G		07/90-12/94	Q20PR-U11	3008	1.1	Q20TT	IQ20TT	IQ20TT	4
1.6	66	LUK		07/90-08/92	Q20PR-U	3007	0.8	Q20TT	IQ20TT	IQ20TT	4
1.6	77	LJF		07/90-12/92	Q20PR-U11	3008	1.1	Q20TT	IQ20TT	IQ20TT	4
1.8 16V	77	RDA		02/92-12/92	PT16VR10	5093	1.0	TV16TT	ITV16TT	ITV16TT	4
1.8 16V XR3i	77/96	RDA; RQB		02/92-12/92	PT16VR10	5093	1.0	TV16TT	ITV16TT	ITV16TT	4
1.8 D	44	RTE; RTF; RTH		07/90-12/94	DG-004		11.5V				4
RS 2000	110	N7A		05/91-12/92	PK22PR11	3265	1.1	-	-	VK22	4
ESCORT VI (92-95)											
1.3	44	J6A		09/92-01/95	T20EPR-U	5032	0.8	T20TT	IT20TT	IT20TT	4
1.4	55	FUH		08/93-01/95	Q20PR-U	3007	0.8	Q20TT	IQ20TT	IQ20TT	4
1.4	52/55	F4B; F6G		08/93-01/95	Q20PR-U11	3008	1.1	Q20TT	IQ20TT	IQ20TT	4
1.4 i	55	F4B		07/93-01/95	Q20PR-U11	3008	1.1	Q20TT	IQ20TT	IQ20TT	4
1.6 16V XR3i	66	L1E		12/92-01/95	PT16VR10	5093	1.0	TV16TT	ITV16TT	ITV16TT	4
1.6 i 16V	65/66	L1E; L1H		09/92-01/95	PT16VR10	5093	1.0	TV16TT	ITV16TT	ITV16TT	4
1.8 16V XR3i	77/96	RDA; RQB		12/92-01/95	PT16VR10	5093	1.0	TV16TT	ITV16TT	ITV16TT	4
1.8 D	44	RTE; RTF; RTH		09/92-01/95	DG-004		11.5V				4
1.8 i 16V	77/96	RDA; RQB		01/93-01/95	PT16VR10	5093	1.0	TV16TT	ITV16TT	ITV16TT	4
1.8 TD	66	RFD; RFK; RFS		02/93-01/95	DG-004		11.5V				4
1.8 XR3i 16V 4x4	77/96	RDA; RQB		08/93-01/95	PT16VR10	5093	1.0	TV16TT	ITV16TT	ITV16TT	4
RS Cosworth 4x4	162	N5F		09/92-12/93	PK20PR-P8	3245	0.8	-	IK20TT	IK20TT	4
ESCORT VII (95-01)											
1.3	44	J6A		01/95-01/99	T20EPR-U	5032	0.8	T20TT	IT20TT	IT20TT	4
1.4	54/55	F4B		01/95-	Q20PR-U11	3008	1.1	Q20TT	IQ20TT	IQ20TT	4
1.6 16V	66	L1E		01/95-07/00	PT16VR10	5093	1.0	TV16TT	ITV16TT	ITV16TT	4
1.6 16V 4x4	66	L1E		01/95-10/98	PT16VR10	5093	1.0	TV16TT	ITV16TT	ITV16TT	4
1.6 16V XR3i	65/66	L1E; L1H		02/95-09/99	PT16VR10	5093	1.0	TV16TT	ITV16TT	ITV16TT	4
1.6 i 16V	65/66	L1E; L1H		01/95-02/99	PT16VR10	5093	1.0	TV16TT	ITV16TT	ITV16TT	4
1.8 16V	77/85	RDA; RKC		01/95-10/98	PT16VR10	5093	1.0	TV16TT	ITV16TT	ITV16TT	4
1.8 16V XR3i	77/85/96	RDA; RKC; RQB		02/95-08/00	PT16VR10	5093	1.0	TV16TT	ITV16TT	ITV16TT	4
1.8 D	44	RTE; RTF; RTH		01/95-	DG-004		11.5V				4
1.8 TD	66	RFD; RFK; RFS		01/95-	DG-004		11.5V				4
1.8 Turbo D	51	RVA		12/95-08/99	DG-007		11.5V				4
RS 2000	110	N7A		02/95-02/98	K20PR-U11	3121	1.1	K20TT	IK20TT	IK20TT	4
RS 2000 4x4	110	N7A(DH20)		02/95-08/96	Q20PR-U11	3008	1.1	Q20TT	IQ20TT	IQ20TT	4
RS Cosworth 4x4	162	N5F		02/95-10/98	PK22PR11	3265	1.1	-	-	VK22	4
FIESTA I (76-86)											
0.9	29/33	TKW; TLA		05/76-08/83	IT20	5326	1.1	-	IT20TT	IT20TT	4
1.0 (WFVT)	29	TKA		10/77-08/83	T20EPR-U	5032	0.8	T20TT	IT20TT	IT20TT	4
1.1	39	GLA		05/76-08/83	IT20	5326	1.1	-	IT20TT	IT20TT	4
1.1 (WFBT)	40	GLW		02/81-08/83	T20EPR-U	5032	0.8	T20TT	IT20TT	IT20TT	4







Spark & Glow Plugs









Application Tables

	KW								QTY	
FORD continued										
FIESTA I (76-86) continued										
1.1 (WFTV)	39	GL1; GLA		10/77-08/83	T20EPR-U	5032 0.8	T20TT	IT20TT	IT20TT	4
1.3	49	J3E		08/77-08/83	Q22PR-U	3010 0.8	-	-	VQ22	4
1.6 XR2	62	L3E		08/81-08/83	Q22PR-U	3010 0.8	-	-	VQ22	4
FIESTA II (83-95)										
1.0	33	TKB; TLB		08/83-11/89	T20EPR-U	5032 0.8	T20TT	IT20TT	IT20TT	4
1.0 (FBD)	33	TKB		09/83-02/89	T20EPR-U	5032 0.8	T20TT	IT20TT	IT20TT	4
1.1 (FBD)	36/37	GSF; GSH		09/83-02/89	T20EPR-U	5032 0.8	T20TT	IT20TT	IT20TT	4
1.4 (FBD)	54	FUD		02/87-02/89	IK20	5304 1.1	-	IK20TT	IK20TT	4
1.4 (FBD)	52	F6C		10/86-02/89	Q20PR-U11	3008 1.1	Q20TT	IQ20TT	IQ20TT	4
1.6 D (FBD)	40	LTB		04/84-02/89	DG-123	11V				4
1.6 XR2 (FBD)	70/71	LUB; LUD		03/84-02/89	Q20PR-U	3007 0.8	Q20TT	IQ20TT	IQ20TT	4
1.8 D (FVJ)	43	RTC; RTD; RTG		03/89-12/95	DG-004	11.5V				4
FIESTA III (89-97)										
1.0	33	TLB		03/89-12/95	T20EPR-U	5032 0.8	T20TT	IT20TT	IT20TT	4
1.1	37/40	G6A; GUE		03/89-12/95	T20EPR-U	5032 0.8	T20TT	IT20TT	IT20TT	4
1.3	44	J6B; JBC		03/89-12/95	T20EPR-U	5032 0.8	T20TT	IT20TT	IT20TT	4
1.3 CAT	44	J6B		05/91-01/97	T20EPR-U	5032 0.8	T20TT	IT20TT	IT20TT	4
1.4	54	FUF		03/89-12/95	K20PR-U	3145 0.8	K20TT	IK20TT	IK20TT	4
1.4	52	F6E		03/89-12/95	Q20PR-U11	3008 1.1	Q20TT	IQ20TT	IQ20TT	4
1.4 CAT	54	F4A		03/89-12/95	Q20PR-U11	3008 1.1	Q20TT	IQ20TT	IQ20TT	4
1.6	66	LUH		03/89-12/92	Q20PR-U	3007 0.8	Q20TT	IQ20TT	IQ20TT	4
1.6 i 16V	65	L1G		01/94-12/95	PT16VR10	5093 1.0	TV16TT	ITV16TT	ITV16TT	4
1.6 Turbo (FBJT)	96	LHA		03/90-10/92	IQ24	5314 0.8	-	-	-	4
1.6 XR2i	76/81	LJC; LJD		03/89-01/94	Q20PR-U11	3008 1.1	Q20TT	IQ20TT	IQ20TT	4
1.8 16V	77	RDB		02/92-12/95	PT16VR10	5093 1.0	TV16TT	ITV16TT	ITV16TT	4
1.8 D	44	RTC; RTD; RTG		03/89-02/96	DG-004	11.5V				4
1.8 XR2i 16V	96	RQC		02/92-12/95	PT16VR10	5093 1.0	TV16TT	ITV16TT	ITV16TT	4
FIESTA IV (95-02)										
1.0 i	38/48	TD(ZL10); ZH10JRB		02/97-01/02	T20EPR-U	5032 0.8	T20TT	IT20TT	IT20TT	4
1.25 i 16V	55	DHA; DHB; DHC; DHD; DHE; DHF; DHG		08/95-01/02	PT16VR10	5093 1.0	TV16TT	ITV16TT	ITV16TT	4
1.3	42/44	J4C		02/96-08/03	T20EPR-U	5032 0.8	T20TT	IT20TT	IT20TT	4
1.3 i	37/44	J4C; J4J; J4L; J4Q; J4R; J4T; JBC; JJA; JJC; JJE; JJJ; JJK; JJM		08/95-01/02	PT16EPR-L13	5070 1.3	-	IT16TT	IT16TT	4
1.3 i	44	J4C		04/96-08/99	T20EPR-U	5032 0.8	T20TT	IT20TT	IT20TT	4
1.4 i	66	FHA		04/96-10/99	PT16VR10	5093 1.0	TV16TT	ITV16TT	ITV16TT	4
1.4 i 16V	66	FHA		04/96-01/02	PT16VR10	5093 1.0	TV16TT	ITV16TT	ITV16TT	4
1.6 16V Sport	76	L1V		02/00-01/02	PT16VR10	5093 1.0	TV16TT	ITV16TT	ITV16TT	4
1.8 D	44	RTJ; RTK		08/95-	DG-007	11.5V				4
1.8 DI	55	RTN; RTP; RTQ		04/00-	DG-007	11.5V				4
D 1.8	44	RTJ; RTK		05/98-	DG-007	11.5V				4
TD 1.8	55	RTN; RTP; RTQ		03/00-	DG-121	10V				4
FIESTA V (01-08)										
1.25 16V	51/55	FUJA; FUJB; M7JA; M7JB		05/02-06/08	T16VR-U10	5086 1.0	TV16TT	ITV16TT	ITV16TT	4
1.3	44/51	A9JA; A9JB; BAJA		11/01-06/08	T16VR-U10	5086 1.0	TV16TT	ITV16TT	ITV16TT	4
1.4 16V	59	FXJA; FXJB		11/01-06/08	T16VR-U10	5086 1.0	TV16TT	ITV16TT	ITV16TT	4
1.4 TDCi	50	F6JA; F6JB		11/01-11/04	DG-113	11V				4
1.4 TDCi	50	F6JA; F6JB		11/04-	DG-180	11V				4
1.6 16V	74	FYJA; FYJB		11/01-06/08	T16VR-U10	5086 1.0	TV16TT	ITV16TT	ITV16TT	4
1.6 TDCi	66	HHJA		11/04-06/07	DG-113	11V				4
1.6 TDCi	66	HHJB		06/07-06/08	DG-180	11V				4
ST150	110	N4JB		03/05-06/08	VT20	5638 1.1	-	IT20TT	IT20TT	4
FIESTA VI (08-)										
1.25	44/60	SNJA; SNJB; STJA; STJB		06/08-	T16VR-U10	5086 1.0	TV16TT	ITV16TT	ITV16TT	4
1.4	71	SPJA; SPJC		06/10-	ITV22	5340 0.8	-	-	-	4
1.4	71	SPJA; SPJC		06/08-06/10	T16VR-U10	5086 1.0	TV16TT	ITV16TT	ITV16TT	4
1.4 LPG	71	RTJA; RTJB	40000km Lifetime	01/09-03/10	ITV20	5339 1.1	-	ITV20TT	ITV20TT	4
1.4 TDCi	50/51	F6JB; F6JD; KVJA		01/09-	DG-180	11V				4
1.5 TDCi	55	UGJC		09/12-	DG-603	5V				4
1.6 TDCi	55/66/70	HHJC; HHJD; HHJE; HHJF; T3JA; TZJA; TZJB; UBJA		06/08-	DG-180	11V				4

	KW					 Standard				QTY	
FORD continued											
FOCUS C-MAX (03-07)											
1.6	74	HWDA/B(ZETEC16-100)		10/03-03/07	T16VR-U10	5086	1.0	TV16TT	ITV16TT	ITV16TT	4
1.6 TDCi	66/80	G8DA; G8DB; HHDA; HHDB		10/03-02/06	DG-113		11V				4
1.6 TDCi	66/80	G8DA; G8DB; HHDA; HHDB		02/06-03/07	DG-180		11V				4
1.6 Ti	85	HXDA(ZH16TIVCT)		08/04-03/07	T16VR-U10	5086	1.0	TV16TT	ITV16TT	ITV16TT	4
1.8	92	Q7DA; QQDA; QQDB		04/04-08/05	VT20	5638	1.1	-	IT20TT	IT20TT	4
1.8	92	Q7DA; QQDA; QQDB		09/05-03/07	ZT20EPR11	5087	1.1	T20TT	IT20TT	IT20TT	4
1.8	88	CSDA(Duratec HE 120)	OEM Optional	10/03-03/04	VT20	5638	1.1	-	IT20TT	IT20TT	4
1.8 Flexifuel	92	Q7DA		01/06-03/07	ZT20EPR11	5087	1.1	T20TT	IT20TT	IT20TT	4
1.8 TDCi	85	KKDA		01/05-03/07	DG-121		10V				4
2.0	107	AODA; AODB; SYDA		03/04-03/07	ZT20EPR11	5087	1.1	T20TT	IT20TT	IT20TT	4
2.0 TDCi	98/100	G6DA; G6DB; G6DC; G6DD; G6DE; G6DF; G6DG		10/03-03/07	DG-181		11V				4
FOCUS I (98-05)											
1.4 16V	55	FXDA(ZH14SE);FXDA(ZH14SE) - E6; FXDC(ZH14SED4)		10/98-11/04	T16VR-U10	5086	1.0	TV16TT	ITV16TT	ITV16TT	4
1.6 16V	74	FYDA;FYDC		10/98-11/04	T16VR-U10	5086	1.0	TV16TT	ITV16TT	ITV16TT	4
1.8 16V	85	EYDA(ZH18E);EYDA(ZH18E) - E6; EYDC(ZH18ED4)		10/98-11/04	T16VR-U10	5086	1.0	TV16TT	ITV16TT	ITV16TT	4
1.8 16V	85	ZH18(GPL)	Flexible fuel	11/01-11/04	VT20	5638	1.1	-	IT20TT	IT20TT	4
1.8 BiFuel	82	ZH18(GPL)	Flexible fuel	02/03-01/05	VT20	5638	1.1	-	IT20TT	IT20TT	4
1.8 DI / TDDi	55	BHDA; BHDB		08/99-11/04	DG-101		11V				4
1.8 DI / TDDi	55	BHDA; BHDB		08/99-11/04	DG-121		10V				4
1.8 TDCi	74/85	F9DA; F9DB; FFDA		03/01-11/04	DG-121		10V				4
1.8 Turbo DI / TDDi	55/66	BHDA; BHDB; C9DA; C9DB; C9DC		10/98-03/05	DG-121		10V				4
2.0 16V	96	EDDB; EDDC; EDDD; EDDF		10/98-11/04	T16VR-U10	5086	1.0	TV16TT	ITV16TT	ITV16TT	4
RS	158	HMDA		10/02-11/04	PT16VR13	5068	1.3	TV16TT	ITV16TT	ITV16TT	4
ST170	127	ALDA		03/02-11/04	ITV24	5341	0.8	-	-	-	4
FOCUS II (04-)											
1.4	59	FXJA/FXJB		11/04-04/10	T16VR-U10	5086	1.0	TV16TT	ITV16TT	ITV16TT	4
1.6	74	FYJA/FYJB;HWDA/B(ZETEC16-100)		04/05-	T16VR-U10	5086	1.0	TV16TT	ITV16TT	ITV16TT	4
1.6 TDCi	66/74/80	G8DA; G8DB; G8DC; G8DD; G8DE; G8DF; GPDA; GPDB; GPDC; HHDA; HHDB; MTDA		11/04-02/06	DG-113		11V				4
1.6 TDCi	66/74/80/81	G8DA; G8DB; G8DC; G8DD; G8DE; G8DF; GPDA; GPDB; GPDC; HHDA; HHDB; MTDA		02/06-	DG-180		11V				4
1.6 Ti	85	HXDA(ZH16TIVCT)		11/04-04/10	T16VR-U10	5086	1.0	TV16TT	ITV16TT	ITV16TT	4
1.8	92	Q7DA; QQDB		03/06-08/10	ZT20EPR11	5087	1.1	T20TT	IT20TT	IT20TT	4
1.8 Flexifuel	92	Q7DA		01/06-12/07	VT20	5638	1.1	-	IT20TT	IT20TT	4
1.8 Flexifuel	92	Q7DA		12/07-08/10	ZT20EPR11	5087	1.1	T20TT	IT20TT	IT20TT	4
1.8 Flexifuel	92/96	DURA18CNG(125); Q7DA(DURA18FLEX)	Flexible fuel	12/05-12/07	VT20	5638	1.1	-	IT20TT	IT20TT	4
1.8 TDCi	85	KKDA; KKDB		11/04-	DG-121		10V				4
2.0	104/105/107	AODA; AODB		11/04-	ZT20EPR11	5087	1.1	T20TT	IT20TT	IT20TT	4
2.0 CNG	107	SYDA		04/09-	ZT20EPR11	5087	1.1	T20TT	IT20TT	IT20TT	4
2.0 LPG	107	SYDA		06/08-	ZT20EPR11	5087	1.1	T20TT	IT20TT	IT20TT	4
2.0 TDCi	81/98/100	G6DA; G6DB; G6DD; G6DE; G6DF; IXDA		11/04-	DG-181		11V				4
2.5 RS	224	JZDA		01/09-08/10	IKH22	5345	0.8	-	-	VKH22	5
2.5 RS 500	257	JZDA		05/10-	IKH24	5346	0.8	-	-	-	5
2.5 ST	166	HYDA		10/05-12/07	IKH22	5345	0.8	-	-	VKH22	5
FOCUS III (11-)											
1.5 TDCi	70/88	XWDA; XWDB; XWDC; XWDD; XXDA; XXDC		09/14-	DG-603		5V				4
1.5 TDCi ECONetic	77	XXDB		09/14-	DG-603		5V				4









	KW					Standard				QTY	
FORD continued											
FOCUS III (11-) continued											
1.6 EcoBoost	110/134	JQDA; JQDB; JTDA; JTDB; YUDA	40000km Lifetime	04/11-	ITV20	5339	1.1	-	ITV20TT	ITV20TT	4
1.6 Flexifuel	88	MUDA		04/11-	T16VR-U10	5086	1.0	TV16TT	ITV16TT	ITV16TT	4
1.6 LPG	88	MUDA		02/12-	T16VR-U10	5086	1.0	TV16TT	ITV16TT	ITV16TT	4
1.6 TDCi	70/85	T1DA; T1DB; T3DA; T3DB		04/11-	DG-603		5V				4
1.6 TDCi ECOnetic	77	NGDA; NGDB		05/12-	DG-603		5V				4
1.6 Ti	63/77/92	IQDB; PNDA; XTDA		05/11-	T16VR-U10	5086	1.0	TV16TT	ITV16TT	ITV16TT	4
2.0 TDCi	85/100/103/110/120/136	T7DB; T8DA; TXDB; TYDA; UFDB; UKDB		04/11-	DG-603		5V				4
FUSION (02-)											
1.25	55	FUJA; FUJB		08/04-	T16VR-U10	5086	1.0	TV16TT	ITV16TT	ITV16TT	4
1.4	59	FXJA; FXJB; FXJC		08/02-	T16VR-U10	5086	1.0	TV16TT	ITV16TT	ITV16TT	4
1.4 LPG	59	UTJA	40000km Lifetime	01/10-	ITV20	5339	1.1	-	ITV20TT	ITV20TT	4
1.4 TDCi	50	F6JA		08/02-11/04	DG-113		11V				4
1.4 TDCi	50	F6JB		11/04-	DG-180		11V				4
1.6	74	FYJA; FYJB; FYJC		08/02-	T16VR-U10	5086	1.0	TV16TT	ITV16TT	ITV16TT	4
1.6 TDCi	66	HHJA		11/04-06/07	DG-113		11V				4
1.6 TDCi	66	HHJB		06/07-	DG-180		11V				4
GALAXY (95-06)											
1.9 TDI	66/81/85	1Z; AFN; AHU; ANU; AUY; AVG		03/95-10/01	DG-005		11V				4
1.9 TDI	66/85/96/110	1Z; AHU; ANU; ASZ; AUY; BTB		02/03-05/06	DG-109		11V				4
2.0 i	85	NSE; ZVSA		11/95-12/00	IK20	5304	1.1	-	IK20TT	IK20TT	4
2.0 i	85	NSE; ZVSA		01/01-05/06	PK22PR-L11S	3284	1.1	-	-	VK22G	4
2.3 16V	103	E5SB		09/01-05/06	IK20	5304	1.1	-	IK20TT	IK20TT	4
2.3 16V	107	Y5(DH23)		01/97-03/00	VK20	5604	1.1	-	IK20TT	IK20TT	4
2.8 i V6	128	AAA; AMY		11/95-04/00	K20TXR	5063	1.0	K20TT	IK20TT	IK20TT	6
2.8 i V6 4x4	128	AAA; AMY		04/96-04/00	K20TXR	5063	1.0	K20TT	IK20TT	IK20TT	6
2.8 V6	150	AYL		04/00-05/06	PKJ16CR-L11	3246	1.1	-	IK16TT	IK16TT	6
GALAXY (06-)											
1.6 EcoBoost	118	JTWA; JTWB	40000km Lifetime	02/11-	ITV20	5339	1.1	-	ITV20TT	ITV20TT	4
1.6 TDCi	85	T1WA; T1WB		02/11-	DG-603		5V				4
1.8 TDCi	74/92	FFWA; QYWA		05/06-	DG-121		10V				4
2.0	107	AOWA; AOWB		05/06-	ZT20EPR11	5087	1.1	T20TT	IT20TT	IT20TT	4
2.0 EcoBoost	149	TNWA	40000km Lifetime	03/10-	ITV22	5340	0.8	-	-	-	4
2.0 Flexifuel	107	TBWA; TBWB		05/06-	ZT20EPR11	5087	1.1	T20TT	IT20TT	IT20TT	4
2.0 TDCi	85/96/100/103	AZWA; AZWC; KLWA; QXWA; QXWB; QXWC; TYWA		05/06-	DG-181		11V				4
2.0 TDCi	100/103/120	TXWA; UFWA; UKWA		05/06-	DG-603		5V				4
2.2 TDCi	129/147	KNWA; Q4BA; Q4WA		03/08-	DG-614		11V				4
2.3	118	SEWA		07/07-04/10	ITV16	5338	1.1	-	ITV16TT	ITV16TT	4
GALAXY (15-)											
2.0 TDCi	88/110/132	T7CI; T7CJ; T7CK; T7CL; T8CG; T8CH; T8CI; T8CJ; UFCA; UFCB		04/15-	DG-603		5V				4
2.0 TDCi Bi-Turbo	154	T9CB; T9CC		04/15-	DG-603		5V				4
GRANADA (72-85)											
1.9 D	40			08/77-08/82	DG-001		11V				4
2.0	74/77	NC; NE/NS; NEK		08/79-08/85	MA20PR-U	5013	0.9	-	-	-	4
2.0	66	NYP		08/77-08/85	W22EPR-U	3088	0.8	W22TT	-	VW22	6
2.1 D	46	WTA		08/77-08/82	DG-001		11V				4
2.3	79/82/84	YYH; YYP; YYU		01/72-08/85	W20EPR-U	3047	0.8	W20TT	IW20TT	IW20TT	6
2.5 D	51	STP		08/82-08/85	DG-001		11V				4







	KW					Standard			Twin Tip				QTY	
FORD <i>continued</i>														
GRANADA (72-85) <i>continued</i>														
2.8 i	108/110	PRC; PRD		08/77-08/85	W22EPR-U	3088	0.8	W22TT	-	WV22				6
GRAND C-MAX (10-)														
1.5 TDCi	70/88	XWDA; XWDB; XXDA; XXDC		03/15-	DG-603		5V							4
1.6 EcoBoost	110/134	JQDA; JQDB; JTDA; JTDB	40000km Lifetime	12/10-	ITV20	5339	1.1	-	ITV20TT	ITV20TT				4
1.6 TDCi	70/85	T1DA; T1DB; T3DA; T3DB		12/10-	DG-603		5V							4
1.6 Ti	77/92	DC TI-VCT(C16HDEZ)		12/10-	T16VR-U10	5086	1.0	TV16TT	ITV16TT	ITV16TT				4
2.0 TDCi	85/100/103/110/120/125	T7DB; T8DE; TXDB; TYDA; UFDB; UKDB		02/11-	DG-603		5V							4
GT (03-)														
5.4	368			08/06-	IT20	5326	1.1	-	IT20TT	IT20TT				8
KA (96-08)														
1.0 i	38/48	ZH10JRB		07/97-11/08	T16EPR-U	5022	0.8	T16TT	IT16TT	IT16TT				4
1.3 i	36/37/44	J4 D/K/M/N/P/S;Endura E SEFI; JJB; JJD; JJF; JJG; JJH; JJJ		09/96-11/08	T16EPR-U	5022	0.8	T16TT	IT16TT	IT16TT				4
1.3 i	44/51	A9B; BAA(BL13EFIN);BAJ A(DURA13-60); BAA; J4N(BL13EFIN), J4P(BL13EFIN), J4S(BL13EFIN)		05/02-11/08	T16VR-U10	5086	1.0	TV16TT	ITV16TT	ITV16TT				4
1.6 i	70	CDC		07/03-11/08	T16VR-U10	5086	1.0	TV16TT	ITV16TT	ITV16TT				4
KA (08-)														
1.2	51	FP4		10/08-	XU22EPR-U	3179	0.9	XU22TT	-	VXU22				4
1.3 TDCi	55	FD4		10/08-	DG-171		11V							4
KUGA I (08-)														
2.0 TDCi	100/103	G6DG; UFDA		03/08-	DG-181		11V							4
2.0 TDCi 4x4	100/103/120	G6DG; TXDA; UFDA		03/08-	DG-181		11V							4
2.5	147	HYDB; HYDC		03/09-	IKH20	5344	1.1	-	IKH20TT	IKH20TT				5
2.5 4x4	147	HYDB		03/09-	IKH20	5344	1.1	-	IKH20TT	IKH20TT				5
KUGA II (13-)														
1.6 EcoBoost	110	JQMA; JQMB	40000km Lifetime	03/13-	ITV20	5339	1.1	-	ITV20TT	ITV20TT				4
1.6 EcoBoost 4x4	134	JTMA	40000km Lifetime	03/13-	ITV20	5339	1.1	-	ITV20TT	ITV20TT				4
2.0 TDCi	88/100/103/110	T7MA; T7MB; UFMA; UKMA; XRMA; XRMB		03/13-	DG-603		5V							4
2.0 TDCi 4x4	100/103/110/120/132	T7MA; T7MB; T8MA; T8MB; TXDA; TXMA; UFMA; UKMA		03/13-	DG-603		5V							4
MAVERICK (93-98)														
2.4 i	87/91	KA-24; KA24-E		02/93-04/98	K16GPR-U11	3135	1.1	-	-	-				4
2.4 i (UDS)	85	KA-24		09/96-04/98	K16GPR-U11	3135	1.1	-	-	-				4
2.7 TD	74/92	TD27; TD27E		02/93-04/98	DG-137		11V							4
MAVERICK (01-)														
2.0 16V	91	YF		02/01-	PT16VR13	5068	1.3	TV16TT	ITV16TT	ITV16TT				4
2.3 16V	110	GZ		03/04-	ZT20EPR11	5087	1.1	T20TT	IT20TT	IT20TT				4
3.0 V6 24V	145/149	AJ		02/01-	IT20	5326	1.1	-	IT20TT	IT20TT				6
MONDEO I (93-96)														
1.6 i 16V	65/66	L1F; L1J		04/93-08/96	PT16VR10	5093	1.0	TV16TT	ITV16TT	ITV16TT				4
1.8 i 16V	82/85	RKA; RKB		04/93-08/96	PT16VR10	5093	1.0	TV16TT	ITV16TT	ITV16TT				4
1.8 i 16V 4x4	85	RKA		02/93-08/96	PT16VR10	5093	1.0	TV16TT	ITV16TT	ITV16TT				4
1.8 TD	65/66	RFM; RFN		06/93-08/96	DG-004		11.5V							4
2.0 i 16V	97/100	NGA		01/93-08/96	PT16VR10	5093	1.0	TV16TT	ITV16TT	ITV16TT				4
2.0 i 16V	97	NGA		12/94-08/96	PT16VR13	5068	1.3	TV16TT	ITV16TT	ITV16TT				4
2.0 i 16V 4x4	97/100	NGA		04/93-08/96	PT16VR10	5093	1.0	TV16TT	ITV16TT	ITV16TT				4
2.5 i 24V	125	SEA		07/94-08/96	PT16EPR-L13	5070	1.3	-	IT16TT	IT16TT				6

	KW					Standard			Twin Tip			QTY
FORD continued												
MONDEO II (96-00)												
1.6 i	66	L1J		09/96-11/00	PT16VR10	5093	1.0	TV16TT	ITV16TT	ITV16TT		4
1.6 i 16V	70	L1L; L1N; L1Q		05/98-11/00	PT16VR10	5093	1.0	TV16TT	ITV16TT	ITV16TT		4
1.8 i	85	RKB		09/96-11/00	PT16VR10	5093	1.0	TV16TT	ITV16TT	ITV16TT		4
1.8 TD	66	RFN		09/96-11/00	DG-007		11.5V					4
2.0 i	96	NGA		09/96-11/00	PT16VR10	5093	1.0	TV16TT	ITV16TT	ITV16TT		4
2.5 24V	125	SEA; SEC		09/96-11/00	PT16EPR-L13	5070	1.3	-	IT16TT	IT16TT		6
2.5 ST 200	151	SGA		05/99-11/00	PT16EPR-L13	5070	1.3	-	IT16TT	IT16TT		6
MONDEO III (00-07)												
1.8 16V	81/92	CGBA; CGBB; CHBA; CHBB		11/00-08/07	ZT20EPR11	5087	1.1	T20TT	IT20TT	IT20TT		4
1.8 SCi	96	CFBA		06/03-08/07	ZT20EPR11	5087	1.1	T20TT	IT20TT	IT20TT		4
2.0 16V	107	CJBA; CJBB		09/05-08/07	VT20	5638	1.1	-	IT20TT	IT20TT		4
2.0 16V	107	CJBA; CJBB		11/00-09/05	ZT20EPR11	5087	1.1	T20TT	IT20TT	IT20TT		4
2.0 16V DI / TDDi / TDCi	66	D5BA; SDBA		11/00-08/07	DG-130		11.5V					4
2.0 16V TDDi / TDCi	85	D6BA; HJBA; HJBB; HJBC		11/00-08/07	DG-130		11.5V					4
2.0 TDCi	96	FMBA; N7BA		10/01-08/07	DG-130		11.5V					4
2.2 TDCi	110/114	QJBA; QJBB; QJBC; QJBD		09/04-08/07	DG-130		11.5V					4
2.5 V6 24V	125	LCBD		11/00-04/05	PT16EPR-L13	5070	1.3	-	IT16TT	IT16TT		6
3.0 V6 24V	150	DURA30(204)		09/04-04/05	PT16EPR-L13	5070	1.3	-	IT16TT	IT16TT		6
ST220	166	MEBA		04/02-08/07	ZT20EPR11	5087	1.1	T20TT	IT20TT	IT20TT		6
MONDEO IV (07-)												
1.6 EcoBoost	118	JTBA; JTBB	40000km Lifetime	02/11-	ITV20	5339	1.1	-	ITV20TT	ITV20TT		4
1.6 TDCi	85	T1BA; T1BB; T1BC		12/10-	DG-603		5V					4
1.6 Ti	81/88/92	C16HDEZ; PNBA; RHBA		03/07-09/10	T16VR-U10	5086	1.0	TV16TT	ITV16TT	ITV16TT		4
1.8 TDCi	74/92	FFBA; KHBA; QYBA		03/07-	DG-121		10V					4
2.0	107	AOBA; AOBC; TBBA		03/07-09/10	ZT20EPR11	5087	1.1	T20TT	IT20TT	IT20TT		4
2.0 EcoBoost	176	TPBA	40000km Lifetime	07/10-	ITV22	5340	0.8	-	-	-		4
2.0 Flexifuel	107	TBBA; TBBA		03/09-	ZT20EPR11	5087	1.1	T20TT	IT20TT	IT20TT		4
2.0 LPG	107	TBBA		07/09-	VT20	5638	1.1	-	IT20TT	IT20TT		4
2.0 SCTi	149	TNBA	40000km Lifetime	03/10-	ITV22	5340	0.8	-	-	-		4
2.0 TDCi	85/96/100/103	AZBA; AZBC; KLBA; LPBA; QXBA; QXBB		03/07-	DG-181		11V					4
2.0 TDCi	85/100/103/120	TXBA; TXBB; TYBA; UFBA; UKBA		03/07-	DG-603		5V					4
2.2 TDCi	147	KNBA		07/10-	DG-603		5V					4
2.2 TDCi	129	Q4BA		03/08-04/10	DG-614		11V					4
2.3	118	SEBA		07/07-03/10	ITV16	5338	1.1	-	ITV16TT	ITV16TT		4
2.5	162	HUBA		03/07-03/10	IKH22	5345	0.8	-	-	VKH22		5
2.5	162	HUBA		03/07-03/10	VKH20Y	5639	0.8	-	-	VKH20Y		5
MONDEO V (14-)												
1.5 TDCi	88	UGCC; XUCA		03/15-	DG-603		5V					4
1.6 TDCi	85	NGCA; U3CA		09/14-	DG-603		5V					4
2.0 TDCi	110/132	T7CE; T8CC		09/14-	DG-603		5V					4
2.0 TDCi 4x4	110/132	T7CE; T8CC		02/15-	DG-603		5V					4
2.0 TDCi Bi-Turbo	155	T9CA		03/15-	DG-603		5V					4
ORION I (83-86)												
1.3	51	JPA		07/83-03/86	Q20PR-U	3007	0.8	Q20TT	IQ20TT	IQ20TT		4
1.6	58	LPA		07/83-03/86	Q22PR-U	3010	0.8	-	-	VQ22		4
1.6 D	40	LTA		02/84-03/86	DG-123		11V					4
1.6 i	77	LRA		07/83-03/86	Q22P-U	3255	0.8	-	-	VQ22		4
ORION II (85-90)												
1.3	44/51	JBB; JP		12/85-07/90	T20EPR-U	5032	0.8	T20TT	IT20TT	IT20TT		4
1.4	55	FUA		12/85-07/90	Q20PR-U	3007	0.8	Q20TT	IQ20TT	IQ20TT		4
1.4	54	FUC		01/86-07/90	Q20PR-U11	3008	1.1	Q20TT	IQ20TT	IQ20TT		4
1.4	52	FUAA		03/86-07/90	VK20	5604	1.1	-	IK20TT	IK20TT		4
1.4 CAT	54	F6D		02/87-07/90	Q20PR-U11	3008	1.1	Q20TT	IQ20TT	IQ20TT		4
1.6	66	LUC		12/85-07/90	Q20PR-U	3007	0.8	Q20TT	IQ20TT	IQ20TT		4
1.6 D	40	LTC		12/85-01/89	DG-123		11V					4
1.6 i	77	LRB		03/86-07/90	Q22PR-U	3010	0.8	-	-	VQ22		4

Spark & Glow Plugs







Application Tables









	KW								QTY		
FORD <i>continued</i>											
ORION II (85-90) <i>continued</i>											
1.6 i CAT	66	L4B		03/86-07/90	Q20PR-U	3007	0.8	Q20TT	IQ20TT	IQ20TT	4
1.8 D	44	RTA; RTB		01/89-07/90	DG-004		11.5V				4
ORION III (90-93)											
1.3	44	J6A		07/90-12/93	T20EPR-U	5032	0.8	T20TT	IT20TT	IT20TT	4
1.4	54	FUH		07/90-12/93	K20PR-U	3145	0.8	K20TT	IK20TT	IK20TT	4
1.4	52	F6G		07/90-12/93	Q20PR-U11	3008	1.1	Q20TT	IQ20TT	IQ20TT	4
1.6	66	LUK		07/90-12/92	Q20PR-U	3007	0.8	Q20TT	IQ20TT	IQ20TT	4
1.6 i	77	LJF		07/90-09/92	Q20PR-U11	3008	1.1	Q20TT	IQ20TT	IQ20TT	4
1.6 i 16V	66	L1E		07/92-12/93	PT16VR10	5093	1.0	TV16TT	ITV16TT	ITV16TT	4
1.8 D	44	RTE; RTF; RTH		11/90-12/93	DG-004		11.5V				4
1.8 i 16V	77/96	RDA; RQB		01/92-12/93	PT16VR10	5093	1.0	TV16TT	ITV16TT	ITV16TT	4
1.8 TD	66	RFD; RFK		03/92-12/93	DG-004		11.5V				4
P 100 (87-92)											
1.8 TD	55	RFA		10/87-12/92	DG-004		11.5V				4
2.0	57	NAE		10/87-12/92	T16VR-U10	5086	1.0	TV16TT	ITV16TT	ITV16TT	4
PUMA (97-02)											
1.4 16V	66	FHD(ZH14S);FHF(ZH14S)		11/97-10/00	T16VR-U10	5086	1.0	TV16TT	ITV16TT	ITV16TT	4
1.6 16V	76	ZH16S		08/00-12/01	T16VR-U10	5086	1.0	TV16TT	ITV16TT	ITV16TT	4
1.7 16V	92	MHA(ZH17)		03/97-12/01	PT16VR13	5068	1.3	TV16TT	ITV16TT	ITV16TT	4
ST 160	118	MHA-160(ZH17)		06/99-10/00	PT16VR13	5068	1.3	TV16TT	ITV16TT	ITV16TT	4
RANGER (99-06)											
2.5 D	57	WL		10/99-04/02	DG-146		11V				4
2.5 D 4x4	57	WL		10/99-04/02	DG-146		11V				4
2.5 TD	62	WL-T		04/02-06/06	DG-311		11V				4
2.5 TD 4x4	80	WL-T		10/99-06/06	DG-146		11V				4
2.5 TD 4x4	62	WL-T		04/02-06/06	DG-311		11V				4
RANGER (06-)											
2.5 TDCi 4x4	105	WLAA		05/06-	DG-146		11V				4
SCORPIO I (85-94)											
1.8	66	REC(TL18)		04/85-08/88	MA20P-U	5012	0.9	-	-	-	4
2.0	77	NEL(TL20H)		04/85-08/89	MA20PR-U	5013	0.9	-	-	-	4
2.0	80	N8A; N8B		11/88-03/93	Q20PR-U	3007	0.8	Q20TT	IQ20TT	IQ20TT	4
2.0 i	92	N9B(DL20EFI)		05/89-02/92	K20PR-U	3145	0.8	K20TT	IK20TT	IK20TT	4
2.0 i	85	NRI		04/85-09/94	MA20PR-U	5013	0.9	-	-	-	4
2.0 i	74	NRC		10/85-12/90	MA20P-U	5012	0.9	-	-	-	4
2.0 i	85/88	N9D; N9F		09/91-09/94	Q20PR-U	3007	0.8	Q20TT	IQ20TT	IQ20TT	4
2.4 i	96	ARC		09/86-09/88	Q20PR-U	3007	0.8	Q20TT	IQ20TT	IQ20TT	6
2.4 i	92	ARD		10/88-10/94	T20EPR-U	5032	0.8	T20TT	IT20TT	IT20TT	6
2.4 i CAT	92	ARD		10/88-09/94	T20EPR-U	5032	0.8	T20TT	IT20TT	IT20TT	6
2.5 D	51	STR		12/85-12/94	DG-001		11V				4
2.5 TD	68/85	SCB; SFA; SFB		06/88-09/94	DG-001		11V				4
2.8 i	110	PRE		04/85-11/86	W22EPR-U	3088	0.8	W22TT	-	VW22	6
2.8 i 4x4	110	PRE		10/85-11/86	W22EPR-U	3088	0.8	W22TT	-	VW22	6
2.9 24V	143	BOA		08/93-09/94	PK20PR11	3168	1.1	K20TT	IK20TT	IK20TT	6
2.9 i	110	BRC		09/86-09/94	Q20PR-U	3007	0.8	Q20TT	IQ20TT	IQ20TT	6
2.9 i	107	BRD		09/86-09/94	T16EPR-U	5022	0.8	T16TT	IT16TT	IT16TT	6
2.9 i 24V	143	BOA		04/91-09/94	PK20PR11	3168	1.1	K20TT	IK20TT	IK20TT	6
2.9 i 4x4	110	BRC		09/86-09/94	Q20PR-U	3007	0.8	Q20TT	IQ20TT	IQ20TT	6
2.9 i 4x4	107	BRD		05/88-10/94	T16EPR-U	5022	0.8	T16TT	IT16TT	IT16TT	6
2.9 i CAT	107	BRE		10/87-09/94	T16EPR-U	5022	0.8	T16TT	IT16TT	IT16TT	6
SCORPIO II (94-98)											
2.0 i	85	NSD		10/94-08/98	PK20PR11	3168	1.1	K20TT	IK20TT	IK20TT	4
2.0 i 16V	100	N3A		10/94-08/98	PK20PR11	3168	1.1	K20TT	IK20TT	IK20TT	4
2.3 i 16V	108	Y5A		06/96-08/98	IK20	5304	1.1	-	IK20TT	IK20TT	4
2.3 i 16V	108	Y5A(DH23)		06/96-08/98	VK20	5604	1.1	-	IK20TT	IK20TT	4
2.5 TD	85/92	SCC; VM		10/94-08/98	DG-109		11V				4
2.9 i	110	BRG		02/95-08/98	Q20PR-U11	3008	1.1	Q20TT	IQ20TT	IQ20TT	6
2.9 i 24V	152	BOB		10/94-08/98	PK20PR11	3168	1.1	K20TT	IK20TT	IK20TT	6
SIERRA (82-87)											
1.3	44	JCT		08/82-01/85	MA20P-U	5012	0.9	-	-	-	4
1.6	55	LCS		08/82-12/86	MA20PR-U	5013	0.9	-	-	-	4
1.6	55/58	LCT;LSD(TL16); LPA; LSE(TL16)		08/82-12/86	MA20P-U	5012	0.9	-	-	-	4
1.8	66	REB(TL18);RED(TL18); REB(TL18)		10/84-12/86	MA20P-U	5012	0.9	-	-	-	4
2.0	74/77	NET; NRD		08/82-12/86	MA20PR-U	5013	0.9	-	-	-	4
2.0	85	NRB(TL20INJ)		03/85-12/86	MA20P-U	5012	0.9	-	-	-	4

	KW					Standard		Twin Tip		QTY	
FORD <i>continued</i>											
SIERRA (82-87) <i>continued</i>											
2.0	74	NRD		10/85-12/86	W20EXR-U	3066	0.8	W20TT	IW20TT	IW20TT	4
2.0	66	NYT		08/82-10/84	W22EPR-U	3088	0.8	W22TT	-	VW22	6
2.0 i	85	NRB(TL20INJ)		03/85-12/86	MA20P-U	5012	0.9	-	-	-	4
2.3	84	YYT		08/82-12/86	W22EPR-U	3088	0.8	W22TT	-	VW22	6
2.3 D	49	YTT		08/82-12/86	DG-001		11V				4
2.8 i 4x4	105	PR6		08/82-12/86	W22EPR-U	3088	0.8	W22TT	-	VW22	6
2.8 i 4x4	107	PR7(TV28EFI);PRT		08/82-12/86	W24EPR-U	4136	0.8	-	-	-	6
2.8 i XR 4x4	107	PR6		09/83-12/86	W22EPR-U	3088	0.8	W22TT	-	VW22	6
2.8 XR 4x4	110	PRT		02/85-12/86	W22EPR-U	3088	0.8	W22TT	-	VW22	6
2.8 XR4i	107	PR5		08/82-12/86	W22EPR-U	3088	0.8	W22TT	-	VW22	6
SIERRA (87-93)											
1.6	53/55	LSE(TL16); LSF		01/87-02/93	MA20PR-U	5013	0.9	-	-	-	4
1.6	55	LSE(TL16)		01/87-02/93	MA20P-U	5012	0.9	-	-	-	4
1.6 i	59	L6B		10/89-02/93	Q20PR-U11	3008	1.1	Q20TT	IQ20TT	IQ20TT	4
1.8	59	RED; REF		10/87-05/88	MA20PR-U	5013	0.9	-	-	-	4
1.8	64/66	R2A; R6A		01/87-02/93	Q20PR-U11	3008	1.1	Q20TT	IQ20TT	IQ20TT	4
1.8 TD	55	RFA; RFB; RFL		08/88-02/93	DG-004		11.5V				4
1.9	80	N8A(DL20H)		10/88-09/91	MA20PR-U	5013	0.9	-	-	-	4
2.0	77	NES		01/87-02/93	MA20PR-U	5013	0.9	-	-	-	4
2.0	77/80	N8A; N8C		01/87-02/93	Q20PR-U	3007	0.8	Q20TT	IQ20TT	IQ20TT	4
2.0 16V Cosworth 4x4	162	N5C; N5D		01/90-02/93	IQ27	5315	0.8	-	-	-	4
2.0 16V Cosworth 4x4 CAT	162	N5C		01/90-02/93	IQ27	5315	0.8	-	-	-	4
2.0 4x4	88/92	N9C		05/89-02/93	Q20PR-U	3007	0.8	Q20TT	IQ20TT	IQ20TT	4
2.0 i	74/85	N4A; N4I; NE5; NEJ		01/87-02/93	MA20PR-U	5013	0.9	-	-	-	4
2.0 i	80/88/90/92	N8A; N9A; N9B; N9C		05/89-02/93	Q20PR-U	3007	0.8	Q20TT	IQ20TT	IQ20TT	4
2.0 i CAT	74	N4B		01/87-02/93	MA20PR-U	5013	0.9	-	-	-	4
2.0 i DOHC	85	N9E		12/91-02/93	Q20PR-U	3007	0.8	Q20TT	IQ20TT	IQ20TT	4
2.0 RS Cosworth	150	N5B		01/87-12/90	IQ24	5314	0.8	-	-	-	4
2.0 RS500 Cosworth	164			07/87-12/87	IQ27	5315	0.8	-	-	-	4
2.3 D	49	YTR; YTT		01/87-02/93	DG-001		11V				4
2.8 4x4	110	PRG		01/87-08/88	W22EPR-U	3088	0.8	W22TT	-	VW22	6
2.8 i	105/107	PR7; PR8		01/87-02/93	W22EPR-U	3088	0.8	W22TT	-	VW22	6
2.8 i 4x4	107	PR7		01/87-02/93	W22EPR-U	3088	0.8	W22TT	-	VW22	6
2.8 i XR 4x4	107/110	PR7; PRG		01/87-02/93	W22EPR-U	3088	0.8	W22TT	-	VW22	6
2.9	107	B4C		08/88-02/93	T16EPR-U	5022	0.8	T16TT	IT16TT	IT16TT	6
2.9 4x4	107/110	B4C		08/88-02/93	T16EPR-U	5022	0.8	T16TT	IT16TT	IT16TT	6
2.9 i	107/110	B4B; B4C		08/88-02/93	T16EPR-U	5022	0.8	T16TT	IT16TT	IT16TT	6
2.9 i XR 4x4	110	B4A		08/88-02/93	Q20PR-U	3007	0.8	Q20TT	IQ20TT	IQ20TT	6
2.9 i XR 4x4	107	B4B		08/88-02/93	T16EPR-U	5022	0.8	T16TT	IT16TT	IT16TT	6
S-MAX (06-)											
1.6 EcoBoost	118	JTWA; JTWB	40000km Lifetime	02/11-	ITV20	5339	1.1	-	ITV20TT	ITV20TT	4
1.6 TDCi	85	T1WA; T1WB		02/11-	DG-603		5V				4
1.8 TDCi	74/92	FFWA; QYWA		05/06-	DG-121		10V				4
2.0	107	AOWA; AOWB		05/06-	ZT20EPR11	5087	1.1	T20TT	IT20TT	IT20TT	4
2.0 EcoBoost	149/176	TNWA; TPWA	40000km Lifetime	03/10-	ITV22	5340	0.8	-	-	-	4
2.0 Flexifuel	107	TBWA; TBWB	Flexible fuel	03/08-	ZT20EPR11	5087	1.1	T20TT	IT20TT	IT20TT	4
2.0 TDCi	96/100/103/120	AZWA; AZWC; QXWA; QXWB; QXWC; TXWA; UFWA; UKWA		05/06-06/10	DG-181		11V				4
2.0 TDCi	85	KLWA; TYWA	OE: 1427905	05/10-	DG-181		11V				4
2.2 TDCi	129/147	KNWA; Q4WA		03/08-	DG-614		11V				4
2.3	118	SEWA		07/07-06/10	ITV16	5338	1.1	-	ITV16TT	ITV16TT	4
2.5 ST	162	HUWA		05/06-06/10	IKH20	5344	1.1	-	IKH20TT	IKH20TT	5
STREET KA (03-05)											
1.6	70	CDA/B/C(BL16EFI)		05/03-07/05	T16VR-U10	5086	1.0	TV16TT	ITV16TT	ITV16TT	4
TAUNUS (70-76)											
1300	40	JAC		01/70-05/75	MA20P-U	5012	0.9	-	-	-	4
1600	53	LCJ		01/70-02/76	MA20P-U	5012	0.9	-	-	-	4
TAUNUS (75-79)											
1.3	40/43	JAC		05/75-07/79	MA20P-U	5012	0.9	-	-	-	4

Spark & Glow Plugs







Application Tables







	KW					Standard			Twin Tip				QTY	
FORD <i>continued</i>														
TAUNUS (75-79) <i>continued</i>														
1.6	50/53	LAD; LCJ		05/75-07/79	MA20P-U	5012	0.9	-	-	-	-	-	-	4
2.0	66	NX(TV20)		05/75-07/79	W20EXR-U	3066	0.8	W20TT	IW20TT	IW20TT	-	-	-	6
TAUNUS (79-82)														
1.3	43	JCC		07/79-07/82	MA20PR-U	5013	0.9	-	-	-	-	-	-	4
1.6	54	LCJ		07/79-07/82	MA20P-U	5012	0.9	-	-	-	-	-	-	4
2.0	74	NER		07/79-07/82	MA20P-U	5012	0.9	-	-	-	-	-	-	4
TOURNEO / GRAND TOURNEO Connect (13-)														
1.6 TDCi	55/ 70/ 85	T1GA; TZGA; TZGB; UBGA		09/13-	DG-603		5V							4
TOURNEO Connect (02-)														
1.8 16V	85	EYPA(ZH18 115)		06/02-06/06	T16VR-U10	5086	1.0	TV16TT	ITV16TT	ITV16TT	-	-	-	4
1.8 TDCi	66/81	HCPA; HCPB; P9PA; P9PB; P9PC; P9PD; R3PA; RWPA; RWPC; RWPD; RWPE; RWPF		06/02-	DG-121		10V							4
1.8 TDCi /TDDi /DI	55	BHPA; P7PA; P7PB; R2PA		06/02-	DG-121		10V							4
TOURNEO Courier (14-)														
1.5 TDCi	55	UGCA; UGCB; XUCC; XUCD		02/14-	DG-603		5V							4
1.6 TDCi	70	T3CA; T3CB; T3CC		02/14-	DG-603		5V							4
TRANSIT (77-86)														
1.6 (VAS, VLS, VZS)	48	4RB		12/77-10/86	MA20P-U	5012	0.9	-	-	-	-	-	-	4
1.6 (VCS, VDS)	48	B		11/77-10/86	MA20P-U	5012	0.9	-	-	-	-	-	-	4
1.6 (WS)	48	4RB		11/77-10/86	MA20P-U	5012	0.9	-	-	-	-	-	-	4
2.0 (VAS, VBLVIL, VLS, VUL, VZS)	43	4RC		12/77-07/82	MA20P-U	5012	0.9	-	-	-	-	-	-	4
2.0 (VAS, VIL, VLS, VUL, VZS)	57	4RC		11/77-10/86	MA16PR-U	5008	0.9	-	-	-	-	-	-	4
2.0 (VAS, VLS, VZS)	55	4RC		11/77-10/86	MA16PR-U	5008	0.9	-	-	-	-	-	-	4
2.0 (VGL, VSL, VTL)	43	4RC		11/77-07/82	MA20P-U	5012	0.9	-	-	-	-	-	-	4
2.0 (VGL, VSL, VTL, VCS, VDS)	57	NAW(TL20)		11/77-10/86	MA20P-U	5012	0.9	-	-	-	-	-	-	4
2.0 (VHL, VVS)	57	4RC		11/77-10/86	MA16PR-U	5008	0.9	-	-	-	-	-	-	4
2.0 (VVL)	55	4RC		11/77-10/86	MA16PR-U	5008	0.9	-	-	-	-	-	-	4
2.0 (VVS)	43	4RC		11/77-07/82	MA20PR-U	5013	0.9	-	-	-	-	-	-	4
2.4 D (VAS, VBL, VIL, VUL, VZS)	46	4AA		12/77-10/86	DG-012		11V							4
2.4 D (VGL, VSL, VTL, VCS, VDS)	46	4AA		11/77-09/85	DG-012		11V							4
2.4 D (VVS)	46	4AA		11/77-10/86	DG-012		11V							4
TRANSIT (85-92)														
1.6 (TAS)	46	LAT		09/85-09/92	MA20P-U	5012	0.9	-	-	-	-	-	-	4
1.6 (TBL, TES)	46	LAT		12/85-01/89	MA20P-U	5012	0.9	-	-	-	-	-	-	4
2.0 (TAL, TAS, TGL, TWS)	57	N6T		10/89-09/92	MA20PR-U	5013	0.9	-	-	-	-	-	-	4
2.0 (TBS, TCL, TCS) CAT	57	NAT(TL20)		12/85-09/92	MA20PR-U	5013	0.9	-	-	-	-	-	-	4
2.0 (TBS, TCL, TCS, TEL, TES)	57	NAT(TL20)		10/88-09/92	MA20PR-U	5013	0.9	-	-	-	-	-	-	4
2.0 (TTE, TTL, TTS)	57	NAT(TL20)		10/88-09/92	MA20PR-U	5013	0.9	-	-	-	-	-	-	4
2.0 (TUL) CAT	57	NAT(TL20)		10/88-09/92	MA20PR-U	5013	0.9	-	-	-	-	-	-	4
TRANSIT (91-94)														
2.0	66	NBA(TL20S)		09/91-09/94	MA20PR-U	5013	0.9	-	-	-	-	-	-	4
2.0 (EME/L/S, ENE/L/S)	72	NCA(TL20EFI)		09/91-08/94	MA20PR-U	5013	0.9	-	-	-	-	-	-	4
2.0 i (EAL, EAS)	72	NCA(TL20EFI)		09/91-06/94	MA20PR-U	5013	0.9	-	-	-	-	-	-	4
2.0 i (EBL, EDL, EGL, ESS, EUS)	72	NCA(TL20EFI)		09/91-07/94	MA20PR-U	5013	0.9	-	-	-	-	-	-	4
2.9 i	107	BRT		01/91-09/94	Q20PR-U11	3008	1.1	Q20TT	IQ20TT	IQ20TT	-	-	-	6
TRANSIT (94-00)														
2.0 (EAL, EAS)	84	NSF(DL20);NSG(DL20)		06/94-03/00	K20PR-U	3145	0.8	K20TT	IK20TT	IK20TT	-	-	-	4
2.0 (EAL, EAS)	84	NSF(DL20);NSG(DL20)	OEM Optional	06/94-03/00	PK22PR-L11S	3284	1.1	-	-	-	-	-	VK22G	4
2.0 (EBL, EBS, ECL, EDS, EDL, EGL, ESS, ESL, EUS)	84	NSF(DL20);NSG(DL20)		09/95-03/00	K20PR-U	3145	0.8	K20TT	IK20TT	IK20TT	-	-	-	4
2.0 (EBL, EBS, ECL, EDS, EDL, EGL, ESS, ESL, EUS)	84	NSF(DL20);NSG(DL20)	OEM Optional	09/95-03/00	PK22PR-L11S	3284	1.1	-	-	-	-	-	VK22G	4
2.0 (EME/L/S, ENE/L/S)	84	NSF(DL20);NSG(DL20)		08/94-03/00	K20PR-U	3145	0.8	K20TT	IK20TT	IK20TT	-	-	-	4
2.0 (EME/L/S, ENE/L/S)	84	NSF(DL20);NSG(DL20)	OEM Optional	08/94-03/00	PK22PR-L11S	3284	1.1	-	-	-	-	-	VK22G	4

	KW					Standard			Twin Tip		QTY
FORD <i>continued</i>											
TRANSIT (94-00) <i>continued</i>											
2.0 CNG	84	NSH		06/94-03/00	K20PR-U	3145	0.8	K20TT	IK20TT	IK20TT	4
2.0 CNG	84	NSH	OEM Optional	06/94-03/00	PK22PR-L11S	3284	1.1	-	-	VK22G	4
TRANSIT (00-06)											
2.0 DI (F_E_, F_F_)	55/ 63/ 74	ABFA; D3FA; F3FA		08/00-05/06	DG-130		11.5V				4
2.0 DI (F_E_, F_F_, F_G_)	55/ 63/ 74	ABFA; D3FA; F3FA		08/00-05/06	DG-130		11.5V				4
2.0 DI (FAE_, FAF_, FAG_)	55/ 63/ 74	ABFA; D3FA; F3FA		08/00-05/06	DG-130		11.5V				4
2.0 TDCi	92	FIFA		08/02-05/06	DG-130		11.5V				4
2.0 TDCi (F_E_, F_F_)	92	FIFA		08/02-05/06	DG-130		11.5V				4
2.0 TDCi (F_F_, F_E_, F_G_)	92	FIFA		08/02-05/06	DG-130		11.5V				4
2.3 16V (F_A_, F_B_, F_C_, F_D_)	107	E5FA(145)		04/01-05/06	VK20	5604	1.1	-	IK20TT	IK20TT	4
2.3 16V [RWD] (F_B_, F_C_, F_A_)	107	E5FA(145)		08/00-05/06	VK20	5604	1.1	-	IK20TT	IK20TT	4
2.3 16V [RWD] (FAA_, FAB_, FAC_)	107	E5FC(145)		04/01-01/03	PK20PR11	3168	1.1	K20TT	IK20TT	IK20TT	4
2.3 16V [RWD] (FAA_, FAB_, FAC_)	107	E5FA(145)		04/01-05/06	VK20	5604	1.1	-	IK20TT	IK20TT	4
2.4 DI (F_A_, F_B_, F_C_, F_D_)	55/ 66/ 88	D2FA; D2FB; D2FE; D4FA; F4FA		01/00-05/06	DG-130		11.5V				4
2.4 DI (F_B_, F_C_, F_A_)	66	D2FA; D2FB; D2FE		01/00-05/06	DG-130		11.5V				4
2.4 DI (FAA_, FAB_, FAC_, FAD_)	66	D2FA; D2FB; D2FE		01/00-05/06	DG-130		11.5V				4
2.4 DI [RWD] (F_B_, F_C_)	55	F4FA		01/00-05/06	DG-130		11.5V				4
2.4 DI [RWD] (F_B_, F_C_, F_A_)	88	D4FA		01/00-05/06	DG-130		11.5V				4
2.4 DI [RWD] (FAA_, FAB_, FAC_, FAD_)	55/88	D4FA; F4FA		01/00-05/06	DG-130		11.5V				4
2.4 TDCi	101	H9FA		03/04-05/06	DG-130		11.5V				4
2.4 TDdi	88	D4FA		08/00-06/01	DG-130		11.5V				4
2.4 TDE	85/92	DOFA; FXFA		07/01-05/06	DG-130		11.5V				4
2.4 TDE (F_C_, F_B_, F_A_)	92	DOFA		07/01-05/06	DG-130		11.5V				4
TRANSIT (06-)											
2.2 TDCi	63/ 81/ 85/ 96/ 103	P8FA; P8FB; PGFA; PGFB; QVFA; QWFA; SRFA; SRFB; SRFC; SRFD; SRFE; UHFA; UHFB; UHFC		04/06-	DG-130		11.5V				4
2.3 16V [RWD]	107	GZFA; GZFB; GZFC		04/06-	VT20	5638	1.1	-	IT20TT	IT20TT	4
2.4 TDCi	74/ 85/ 103	H9FD; JXFA; JXFC; PHFA; PHFC		04/06-	DG-130		11.5V				4
2.4 TDCi [RWD]	74/ 85/ 103	H9FD; JXFA; JXFC; PHFA; PHFC		04/06-	DG-130		11.5V				4
2.4 TDCi 4x4	103	H9FB		11/06-	DG-130		11.5V				4
3.2 TDCi	147	SAFA; SAFB		02/08-	DG-130		11.5V				5
3.2 TDCi [RWD]	147	SAFA; SAFB		09/07-	DG-130		11.5V				5
TRANSIT CONNECT (02-)											
1.8 16V	85	EYPA(ZH18 115)		06/02-06/06	T16VR-U10	5086	1.0	TV16TT	ITV16TT	ITV16TT	4
1.8 Di	55	BHPA; P7PA; P7PB; R2PA		06/02-	DG-121		10V				4
1.8 TDCi	66/81	HCPA; HCPB; P9PA; P9PB; P9PC; P9PD; R3PA; RWPA; RWPC; RWPD; RWPE; RWPF		06/02-	DG-121		10V				4
TRANSIT Connect (13-)											
1.6 TDCi	55/ 70/ 85	T1GA; TZGA; TZGB; UBGA		09/13-	DG-603		5V				4
TRANSIT Courier (14-)											
1.5 TDCi	55	UGCA; UGCB; XUCC; XUCCD		02/14-	DG-603		5V				4
1.6 TDCi	70	T3CA; T3CB; T3CC		02/14-	DG-603		5V				4
TRANSIT TOURNEO (94-00)											
2.0	84	NSG(DL20)		11/94-12/00	K20PR-U	3145	0.8	K20TT	IK20TT	IK20TT	4
2.0	84	NSG(DL20)	OEM Optional	11/94-12/00	PK22PR-L11S	3284	1.1	-	-	VK22G	4

Spark & Glow Plugs



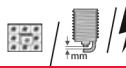







Application Tables

	KW					Standard			Twin Tip				QTY	
FORD continued														
TRANSIT TOURNEO (06-)														
2.2 TDCi	81/85/96/103	PGFA; PGFB; QVFA; QWFA; SRFA; SRFB; SRFC; SRFD; SRFE		07/06-	DG-130		11.5V							4
FORD AUSTRALIA														
LASER (81-02)														
2.0 i	98	FS		04/01-09/02	Q20PR-U11	3008	1.1	Q20TT	IQ20TT	IQ20TT				4
TELSTAR (83-96)														
2.0	85	FS		01/92-08/94	Q20PR-U11	3008	1.1	Q20TT	IQ20TT	IQ20TT				4
2.0 EFI	85	FS		10/94-11/96	Q20PR-U11	3008	1.1	Q20TT	IQ20TT	IQ20TT				4
2.0 TX5 EFI	85	FS		01/92-08/94	Q20PR-U11	3008	1.1	Q20TT	IQ20TT	IQ20TT				4
FORD OTOSAN														
TAUNUS (89-)														
1.6	52			01/89-	MA20PR-U	5013	0.9	-	-	-				4
FORD USA														
AEROSTAR (85-97)														
3.0 i V6	108			09/85-12/97	PT16EPR-L13	5070	1.3	-	IT16TT	IT16TT				6
4.0 i V6 4WD	115			09/89-12/97	PT16EPR-L13	5070	1.3	-	IT16TT	IT16TT				6
BRONCO II (85-90)														
2.9 i V6 4x4	104			09/85-08/90	T16EPR-U	5022	0.8	T16TT	IT16TT	IT16TT				6
ECONOLINE (76-92)														
5.0	136			10/85-09/91	T16PR-U11	5026	1.1	-	ITF16TT	ITF16TT				8
ESCAPE (01-07)														
2.0	91			01/01-02/04	PT16VR13	5068	1.3	TV16TT	ITV16TT	ITV16TT				4
EXCURSION (99-05)														
6.8 D 4WD	231			08/99-09/05	T20EPR-U	5032	0.8	T20TT	IT20TT	IT20TT				10
EXPLORER (93-01)														
4.0 V6 4WD	115/150/152			03/95-12/01	PT16EPR-L13	5070	1.3	-	IT16TT	IT16TT				6
4.0 V6 4WD	121			01/93-	T20EPR-U15	5033	1.5	T20TT	IT20TT	IT20TT				6
F150 (96-03)														
4.2	148/150/157			10/96-11/03	PT16EPR-L13	5070	1.3	-	IT16TT	IT16TT				6
MUSTANG (93-)														
3.8	112			09/93-	PT16EPR-L13	5070	1.3	-	IT16TT	IT16TT				6
4.6	160/165/192/225/236	99W		11/95-09/03	PT16EPR-L13	5070	1.3	-	IT16TT	IT16TT				8
MUSTANG (04-)														
4.6 V8	224			12/04-	PT16EPR-L13	5070	1.3	-	IT16TT	IT16TT				8
PROBE I (88-93)														
3.0 V6	104			08/88-07/93	T20EPR-U15	5033	1.5	T20TT	IT20TT	IT20TT				6
PROBE II (93-98)														
2.0 16V	85	FS		10/93-03/98	Q20PR-U11	3008	1.1	Q20TT	IQ20TT	IQ20TT				4
2.5 V6 24V	119/120	KL		10/93-03/98	KJ20CR-U11	3451	1.1	K20TT	IK20TT	IK20TT				6
TAURUS (88-92)														
3.8	104			02/88-10/92	T16NR-U11	5047	1.1	-	IT16TT	IT16TT				6
TAURUS (91-95)														
3.0	164			10/91-09/95	T16EPR-U	5022	0.8	T16TT	IT16TT	IT16TT				6
TAURUS (95-)														
3.0	95/108			09/95-	PT16EPR-L13	5070	1.3	-	IT16TT	IT16TT				6
3.0 24V	130/149			05/96-	PT16EPR-L13	5070	1.3	-	IT16TT	IT16TT				6
3.0 Flex-Fuel	108			09/95-	PT16EPR-L13	5070	1.3	-	IT16TT	IT16TT				6
3.0 V6	115			03/99-	PT16EPR-L13	5070	1.3	-	IT16TT	IT16TT				6
THUNDERBIRD (93-97)														
3.8	104			01/93-12/96	T16NR-U11	5047	1.1	-	IT16TT	IT16TT				6
WINDSTAR (95-)														
3.0 V6	109			03/95-02/99	PT16EPR-L13	5070	1.3	-	IT16TT	IT16TT				6
3.0 V6	108			02/99-	T20EPR-U	5032	0.8	T20TT	IT20TT	IT20TT				6
FSO														
125P (67-92)														
1.3	47	116 C 076		10/67-08/92	W20EP-U	3043	0.8	W20TT	IW20TT	IW20TT				4
1.3 1300	47	116 C 076		10/67-08/92	W20EP-U	3043	0.8	W20TT	IW20TT	IW20TT				4
1.5	55	115 C 076		10/67-08/92	W20EP-U	3043	0.8	W20TT	IW20TT	IW20TT				4
1.5 1500	55	115 C 076		10/67-08/92	W20EP-U	3043	0.8	W20TT	IW20TT	IW20TT				4

	KW								QTY		
FSO continued											
126P (72-00)											
0.6	17/22	126 A1.048		07/72-12/91	W22FPR-U	4022	0.7	-	-	-	2
650	18	126 A1.048		07/81-09/00	W20EPR-U	3047	0.8	W20TT	IW20TT	IW20TT	2
127P (69-76)											
0.9	33	127GL.000		03/71-10/76	W20EPR-U	3047	0.8	W20TT	IW20TT	IW20TT	4
LANOS (04-08)											
1.4	55			05/04-10/08	W20EPR-U	3047	0.8	W20TT	IW20TT	IW20TT	4
1.5	63	A15SMS		05/04-07/05	W20EPR-U	3047	0.8	W20TT	IW20TT	IW20TT	4
1.6 16V	78	A16DMS		05/04-10/08	K20PR-U11	3121	1.1	K20TT	IK20TT	IK20TT	4
POLONEZ I (77-91)											
1.3	48	116 C 076		01/78-12/80	W20EP-U	3043	0.8	W20TT	IW20TT	IW20TT	4
1.5	55/60	AA		10/77-08/88	W20EP-U	3043	0.8	W20TT	IW20TT	IW20TT	4
1.5 Turbo	70	AA		01/78-12/91	W20EP-U	3043	0.8	W20TT	IW20TT	IW20TT	4
1.6	64	CB		08/86-08/88	W22EPR-U	3088	0.8	W22TT	-	VW22	4
POLONEZ II (88-92)											
1.5	55	AA		08/88-08/92	W20EP-U	3043	0.8	W20TT	IW20TT	IW20TT	4
1.5 i	55			08/88-08/92	W20EP-U	3043	0.8	W20TT	IW20TT	IW20TT	4
1.6	64	CB		08/88-08/92	W22EPR-U	3088	0.8	W22TT	-	VW22	4
1.9 D	51	XUD 9A		12/91-08/92	DG-001		11V				4
POLONEZ III (92-02)											
1.4 i 16V	76	Rover K16 DOHC		09/92-03/02	K20PR-U	3145	0.8	K20TT	IK20TT	IK20TT	4
1.6 i	57			09/92-03/02	W22EPR-U	3088	0.8	W22TT	-	VW22	4
1.9 D	51	XUD 9A		09/92-03/02	DG-001		11V				4
GAZ											
GAZELLE (93-01)											
2.3	96	ZMZ-4062.10		10/93-08/01	W16EPR-U	3021	0.8	W16TT	IW16TT	IW16TT	4
2.4	66	ZMZ-402.10		10/93-08/01	W16FPR-U	4192	0.7	-	-	-	4
2.4 D	67			10/93-08/01	DG-005		11V				4
VOLGA (72-93)											
2.4	67/77			02/72-01/93	W16FPR-U	4192	0.7	-	-	-	4
VOLGA (93-10)											
2.3	96	ZMZ-4062.10		02/93-12/10	W16EPR-U	3021	0.8	W16TT	IW16TT	IW16TT	4
2.4	59/66/74	ZMZ-4021.10		02/93-12/10	W16FPR-U	4192	0.7	-	-	-	4
GEELY											
BL (05-)											
1.5	69	MR479QA		09/05-	K16R-U11	3120	1.1	K16TT	IK16TT	IK16TT	4
CK (05-)											
1.5	69	MR479QA		09/05-	K16R-U11	3120	1.1	K16TT	IK16TT	IK16TT	4
1.6	79	MR481QA		09/05-	K20PR-U	3145	0.8	K20TT	IK20TT	IK20TT	4
HQ (05-)											
1.0	38	JL376QE		09/05-	W16EXR-U	3031	0.8	W16TT	IW16TT	IW16TT	3
MR (05-)											
1.5	69	MR479QA		09/05-	K16R-U11	3120	1.1	K16TT	IK16TT	IK16TT	4
GMC											
G SERIE (75-84)											
5.0	114	LG4		10/78-03/84	T16PR-U11	5026	1.1	-	ITF16TT	ITF16TT	8
JIMMY (94-02)											
4.3	142	L35		10/94-09/02	T16EPR-U15	5023	1.5	T16TT	IT16TT	IT16TT	6
4.3 AWD	142	L35		10/94-09/02	T16EPR-U15	5023	1.5	T16TT	IT16TT	IT16TT	6
SIERRA (97-07)											
5.3	213	LM7		10/98-12/07	T20EPR-U15	5033	1.5	T20TT	IT20TT	IT20TT	8
5.3 4x4	213	LM7		10/98-12/07	T20EPR-U15	5033	1.5	T20TT	IT20TT	IT20TT	8
SUBURBAN (99-)											
5.3	213	LM7		10/99-	T20EPR-U15	5033	1.5	T20TT	IT20TT	IT20TT	8
GREAT WALL											
HOVER H5 (10-)											
2.4	93			01/13-	K20PR-U11	3121	1.1	K20TT	IK20TT	IK20TT	4
2.4 4WD	93			01/13-	K20PR-U11	3121	1.1	K20TT	IK20TT	IK20TT	4
2.4 All-wheel Drive	100			06/10-	K20PR-U11	3121	1.1	K20TT	IK20TT	IK20TT	4
HOLDEN											
APOLLO (JM) (93-95)											
2.2 i	93	5S-FE		03/93-05/95	PK20TR11	3253	1.1	K20TT	IK20TT	IK20TT	4
ASTRA G (TS) (98-06)											
2.0 i Turbo	147	Z 20 LET		06/02-07/04	K20TXR	5063	1.0	K20TT	IK20TT	IK20TT	4
2.0 i Turbo	147	Z 20 LER		06/02-07/04	KJ16CR-L11	3132	1.1	K16TT	IK16TT	IK16TT	4
ASTRA H (AH) (05-10)											
1.8 i	92	Z 18 XE		07/05-03/08	KJ16CR-L11	3132	1.1	K16TT	IK16TT	IK16TT	4









Spark & Glow Plugs

Application Tables

	KW										QTY
HOLDEN <i>continued</i>											
ASTRA H (AH) (05-10) <i>continued</i>											
1.8 i	103	Z 18 XER	Ch: >D2999999; D5999999; D8999999; DG999999; 9B999999	04/07-03/10	KJ16CR-L11	3132	1.1	K16TT	IK16TT	IK16TT	4
1.8 i	103	Z 18 XER	Ch: E2000001; E8000001; EG000001>	04/07-03/10	KJ20CR-L11	3169	1.1	K20TT	IK20TT	IK20TT	4
2.0 i Turbo	147	Z 20 LER		07/05-03/10	KJ16CR-L11	3132	1.1	K16TT	IK16TT	IK16TT	4
JACKAROO / MONTEREY (92-04)											
3.5 RS 4x4 (UBS26)	158	6VE1		03/98-09/04	PK16PR-L11	3275	1.1	-	IK16TT	IK16TT	6
NOVA (91-94)											
1.8	85/86	7A-FE		06/92-10/94	K20R-U	3122	0.8	K20TT	IK20TT	IK20TT	4
NOVA (94-97)											
1.8 i	85	7A-FE		10/94-12/97	K20R-U	3122	0.8	K20TT	IK20TT	IK20TT	4
RODEO (78-)											
3.5 i (TFR26)	147	6VE1		02/03-12/05	PK16PR-L11	3275	1.1	-	IK16TT	IK16TT	6
3.5 i (TFS26)	147	6VE1		02/03-12/05	PK16PR-L11	3275	1.1	-	IK16TT	IK16TT	6
3.5 i 4x4 (TFS26)	147	6VE1		02/03-12/05	PK16PR-L11	3275	1.1	-	IK16TT	IK16TT	6
STATESMAN (99-03)											
5.7 i V8	220	LS1		06/99-11/02	PTJ16R15	5077	1.5	-	IT16TT	IT16TT	8
HONDA											
ACCORD I (78-83)											
1.6 L/EX (SJ, SY)	59	EL		01/79-09/83	W16EXR-U	3031	0.8	W16TT	IW16TT	IW16TT	4
1.6 L/EX (SY)	59	EL		01/78-09/83	W16EXR-U	3031	0.8	W16TT	IW16TT	IW16TT	4
ACCORD II (83-85)											
1.6 EX (AC)	65	EZ		09/83-10/85	W20EXR-U11	3067	1.1	W20TT	IW20TT	IW20TT	4
1.8 EX (AD)	74	ET1		09/83-10/85	W16EXR-U	3031	0.8	W16TT	IW16TT	IW16TT	4
ACCORD III (85-89)											
1.6 L (CA4)	65	A16A1		11/85-12/89	W20EXR-U11	3067	1.1	W20TT	IW20TT	IW20TT	4
2.0 EX	75	A20A1		10/87-12/89	W20EXR-U11	3067	1.1	W20TT	IW20TT	IW20TT	4
2.0 EX (CA5)	75/ 76/ 78	A20A1; A20A2		11/85-12/89	W20EXR-U11	3067	1.1	W20TT	IW20TT	IW20TT	4
2.0 EXi (CA5)	85/90	A20A3; A20A4		11/85-12/89	W20EXR-U11	3067	1.1	W20TT	IW20TT	IW20TT	4
2.0 i 16V (CA5)	98/ 101	B20A2; B20A8		01/87-12/89	Q20PR-U11	3008	1.1	Q20TT	IQ20TT	IQ20TT	4
ACCORD IV (90-94)											
1.8	77	F18A2		01/90-12/91	KJ20CR-L11	3169	1.1	K20TT	IK20TT	IK20TT	4
2.0 16V (CB3)	66/81	F20A2; F20A6		01/90-03/93	KJ20CR-L11	3169	1.1	K20TT	IK20TT	IK20TT	4
2.0 i 16V (CB3)	98	F20A8		01/90-03/93	KJ20CR-L11	3169	1.1	K20TT	IK20TT	IK20TT	4
2.0 i 16V (CC1)	98	F20A7		01/92-09/93	KJ20CR-L11	3169	1.1	K20TT	IK20TT	IK20TT	4
2.0 i 16V (CC9)	98	F20Z3		03/93-12/93	KJ20CR-L11	3169	1.1	K20TT	IK20TT	IK20TT	4
2.2 i 16V (CB7)	110	F22A3		01/90-03/93	KJ20CR-L11	3169	1.1	K20TT	IK20TT	IK20TT	4
2.2 i 16V (CB8)	108/ 110	F22A7; F22A8		01/91-12/93	KJ20CR-L11	3169	1.1	K20TT	IK20TT	IK20TT	4
2.2 i 16V Automatik (CB7)	108	F22A3		01/90-03/93	KJ20CR-L11	3169	1.1	K20TT	IK20TT	IK20TT	4
ACCORD V (93-98)											
1.9 i (CE7)	85	F18A3		02/96-10/98	KJ20CR-L11	3169	1.1	K20TT	IK20TT	IK20TT	4
2.0 (CD9)	100	F20B3		09/93-12/97	KJ20CR-L11	3169	1.1	K20TT	IK20TT	IK20TT	4
2.0 i	85	F20Z2		03/93-01/96	KJ20CR-L11	3169	1.1	K20TT	IK20TT	IK20TT	4
2.0 i LS (CE8)	96	F20Z1		02/96-10/98	KJ20CR-L11	3169	1.1	K20TT	IK20TT	IK20TT	4
2.0 i LS 16V (CE2)	100	F20B3		09/93-02/98	KJ20CR-L11	3169	1.1	K20TT	IK20TT	IK20TT	4
2.0 i S	96	F20Z1		03/93-01/96	KJ20CR-L11	3169	1.1	K20TT	IK20TT	IK20TT	4
2.0 TDi (CF1)	77	20T2N		04/96-10/98	DG-101		11V				4
2.2 i ES (CD7)	110	F22B5		09/93-02/98	KJ20CR-L11	3169	1.1	K20TT	IK20TT	IK20TT	4
2.2 i ES (CE1)	110	F22B5		09/93-02/98	KJ20CR-L11	3169	1.1	K20TT	IK20TT	IK20TT	4
2.2 i VTEC (CE9)	110	F22Z2		02/96-10/98	KJ20CR-U11	3451	1.1	K20TT	IK20TT	IK20TT	4
2.3 i SR	116	H23A3		03/93-01/96	KJ20CR-L11	3169	1.1	K20TT	IK20TT	IK20TT	4
ACCORD VI (97-05)											
1.6	85	D16B6		12/99-12/02	KJ16CR-L11	3132	1.1	K16TT	IK16TT	IK16TT	4
1.6 i	85	D16B6		10/98-12/02	KJ16CR-L11	3132	1.1	K16TT	IK16TT	IK16TT	4
1.6 LS	79	D16B7		10/98-12/02	KJ16CR-U11	3311	1.1	K16TT	IK16TT	IK16TT	4
1.8 i	100	F18B2		10/98-12/02	KJ20CR-L11	3169	1.1	K20TT	IK20TT	IK20TT	4
1.8 i (CH6)	100	F18B2		12/99-12/02	KJ20CR-L11	3169	1.1	K20TT	IK20TT	IK20TT	4
2.0 (CH7)	108	F20B6		12/99-12/02	KJ20CR-L11	3169	1.1	K20TT	IK20TT	IK20TT	4
2.0 i	108	F20B6		10/98-01/01	KJ20SR11	3378	1.1	-	IK20TT	IK20TT	4
2.0 i 16V	108	F20B5		02/98-06/03	KJ20CR-L11	3169	1.1	K20TT	IK20TT	IK20TT	4
2.0 TDi	77	20T2N		12/99-10/00	DG-101		11V				4







Spark & Glow Plugs

Application Tables

	KW					Standard				QTY	
HONDA <i>continued</i>											
ACCORD VI (97-05) <i>continued</i>											
2.0 Turbo Di	77	20T2N		02/99-12/02	DG-101		11V			4	
2.2 Type-R	156	H22A7		02/99-12/02	PKJ20CR-L11	3247	1.1	-	IK20TT	IK20TT	4
2.3 (CK2)	113	F23Z5		01/01-06/03	KJ20CR-L11	3169	1.1	K20TT	IK20TT	IK20TT	4
2.3 (CL4)	113	F23Z5		11/00-12/02	KJ20CR-L11	3169	1.1	K20TT	IK20TT	IK20TT	4
3.0 V6 24V (CG2)	147	J30A1		02/98-06/03	KJ16CR-L11	3132	1.1	K16TT	IK16TT	IK16TT	6
3.0 Vtec (CK1)	147	J30A1		10/98-12/02	KJ16CR-L11	3132	1.1	K16TT	IK16TT	IK16TT	6
ACCORD VII (03-)											
2.0 (CL7)	114	K20A6		02/03-05/08	KJ20DR-M11	3374	1.1	-	IK20TT	IK20TT	4
2.0 (CM1)	114	K20A6		04/03-05/08	KJ20DR-M11	3374	1.1	-	IK20TT	IK20TT	4
2.0 All-wheel Drive (CL8)	114	K20A6		02/03-05/08	KJ20DR-M11	3374	1.1	-	IK20TT	IK20TT	4
2.2 i-CTDi	103	N22A1		01/04-	DG-601		11V			4	
2.4 (CL9)	140	K24A3		02/03-05/08	SKJ20DR-M11	3377	1.1	-	IK20TT	IK20TT	4
2.4 (CM2)	140	K24A		04/03-05/08	KJ20DR-M11	3374	1.1	-	IK20TT	IK20TT	4
2.4 (CM2)	140	K24A	OEM Optional	04/06-05/08	SKJ20DR-M11	3377	1.1	-	IK20TT	IK20TT	4
ACCORD VIII (08-)											
2.0 i	110/115	R20A3; R20A4		07/08-	SKJ20DR-M11S	3432	1.1	-	-	-	4
2.2 i-DTEC	110	N22B1		07/08-	DG-601		11V			4	
2.4 (CU6)	148	K24Z3		06/08-12/08	SKJ20DR-M11	3377	1.1	-	IK20TT	IK20TT	4
2.4 i	148	K24Z3		05/11-	VXUHC22G	5652	0.9	-	-	VXHUC22G	4
ACTY (79-86)											
0.6	23	EH		01/82-06/86	W20EXR-U	3066	0.8	W20TT	IW20TT	IW20TT	2
CAPA (98-02)											
1.5 16V	72	D15B		04/98-09/02	KJ16CR-L11	3132	1.1	K16TT	IK16TT	IK16TT	4
1.5 4x4	72	D15B		01/98-09/02	KJ16CR-L11	3132	1.1	K16TT	IK16TT	IK16TT	4
CITY (99-04)											
1.3 4WD	63	L13A1		09/01-10/04	K20PR-U11	3121	1.1	K20TT	IK20TT	IK20TT	4
CITY (03-)											
1.3	60	L13A3		10/05-	K20PR-U11	3121	1.1	K20TT	IK20TT	IK20TT	4
1.3 SES	63	L13A1		05/03-09/05	K20PR-U11	3121	1.1	K20TT	IK20TT	IK20TT	4
CITY (08-)											
1.4 i-V TEC	73	L13Z1		09/08-	DK20PR-D13	3476	1.3	-	-	VFK20F	4
CIVIC I (72-84)											
1200 (SB1)	40	EB1		07/72-02/77	W20EPR-U	3047	0.8	W20TT	IW20TT	IW20TT	4
1200 (SB2)	40	EB2		03/77-12/80	W20EPR-U	3047	0.8	W20TT	IW20TT	IW20TT	4
1300 L	33/44	EN1; EN2		09/80-09/83	W20EPR-U	3047	0.8	W20TT	IW20TT	IW20TT	4
1300 S	52	EN4		10/79-12/84	W20EPR-U	3047	0.8	W20TT	IW20TT	IW20TT	4
CIVIC II (79-83)											
1300	44	EN1		09/79-09/83	W20EPR-U	3047	0.8	W20TT	IW20TT	IW20TT	4
1300 L (SS)	44	EN1		09/79-09/83	W20EPR-U	3047	0.8	W20TT	IW20TT	IW20TT	4
CIVIC III (83-87)											
1.2 (AL)	40	ZA2		01/84-10/87	W20EXR-U11	3067	1.1	W20TT	IW20TT	IW20TT	4
1.3	52	EV2		10/83-10/87	W20EXR-U11	3067	1.1	W20TT	IW20TT	IW20TT	4
1.3 (AG)	52	EV2		10/83-10/87	W20EXR-U11	3067	1.1	W20TT	IW20TT	IW20TT	4
1.5 (AN)	63	EW2		10/83-10/87	W20EXR-U11	3067	1.1	W20TT	IW20TT	IW20TT	4
1.5 4WD (AR)	63	EW2		01/85-10/87	W20EXR-U11	3067	1.1	W20TT	IW20TT	IW20TT	4
1.5 GL	63	EW2		10/83-10/87	W20EXR-U11	3067	1.1	W20TT	IW20TT	IW20TT	4
1.5 GL (AH)	63	EW2		10/83-10/87	W20EXR-U11	3067	1.1	W20TT	IW20TT	IW20TT	4
1.5 GT	74	EW3		01/85-10/87	W20EXR-U11	3067	1.1	W20TT	IW20TT	IW20TT	4
1.5 GT (AH)	74	EW3		01/85-10/87	W20EXR-U11	3067	1.1	W20TT	IW20TT	IW20TT	4
1.5 GTI (AH)	66	EW4		03/86-10/87	W20EXR-U11	3067	1.1	W20TT	IW20TT	IW20TT	4
CIVIC IV (87-95)											
1.3 (EC8)	55	D13B1		10/87-12/89	Q20PR-U11	3008	1.1	Q20TT	IQ20TT	IQ20TT	4
1.3 16 V (EC8) CAT	55	D13B2		09/89-09/91	K20PR-U11	3121	1.1	K20TT	IK20TT	IK20TT	4
1.4 i 16V (EE1)	66	D14A1		01/88-12/92	Q20PR-U11	3008	1.1	Q20TT	IQ20TT	IQ20TT	4
1.4 L (EC9)	66	D14A1		10/87-12/89	Q20PR-U11	3008	1.1	Q20TT	IQ20TT	IQ20TT	4
1.4 L (ED2)	66	D14A1		10/87-12/89	Q20PR-U11	3008	1.1	Q20TT	IQ20TT	IQ20TT	4
1.5 i 16V	66	D15B2		10/88-09/91	K20PR-U11	3121	1.1	K20TT	IK20TT	IK20TT	4
1.5 i 16V	66	D15B2		10/87-09/91	Q20PR-U11	3008	1.1	Q20TT	IQ20TT	IQ20TT	4
1.5 i 16V (ED3)	69	D15B2		10/87-09/91	Q20PR-U11	3008	1.1	Q20TT	IQ20TT	IQ20TT	4
1.5 i 16V (ED6)	69	D15B2		10/88-09/91	K20PR-U11	3121	1.1	K20TT	IK20TT	IK20TT	4
1.5 i 16V (EE2)	69	D15B2		01/88-11/91	Q20PR-U11	3008	1.1	Q20TT	IQ20TT	IQ20TT	4
1.6 4x4	85	D16A7		01/88-12/92	Q20PR-U11	3008	1.1	Q20TT	IQ20TT	IQ20TT	4
1.6 i 16V	96	D16A7		09/87-09/91	Q20PR-U11	3008	1.1	Q20TT	IQ20TT	IQ20TT	4
1.6 i 16V (ED4)	80/81	D16A6; D16Z2		10/87-09/91	Q20PR-U11	3008	1.1	Q20TT	IQ20TT	IQ20TT	4
1.6 i 16V (ED7)	80/81	D16A6; D16Z2		10/87-09/91	Q20PR-U11	3008	1.1	Q20TT	IQ20TT	IQ20TT	4
1.6 i 16V 4WD (EE4)	80/81	D16A6		01/88-02/95	Q20PR-U11	3008	1.1	Q20TT	IQ20TT	IQ20TT	4







Spark & Glow Plugs

Application Tables

	KW				Standard 			Twin Tip 			QTY
HONDA <i>continued</i>											
CIVIC IV (87-95) <i>continued</i>											
1.6 i 16V 4x4	80	D16A6		10/89-09/91	Q20PR-U11	3008	1.1	Q20TT	IQ20TT	IQ20TT	4
1.6 i 16V Vtec (EE9)	110	B16A1		10/89-09/91	K20PR-L11	3144	1.1	K20TT	IK20TT	IK20TT	4
CIVIC IX (12-)											
1.4 i-VTEC	73	L13Z4		02/12-	SKJ20DR-M13	3401	1.3	-	IK20TT	IK20TT	4
1.8	104	R18Z1; R18Z4		02/12-	DXU22HCR-D11S	3483	1.1	-	-	DXU22HCR-D11S	4
1.8 i-VTEC	104	R18Z4		02/12-	DXU22HCR-D11S	3483	1.1	-	-	DXU22HCR-D11S	4
CIVIC V (91-97)											
1.3	55	D13B2		01/92-12/92	K20PR-U11	3121	1.1	K20TT	IK20TT	IK20TT	4
1.3 16V (EG3)	55	D13B2		10/91-11/95	K20PR-U11	3121	1.1	K20TT	IK20TT	IK20TT	4
1.4 16V	66	D14A2		01/95-04/97	K20PR-U11	3121	1.1	K20TT	IK20TT	IK20TT	4
1.5 i 16V (EG4)	69	D15Z1		10/91-11/95	KJ16CR-L11	3132	1.1	K16TT	IK16TT	IK16TT	4
1.5 i 16V (EG4)	66	D15B2		10/91-11/95	Q20PR-U11	3008	1.1	Q20TT	IQ20TT	IQ20TT	4
1.5 i 16V (EG8)	69	D15Z1		10/91-11/95	KJ16CR-L11	3132	1.1	K16TT	IK16TT	IK16TT	4
1.5 i LSi (EJ2)	74	D15B7		08/93-11/95	KJ20CR-L11	3169	1.1	K20TT	IK20TT	IK20TT	4
1.6 16V Vtec (EG5)	92	D16Z6		10/91-11/95	K20PR-L11	3144	1.1	K20TT	IK20TT	IK20TT	4
1.6 16V Vtec (EH9)	92	D16Z6		10/91-11/95	K20PR-L11	3144	1.1	K20TT	IK20TT	IK20TT	4
1.6 4x4	92	D16Z7		01/92-10/95	K20PR-U11	3121	1.1	K20TT	IK20TT	IK20TT	4
1.6 i Vtec (EJ1)	92	D16Z9		01/94-03/96	K20PR-U11	3121	1.1	K20TT	IK20TT	IK20TT	4
1.6 VTi (EG9)	118	B16A2		10/91-11/95	K20PR-L11	3144	1.1	K20TT	IK20TT	IK20TT	4
1.6 VTi 16V (EG6)	118	B16A2		10/91-11/95	K20PR-L11	3144	1.1	K20TT	IK20TT	IK20TT	4
CIVIC VI (94-01)											
1.4 16V (MB8)	66	D14A8		04/98-02/01	IK20	5304	1.1	-	IK20TT	IK20TT	4
1.4 16V (MB8)	55	D14A7		04/98-02/01	KJ16CR-L11	3132	1.1	K16TT	IK16TT	IK16TT	4
1.4 i (EJ9)	66	D14A4		11/95-02/01	K20PR-L11	3144	1.1	K20TT	IK20TT	IK20TT	4
1.4 i (EJ9)	55	D14A3		11/95-02/01	K20PR-U11	3121	1.1	K20TT	IK20TT	IK20TT	4
1.4 i (MA8, MB2)	55/66	D14A2; D14A5		09/94-02/01	K20PR-U11	3121	1.1	K20TT	IK20TT	IK20TT	4
1.4 i S (EJ9)	66	D14A4		11/95-02/01	K20PR-L11	3144	1.1	K20TT	IK20TT	IK20TT	4
1.5 16V (MB3)	84	D15Z8		01/97-02/01	KJ16CR-L11	3132	1.1	K16TT	IK16TT	IK16TT	4
1.5 16V (MB9)	84	D15Z8		04/98-02/01	KJ16CR-L11	3132	1.1	K16TT	IK16TT	IK16TT	4
1.5 i (EK3)	84	D15Z6		11/95-02/01	KJ16CR-L11	3132	1.1	K16TT	IK16TT	IK16TT	4
1.5 i Vtec-E (MA9)	66	D15Z3		09/94-01/97	KJ16CR-L11	3132	1.1	K16TT	IK16TT	IK16TT	4
1.6 16V (MB4)	85	D16B2		01/97-02/01	Q20PR-U11	3008	1.1	Q20TT	IQ20TT	IQ20TT	4
1.6 16V (MC1)	85	D16B2		04/98-02/01	Q20PR-U11	3008	1.1	Q20TT	IQ20TT	IQ20TT	4
1.6 i	77	D16Y7		03/96-03/00	KJ16CR-L11	3132	1.1	K16TT	IK16TT	IK16TT	4
1.6 i (EK1)	84	D16Y5		11/95-02/01	KJ16CR-L11	3132	1.1	K16TT	IK16TT	IK16TT	4
1.6 i (MB1)	83	D16Y3		09/94-01/97	K20PR-L11	3144	1.1	K20TT	IK20TT	IK20TT	4
1.6 i Vtec	118	B16A2		04/99-12/00	K20PR-L11	3144	1.1	K20TT	IK20TT	IK20TT	4
1.6 i Vtec	92	D16Y8		11/95-02/01	KJ16CR-L11	3132	1.1	K16TT	IK16TT	IK16TT	4
1.6 i Vtec (MB1)	93	D16Y2		09/94-01/97	K20PR-L11	3144	1.1	K20TT	IK20TT	IK20TT	4
1.6 VTi	118	B16A2		01/97-02/01	K20PR-L11	3144	1.1	K20TT	IK20TT	IK20TT	4
1.6 VTi (EK4)	118	B16A2		11/95-02/01	K20PR-L11	3144	1.1	K20TT	IK20TT	IK20TT	4
1.8 16V (MB6)	124	B18C4		01/97-02/01	K20PR-L11	3144	1.1	K20TT	IK20TT	IK20TT	4
1.8 16V (MC2)	124	B18C4		04/98-02/01	K20PR-L11	3144	1.1	K20TT	IK20TT	IK20TT	4
2.0 i D (MC3)	77	20T2N		04/98-02/01	DG-101		11V				4
2.0 i TD (MB7)	63	20T2R		01/97-02/01	DG-101		11V				4
2.0 TDiC	77	20T2N		11/98-10/00	DG-101		11V				4
CIVIC VII (00-05)											
1.3 IMA	61	LDA1-MF3(IMA 83/90)		01/04-09/05	SK16PR-L11	3395	1.1	-	IK16TT	IK16TT	4
1.4 (ES4)	66	D14Z5		12/00-09/05	KJ16CR-L11	3132	1.1	K16TT	IK16TT	IK16TT	4
1.4 i	55	D14Z6		02/01-09/05	KJ16CR-L11	3132	1.1	K16TT	IK16TT	IK16TT	4
1.4 iS (EP1)	66	D14Z5; D14Z6		02/01-09/05	KJ16CR-L11	3132	1.1	K16TT	IK16TT	IK16TT	4
1.6	81	D16V1		02/01-09/05	KJ16CR-L11	3132	1.1	K16TT	IK16TT	IK16TT	4
1.6 i	81	D16V1		02/01-12/05	KJ16CR-L11	3132	1.1	K16TT	IK16TT	IK16TT	4
1.7 CTDi	74	4EE-2		01/02-09/05	DG-302		11V				4
1.7 i	88	D17A8		05/01-12/05	KJ20CR-L11	3169	1.1	K20TT	IK20TT	IK20TT	4
1.7 i VTEC	92	D17A9		05/01-12/05	KJ20CR-L11	3169	1.1	K20TT	IK20TT	IK20TT	4
1.8	103	R18A1		02/01-09/05	SKJ20DR-M11S	3432	1.1	-	-	-	4
2.0	118	K20A3		10/03-09/05	SK22PR-M11S	3419	1.1	-	-	VK22G	4
2.0 i Sport	118	K20A3		09/01-09/05	SK22PR-M11S	3419	1.1	-	-	VK22G	4
2.0 Type-R	147	K20A2		09/01-09/05	SK22PR-M11S	3419	1.1	-	-	VK22G	4
CIVIC VIII Hatchback (05-)											
1.4	61/73	L13A7; L13Z1		01/06-	KJ20CR-L11	3169	1.1	K20TT	IK20TT	IK20TT	4
1.4	61	L13A7	OEM Optional	01/06-	SK20PR-L11	3443	1.1	-	IK20TT	IK20TT	4
1.4	73	L13Z1	OEM Optional	10/08-	SKJ20DR-M13	3401	1.3	-	IK20TT	IK20TT	4
1.8	103	R18A2		01/06-	SKJ20DR-M11S	3432	1.1	-	-	-	4
2.2 CTDi	103	N22A2		01/06-	DG-601		11V				4

Spark & Glow Plugs

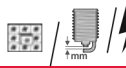







Application Tables







	KW					Standard				QTY	
HONDA <i>continued</i>											
CIVIC VIII Hatchback (05-) <i>continued</i>											
Type R	148	K20Z4		09/06-	SK22PR-M11S	3419	1.1	-	-	VK22G	4
CIVIC VIII Saloon (05-)											
1.3	85	L13A6		02/06-	VKH20	5618	1.1	-	-	IKH20TT	8
1.3 Hybrid	70/85	LDA2		01/06-	VKH20	5618	1.1	-	-	IKH20TT	8
1.6	84	R16A1		09/05-06/09	SKJ20DR-M11	3377	1.1	-	-	IK20TT	4
1.8	103	R18A1; R18A2		09/05-	SKJ20DR-M11S	3432	1.1	-	-	-	4
CONCERTO (89-96)											
1.4	66	D14A1		08/89-10/91	Q20PR-U11	3008	1.1	Q20TT	IQ20TT	IQ20TT	4
1.5 i 16V	66	D15B2		08/89-05/95	Q20PR-U11	3008	1.1	Q20TT	IQ20TT	IQ20TT	4
1.6	96	D16A9		10/89-10/92	Q20PR-U11	3008	1.1	Q20TT	IQ20TT	IQ20TT	4
1.6 16V	78	D16Z2		08/89-03/95	Q20PR-U11	3008	1.1	Q20TT	IQ20TT	IQ20TT	4
1.6 i 16V	82/90	D16A8; D16Z2		08/89-03/95	Q20PR-U11	3008	1.1	Q20TT	IQ20TT	IQ20TT	4
CR-V I (95-02)											
2.0	98	B20B;B20Z1		04/99-02/02	KJ16CR-L11	3132	1.1	K16TT	IK16TT	IK16TT	4
2.0	98	B20Z1	LPG / GPL	04/99-02/02	KJ20CR-U11	3451	1.1	K20TT	IK20TT	IK20TT	4
2.0 16V (RD1, RD3)	108	B20B;B20Z1		01/99-02/02	KJ16CR-L11	3132	1.1	K16TT	IK16TT	IK16TT	4
2.0 16V (RD1, RD3)	108	B20Z1	LPG / GPL	01/99-02/02	KJ20CR-U11	3451	1.1	K20TT	IK20TT	IK20TT	4
2.0 16V 4WD (RD1, RD3)	94	B20B3;B20Z3		10/95-01/99	KJ16CR-L11	3132	1.1	K16TT	IK16TT	IK16TT	4
CR-V II (01-06)											
2.0	110	K20A4		07/02-09/06	KJ20DR-M11	3374	1.1	-	-	IK20TT	4
2.2 CTDi	103	N22A2		02/05-09/06	DG-601		11V				4
2.4 Vtec 4WD (RD7)	118	K24A1		09/01-09/06	KJ20DR-M11	3374	1.1	-	-	IK20TT	4
CR-V III (06-)											
2.0 i 4WD	110	R20A2		01/07-04/10	KJ20DR-M11	3374	1.1	-	-	IK20TT	4
2.0 i 4WD	110	R20A2		04/10-	SKJ20DR-M11	3377	1.1	-	-	IK20TT	4
2.2 i-CTDi 4WD	103	N22A2		01/07-	DG-601		11V				4
2.4	125	K24A1		04/07-	KJ20DR-M11	3374	1.1	-	-	IK20TT	4
2.4 4WD	124	K24A; K24Z1		09/06-	KJ20DR-M11	3374	1.1	-	-	IK20TT	4
2.4 i-VTEC 4WD	118/122	K24Z1; K24Z4		10/06-	SKJ20DR-M11	3377	1.1	-	-	IK20TT	4
CRX I (83-87)											
1.5 i (AF)	74	EW3		10/83-11/86	W20EXR-U11	3067	1.1	W20TT	IW20TT	IW20TT	4
1.6 i 16V (AS)	92	ZC1		03/86-10/87	Q20PR-U11	3008	1.1	Q20TT	IQ20TT	IQ20TT	4
CRX II (87-92)											
1.6 i 16V	79	D16A6		10/87-05/88	Q20PR-U11	3008	1.1	Q20TT	IQ20TT	IQ20TT	4
1.6 i 16V (ED9)	91/96	D16A9; D16Z5		10/87-02/92	Q20PR-U11	3008	1.1	Q20TT	IQ20TT	IQ20TT	4
1.6 i 16V Vtec (EE8)	110	B16A1		10/89-02/92	K20PR-L11	3144	1.1	K20TT	IK20TT	IK20TT	4
CRX III (92-98)											
1.6 ESi (EH6)	92	D16Z6		03/92-12/98	K20PR-L11	3144	1.1	K20TT	IK20TT	IK20TT	4
1.6 i VTi (EG2)	118	B16A2		03/92-12/98	K20PR-L11	3144	1.1	K20TT	IK20TT	IK20TT	4
CR-Z (10-)											
1.5 Hybrid	84	LEA1		06/10-	DK20PR-D13	3476	1.3	-	-	VFK20F	4
ELEMENT (02-11)											
2.4 Vtec	118	K24A6		07/02-12/11	SKJ20DR-M11	3377	1.1	-	-	IK20TT	4
2.4 Vtec 4x4	118	K24A6		07/02-12/11	SKJ20DR-M11	3377	1.1	-	-	IK20TT	4
ELYSION (04-)											
3.0 i-VTEC	184	J30A4		05/04-	SKJ20DR-M11	3377	1.1	-	-	IK20TT	6
3.5 i-VTEC	221			05/04-	SKJ20DR-M11	3377	1.1	-	-	IK20TT	6
FR-V (04-)											
1.7	92	D17A2		08/04-01/07	KJ20CR-L11	3169	1.1	K20TT	IK20TT	IK20TT	4
1.7 Vtec 4x4	92	D17A2		08/04-09/06	KJ20CR-L11	3169	1.1	K20TT	IK20TT	IK20TT	4
1.8	103	R18A1		01/07-	SKJ20DR-M11S	3432	1.1	-	-	-	4
2.0	110/114	K20A4		08/04-01/07	KJ20DR-M11	3374	1.1	-	-	IK20TT	4
2.0 4x4	114	K20A4		08/04-09/06	KJ20DR-M11	3374	1.1	-	-	IK20TT	4
2.2 i CTDi	103	N22A1		07/05-	DG-601		11V				4
HR-V (99-)											
1.6 16V	77	D16W1(105)		03/99-09/05	KJ16CR-L11	3132	1.1	K16TT	IK16TT	IK16TT	4
1.6 16V 4WD	77/91	D16W1(105); D16W5(125)		03/99-09/05	KJ16CR-L11	3132	1.1	K16TT	IK16TT	IK16TT	4
INSIGHT (00-06)											
1.0 Hybrid	56	ECA1		04/00-12/06	VKH20	5618	1.1	-	-	IKH20TT	3
1.0 Vtec	50	ECA1		04/00-10/04	VKH20	5618	1.1	-	-	IKH20TT	3
INSIGHT (09-)											
1.3 Hybrid	65/73	LDA3		04/09-	VFKH20	5655	1.1	-	-	IKH20TT	4
INSPIRE (98-03)											
3.2	191	J32A		09/98-08/03	PKJ20CR-M11	3392	1.1	-	-	IK20TT	6







Spark & Glow Plugs

Application Tables

KW	KW	KW	KW	KW	Standard			Twin Tip			QTY
					Standard	Standard	Standard	Twin Tip	Twin Tip	Twin Tip	
HONDA continued											
INSPIRE (07-12)											
3.5	182	J35A		12/07-09/12	VXUHC22G	5652	0.9	-	-	VXUHC22G	6
INTEGRA (85-93)											
1.5	63	D15A1		10/85-08/89	W20EXR-U	3066	0.8	W20TT	IW20TT	IW20TT	4
1.6 (DA1, DA3)	88	D16A2;D16A3		03/86-08/89	Q20PR-U11	3008	1.1	Q20TT	IQ20TT	IQ20TT	4
INTEGRA (93-01)											
1.8 Type-R	140	B18C6		11/97-10/01	PK22PR-L11S	3284	1.1	-	-	VK22G	4
INTEGRA (02-)											
2.0 16V Type-R	162	K20Z1		02/02-	SK22PR-M11S	3419	1.1	-	-	VK22G	4
JAZZ I (83-86)											
45 1.2	33	ER2		02/84-10/86	W16EXR-U11	3032	1.1	W16TT	IW16TT	IW16TT	4
55 1.2	40	ER4		09/84-10/86	W16EXR-U11	3032	1.1	W16TT	IW16TT	IW16TT	4
56 1.2	41	ER1		10/83-10/86	W16EXR-U11	3032	1.1	W16TT	IW16TT	IW16TT	4
JAZZ II (02-08)											
1.2	57	L12A1		03/02-07/08	K20PR-U11	3121	1.1	K20TT	IK20TT	IK20TT	4
1.3	61	L13A1		03/02-07/08	K20PR-U11	3121	1.1	K20TT	IK20TT	IK20TT	4
1.3 iDSi	63	L13A1		03/02-09/07	K20PR-U11	3121	1.1	K20TT	IK20TT	IK20TT	8
JAZZ III (08-)											
1.2	66	L12B1		07/08-	DK20PR-D13	3476	1.3	-	-	VFK20F	4
1.3 HYBRID	65	LDA3		04/11-	VFKH20	5655	1.1	-	IKH20TT	IKH20TT	4
1.3 i	73	L13Z1		07/08-	DK20PR-D13	3476	1.3	-	-	VFK20F	4
1.4	74	L13Z1		11/08-	DK20PR-D13	3476	1.3	-	-	VFK20F	4
1.5 Flexfuel	88	L15A3		07/08-	SKJ20DR-M13	3401	1.3	-	IK20TT	IK20TT	4
1.5 i	88	L15A3; L15A7		07/08-	SKJ20DR-M13	3401	1.3	-	IK20TT	IK20TT	4
JAZZ Saloon (03-)											
1.3	63	L13A1		05/03-	K20PR-U11	3121	1.1	K20TT	IK20TT	IK20TT	8
LAGREAT (98-02)											
3.5 EX	151	J35A		11/98-06/02	SKJ20DR-M11	3377	1.1	-	IK20TT	IK20TT	6
LEGEND I (86-90)											
2.5 i (HS)	110/127	C25A1; C25A2		01/86-06/88	Q20PR-U11	3008	1.1	Q20TT	IQ20TT	IQ20TT	6
2.7 i 24V	124	C27A1		10/87-12/90	Q20PR-U11	3008	1.1	Q20TT	IQ20TT	IQ20TT	6
2.7 i 24V (KA4)	124	C27A1		01/88-12/90	Q20PR-U11	3008	1.1	Q20TT	IQ20TT	IQ20TT	6
LEGEND II (91-96)											
3.2 i 24V	151	C32A2		01/91-02/96	PK20PR-L11	3142	1.1	-	IK20TT	IK20TT	6
LEGEND III (96-)											
3.5 i 24V	151	C35A2		02/96-	PK20PR-L11	3142	1.1	-	IK20TT	IK20TT	6
LEGEND IV (06-)											
3.5 V6 4WD	217	C35A8; J35A8		05/06-	SKJ20DR-M11	3377	1.1	-	IK20TT	IK20TT	6
3.7 VTEC V6 4WD	217	J37A2; J37A3		07/08-	SXU22HCR11S	3461	1.1	-	-	VXUHC22G	6
LIFE (03-)											
0.7 iDSi	38	P07A		09/03-	IK20G	5352	1.1	-	-	VK20G	3
0.7 iDSi Turbo	47	P07AT		09/03-	IK20G	5352	1.1	-	-	VK20G	3
LOGO (99-02)											
1.3	48	D13B7		03/99-03/02	KJ16CR-L11	3132	1.1	K16TT	IK16TT	IK16TT	4
N (68-74)											
600	31	N600E		05/68-08/74	W24ESR-U	4033	0.8	-	-	-	2
NSX (90-05)											
3.0 24V Vtec	201	C30A3		03/95-09/05	PK20PR-L11	3142	1.1	-	IK20TT	IK20TT	6
3.0 24V Vtec (NA1)	201	C30A3		06/90-09/05	PK20PR-L11	3142	1.1	-	IK20TT	IK20TT	6
3.0 24V Vtec Automatic	188	C30A4		03/95-09/05	PK20PR-L11	3142	1.1	-	IK20TT	IK20TT	6
3.0 24V Vtec Automatik (NA1)	188	C30A4		06/90-09/05	PK20PR-L11	3142	1.1	-	IK20TT	IK20TT	6
3.2 24V Vtec	206	C32B2		01/97-09/05	PK20PR11	3168	1.1	K20TT	IK20TT	IK20TT	6
3.2 24V Vtec (NA2)	206	C32B2		01/97-09/05	PK20PR11	3168	1.1	K20TT	IK20TT	IK20TT	6
ODYSSEY (RC1, RC2) (13-)											
2.4 i-VTEC	140			12/13-	DXE22HQR-D11S	3492	1.1	-	-	DXE22HQR-D11S	4
2.4 i-VTEC 4WD	140			12/13-	DXE22HQR-D11S	3492	1.1	-	-	DXE22HQR-D11S	4
ODYSSEY (02-)											
2.3	110	F23A		07/02-09/03	KJ16CR-L11	3132	1.1	K16TT	IK16TT	IK16TT	4
2.3 4x4	110	F23A		07/02-09/03	KJ16CR-L11	3132	1.1	K16TT	IK16TT	IK16TT	4
2.4	118/140	K24A4; K24A5		10/03-10/08	SKJ20DR-M11	3377	1.1	-	IK20TT	IK20TT	4
2.4 i-VTEC	127	K24A (Absolute)		11/08-	DXU22HCR-D11S	3483	1.1	-	-	DXU22HCR-D11S	4
2.4 i-VTEC	127	K24A (Exc. Absolute)		11/08-	SXU22HCR11S	3461	1.1	-	-	VXUHC22G	4
2.4 i-VTEC 4x4	127	K24A (Absolute)		11/08-	DXU22HCR-D11S	3483	1.1	-	-	DXU22HCR-D11S	4
2.4 i-VTEC 4x4	127	K24A (Exc. Absolute)		11/08-	SXU22HCR11S	3461	1.1	-	-	VXUHC22G	4
3.5	171/182	J35A; J35A8		07/02-	SKJ20DR-M11	3377	1.1	-	IK20TT	IK20TT	6



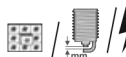



	KW					Standard			Twin Tip		QTY
HONDA <i>continued</i>											
PILOT (05-08)											
3.5 4WD	195	J35A9		10/05-07/08	SKJ20DR-M11	3377	1.1	-	IK20TT	IK20TT	6
PRELUDE I (78-82)											
1.6	59	EL		11/78-10/82	W16EPR-U	3021	0.8	W16TT	IW16TT	IW16TT	4
PRELUDE II (83-87)											
1.8 EX	74/77	ET2; ET4		11/83-04/87	W20EXR-U	3066	0.8	W20TT	IW20TT	IW20TT	4
PRELUDE III (86-92)											
2.0 (BA4)	84	B20A4		08/87-01/92	Q20PR-U11	3008	1.1	Q20TT	IQ20TT	IQ20TT	4
2.0 EX (BA4)	80	B20A3		04/87-01/92	Q20PR-U11	3008	1.1	Q20TT	IQ20TT	IQ20TT	4
2.0 i EX 16V	110	B20A7		10/87-12/90	Q20PR-U11	3008	1.1	Q20TT	IQ20TT	IQ20TT	4
2.0 i EX 16V (BA2)	101	B20A1		04/86-12/87	Q20PR-U11	3008	1.1	Q20TT	IQ20TT	IQ20TT	4
2.0 i EX 16V (BA4)	103	B20A9		04/90-01/92	Q20PR-U11	3008	1.1	Q20TT	IQ20TT	IQ20TT	4
2.0 i EX 16V (BA4) CAT	101	B20A5		04/87-01/92	Q20PR-U11	3008	1.1	Q20TT	IQ20TT	IQ20TT	4
PRELUDE IV (92-96)											
2.0 i 16V (BB3)	98	F20A4		02/92-09/96	KJ20CR-L11	3169	1.1	K20TT	IK20TT	IK20TT	4
2.2 i 16V Vtec (BB1)	136	H22A2		02/93-09/96	PKJ20CR-L11	3247	1.1	-	IK20TT	IK20TT	4
2.3 i 16V (BB2)	118	H23A2		02/92-09/96	KJ20CR-L11	3169	1.1	K20TT	IK20TT	IK20TT	4
PRELUDE V (96-00)											
2.0 16V (BB9)	98	F20A4		10/96-10/00	KJ20CR-L11	3169	1.1	K20TT	IK20TT	IK20TT	4
2.2 16V	147	H22A5		10/96-10/00	PKJ20CR-L11	3247	1.1	-	IK20TT	IK20TT	4
2.2 16V (BB6, BB8)	136	H22A5		10/96-10/00	PKJ20CR-L11	3247	1.1	-	IK20TT	IK20TT	4
QUINTET (80-84)											
1.6 EX	59	EL		02/80-12/84	W16EPR-U	3021	0.8	W16TT	IW16TT	IW16TT	4
RIDGELINE (05-)											
3.5 4x4	188	J35A9		03/05-	SKJ20DR-M11	3377	1.1	-	IK20TT	IK20TT	6
S2000 (99-)											
2.0	177	F20C VTEC		06/99-11/05	PK22PR-L11S	3284	1.1	-	-	VK22G	4
2.0 Vtec	170/ 184	F20C1; F20C3		03/99-11/05	PK22PR-L11S	3284	1.1	-	-	VK22G	4
2.2 Vtec	176	F22C1		10/03-06/09	PK22PR-L11S	3284	1.1	-	-	VK22G	4
SHUTTLE (94-04)											
2.2 16V	110	F22B8		10/94-02/98	KJ20CR-L11	3169	1.1	K20TT	IK20TT	IK20TT	4
2.3 16V	110	F23A7		10/97-06/04	KJ22CR-L11	3348	1.1	-	-	VK22	4
STREAM (01-)											
1.7 16V	92	D17A2		05/01-09/05	KJ20CR-L11	3169	1.1	K20TT	IK20TT	IK20TT	4
2.0 16V	115	K20A1		05/01-09/05	KJ20DR-M11	3374	1.1	-	IK20TT	IK20TT	4
HUMMER											
HUMMER H1 (92-)											
6.5 D	125			01/92-	DG-175		10.5V				8
6.5 Turbo D	143			01/92-	DG-175		10.5V				8
HUMMER H2 (02-)											
6.0	237	LQ4		09/04-	PTJ16R15	5077	1.5	-	IT16TT	IT16TT	8
6.0 AWD	232	LQ4		09/02-09/04	PTJ16R15	5077	1.5	-	IT16TT	IT16TT	8
HUMMER H3 (05-)											
3.5	162	L52		04/05-	PT16VR13	5068	1.3	TV16TT	ITV16TT	ITV16TT	5
5.3 V8 AWD	224	LH8		10/08-	IT16	5325	1.1	-	IT16TT	IT16TT	8
HYUNDAI											
ACCENT / SOLARIS (10-)											
1.4	79/80	G4FA		11/10-	XU22HDR9	3445	0.9	XUH22TT	-	VXUH22	4
1.6	90/91	G4FC		11/10-	XU22HDR9	3445	0.9	XUH22TT	-	VXUH22	4
ACCENT I (94-00)											
1.3	44/55	G4EH44; G4EH62		10/94-01/00	K16PR-U11	3130	1.1	K16TT	IK16TT	IK16TT	4
1.3 i 12V	62	G4EH62		10/94-01/00	K16PR-U11	3130	1.1	K16TT	IK16TT	IK16TT	4
1.5 i 12V	65	G4EK-88		10/94-01/00	K16PR-U11	3130	1.1	K16TT	IK16TT	IK16TT	4
1.5 i 16V	73	G4FK-99		10/95-01/00	K16PR-U11	3130	1.1	K16TT	IK16TT	IK16TT	4
1.5 i 16V	73	G4FK-99	OEM Optional	12/95-01/00	K20PR-U11	3121	1.1	K20TT	IK20TT	IK20TT	4
ACCENT II (99-05)											
1.3	55/ 61/ 62/ 63	G4EA(84); G4EH62; G4EA(84); G4EH55; G4EH62		01/00-01/03	K16PR-U11	3130	1.1	K16TT	IK16TT	IK16TT	4
1.5	66/75	G4EK-90; G4FK-102; G4EK-90		01/00-01/03	K16PR-U11	3130	1.1	K16TT	IK16TT	IK16TT	4
1.5 CRDi	60	D3EA		01/02-11/05	DG-173		11V				3
1.6	77	G4ED(105)		12/02-11/05	K16PR-U11	3130	1.1	K16TT	IK16TT	IK16TT	4
1.6	77	G4ED(105)	OEM Optional	12/02-11/05	K20PR-U	3145	0.8	K20TT	IK20TT	IK20TT	4
ACCENT III (05-10)											
1.4 GL	71	G4EE		11/05-11/10	K16PR-U11	3130	1.1	K16TT	IK16TT	IK16TT	4
1.4 GL	71	G4EE	OEM Optional	11/05-11/10	K20PR-U	3145	0.8	K20TT	IK20TT	IK20TT	4
1.5 CRDi GLS	81	D4FA		04/06-11/10	DG-602		11V				4







	KW				 Standard			 Twin Tip			 QTY
HYUNDAI <i>continued</i>											
ACCENT III (05-10) <i>continued</i>											
1.6 GLS	82	G4EB(112)		11/05-11/10	K16PR-U11	3130	1.1	K16TT	IK16TT	IK16TT	4
ATOS (98-)											
1.0 i	40/ 41/ 43	G4HC; G4HC-E		02/98-03/08	K16PR-U11	3130	1.1	K16TT	IK16TT	IK16TT	4
1.1	43/ 45/ 46	G4HD; G4HG		08/03-03/08	K16PR-U11	3130	1.1	K16TT	IK16TT	IK16TT	4
ATOS Prime (99-)											
1.0 i	40/43	G4HC; G4HC-E		08/99-	K16PR-U11	3130	1.1	K16TT	IK16TT	IK16TT	4
1.1	43/46	G4HD; G4HG		06/03-	K16PR-U11	3130	1.1	K16TT	IK16TT	IK16TT	4
COUPE (96-02)											
1.6 16V	85	G4GR		03/98-04/02	K16PR-U11	3130	1.1	K16TT	IK16TT	IK16TT	4
1.6 i 16V	84	4G61		12/96-04/02	K16PR-U11	3130	1.1	K16TT	IK16TT	IK16TT	4
2.0 16V	102	G4GF		08/96-04/02	K16PR-U11	3130	1.1	K16TT	IK16TT	IK16TT	4
COUPE (01-09)											
1.6 16V	77/79	G4ED-G		03/02-08/06	K16PR-U11	3130	1.1	K16TT	IK16TT	IK16TT	4
1.6 16V	77/79	G4ED-G		09/06-08/09	SK16PR-L11	3395	1.1	-	IK16TT	IK16TT	4
2.0	100/ 102	G4GC-G		08/01-12/06	K16PR-U11	3130	1.1	K16TT	IK16TT	IK16TT	4
2.0	100/ 102	G4GC-G		09/06-08/09	SK16PR-L11	3395	1.1	-	IK16TT	IK16TT	4
2.0 GLS	105	G4GC-G		02/03-12/06	K16PR-U11	3130	1.1	K16TT	IK16TT	IK16TT	4
2.0 GLS	105	G4GC-G		09/06-08/09	SK16PR-L11	3395	1.1	-	IK16TT	IK16TT	4
2.7 V6	123	G6BA-G-167		03/02-12/06	PK16PR-L11	3275	1.1	-	IK16TT	IK16TT	6
2.7 V6	121	2.7L-DELTA		01/07-08/09	SK16PR-L11	3395	1.1	-	IK16TT	IK16TT	6
ELANTRA (00-06)											
1.6	66/ 77/ 79	G4ED-G; G4GR		06/00-07/06	K16PR-U11	3130	1.1	K16TT	IK16TT	IK16TT	4
1.6 CRDi	85	D4FB		02/06-07/06	DG-602		11V				4
1.8	97	G4GM-132		06/00-07/06	K16PR-U11	3130	1.1	K16TT	IK16TT	IK16TT	4
2.0	102/ 104/ 105	G4GC-G		06/00-07/06	K16PR-U11	3130	1.1	K16TT	IK16TT	IK16TT	4
2.0 CRDi	83	D4EA		04/01-07/06	DG-173		11V				4
ELANTRA (05-11)											
1.6 CVVT	90	G4FC		02/09-06/11	XU22HDR9	3445	0.9	XUH22TT	-	VXUH22	4
1.6 CVVT	90	G4FC	14 mm diameter+	06/06-01/09	KJ16CR-U11	3311	1.1	K16TT	IK16TT	IK16TT	4
2.0 CVVT	105	G4GC		06/06-12/06	K16PR-U11	3130	1.1	K16TT	IK16TT	IK16TT	4
2.0 CVVT	105	G4GC		09/06-06/11	SK16PR-L11	3395	1.1	-	IK16TT	IK16TT	4
ELANTRA (11-)											
1.6	96/97	G4FG		06/11-	XU22HDR9	3445	0.9	XUH22TT	-	VXUH22	4
1.6 CRDi	94	D4FB		02/11-	DG-602		11V				4
EQUUS / CENTENNIAL (09-)											
4.6 V8	274			03/09-	VFKH16	5654	1.1	-	IKH16TT	IKH16TT	8
GALLOPER (91-98)											
2.5 TD	62	4D56T		08/91-07/98	DG-198		11V				4
2.5 TD intercooler	70	4D56T		08/91-07/98	DG-174		11V				4
GALLOPER (98-03)											
2.5 Tci D	77	D4BH		08/98-12/03	DG-172		11V				4
2.5 TD	65	D4BA		08/98-12/03	DG-301		11V				4
2.5 TD intercooler	73	D4BH		08/98-12/03	DG-198		11V				4
3.0 V6	104	G6A		08/98-06/02	W16EXR-U11	3032	1.1	W16TT	IW16TT	IW16TT	6
GENESIS (08-)											
2.0 T	157/ 202/ 204	G4KF		01/08-	VFKH20	5655	1.1	-	IKH20TT	IKH20TT	4
3.8 V6	213/ 223/ 246/ 260	G6DA; G6DJ		12/08-	VXUH22I	5656	0.9	-	-	VXUH22I	6
GETZ (02-09)											
1.1	46/49	1.1L-EPSILON; G4H46		09/02-06/09	K16PR-U11	3130	1.1	K16TT	IK16TT	IK16TT	4
1.3	63	G4EA(85)		09/03-03/04	K16PR-U11	3130	1.1	K16TT	IK16TT	IK16TT	4
1.3 i	60	G4EH60		09/02-03/04	K16PR-U11	3130	1.1	K16TT	IK16TT	IK16TT	4
1.4 i	71	1.4L-ALPHA		11/06-	K16PR-U11	3130	1.1	K16TT	IK16TT	IK16TT	4
1.5 CRDi	60	D3EA		03/03-09/05	DG-173		11V				3
1.5 CRDi	65	D4FA		08/05-06/09	DG-602		11V				4
1.5 CRDi GLS	75	D4FA		07/04-08/05	DG-173		11V				4
1.5 CRDi GLS	81	D4FA		08/05-06/09	DG-602		11V				4



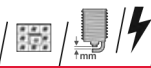

	KW								QTY		
HYUNDAI <i>continued</i>											
GETZ (02-09) <i>continued</i>											
1.6	77/78	G4ED-G		09/02-08/06	K16PR-U11	3130	1.1	K16TT	IK16TT	IK16TT	4
1.6	78	G4ED-G		09/06-	SK16PR-L11	3395	1.1	-	IK16TT	IK16TT	4
GRANDEUR / XG (98-05)											
30	138	G6AT;G6AT(IF); G6CT		12/98-12/05	PK16PR-L11	3275	1.1	-	IK16TT	IK16TT	6
250	120	G6AV;G6BV		12/98-12/05	PK16PR-L11	3275	1.1	-	IK16TT	IK16TT	6
350	145	G6CU		10/02-12/05	PK16PR-L11	3275	1.1	-	IK16TT	IK16TT	6
GRANDEUR (05-)											
2.2 CRDi	110/ 114	D4EB		06/06-	DG-173		11V				4
2.7	141	2.7L-MU		05/06-	VKH16	5617	1.1	-	IKH16TT	IKH16TT	6
3.3	173/ 191	G6DB		04/05-	SK16PR-L11	3395	1.1	-	IK16TT	IK16TT	6
3.8	195	G6DA		11/10-	SK16PR-L11	3395	1.1	-	IK16TT	IK16TT	6
GRANDEUR (11-)											
2.7	141	2.7L-MU		06/11-	VKH16	5617	1.1	-	IKH16TT	IKH16TT	4
H-1 / STAREX (97-07)											
2.4	82	G4CSS		06/97-04/04	W20EPR-U	3047	0.8	W20TT	IW20TT	IW20TT	4
2.4	82	G4CSS		03/00-04/04	W20EPR-U11	3049	1.1	W20TT	IW20TT	IW20TT	4
2.4 4WD	82	G4CSS		02/98-07/01	W16EXR-U11	3032	1.1	W16TT	IW16TT	IW16TT	4
2.4 4WD	82	G4CSS	OEM Optional	02/98-07/01	W20EPR-U	3047	0.8	W20TT	IW20TT	IW20TT	4
2.5 CRDi	81/ 103	D4CB		07/01-12/07	DG-189		11V				4
2.5 D	57	D4BF		10/97-04/04	DG-172		11V				4
2.5 D	73	D4BH		06/00-10/05	DG-198		11V				4
2.5 Tci	73/74	D4BH		10/97-12/07	DG-198		11V				4
2.5 TD	59/74	D4BF; D4BH		03/00-04/04	DG-172		11V				4
2.5 TD	59/73	D4BF; D4BH		03/00-04/04	DG-198		11V				4
2.5 TD 4WD	59/ 73/ 74	D4BF; D4BH		02/98-04/04	DG-198		11V				4
H-1 (08-)											
2.5 CRDi	81/ 85/ 100/ 120/ 125	D4CB; D4CB-L; D4CB-W		07/08-	DG-189		11V				4
H100 (93-04)											
2.4	82/ 84/ 90	G4CSAAS		07/93-03/00	W20EPR-U11	3049	1.1	W20TT	IW20TT	IW20TT	4
2.5 D	55/57	D4BA; D4BX		07/93-03/00	DG-172		11V				4
2.5 TD	59	D4BF		07/93-03/00	DG-172		11V				4
2.5 TD	59	D4BF		07/93-03/00	DG-198		11V				4
HIGHWAY VAN (00-)											
2.0 16V	100	G4JP		03/00-02/04	K16PR-U11	3130	1.1	K16TT	IK16TT	IK16TT	4
2.7 V6 24V	125	G6BA		03/00-02/04	K16PR-U11	3130	1.1	K16TT	IK16TT	IK16TT	6
2.7 V6 24V	125	G6BA	OEM Optional	03/00-02/04	PK16PR-L11	3275	1.1	-	IK16TT	IK16TT	6
i10 (07-)											
1.0	51	G3LA		01/11-	XUH20TTi	7006	0.8	XUH20TTi	-	VXUH20i	3
1.1	51	G4HG		04/11-11/13	K16PR-U	3191	0.8	K16TT	IK16TT	IK16TT	4
1.1	48/49	G4HG		12/07-11/10	K16PR-U11	3130	1.1	K16TT	IK16TT	IK16TT	4
1.1 CRDi	55	D3FA		01/08-	DG-602		11V				3
1.2	57/63	G4LA		11/08-	SXU22HDR8	3441	0.8	-	-	VXUH22	4
i10 (13-)											
1.0 LPG	51	B3LA		02/14-	XUH20TTi	7006	0.8	XUH20TTi	-	VXUH20i	3
1.0	49	G3LA		12/13-	XUH20TTi	7006	0.8	XUH20TTi	-	VXUH20i	3
1.2	64	G4LA		12/13-	XUH20TTi	7006	0.8	XUH20TTi	-	VXUH20i	4
1.2	64	G4LA	OEM Optional	12/13-	IXUH20i			-	-	VXUH20i	4
i20 (08-)											
1.1 CRDi	55	D3FA		03/12-	DG-602		11V				3
1.2	57	G4LA		09/08-	SXU22HDR8	3441	0.8	-	-	VXUH22	4
1.2	63	G4LA		03/12-	XUH20TTi	7006	0.8	XUH20TTi	-	VXUH20i	4
1.2	63	G4LA	OEM Optional	03/12-	IXUH20i			-	-	VXUH20i	4
1.4	74	G4FA		09/08-	XU22HDR9	3445	0.9	XUH22TT	-	VXUH22	4
1.4 CRDi	55/66	D4FC		08/08-	DG-602		11V				4
1.6	93	G4FC		09/08-	XU22HDR9	3445	0.9	XUH22TT	-	VXUH22	4
1.6 CRDi	85/94	D4FB		09/08-	DG-602		11V				4
i30 (07-12)											
1.4	77/80	G4FA		02/09-06/12	XU22HDR9	3445	0.9	XUH22TT	-	VXUH22	4
1.4	77/80	G4FA	14 mm diameter+	10/07-01/09	KJ16CR-U11	3311	1.1	K16TT	IK16TT	IK16TT	4

Spark & Glow Plugs

Application Tables









	KW					Standard		Twin Tip			QTY
HYUNDAI <i>continued</i>											
i30 (07-12) <i>continued</i>											
1.6	85/90/93	G4FC		02/09-06/12	XU22HDR9	3445	0.9	XUH22TT	-	VXUH22	4
1.6	85/90/93	G4FC	14 mm diameter+	02/08-01/09	KJ16CR-U11	3311	1.1	K16TT	IK16TT	IK16TT	4
1.6 CRDi	66/85	D4FB		10/07-11/11	DG-173		11V				4
1.6 CRDi	66/85/94	D4FB		02/08-06/12	DG-602		11V				4
2.0	105	G4GC; G4GC-G		10/07-06/12	SK16PR-L11	3395	1.1	-	IK16TT	IK16TT	4
2.0 CRDi	103	D4EA		10/07-06/12	DG-173		11V				4
i30 (11-)											
1.4	73	G4FA		12/11-	XU22HDR9	3445	0.9	XUH22TT	-	VXUH22	4
1.4 CRDi	66	D4FC		12/11-	DG-602		11V				4
1.6	88/95	MPI		06/12-	VXUH20I			-	-	VXUH20I	4
1.6	88/95	G4FC; GDI		01/12-	XU22HDR9	3445	0.9	XUH22TT	-	VXUH22	4
1.6 CRDi	81/94	D4FB; D4FB-5P		06/12-	DG-602		11V				4
1.6 GDI	95/99	G4FD; MPI		12/11-	VXUH20I			-	-	VXUH20I	4
1.6 GDI	95	GDI		12/11-	XU22HDR9	3445	0.9	XUH22TT	-	VXUH22	4
i30 Coupe (13-)											
1.6 CRDi	94	D4FB		05/13-	DG-602		11V				4
i40 (11-)											
1.6 GDI	99	G4FD		07/11-	VXUH20I			-	-	VXUH20I	4
2.0 GDI	130/131	G4NC		07/11-	VXUH22I	5656	0.9	-	-	VXUH22I	4
ix20 (10-)											
1.4	66	G4FA		11/10-	XU22HDR9	3445	0.9	XUH22TT	-	VXUH22	4
1.4 CRDi	57/66	D4FC-M		11/10-	DG-602		11V				4
1.6	92	G4FC		11/10-	XU22HDR9	3445	0.9	XUH22TT	-	VXUH22	4
1.6 CRDi	85/94	D4FB		06/11-	DG-602		11V				4
ix35 (09-)											
1.6	99	G4FD		11/10-	VXUH20I			-	-	VXUH20I	4
2.0	120	G4KD		01/10-	K16HPR-U11	6076	1.1	KH16TT	IKH16TT	IKH16TT	4
2.0 4WD	120	G4KD		01/10-	K16HPR-U11	6076	1.1	KH16TT	IKH16TT	IKH16TT	4
2.0 CVT 4WD	122	THETA 2 MPI		08/09-	K16HPR-U11	6076	1.1	KH16TT	IKH16TT	IKH16TT	4
2.0 CVT 4WD	122	G4KD; G4NC	Eng: NU MPI/GDI>	08/09-	VXUH22I	5656	0.9	-	-	VXUH22I	4
2.0 GDi	122	THETA 2 MPI		08/13-	K16HPR-U11	6076	1.1	KH16TT	IKH16TT	IKH16TT	4
2.0 GDi	122	G4NC	Eng: NU MPI/GDI>	08/13-	VXUH22I	5656	0.9	-	-	VXUH22I	4
2.0 GDi 4WD	122	THETA 2 MPI		08/13-	K16HPR-U11	6076	1.1	KH16TT	IKH16TT	IKH16TT	4
2.0 GDi 4WD	122	G4NC	Eng: NU MPI/GDI>	08/13-	VXUH22I	5656	0.9	-	-	VXUH22I	4
2.4 DCVT-I 4WD	128	G4KE		07/10-12/13	K16HPR-U11	6076	1.1	KH16TT	IKH16TT	IKH16TT	4
ix55 (08-)											
3.8 V6 4WD	194			01/11-	SK16PR-L11	3395	1.1	-	IK16TT	IK16TT	6
LANTRA I (90-95)											
1.5 i.e.	63	G4DJJA;G4DJJE	OEM Optional	10/90-11/95	W20EPR-U11	3049	1.1	W20TT	IW20TT	IW20TT	4
1.6 i.e. 16V	78/84	G4CR		10/90-11/95	W20EPR-U11	3049	1.1	W20TT	IW20TT	IW20TT	4
1.8 i.e. 16V	93	G4CN		06/92-11/95	W20EPR-U11	3049	1.1	W20TT	IW20TT	IW20TT	4
LANTRA II (95-00)											
1.5 12V	65	G4EK-88		12/96-10/00	K16PR-U11	3130	1.1	K16TT	IK16TT	IK16TT	4
1.5 12V	65	G4EK-88	OEM Optional	04/97-10/00	K20PR-U11	3121	1.1	K20TT	IK20TT	IK20TT	4
1.6 16V	84	G4GR		11/95-10/00	K16PR-U11	3130	1.1	K16TT	IK16TT	IK16TT	4
1.6 i	66	G4GR		11/95-10/00	K16PR-U11	3130	1.1	K16TT	IK16TT	IK16TT	4
1.8 16V	94	G4GM-128		11/95-10/00	K16PR-U11	3130	1.1	K16TT	IK16TT	IK16TT	4
1.9 D	50	DJY		03/98-10/00	DG-001		11V				4
2.0 16V	102	G4GF		08/96-10/00	K16PR-U11	3130	1.1	K16TT	IK16TT	IK16TT	4
MATRIX (01-10)											
1.5 CRDi	60/75	D3EA; D4FA		10/01-08/10	DG-173		11V				3
1.5 CRDi VGT	81	D4FA		08/05-08/10	DG-602		11V				4
1.6	66/76	G4(90); G4ED-G		06/01-08/06	K16PR-U11	3130	1.1	K16TT	IK16TT	IK16TT	4
1.6	76	G4ED-G		09/06-08/10	SK16PR-L11	3395	1.1	-	IK16TT	IK16TT	4
1.8	90	G4GB-G		06/01-08/06	K16PR-U11	3130	1.1	K16TT	IK16TT	IK16TT	4
PONY / EXCEL (89-95)											
1.3	43/49	G4DGJA; G4DGJE		10/89-01/95	W20EPR-U	3047	0.8	W20TT	IW20TT	IW20TT	4
1.3	48	G4DGJA;G4DGJE		12/92-09/94	W20EPR-U11	3049	1.1	W20TT	IW20TT	IW20TT	4
1.5	53	G4DJJA		01/90-01/95	W20EPR-U11	3047	0.8	W20TT	IW20TT	IW20TT	4
1.5	53	G4DJJA		10/89-01/95	W20EPR-U11	3049	1.1	W20TT	IW20TT	IW20TT	4
1.5 i	61/62	G4DJJE		10/89-01/95	W20EPR-U11	3049	1.1	W20TT	IW20TT	IW20TT	4

	KW								QTY
HYUNDAI <i>continued</i>									
PONY (74-82)									
1.4	50	HYUN04		01/82-12/82	W20EPR-U	3047 0.8	W20TT IW20TT	IW20TT	4
PONY (85-89)									
1.3	50	G4DGJA		10/85-09/89	W20EPR-U	3047 0.8	W20TT IW20TT	IW20TT	4
1.5	53	G4DJJAK; HYUN01		10/85-09/89	W20EPR-U11	3049 1.1	W20TT IW20TT	IW20TT	4
S COUPE (90-96)									
1.5 GS	57	G4DJ		03/90-12/92	W20EPR-U	3047 0.8	W20TT IW20TT	IW20TT	4
1.5 i	65	G4EK		04/92-05/96	K16PR-U11	3130 1.1	K16TT IK16TT	IK16TT	4
1.5 i	62	G4DJ; G15B		02/90-05/96	W20EPR-U11	3049 1.1	W20TT IW20TT	IW20TT	4
1.5 i Turbo	85	G4EK-TC		04/91-05/96	K20PR-U	3145 0.8	K20TT IK20TT	IK20TT	4
SANTA FÉ I (00-06)									
2.0	99	G4BP		08/01-03/06	W20EPR-U11	3049 1.1	W20TT IW20TT	IW20TT	4
2.0 CRDi	83	D4EA		08/01-03/06	DG-173	11V			4
2.0 CRDi 4x4	83/92	D4EA		04/01-03/06	DG-173	11V			4
2.0 CRDi All-wheel Drive	107	D4EA		11/03-02/06	DG-173	11V			4
2.2 CRDi	110	D4EB		10/05-03/06	DG-173	11V			4
2.2 CRDi 4x4	110	D4EB		10/05-03/06	DG-173	11V			4
2.4 16V	100/107	G4JS		02/01-03/06	P16PR11	3114 1.1	W16TT IW16TT	IW16TT	4
2.4 16V 4x4	100/107	G4JS		02/01-03/06	P16PR11	3114 1.1	W16TT IW16TT	IW16TT	4
2.7	139	G6EA		10/05-03/06	PK16PR-L11	3275 1.1	- IK16TT	IK16TT	6
2.7	129			08/04-03/06	VKH16	5617 1.1	- IKH16TT	IKH16TT	6
2.7	139	G6EA	OEM Optional	10/05-03/06	SK16PR-L11	3395 1.1	- IK16TT	IK16TT	6
2.7 4x4	132/139	G6EA		11/00-03/06	PK16PR-L11	3275 1.1	- IK16TT	IK16TT	6
2.7 4x4	132/139	G6EA	OEM Optional	11/00-03/06	SK16PR-L11	3395 1.1	- IK16TT	IK16TT	6
2.7 V6 4x4	127	G6BA-G		02/01-03/06	K16PR-U11	3130 1.1	K16TT IK16TT	IK16TT	6
2.7 V6 4x4	127	G6BA-G	OEM Optional	02/01-03/06	PK16PR-L11	3275 1.1	- IK16TT	IK16TT	6
3.5	147	G6CU		09/03-02/06	PK16PR-L11	3275 1.1	- IK16TT	IK16TT	6
3.5 4x4	147	G6CU		09/03-02/06	PK16PR-L11	3275 1.1	- IK16TT	IK16TT	6
SANTA FÉ II (06-)									
2.2 CRDi	102/114	D4EB		03/06-	DG-173	11V			4
2.2 CRDi 4x4	102/114	D4EB		03/06-	DG-173	11V			4
2.2 CRDi GLS	110	D4EB		03/06-	DG-173	11V			4
2.2 CRDi GLS 4x4	110	D4EB		03/06-	DG-173	11V			4
2.4	128	G4KE		11/10-	K16HPR-U11	6076 1.1	KH16TT IKH16TT	IKH16TT	4
2.4 4x4	128	G4KE		07/10-	K16HPR-U11	6076 1.1	KH16TT IKH16TT	IKH16TT	4
2.7	125	G6BA		03/06-09/09	VKH16	5617 1.1	- IKH16TT	IKH16TT	6
2.7 4x4	125	G6BA		03/06-09/09	VKH16	5617 1.1	- IKH16TT	IKH16TT	6
2.7 V6 GLS	139	G6EA		03/06-09/09	VKH16	5617 1.1	- IKH16TT	IKH16TT	6
2.7 V6 GLS 4x4	139	G6EA		03/06-09/09	VKH16	5617 1.1	- IKH16TT	IKH16TT	6
3.3 Dynamic 4x4	173	G6DB		03/06-	SK16PR-L11	3395 1.1	- IK16TT	IK16TT	6
SANTAMO (99-)									
2.0 16V	102	I4-DOHC		05/99-12/02	W16EXR-U11	3032 1.1	W16TT IW16TT	IW16TT	4
2.0 16V	102	I4-DOHC	OEM Optional	05/99-12/01	W20EPR-U11	3049 1.1	W20TT IW20TT	IW20TT	4
2.0 16V 4x4	102	I4-DOHC		05/99-12/02	W16EXR-U11	3032 1.1	W16TT IW16TT	IW16TT	4
2.0 16V 4x4	102	I4-DOHC	OEM Optional	05/99-12/01	W20EPR-U11	3049 1.1	W20TT IW20TT	IW20TT	4
SONATA II (88-93)									
1.8 i	70	G4CM		09/88-10/93	W20EPR-U11	3049 1.1	W20TT IW20TT	IW20TT	4
2.0 i	74/80	G4CP		09/88-10/93	W20EPR-U11	3049 1.1	W20TT IW20TT	IW20TT	4
2.0 i 16V	96	G4CPD		01/91-10/93	W20EPR-U11	3049 1.1	W20TT IW20TT	IW20TT	4
2.4 i	83	G4CS		09/88-08/91	W20EPR-U11	3049 1.1	W20TT IW20TT	IW20TT	4
3.0 i V6	107	G6AT		01/91-10/93	P16PR11	3114 1.1	W16TT IW16TT	IW16TT	6
SONATA III (93-98)									
1.8 i	72	G4CM		05/93-06/98	W20EPR-U11	3049 1.1	W20TT IW20TT	IW20TT	4
2.0 i	70/77	G4CP		06/94-06/98	W20EPR-U11	3049 1.1	W20TT IW20TT	IW20TT	4
2.0 i 16V	92/102	G4CP-D(139); G4CPD		09/94-06/98	W20EPR-U11	3049 1.1	W20TT IW20TT	IW20TT	4
3.0 i V6	107	G6AT		05/93-06/93	P16PR11	3114 1.1	W16TT IW16TT	IW16TT	6
SONATA IV (98-05)									
2.0 16V	96	G4JP-EG		10/01-11/04	K16PR-U11	3130 1.1	K16TT IK16TT	IK16TT	4
2.0 16V	100/106	G4JP-G		06/98-11/04	W20EPR-U11	3049 1.1	W20TT IW20TT	IW20TT	4
2.4 16V	105	G4DS		03/98-10/01	P16PR11	3114 1.1	W16TT IW16TT	IW16TT	4
2.5 V6 24V	118	G6AV		06/98-10/01	PK16PR-L11	3275 1.1	- IK16TT	IK16TT	6
2.7 V6	127	G6BA-G-173		10/01-11/04	PK16PR-L11	3275 1.1	- IK16TT	IK16TT	6

	KW				Standard			Twin Tip				QTY
HYUNDAI <i>continued</i>												
SONATA V (05-)												
2.0 CRDi	100/103/110	D4EA		02/06-	DG-173		11V					4
2.0 VVTi GLS	121	G4KD		01/08-	K16HPR-U11	6076	1.1	KH16TT	IKH16TT	IKH16TT		4
2.0 VVTi GLS	106	G4KA		05/05-04/08	K16PR-U11	3130	1.1	K16TT	IK16TT	IK16TT		4
2.4	119/125/127	G4KC; G4KE		12/07-	K16HPR-U11	6076	1.1	KH16TT	IKH16TT	IKH16TT		4
2.4	119	G4KC		01/05-12/07	K16PR-U11	3130	1.1	K16TT	IK16TT	IK16TT		4
3.3	171/173/184	G6DB		01/05-	SK16PR-L11	3395	1.1	-	IK16TT	IK16TT		6
SONATA VI (09-)												
2.0	110			01/09-	K16HPR-U11	6076	1.1	KH16TT	IKH16TT	IKH16TT		4
2.0 i	121	G4KD		01/11-	K16HPR-U11	6076	1.1	KH16TT	IKH16TT	IKH16TT		4
2.4	128/131	G4KC		01/09-	K16HPR-U11	6076	1.1	KH16TT	IKH16TT	IKH16TT		4
STELLAR (83-91)												
2.0 GSL	66	4G63		05/84-08/86	W20EPR-U	3047	0.8	W20TT	IW20TT	IW20TT		4
TERRACAN (01-06)												
2.9 CRDi 4WD	110/120	J3		12/01-12/06	DG-301		11V					4
3.5 i V6 4WD	143	G674		03/02-12/06	PK16PR-L11	3275	1.1	-	IK16TT	IK16TT		6
3.5 i V6 4WD	143	G674	OEM Optional	12/01-02/02	K16PR-U11	3130	1.1	K16TT	IK16TT	IK16TT		6
TIBURON (06-)												
1.6 CVVT	78	G4ED-G		10/06-	SK16PR-L11	3395	1.1	-	IK16TT	IK16TT		4
2.0 CVVT	105	G4GC		10/06-12/08	SK16PR-L11	3395	1.1	-	IK16TT	IK16TT		4
TRAJECT (00-08)												
2.0	103/104	G4GC-G		11/03-12/06	K16PR-U11	3130	1.1	K16TT	IK16TT	IK16TT		4
2.0	103/104	G4GC-G		09/06-07/08	SK16PR-L11	3395	1.1	-	IK16TT	IK16TT		4
2.0	100	G4JP-G		03/00-07/08	W20EPR-U11	3049	1.1	W20TT	IW20TT	IW20TT		4
2.0 CRDi	83	D4EA		04/01-07/08	DG-173		11V					4
2.7 V6	127	G6BA-G-173		03/04-06/07	K16PR-U11	3130	1.1	K16TT	IK16TT	IK16TT		6
2.7 V6	127	G6BA(172);G6BA-G-173	OEM Optional	09/00-06/07	PK16PR-L11	3275	1.1	-	IK16TT	IK16TT		6
TUCSON (04-10)												
2.0	104/105	G4GC		08/04-03/10	K16PR-U11	3130	1.1	K16TT	IK16TT	IK16TT		4
2.0	104	G4GC		09/06-03/10	SK16PR-L11	3395	1.1	-	IK16TT	IK16TT		4
2.0 All-wheel Drive	104	G4GC		08/04-12/06	K16PR-U11	3130	1.1	K16TT	IK16TT	IK16TT		4
2.0 All-wheel Drive	104	G4GC		09/06-03/10	SK16PR-L11	3395	1.1	-	IK16TT	IK16TT		4
2.0 CRDi	83/88/100/103/110	D4EA; D4EA-V		01/06-03/10	DG-173		11V					4
2.0 CRDi All-wheel Drive	83/88/100/103/110	D4EA; D4EA-F; D4EA-V		01/06-03/10	DG-173		11V					4
2.7 All-wheel Drive	129	G6BA(175)		08/04-09/06	PK16PR-L11	3275	1.1	-	IK16TT	IK16TT		6
2.7 All-wheel Drive	129	G6BA(175)		09/06-03/10	SK16PR-L11	3395	1.1	-	IK16TT	IK16TT		6
VELOSTER (11-)												
1.6 GDI	103	G4FD		03/11-	VXUH20I			-	-	VXUH20I		4
INFINITI												
EX (08-)												
35	221	VQ35HR		10/08-	VFXEH22	5646	1.1	-	IXEH22TT	IXEH22TT		6
37	228/235	VQ37VHR		10/08-	FXE24HR11	3457	1.1	-	-	FXE24HR11		6
FX (03-)												
35	206	VQ35DE		02/03-12/08	VKH16	5617	1.1	-	IKH16TT	IKH16TT		6
35 All-wheel Drive	206	VQ35DE		01/03-12/08	VKH16	5617	1.1	-	IKH16TT	IKH16TT		6
35 AWD	223	VQ35HR		01/12-	VFXEH22	5646	1.1	-	IXEH22TT	IXEH22TT		6
37 AWD	235	VQ37VHR		10/08-	FXE24HR11	3457	1.1	-	-	FXE24HR11		6
45	232	VK45DE		02/03-12/08	VKH16	5617	1.1	-	IKH16TT	IKH16TT		8
45 All-wheel Drive	232	VK45DE		01/03-12/08	VKH16	5617	1.1	-	IKH16TT	IKH16TT		8
50 AWD	287/309	VK50VE		10/08-	VFXEH22	5646	1.1	-	IXEH22TT	IXEH22TT		8
G (02-)												
35	191	VQ35DE		10/02-	VKH16	5617	1.1	-	IKH16TT	IKH16TT		6
37	235/243	VQ37VHR		10/08-	FXE24HR11	3457	1.1	-	-	FXE24HR11		6











Spark & Glow Plugs

Application Tables

	KW							Standard		Twin Tip			QTY
INFINITI <i>continued</i>													
G (02-) <i>continued</i>													
37 X	235	VQ37VHR		10/08-	FXE24HR11	3457	1.1	-	-	-	-	FXE24HR11	6
G20 (90-97)													
2.0	85	SR20DE		01/90-12/97	K20R-U	3122	0.8	K20TT	IK20TT	IK20TT			4
M (10-)													
35h	225	VQ35HR		04/11-	VFXEH22	5646	1.1	-	IXEH22TT	IXEH22TT			6
37	235	VQ37VHR		03/10-	FXE24HR11	3457	1.1	-	-	-		FXE24HR11	6
56	309	VK56VD		01/12-	VFXEH22	5646	1.1	-	IXEH22TT	IXEH22TT			8
M35 (05-)													
3.5 Luxury	206	VQ35DE		01/05-	VKH16	5617	1.1	-	IKH16TT	IKH16TT			6
3.5 Luxury All-wheel Drive	206	VQ35DE		01/05-	VKH16	5617	1.1	-	IKH16TT	IKH16TT			6
3.5 Luxury Hybrid	268			01/10-	VFXEH22	5646	1.1	-	IXEH22TT	IXEH22TT			6
M37 (10-)													
3.7	243	VQ37VHR		01/10-	FXE24HR11	3457	1.1	-	-	-		FXE24HR11	6
3.7 Allrad	243	VQ37VHR		01/10-	FXE24HR11	3457	1.1	-	-	-		FXE24HR11	6
M45 (05-)													
4.5 Luxury	250	VK45DE		01/05-	VKH16	5617	1.1	-	IKH16TT	IKH16TT			8
Q45 III (01-)													
4.5	250	VK45DE		02/01-	VKH16	5617	1.1	-	IKH16TT	IKH16TT			8
QX4 (97-)													
3.3	125	VG33E		01/97-	K16PR-U11	3130	1.1	K16TT	IK16TT	IK16TT			6
QX70 (13-)													
37 AWD	235	VQ37VHR		08/13-	FXE24HR11	3457	1.1	-	-	-		FXE24HR11	6
50 AWD	287	VK50VE		08/13-	VFXEH22	5646	1.1	-	IXEH22TT	IXEH22TT			8
INNOCENTI													
ELBA (91-96)													
1.3 (146CW)	49	146A5.000		08/91-12/92	W20EPR-U	3047	0.8	W20TT	IW20TT	IW20TT			4
1.4 i.e. (146EN, 146EQ)	49	146D5.000		09/94-12/96	K20PR-U	3145	0.8	K20TT	IK20TT	IK20TT			4
1.4 i.e. (146EN, 146EQ)	49	146C5.000		09/94-12/94	W20EPR-U	3047	0.8	W20TT	IW20TT	IW20TT			4
1.5 i.e. (146C9)	55	149C1.000		08/92-09/94	W22EPR-U	3088	0.8	W22TT	-	-		VW22	4
1.6 i.e. (146EO, 146ER)	55	146C6.000		09/94-12/94	W22EPR-U	3088	0.8	W22TT	-	-		VW22	4
1.7 D (146DI, 146EI)	42	146 B2.000		08/91-12/96	DG-001		11V						4
KORAL (90-92)													
45	33	100GL.000;100GL.06		01/90-12/92	W22EPR-U	3088	0.8	W22TT	-	-		VW22	4
55	40	128A.000		01/90-12/92	W22EPR-U	3088	0.8	W22TT	-	-		VW22	4
MINI (74-95)													
1.0	32/ 35/ 39	99H		05/74-02/82	W16EPR-U	3021	0.8	W16TT	IW16TT	IW16TT			4
1.3	47	12H		08/76-02/82	W20EX-U	3062	0.8	W20TT	IW20TT	IW20TT			4
1.3 De Tomaso	51	12H		08/76-02/82	W20EX-U	3062	0.8	W20TT	IW20TT	IW20TT			4
ISUZU													
ASKA (95-01)													
1.8 LF	103	F18B		10/95-09/01	PKJ16CR-L13	3357	1.3	-	IK16TT	IK16TT			4
2.3	71	4ZD1		10/97-09/01	W20EPR-U11	3049	1.1	W20TT	IW20TT	IW20TT			4
CAMPO (77-91)													
2.0 (KB23)	52	4ZC1		01/83-03/88	W20EPR-U	3047	0.8	W20TT	IW20TT	IW20TT			4
2.0 (KB28)	58	G200Z		06/85-12/88	W20EPR-U	3047	0.8	W20TT	IW20TT	IW20TT			4
2.0 4WD (KB43, KB48)	52	4ZC1		01/83-03/88	W20EPR-U	3047	0.8	W20TT	IW20TT	IW20TT			4
2.0 4WD (KB48)	58	G200Z		06/85-12/88	W20EPR-U	3047	0.8	W20TT	IW20TT	IW20TT			4
2.2 (TFS)	66	4ZD1		01/89-12/90	W20EPR-U11	3049	1.1	W20TT	IW20TT	IW20TT			4
2.2 D (KBD27)	39/45	C223		01/83-08/87	DG-124		11V						4
2.2 D (KBD27)	39/45	C223		09/87-12/91	DG-143		5V						4
2.2 D 4WD (KBD42, KBD47)	39	C223		01/83-08/87	DG-124		11V						4
2.2 D 4WD (KBD42, KBD47)	39	C223		09/87-12/90	DG-143		5V						4
2.5 D (KBD27)	55	4JA1		01/83-12/88	DG-001		11V						4
2.5 D 4WD (KBD47)	55	4JA1		01/83-12/88	DG-001		11V						4
D-MAX (02-)													
2.5 D	74	4JA1-TC		10/02-	DG-001		11V						4
2.5 D 4x4	74	4JA1-TC		05/02-	DG-001		11V						4
3.0 DiTD 4x4	96	4JH1-TC		05/02-	DG-001		11V						4
3.5 V6 24V 4x4	147	6VE1		05/02-12/02	IK16	5303	1.1	-	IK16TT	IK16TT			6
3.5 V6 24V 4x4	147	6VE1		01/03-	PK16PR-L11	3275	1.1	-	IK16TT	IK16TT			6
GEMINI (88-90)													
1.5 D	37	4EC1	Eng: >804794	02/88-11/88	DG-143		5V						4
1.5 D	37	4EC1	Eng: 804795>	12/88-12/90	DG-124		11V						4









Spark & Glow Plugs

Application Tables

	KW										QTY
ISUZU <i>continued</i>											
GEMINI (88-90) <i>continued</i>											
1.5 TD	49	4EC1T		12/88-12/90	DG-104		11V				4
1.5 TD	49	4EC1T		02/88-11/88	DG-159		5V				4
1.6 GTI 16V	84	4XE1		08/88-12/90	K20PR-U11	3121	1.1	K20TT	IK20TT	IK20TT	4
KB (10-)											
3.0 D-TEQ 4WD	120	4JJ1-TC		08/10-	DG-108		11V				4
MIDI (88-)											
2.0	61	4ZC1		06/88-	W20EPR-U	3047	0.8	W20TT	IW20TT	IW20TT	4
2.0 (98000)	61	4ZC1		01/89-	W20EPR-U	3047	0.8	W20TT	IW20TT	IW20TT	4
2.0 4WD	61	4ZC1		09/88-	W20EPR-U	3047	0.8	W20TT	IW20TT	IW20TT	4
2.0 4WD (94000)	61	4ZC1		01/89-	W20EPR-U	3047	0.8	W20TT	IW20TT	IW20TT	4
2.0 TD (98000)	51	4FC1T		01/89-	DG-104		11V				4
2.0 TD (98000)	51	4FC1T		01/89-	DG-159		5V				4
2.2 D	45	4FD1		01/89-	DG-104		11V				4
2.2 D (98000)	45	4FD1		01/89-	DG-104		11V				4
2.2 D 4WD	45	4FD1		09/88-	DG-104		11V				4
2.2 D 4WD (94000)	45	4FD1		01/89-	DG-104		11V				4
2.4 D (98000)	56	4FG1T		01/94-	DG-104		11V				4
2.4 D (98000)	56	4FG1T		01/94-	DG-159		5V				4
2.4 TD	56	4FG1T		02/94-	DG-104		11V				4
2.4 TD	56	4FG1T		02/94-	DG-159		5V				4
2.4 TD (98000)	56	4FG1T		01/94-	DG-104		11V				4
2.4 TD (98000)	56	4FG1T		01/94-	DG-159		5V				4
PIAZZA (85-90)											
2.0 Turbo	104	4ZC1-T		06/85-12/90	IW20	5306	1.1	-	IW20TT	IW20TT	4
PICK UP (87-96)											
2.3	70	4ZD1		10/87-08/96	W20EPR-U	3047	0.8	W20TT	IW20TT	IW20TT	4
2.3 4x4	70	4ZD1		10/87-08/96	W20EPR-U11	3049	1.1	W20TT	IW20TT	IW20TT	4
2.6 LS	84/90	4ZE1		10/87-08/96	W20EPR-U	3047	0.8	W20TT	IW20TT	IW20TT	4
TROOPER (83-91)											
2.2 (UBS13)	58	G200Z		01/83-12/85	W20EPR-U	3047	0.8	W20TT	IW20TT	IW20TT	4
2.2 D (UBS52)	45	C223T		01/83-12/83	DG-124		11V				4
2.2 D 4x4	39	C223		08/87-12/89	DG-124		11V				4
2.2 D 4x4	39	C223		05/84-07/87	DG-143		5V				4
2.2 TD (UBS52)	53	C223T		08/87-12/91	DG-124		11V				4
2.2 TD (UBS52)	53	C223T		03/84-07/87	DG-143		5V				4
2.3 (UBS16)	66	4ZD1		11/85-12/91	W20EPR-U	3047	0.8	W20TT	IW20TT	IW20TT	4
2.6 4x4	85	4ZE1		11/86-07/91	W20EPR-U11	3049	1.1	W20TT	IW20TT	IW20TT	4
2.6 i (UBS17)	85	4ZE1		10/87-12/91	W20EX-U	3062	0.8	W20TT	IW20TT	IW20TT	4
2.8 TD (UBS55)	71/78	4JB1T; 4JB1-TC		10/87-12/91	DG-108		11V				4
TROOPER (91-98)											
3.1 TD	84	4JG2 T		08/91-12/97	DG-104		11V				4
3.2	130	6VDI		01/98-07/98	IK16	5303	1.1	-	IK16TT	IK16TT	6
3.2	130	6VDI		07/95-07/98	K20PR-U11	3121	1.1	K20TT	IK20TT	IK20TT	6
TROOPER (00-)											
3.0 DTI	118	4JX1; 4JX1T		04/00-	DG-186		11V				4
3.5 V6 24V	158	6VE1		04/00-12/02	IK16	5303	1.1	-	IK16TT	IK16TT	6
3.5 V6 24V	158	6VE1		01/03-	PK16PR-L11	3275	1.1	-	IK16TT	IK16TT	6
IVECO											
DAILY I (78-89)											
45-10 (10331211, 10331212, 10331217, 10331304, 10331311...)	68	8140.21.200		01/85-12/89	DG-111		11V				4
45-10 V (10334204, 10334211, 10334212, 10334217, 10334404)	68	8140.21.200		01/85-12/89	DG-111		11V				4
DAILY II (89-99)											
30-8 (10011131, 10011132, 10011231, 10011232, 10011237...)	60	8140.67F.; 8140.67F.3710; 8140.67F.3711; 8140.67F.3713; 8140.67F.3721		04/96-08/98	DG-111		11V				4
30-8 (14911111, 14911117, 14911211, 14911215, 14911217...)	62	8140.63.		09/98-05/99	DG-111		11V				4
30-8 (14914111, 14914117, 14914211, 14914217, 14915111...)	60	8140.67F.; 8140.67F.3710; 8140.67F.3711; 8140.67F.3713; 8140.67F.3721		04/96-08/98	DG-111		11V				4







Spark & Glow Plugs









Application Tables

	KW					Standard				QTY
IVECO <i>continued</i>										
DAILY II (89-99) <i>continued</i>										
35-10 (12971112, 12971212, 12971312, 12971317, 12976112...)	68	8140.97.2781		01/89-03/96	DG-001		11V			4
35-8 (12934104, 12934111, 12934112, 12934117, 12934124...)	60	8140.67F.; 8140.67F.3701; 8140.67F.3710; 8140.67F.3711; 8140.67F.3713; 8140.67F.3721		04/96-08/98	DG-111		11V			4
DAILY III (97-06)										
29 L 10 (ALJAV1A1, ALJA41AA, ALJA41A1, AHJA64A1...)	70	F1AE0481A		09/02-	DG-195		11V			4
29 L 10 V (ALJA43A2, ALJA42A2, ALJA41A2)	70	F1AE0481A		09/02-	DG-195		11V			4
29 L 12 (ALKA41A1, AHKA64A1, ALLA51A1)	85	F1AE0481B		09/02-	DG-195		11V			4
29 L 12 V (ALKA41A2, ALLA52A2, ALKA42A2)	85	F1AE0481B		09/02-	DG-195		11V			4
29 L 14	100	F1AE0481M		01/05-04/06	DG-195		11V			4
29 L 14 (AHRA11C1B1, AHRA14C1B1, AHRA64C1B1)	100	F1AE0481M		11/05-	DG-195		11V			4
29 L 9	62	8140.63.		05/99-04/06	DG-111		11V			4
29 L 9 V	62	8140.63.		05/99-04/06	DG-111		11V			4
35 C 10 V, 35 S 10 V (AMJA11A1, AMJA14A1, AMJA64A1...)	70	F1AE0481A		09/02-	DG-195		11V			4
35 C 12, 35 S 12 (AEKA14A1, AEKA14AA, AEKA64A1...)	85	F1AE0481B		09/02-	DG-195		11V			4
35 C 12 V, 35 S 12 V (AGKA43A2, AGKB43A2, AGKB46A2...)	85	F1AE0481B		09/02-	DG-195		11V			4
35 C 14	100	F1CE0481A		09/04-04/06	DG-195		11V			4
35 C 14, 35 S 14	100	F1AE0481M		01/05-04/06	DG-195		11V			4
35 C 15	107	8140.43N		11/01-	DG-111		11V			4
35 C 17, 35 S 17	122	F1CE0481B		01/05-04/06	DG-195		11V			4
35 S 10 (ANJA41A1, ANJA42A2, ANJA42AB, ANJA43A, ANJAV1A...)	70	F1AE0481A		09/02-	DG-195		11V			4
35 S 15 V, 35 C 15 V (A6HCV3B2, A6HBV4B2, A6HC41B2...)	107	8140.43N		11/02-	DG-111		11V			4
35 S 9 V, 35 C 9 V	62	8140.63.		05/99-04/06	DG-111		11V			4
35 S 9, 35 C 9	62	8140.63.		05/99-04/06	DG-111		11V			4
40 C 14	100	F1AE0481M; F1CE0481A		09/04-04/06	DG-195		11V			4
40 C 15	107	8140.43N		11/01-04/06	DG-111		11V			4
40 C 17, 40 S 17	122	F1CE0481B		01/05-04/06	DG-195		11V			4
50 C 14	100	F1CE0481A		09/04-04/06	DG-195		11V			4
50 C 15	107	8140.43N		01/01-	DG-111		11V			4
50 C 17	122	F1CE0481B		09/04-04/06	DG-195		11V			4
65 C 14	100	F1CE0481A		09/04-04/06	DG-195		11V			4
65 C 15	107	8140.43N		11/01-	DG-111		11V			4
65 C 17	122	F1CE0481B		09/04-04/06	DG-195		11V			4
DAILY IV (06-)										
29L10	70	F1AE0481FA		05/06-	DG-195		11V			4
29L10 V	70	F1AE0481FA		05/06-	DG-195		11V			4
29L12	85	F1AE0481GA		05/06-	DG-195		11V			4
29L12 V, 29L12 V/P	85	F1AE0481GA		05/06-	DG-195		11V			4
29L14	100	F1AE0481HA		05/06-	DG-195		11V			4
29L14 C, 29L14 C/P, 29L14 V, 29L14 V/P	100	F1AE0481HA		05/06-	DG-195		11V			4
35C10 K	70	F1AE0481FA		05/06-	DG-195		11V			4
35C10, 35S10	70	F1AE0481FA		05/06-	DG-195		11V			4
35C11 K, 35C11 DK, 35S11 K, 35S11 DK	78	F1AE0481FA		07/07-	DG-195		11V			4
35C11 V, 35S11 V	78	F1AE0481FA		07/07-	DG-195		11V			4
35C11, 35S11, 35S11 D, 35S11 /P	78	F1AE0481FA		07/07-	DG-195		11V			4
35C12	85	F1AE0481GA		05/06-	DG-195		11V			4
35C12 V, 35C12 V/P, 35S12 V, 35S12 V/P	85	F1AE0481GA		05/06-	DG-195		11V			4
35C12, 35S12	85	F1AE0481GA		05/06-	DG-195		11V			4
35C13 K, 35C13 DK, 35S13 K, 35S13 DK	93	F1AE0481GA		07/07-	DG-195		11V			4

Spark & Glow Plugs







Application Tables

	KW					Standard		Twin Tip		QTY
IVECO <i>continued</i>										
DAILY IV (06-) <i>continued</i>										
35C13 V, 35C13 V/P, 35S13 V, 35S13 V/P	93	F1AE0481GA		07/07-	DG-195	11V				4
35C13, 35C13 /P, 35S13 D, 35S13, 35S13 /P	93	F1AE0481GA		07/07-	DG-195	11V				4
35C14 K, 35C14 DK, 35S14 K, 35S14 DK	103	F1CE3481LC		07/07-	DG-195	11V				4
35C14 V, 35C14 V/P, 35S14 V, 35S14 V/P	103	F1CE3481LC		07/07-	DG-195	11V				4
35C14, 35C14 /P, 35S14, 35S14 /P, 35S14 D, 35S14 D/P	103	F1CE3481LC		07/07-	DG-195	11V				4
35C14, 35S14, 35S14 /P	100	F1AE0481HA		05/06-	DG-195	11V				4
35C15	107	F1CE0481FA		05/06-	DG-195	11V				4
35C15 V, 35C15 V/P	107	F1CE0481FA		05/06-	DG-195	11V				4
35C17 K, 35C17 DK, 35S17 K, 35S17 DK	125	F1CE0481HA		07/07-	DG-195	11V				4
35C17 V, 35C17 V/P, 35S17 V, 35S17 V/P	125	F1CE0481HA		07/07-	DG-195	11V				4
35C17, 35C17 /P, 35S17, 35S17 /P, 35S17 D	125	F1CE0481HA		07/07-	DG-195	11V				4
35C18	130	F1CE0481HA		05/06-	DG-195	11V				4
35C18 V, 35C18 V/P, 35S18 V, 35S18 V/P	130	F1CE0481HA		05/06-	DG-195	11V				4
35C18, 35S18	130	F1CE0481HA		05/06-	DG-195	11V				4
35S14 C, 35S14 C/P, 35S14 V, 35S14 V/P, 35C14 V, 35C14 V/P	100	F1AE0481HA		05/06-	DG-195	11V				4
35S14 K, 35S14 DK	100	F1AE0481HA		07/07-	DG-195	11V				4
35S14, 35S14 /P	100	F1AE0481HA		05/06-	DG-195	11V				4
35S15	110	F1CE0481L		06/06-	DG-195	11V				4
35S17 W, 35S17 WD	125	F1CE0481HA		07/07-	DG-195	11V				4
40C10	70	F1AE0481FA		05/06-	DG-195	11V				4
40C10 V	70	F1AE0481FA		05/06-	DG-195	11V				4
40C11 V	78	F1AE0481FA		07/07-	DG-195	11V				4
40C11, 40C11 D	78	F1AE0481FA		07/07-	DG-195	11V				4
40C12	85	F1AE0481GA		05/06-	DG-195	11V				4
40C12 V, 40C14 V/P	85	F1AE0481GA		05/06-	DG-195	11V				4
40C13 V, 40C13 V/P	93	F1AE0481GA		07/07-	DG-195	11V				4
40C13, 40C13 /P	93	F1AE0481GA		07/07-	DG-195	11V				4
40C14 K, 40C14 DK	103	F1CE3481LC		07/07-	DG-195	11V				4
40C14 V, 40C14 V/P	103	F1CE3481LC		07/07-	DG-195	11V				4
40C14, 40C14 /P	103	F1CE3481LC		07/07-	DG-195	11V				4
40C15	107	F1CE0481FA		05/06-	DG-195	11V				4
40C15 V, 40C15 V/P	107	F1CE0481FA		05/06-	DG-195	11V				4
40C17 K, 40C17 DK	125	F1CE0481HA		07/07-	DG-195	11V				4
40C17 V, 40C17 V/P	125	F1CE0481HA		07/07-	DG-195	11V				4
40C17, 40C17 /P	125	F1CE0481HA		07/07-	DG-195	11V				4
40C18	130	F1CE0481HA		05/06-	DG-195	11V				4
40C18 V, 40C18 V/P	130	F1CE0481HA		05/06-	DG-195	11V				4
45C14, 45C14 /P	103	F1CE3481LC		07/07-	DG-195	11V				4
45C15	107	F1CE0481FA		05/06-	DG-195	11V				4
45C15 V	107	F1CE0481FA		05/06-	DG-195	11V				4
45C17 V, 45C17 V/P	125	F1CE0481HA		07/07-	DG-195	11V				4
45C17, 45C17 /P	125	F1CE0481HA		07/07-	DG-195	11V				4
45C18	130	F1CE0481HA		05/06-	DG-195	11V				4
45C18, 45C18 /P, 45C18 D, 45C18 D/P	130	F1CE0481HA		05/06-	DG-195	11V				4
50C14 K, 50C14 DK	103	F1CE3481LC		07/07-	DG-195	11V				4
50C14 V, 50C14 V/P	103	F1CE3481LC		07/07-	DG-195	11V				4
50C14, 50C14 /P	103	F1CE3481LC		07/07-	DG-195	11V				4
50C15	107	F1CE0481FA		05/06-	DG-195	11V				4
50C15 V, 50C15 V/P	107	F1CE0481FA		05/06-	DG-195	11V				4
50C17 K, 50C17 DK	125	F1CE0481HA		07/07-	DG-195	11V				4
50C17 V, 50C17 V/P	125	F1CE0481HA		07/07-	DG-195	11V				4
50C17, 50C17 /P	125	F1CE0481HA		07/07-	DG-195	11V				4
50C18	130	F1CE0481HA		05/06-	DG-195	11V				4
50C18 V, 50C18 V/P	130	F1CE0481HA		05/06-	DG-195	11V				4
55S17 W, 55S17 WD	125	F1CE0481HA		07/07-	DG-195	11V				4
60C14 K, 60C14 DK	103	F1CE3481LC		07/07-	DG-195	11V				4
60C14, 60C14 /P	103	F1CE3481LC		07/07-	DG-195	11V				4
60C15	107	F1CE0481FA		05/06-	DG-195	11V				4
60C15 V	107	F1CE0481FA		05/06-	DG-195	11V				4

	KW					Standard				QTY	
IVECO <i>continued</i>											
DAILY IV (06-) <i>continued</i>											
60C15, 60C15 /P, 60C15 D, 60C15 D/P	107	F1CE0481FA		05/06-	DG-195		11V			4	
60C17 K, 60C17 DK	125	F1CE0481HA		07/07-	DG-195		11V			4	
60C17 V, 60C17 V/P	125	F1CE0481HA		07/07-	DG-195		11V			4	
60C17, 60C17 /P	125	F1CE0481HA		07/07-	DG-195		11V			4	
60C18	130	F1CE0481HC		05/06-	DG-195		11V			4	
65C14 K, 65C14 DK	103	F1CE3481LC		07/07-	DG-195		11V			4	
65C14 V, 65C14 V/P	103	F1CE3481LC		07/07-	DG-195		11V			4	
65C14, 65C14 /P	103	F1CE3481LC		07/07-	DG-195		11V			4	
65C15	107	F1CE0481FA		05/06-	DG-195		11V			4	
65C15, 65C15 /P, 65C15 D, 65C15 D/P	107	F1CE0481FA		05/06-	DG-195		11V			4	
65C17 K, 65C17 DK, 65C17KK	125	F1CE0481HA		07/07-	DG-195		11V			4	
65C17 V, 65C17 V/P	125	F1CE0481HA		07/07-	DG-195		11V			4	
65C17, 65C17 /P	125	F1CE0481HA		07/07-	DG-195		11V			4	
65C18	130	F1CE0481HC		05/06-	DG-195		11V			4	
70C14 K, 70C14 DK, 70C14 KK	103	F1CE3481LC		07/07-	DG-195		11V			4	
70C14 V, 70C14 V/P	103	F1CE3481LC		07/07-	DG-195		11V			4	
70C14, 70C14 /P	103	F1CE3481LC		07/07-	DG-195		11V			4	
70C17 K, 70C17 DK, 70C17 KK	125	F1CE0481HA		07/07-	DG-195		11V			4	
70C17, 70C17 /P	125	F1CE0481HA		07/07-	DG-195		11V			4	
70C17V, 70C17 V/P	125	F1CE0481HA		07/07-	DG-195		11V			4	
DAILY V (11-)											
26L11, 26L11D, 35C11D, 35S11, 40C11	78	F1AE3481A		09/11-	DG-195		11V			4	
29L11 V, 35C11 V, 35S11 V, 40C11 V	78	F1AE3481A		09/11-	DG-195		11V			4	
29L13 V, 35C13 V, 35S13 V, 40C13 V, 40S13 V	93	F1AE3481B		09/11-	DG-195		11V			4	
29L13, 29L13D, 35C13D, 40C13	93	F1AE3481B		09/11-	DG-195		11V			4	
29L15 V, 35C15L V, 40C15L V, 50C15L V	107	F1AE3481C		09/11-	DG-195		11V			4	
35C11K, 35S11DKP	78	F1AE3481A		09/11-	DG-195		11V			4	
35C13K, 35C13DKP	93	F1AE3481B		09/11-	DG-195		11V			4	
35C15 V, 40C15 V	107	F1CE3481J; F1CE3481L		09/11-	DG-195		11V			4	
35C15, 35C15D, 35S15, 40C15, 45C15, 50C15, 60C15, 70C15	107	F1CE3481J; F1CE3481L		09/11-	DG-195		11V			4	
35C15K, 35S15DKP, 50C15K, 60C15K, 65C15DK, 70C15K	107	F1CE3481L		09/11-	DG-195		11V			4	
35C17 V, 35S17 V, 40C17 V, 45C17 V, 50C17 V, 60C17 V,	125	F1CE3481C; F1CE3481K		09/11-	DG-195		11V			4	
35C17, 35C17D, 35S17, 40C17, 45C17, 50C17, 60C17, 70C17	125	F1CE3481C; F1CE3481K		09/11-	DG-195		11V			4	
35C17K, 35S17DKP, 50C17K, 65C17DK 70C17K	125	F1CE3481C; F1CE3481K		09/11-	DG-195		11V			4	
35C21 V, 35S21 V, 40C21 V, 45C21 V, 50C21 V	150	F1CE3481D		09/11-	DG-195		11V			4	
35C21, 35S21, 40C21, 45C21, 50C21, 60C21, 70C21	150	F1CE3481D		09/11-	DG-195		11V			4	
35S21DKP	150	F1CE3481D		09/11-	DG-195		11V			4	
MASSIF (08-)											
3.0 HPI	107	F1CE0481FA		10/08-	DG-195		11V			4	
3.0 HPT	130	F1CE0481HA		10/08-	DG-195		11V			4	
JAGUAR											
E-TYPE 2+2 (66-75)											
4.2 (Series 1)	195			06/66-09/68	W16EPR-U	3021	0.8	W16TT	IW16TT	IW16TT	6
4.2 (Series2)	127			05/68-05/71	W16EPR-U	3021	0.8	W16TT	IW16TT	IW16TT	6
4.2 (Series3)	127			03/71-04/75	W16EPR-U	3021	0.8	W16TT	IW16TT	IW16TT	6
V12 5.3 (Series3)	203			03/71-04/75	W16EPR-U	3021	0.8	W16TT	IW16TT	IW16TT	12
E-TYPE (61-75)											
4.2 (Series 1)	195			05/64-09/68	W16EPR-U	3021	0.8	W16TT	IW16TT	IW16TT	6
4.2 (Series2)	198			07/68-05/71	W16EPR-U	3021	0.8	W16TT	IW16TT	IW16TT	6
4.2 (Series3)	127			03/71-04/75	W16EPR-U	3021	0.8	W16TT	IW16TT	IW16TT	6
V12 5.3 (Series3)	203			03/71-04/75	W16EPR-U	3021	0.8	W16TT	IW16TT	IW16TT	12







Spark & Glow Plugs

Application Tables

	KW				Standard 			Twin Tip 			QTY
JAGUAR continued											
Mk X (61-70)											
4.2	198			09/61-07/68	W16EPR-U	3021	0.8	W16TT	IW16TT	IW16TT	6
420	183			09/67-10/69	W16EPR-U	3021	0.8	W16TT	IW16TT	IW16TT	6
420G	190			09/66-10/70	W16EPR-U	3021	0.8	W16TT	IW16TT	IW16TT	6
S-TYPE (99-08)											
2.5 V6	147			04/02-10/07	ZT20EPR11	5087	1.1	T20TT	IT20TT	IT20TT	6
2.7 D	152	AJD		06/04-10/07	DG-140		11V				6
3.0 V6	175	AJ-V6; FB		01/99-10/07	ZT20EPR11	5087	1.1	T20TT	IT20TT	IT20TT	6
4.0 V8	203	AJ-V8		01/99-04/02	PK16PR-L11	3275	1.1	-	IK16TT	IK16TT	8
4.2 V8	219			04/02-10/07	ZT20EPR11	5087	1.1	T20TT	IT20TT	IT20TT	8
R 4.2 V8	291	AJ8FT		04/02-10/07	ZT20EPR11	5087	1.1	T20TT	IT20TT	IT20TT	8
XF (08-)											
2.0	177	204PT	40000km Lifetime	06/12-	ITV22	5340	0.8	-	-	-	4
2.7 D	152	AJD		03/08-03/09	DG-140		11V				6
3.0	175	AJ6WG		03/08-	ZT20EPR11	5087	1.1	T20TT	IT20TT	IT20TT	6
4.2	219	SV82G		03/08-03/09	SK16PR-A11	3356	1.1	-	IK16TT	IK16TT	8
4.2 Kompressor	306	SV8TS		03/08-03/09	SK16PR-A11	3356	1.1	-	IK16TT	IK16TT	8
5.0	283	AJ-V8-5.0		03/09-	SK16PR-A11	3356	1.1	-	IK16TT	IK16TT	8
5.0 Kompressor	375	AJ-V8-5.0C		03/09-	SK16PR-A11	3356	1.1	-	IK16TT	IK16TT	8
XJ (68-93)											
6 4.2	124/ 127/ 130/ 133/ 137/ 151	8L (85-87); XK 4.2 (-79); XK 4.2 (82-87)		01/75-12/87	W16EPR-U	3021	0.8	W16TT	IW16TT	IW16TT	6
12 5.3	187	7P		08/86-09/89	T22EP-U	5040	0.8	-	-	-	12
12 5.3	186/ 198/ 211	V 12 (75-79)		09/73-12/82	W16EPR-U	3021	0.8	W16TT	IW16TT	IW16TT	12
12 H.E.	217	V 12 (82-90)		09/81-12/92	T22EP-U	5040	0.8	-	-	-	12
Sovereign V12	194/ 197	7P; V 12 (90-93, 197KW)		07/85-12/92	T22EP-U	5040	0.8	-	-	-	12
XJ (86-94)											
6 3.2 24V	146	9BPMNA		09/90-11/94	Q20PR-U	3007	0.8	Q20TT	IQ20TT	IQ20TT	6
6 4.0	163	9EPCNA		09/89-11/94	K20PR-U	3145	0.8	K20TT	IK20TT	IK20TT	6
XJ (94-97)											
6 3.2	155	9JPGRB		11/94-07/97	Q20PR-U	3007	0.8	Q20TT	IQ20TT	IQ20TT	6
6 Sovereign 4.0	177	9JPFRR		11/94-07/97	K20PR-U	3145	0.8	K20TT	IK20TT	IK20TT	6
12 6.0	229	8E		11/94-07/97	T20EPR-U	5032	0.8	T20TT	IT20TT	IT20TT	12
R Super Charged 4.0	235	9KPDRB		11/94-07/97	K22PR-U	3165	0.8	-	-	VK22	6
XJ (97-03)											
8 3.2	174			07/97-03/98	IK20	5304	1.1	-	IK20TT	IK20TT	8
8 3.2	174			07/97-05/03	PK16PR-L11	3275	1.1	-	IK16TT	IK16TT	8
8 4.0	209	BC		07/97-05/03	SK16PR-A11	3356	1.1	-	IK16TT	IK16TT	8
R 4.0	267	AJ-V8-4.0R(363)	Ch: 878717>	07/97-05/03	PK20PR-L13	3172	1.3	-	IK20TT	IK20TT	8
XJ (03-09)											
2,7 D	152	AJD		10/05-03/09	DG-140		11V				6
3.0	175	AJ-V6		05/03-03/09	ZT20EPR11	5087	1.1	T20TT	IT20TT	IT20TT	6
3.5	190			05/03-03/09	SK16PR-A11	3356	1.1	-	IK16TT	IK16TT	8
4.2	219	AJ-V8		05/03-03/09	SK16PR-A11	3356	1.1	-	IK16TT	IK16TT	8
R 4.2	291	AJ8FT		05/03-03/09	SK16PR-A11	3356	1.1	-	IK16TT	IK16TT	8
XJ (09-)											
2.0	177	204PT	40000km Lifetime	05/12-	ITV22	5340	0.8	-	-	-	4
3.0	175	AJ-V6		01/11-	ZT20EPR11	5087	1.1	T20TT	IT20TT	IT20TT	6
5.0 V 8	283	AJ-V8-5.0	Ch: B16769>	10/09-	SK16PR-A11	3356	1.1	-	IK16TT	IK16TT	8
5.0 V8	375	AJ-V8-5.0C		10/09-	SK16PR-A11	3356	1.1	-	IK16TT	IK16TT	8
5.0 V8	346	508PS	Ch: B16769>	10/09-	SK16PR-A11	3356	1.1	-	IK16TT	IK16TT	8
XJ Coupe (73-96)											
3.6	162	AJ 6 (3.6, 162KW)		10/83-12/88	K20PR-U	3145	0.8	K20TT	IK20TT	IK20TT	6
4.0	163	9EPCNA		05/91-09/94	Q20PR-U	3007	0.8	Q20TT	IQ20TT	IQ20TT	6
5.3	197/ 202/ 207/ 211/ 213	8C (88-92); 8S (92-93); V 12 (90-93, 197KW); V 12 (90-93, 211KW)		09/75-12/89	T22EP-U	5040	0.8	-	-	-	12
5.3 H.E.	194/ 217	8S (86-88); V 12 (82-90)		07/81-12/89	T22EP-U	5040	0.8	-	-	-	12
6.0	222	8D		11/94-03/96	T20EPR-U	5032	0.8	T20TT	IT20TT	IT20TT	12











Spark & Glow Plugs





Application Tables

	KW					Standard		Twin Tip			QTY
JAGUAR <i>continued</i>											
XJ Coupe (73-96) <i>continued</i>											
6.0	222/ 238/ 248	8D		11/91-11/94	T22EP-U	5040	0.8	-	-	-	12
XJSC (85-96)											
5.3	197/ 202/ 207/ 211	8C (88-92); 8S (92-93); V 12 (90-93, 197KW); V 12 (90-93, 211KW)		01/86-05/92	T22EP-U	5040	0.8	-	-	-	12
5.3 H.E.	194/ 217	8S (86-88); V 12 (82-90)		07/85-05/92	T22EP-U	5040	0.8	-	-	-	12
6.0	222	8D		11/94-03/96	T20EPR-U	5032	0.8	T20TT	IT20TT	IT20TT	12
6.0	222	8D		05/93-11/94	T22EP-U	5040	0.8	-	-	-	12
XK 8 (96-05)											
4.0	209/ 216	AJ27; CC; CE		03/96-07/05	PK16PR-L11	3275	1.1	-	IK16TT	IK16TT	8
4.0	267	EC		02/98-07/05	PK20PR-L13	3172	1.3	-	IK20TT	IK20TT	8
4.0 XKR	276			05/98-07/05	PK20PR-L13	3172	1.3	-	IK20TT	IK20TT	8
4.2	219			08/02-07/05	PK20PR-L13	3172	1.3	-	IK20TT	IK20TT	8
4.2	219			08/02-07/05	SK16PR-A11	3356	1.1	-	IK16TT	IK16TT	8
R 4,2	291	AJ8FT		08/02-07/05	SK16PR-A11	3356	1.1	-	IK16TT	IK16TT	8
R 4,2	291	AJ8FT		08/02-07/05	ZT20EPR11	5087	1.1	T20TT	IT20TT	IT20TT	8
XK (06-14)											
4.2 XK8	219			03/06-07/14	SK16PR-A11	3356	1.1	-	IK16TT	IK16TT	8
4.2 XKR	306			03/06-07/14	SK16PR-A11	3356	1.1	-	IK16TT	IK16TT	8
5.0 V8	283	AJ-V8-5.0	Ch: B16769>	01/09-07/14	SK16PR-A11	3356	1.1	-	IK16TT	IK16TT	8
X-TYPE (01-09)											
2.0 D	96	FMBA; FMBB; R4-X404		07/03-12/09	DG-130		11.5V				4
2.0 V6	115			03/02-03/09	ZT20EPR11	5087	1.1	T20TT	IT20TT	IT20TT	6
2.2 D	107/ 110/ 114	LJ46G		10/05-12/09	DG-130		11.5V				4
2.5	144			02/04-12/09	ZT20EPR11	5087	1.1	T20TT	IT20TT	IT20TT	6
2.5 V6 All-wheel Drive	144			06/01-11/09	ZT20EPR11	5087	1.1	T20TT	IT20TT	IT20TT	6
3.0	169	AJ-V6		02/04-12/09	ZT20EPR11	5087	1.1	T20TT	IT20TT	IT20TT	6
3.0 V6 All-wheel Drive	169	AJ-V6		06/01-11/07	ZT20EPR11	5087	1.1	T20TT	IT20TT	IT20TT	6
JEEP											
CHEROKEE / LIBERTY (08-)											
3.7 V6	157	EKG		01/08-	KJ20CR-L11	3169	1.1	K20TT	IK20TT	IK20TT	6
3.7 V6 4x4	151/ 157	EKG-204		01/08-	KJ20CR-L11	3169	1.1	K20TT	IK20TT	IK20TT	6
CHEROKEE (80-86)											
2.5	81			10/83-09/86	QJ16HR-U9	5018	0.9	-	-	-	4
5.9 4x4	128			10/80-09/86	W16EPR-U	3021	0.8	W16TT	IW16TT	IW16TT	8
CHEROKEE (84-01)											
2.1 TD	59/64	J8S		10/84-03/92	DG-001		11V				4
2.1 TD	59/64	J8S		06/89-09/01	DG-006		11V				4
2.5	89/90	EPE		10/86-09/96	KJ16CR-L11	3132	1.1	K16TT	IK16TT	IK16TT	4
2.5 4x4	87/90	EPE		10/84-09/90	KJ16CR-L11	3132	1.1	K16TT	IK16TT	IK16TT	4
2.5 i 4x4	87/90	EPE; HX		10/84-09/01	KJ16CR-L11	3132	1.1	K16TT	IK16TT	IK16TT	4
2.5 SE	87	EPE		10/96-09/99	KJ16CR-L11	3132	1.1	K16TT	IK16TT	IK16TT	4
2.5 TD	85	ENC		01/88-12/95	DG-001		11V				4
2.5 Tdi 4x4	85	ENC		10/96-12/96	DG-001		11V				4
2.5 Tdi 4x4	85	ENC		01/97-09/01	DG-109		11V				4
4.0	131	M400L		10/86-09/90	K20PR-U	3145	0.8	K20TT	IK20TT	IK20TT	6
4.0 4x4	131	M400L		10/86-09/90	K20PR-U	3145	0.8	K20TT	IK20TT	IK20TT	6
4.0 i	127/ 135/ 136	ERH; MX		01/88-09/01	KJ16CR-L11	3132	1.1	K16TT	IK16TT	IK16TT	6
4.0 i 4x4	131	ERH		01/95-09/01	KJ16CR-L11	3132	1.1	K16TT	IK16TT	IK16TT	6
CHEROKEE (01-08)											
2.4 4x4	108	ED1		09/01-09/03	ITL16	5349	1.1	-	ITL16TT	ITL16TT	4
2.5 CRD 4x4	105	R 425 DOHC		09/01-01/08	DG-176		11.5V				4
2.8 CRD 4x4	110/ 120	ENR		11/02-01/08	DG-176		11.5V				4
3.7 4x4	150/ 155	EKG		09/01-01/08	KJ20CR-L11	3169	1.1	K20TT	IK20TT	IK20TT	6
3.7 Laredo	150	EKG		10/01-09/04	KJ20CR-L11	3169	1.1	K20TT	IK20TT	IK20TT	6
CJ5 - CJ8 (66-87)											
2.5	78			01/84-12/87	KJ16CR-L11	3132	1.1	K16TT	IK16TT	IK16TT	4
4.2	76			01/72-12/87	QJ16CR11	3295	1.1	Q16TT	IQ16TT	IQ16TT	6

Spark & Glow Plugs











Application Tables







	KW										QTY
JEEP continued											
COMANCHE (86-96)											
2.5	90	EPE		10/86-09/90	KJ16CR-L11	3132	1.1	K16TT	IK16TT	IK16TT	4
2.5 4x4	90	EPE		10/86-09/90	KJ16CR-L11	3132	1.1	K16TT	IK16TT	IK16TT	4
COMMANDER (05-10)											
3.0 CRD 4x4	160	EXL		04/06-04/10	DG-194		4.4V				6
3.7 V6 4x4	157	EKG		09/05-12/10	KJ20CR-L11	3169	1.1	K20TT	IK20TT	IK20TT	6
4.7 V8 4x4	170	EVA-231		09/05-12/10	KJ16CR-L11	3132	1.1	K16TT	IK16TT	IK16TT	8
5.7 V8 4x4	240	EZB		09/05-12/10	ITL16	5349	1.1	-	ITL16TT	ITL16TT	8
COMPASS (06-)											
2.0	115	ECN		05/11-	KJ16CR-U11	3311	1.1	K16TT	IK16TT	IK16TT	4
2.0 CRD	103	ECD; ECE		08/06-	DG-190		4.4V				4
2.0 CRD 4x4	103	ECE		09/06-	DG-190		4.4V				4
2.4	125	ERZ		08/06-	KJ16CR-U11	3311	1.1	K16TT	IK16TT	IK16TT	4
2.4 4x4	125	ERZ		09/06-	KJ16CR-U11	3311	1.1	K16TT	IK16TT	IK16TT	4
GRAND CHEROKEE I (91-99)											
2.5 TD 4x4 (Z)	85	M51; M52		10/95-04/99	DG-109		11V				4
4.0 i 4x4 (Z)	130	S01		10/95-04/99	KJ20CR-L11	3169	1.1	K20TT	IK20TT	IK20TT	6
4.0 i 4x4 (ZJ)	132/ 135	ERH; MX		09/91-04/99	KJ20CR-L11	3169	1.1	K20TT	IK20TT	IK20TT	6
4.0 Laredo	131	ERH		10/96-09/98	KJ20CR-L11	3169	1.1	K20TT	IK20TT	IK20TT	6
5.2	164	ELF		10/96-09/98	QJ16HR-U9	5018	0.9	-	-	-	8
5.2 4x4	164	ELF		10/96-09/98	QJ16HR-U9	5018	0.9	-	-	-	8
5.2 4x4 (Z)	156	Y01		10/95-04/99	QJ16HR-U9	5018	0.9	-	-	-	8
5.2 i 4x4 (ZJ)	155/ 158	ELF; Y		01/92-04/99	QJ16HR-U9	5018	0.9	-	-	-	8
5.2 Limited 4x4	136	ELF		10/96-09/98	QJ16HR-U9	5018	0.9	-	-	-	8
5.9 i 4x4	177	JEEO02		08/97-04/99	QJ16HR-U9	5018	0.9	-	-	-	8
GRAND CHEROKEE II (98-05)											
2.7 CRD 4x4	120	ENF		10/01-09/05	DG-109		11V				5
3.1 TD 4x4	103	EXA	OE: 5175756AA	04/99-12/01	DG-194		4.4V				5
3.1 TD 4x4	103	EXA	OE: 88900716	04/99-12/01	DG-109		11V				5
3.7 Laredo	157	EKG		10/04-09/05	KJ20CR-L11	3169	1.1	K20TT	IK20TT	IK20TT	6
4.0	140	ERH		10/98-09/04	KJ16CR-L11	3132	1.1	K16TT	IK16TT	IK16TT	6
4.0 4x4	140	ERH		04/99-09/05	KJ16CR-L11	3132	1.1	K16TT	IK16TT	IK16TT	6
4.7 V8 4x4	162/ 167/ 190	EVA; EVC		04/99-09/05	KJ16CR-L11	3132	1.1	K16TT	IK16TT	IK16TT	8
4.7 V8 4x4	162/ 164	EVA	Flexible fuel	04/99-04/03	VK20	5604	1.1	-	IK20TT	IK20TT	8
GRAND CHEROKEE III (05-10)											
3.0 CRD 4x4	155/ 160	EXL		06/05-12/10	DG-194		4.4V				6
3.7 V6 4x4	148/ 157	EKG		06/05-12/10	KJ20CR-L11	3169	1.1	K20TT	IK20TT	IK20TT	6
4.7 V8 4x4	170	EVA-231		06/05-05/07	KJ16CR-L11	3132	1.1	K16TT	IK16TT	IK16TT	8
5.7 V8 4x4	240/ 259	EZB; EZD; EZH		06/05-12/10	ITL16	5349	1.1	-	ITL16TT	ITL16TT	8
6.1 SRT8 4x4	313	ESF		03/06-01/09	ITL20	5350	1.1	-	-	-	8
GRAND CHEROKEE IV (10-)											
3.0 CRD V6 4x4	140/ 177	EXF		02/11-03/13	DG-194		4.4V				6
3.6 V6 4x4	210	ERB		11/10-	ITV20	5339	1.1	-	ITV20TT	ITV20TT	6
3.6 V6 FlexFuel 4x4	210	ERB		11/10-	ITV20	5339	1.1	-	ITV20TT	ITV20TT	6
5.7 V8 4x4	259	EZH		11/10-	ITL16	5349	1.1	-	ITL16TT	ITL16TT	16
PATRIOT (07-)											
2.0 CRD	103	ECD; ECE	Particle filter(-)	02/07-	DG-190		4.4V				4
2.0 CRD 4x4	103	ECD; ECE	Particle filter(-)	02/07-	DG-190		4.4V				4
2.4 4x4	125	ED3		01/08-	KJ16CR-U11	3311	1.1	K16TT	IK16TT	IK16TT	4
WRANGLER I (86-96)											
2.5	76/89	EPE		01/88-08/96	KJ16CR-L11	3132	1.1	K16TT	IK16TT	IK16TT	4
4.0	131	ERH		12/91-08/96	KJ16CR-L11	3132	1.1	K16TT	IK16TT	IK16TT	6
4.2	84	6L		08/86-08/89	QJ16AR-U	3235	0.8	-	-	-	6
4.2 2WD	82			10/86-09/90	QJ16AR-U	3235	0.8	-	-	-	6
WRANGLER II (96-08)											
2.4	105	ED		11/02-04/07	ITL16	5349	1.1	-	ITL16TT	ITL16TT	4
2.5	87	P00		08/96-04/07	KJ16CR-L11	3132	1.1	K16TT	IK16TT	IK16TT	4
3.8	153	EGT(208)		02/06-12/08	ITL16	5349	1.1	-	ITL16TT	ITL16TT	6
4.0	124/ 130	ERH(169)		08/96-04/07	KJ16CR-L11	3132	1.1	K16TT	IK16TT	IK16TT	6
4.0 Rubicon	128	ERH-177		08/03-04/07	KJ16CR-L11	3132	1.1	K16TT	IK16TT	IK16TT	6

	KW					Standard			Twin Tip			QTY
JEEP <i>continued</i>												
WRANGLER III (07-)												
3.6 V6	209	ERB		10/11-	ITV20	5339	1.1	-	ITV20TT	ITV20TT		6
3.8	146	EGT		04/07-	ITL20	5350	1.1	-	-	-		6
KIA												
AVELLA (95-01)												
1.5	55	B5-16V		12/98-12/99	W16EPR-U11	3201	1.1	W16TT	IW16TT	IW16TT		4
BESTA (96-)												
2.2 D	48	R2		02/96-	DG-146		11V					4
CARENS I (00-02)												
1.8 i	81	T8		11/00-07/02	K20PR-U	3145	0.8	K20TT	IK20TT	IK20TT		4
CARENS II (02-)												
1.6	77	GA6D		07/02-05/06	K20PR-U11	3121	1.1	K20TT	IK20TT	IK20TT		4
1.8	93	TB		07/02-05/06	K20PR-U11	3121	1.1	K20TT	IK20TT	IK20TT		4
2.0 CRDi	83/103	D4EA		07/02-	DG-173		11V					4
2.0 CVVT	102	G4GC		08/04-12/06	K16PR-U11	3130	1.1	K16TT	IK16TT	IK16TT		4
2.0 CVVT	102	G4GC		09/06-	SK16PR-L11	3395	1.1	-	IK16TT	IK16TT		4
CARENS III (06-)												
1.6 CRDi 110	85	D4FB		10/10-	DG-602		11V					4
1.6 CRDi 128	94	D4FB		10/10-	DG-602		11V					4
1.6 CVVT	93/97	G4FC		08/09-	XU22HDR9	3445	0.9	XUH22TT	-	VXUH22		4
2.0 CRDi 115	85	D4EA		05/07-	DG-173		11V					4
2.0 CRDi 135	100	D4EA		08/09-	DG-173		11V					4
2.0 CRDi 140	103	D4EA		09/06-	DG-173		11V					4
2.0 CVVT	106	G4KA(144)		09/06-	K16PR-U11	3130	1.1	K16TT	IK16TT	IK16TT		4
CARENS IV (13-)												
1.6	99	G4FD		03/13-	VXUH20I			-	-	VXUH20I		4
1.7 CRDi	85/100	D4FD-L		03/13-	DG-602		11V					4
2.0	130	G4NC		03/13-	VXUH22I	5656	0.9	-	-	VXUH22I		4
2.0 GDi	122	G4NC		03/13-	VXUH22I	5656	0.9	-	-	VXUH22I		4
CARNIVAL I (99-01)												
2.5 V6	121	KRV6		08/99-10/01	PK20PR-L11	3142	1.1	-	IK20TT	IK20TT		6
2.9 TD	93	J3		08/99-10/01	DG-172		11V					4
2.9 TD	93	J3	OE: 3671042500	08/99-10/01	DG-174		11V					4
CARNIVAL II (99-)												
2.5 V6	110	K5		10/01-	PK20PR-L11	3142	1.1	-	IK20TT	IK20TT		6
2.9 CRDi	106	J3	OE: 3671042500	10/01-	DG-174		11V					4
2.9 CRDi	106	J3	OE: 3671042510	10/01-	DG-172		11V					4
2.9 TD	93	J3	OE: 3671042500	01/99-	DG-174		11V					4
2.9 TD	93	J3	OE: 3671042510	01/99-	DG-172		11V					4
3.5	143	6G72		07/02-02/06	PK16PR-L11	3275	1.1	-	IK16TT	IK16TT		6
CARNIVAL III (06-)												
2.2 CRDi	143	D4HB	OE: 3671042500	01/10-	DG-174		11V					4
2.7 V6	139	G6EA(188)		06/06-	SK16PR-L11	3395	1.1	-	IK16TT	IK16TT		6
2.9 CRDi	136	J3		06/06-	DG-172		11V					4
2.9 CRDi	136	J3	OE: 3671042500	06/06-	DG-174		11V					4
CEED (06-)												
1.4	77/80	G4FA		02/09-	XU22HDR9	3445	0.9	XUH22TT	-	VXUH22		4
1.4	77/80	G4FA	14 mm diameter+	12/06-01/09	KJ16CR-U11	3311	1.1	K16TT	IK16TT	IK16TT		4
1.4 CVVT	66	G4FA-L		06/10-	XU22HDR9	3445	0.9	XUH22TT	-	VXUH22		4
1.6	85/90/93	G4FC		02/09-	XU22HDR9	3445	0.9	XUH22TT	-	VXUH22		4
1.6	85/90/93	G4FC	14 mm diameter+	09/07-01/09	KJ16CR-U11	3311	1.1	K16TT	IK16TT	IK16TT		4
1.6 CRDi 115	85	D4FB		12/06-11/09	DG-173		11V					4
1.6 CRDi 128	94	D4FB		10/10-	DG-602		11V					4
1.6 CRDi 90	66	D4FB-L		12/06-11/11	DG-173		11V					4
1.6 CVVT	92	G4FC		06/09-	XU22HDR9	3445	0.9	XUH22TT	-	VXUH22		4
2.0	105	G4GC		12/06-	SK16PR-L11	3395	1.1	-	IK16TT	IK16TT		4
2.0 CRDi 140	103	D4EA-F		09/07-11/09	DG-173		11V					4
CEED (12-)												
1.4 CRDi	66	D4FC		09/12-	DG-602		11V					4

Spark & Glow Plugs

Application Tables

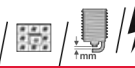





	KW										QTY
KIA <i>continued</i>											
CEED (12-) <i>continued</i>											
1.4 CRDi 90	66	D4FC		05/12-	DG-602		11V				4
1.4 CVT	66/73	G4FA-L		05/12-	XU22HDR9	3445	0.9	XUH22TT	-	VXUH22	4
1.6 CRDi	81/94	D4FB		09/12-	DG-602		11V				4
1.6 CRDi 110	81	D4FB		05/12-	DG-602		11V				4
1.6 CRDi 115	85	D4FB		05/12-	DG-602		11V				4
1.6 CRDi 128	94	D4FB		05/12-	DG-602		11V				4
1.6 CRDi 90	66	D4FB-L		05/12-	DG-602		11V				4
1.6 CVT	92	G4FC		05/12-	XU22HDR9	3445	0.9	XUH22TT	-	VXUH22	4
1.6 GDI	99	G4FD		05/12-	VXUH20I			-	-	VXUH20I	4
CERATO (04-)											
1.5 CRDi	75	D4FA		07/05-	DG-602		11V				4
1.6	77	G4ED		04/04-12/08	K16PR-U11	3130	1.1	K16TT	IK16TT	IK16TT	4
1.6	90	G4FC(122)		05/06-12/08	KJ16CR-U11	3311	1.1	K16TT	IK16TT	IK16TT	4
1.6 CRDi	85	D4FB		06/05-12/08	DG-173		11V				4
2.0	105	G4GC(143)		04/04-12/08	K16PR-U11	3130	1.1	K16TT	IK16TT	IK16TT	4
2.0 CRDi	83	D4EA		04/04-	DG-173		11V				4
CERATO (09-)											
1.6	90/93	G4FC		01/10-	XU22HDR9	3445	0.9	XUH22TT	-	VXUH22	4
1.6 CVT	91	G4FC		02/09-	XU22HDR9	3445	0.9	XUH22TT	-	VXUH22	4
CLARUS (96-)											
1.8 i 16V	85	T8		07/96-07/01	K16PR-U	3191	0.8	K16TT	IK16TT	IK16TT	4
2.0 i 16V	98	FE (16V)		07/96-07/01	K20PR-U11	3121	1.1	K20TT	IK20TT	IK20TT	4
JOICE (00-)											
2.0	88/102	G4; G4CPD		02/00-03/03	W20EPR-S11	3046	1.1	W20TT	IW20TT	IW20TT	4
K2500 (03-)											
2.5 D	69	D4BH		01/03-09/07	DG-172		11V				4
2.5 D	69	D4BH		10/07-	DG-198		11V				4
K2700 (99-)											
2.7 D	59	J2		10/99-09/04	DG-146		11V				4
MAGENTIS (01-)											
2.0	100	G4JP		05/01-12/05	W20EPR-U11	3049	1.1	W20TT	IW20TT	IW20TT	4
2.5 V6	124	G6BV		05/01-12/05	PK16PR-L11	3275	1.1	-	IK16TT	IK16TT	6
MAGENTIS (05-)											
2.0	121	G4KA(164)		07/09-08/10	K16HPR-U11	6076	1.1	KH16TT	IKH16TT	IKH16TT	4
2.0	106	G4KA(144)		11/05-05/08	K16PR-U11	3130	1.1	K16TT	IK16TT	IK16TT	4
2.0	106	G4KA(144)	OEM Optional	11/05-05/08	PK16PR-L11	3275	1.1	-	IK16TT	IK16TT	4
2.0 CRDi	103/110	D4EA		04/06-08/10	DG-173		11V				4
2.7	138	G6EA(188)		11/05-05/08	VKH16	5617	1.1	-	IKH16TT	IKH16TT	6
2.7 V6	142	G6EA(193)		07/09-08/10	VKH16	5617	1.1	-	IKH16TT	IKH16TT	6
OPIRUS (03-)											
3.5	149	6G74(197);6G74(203)		09/03-10/06	PK16PR-L11	3275	1.1	-	IK16TT	IK16TT	6
3.8 V6	196	3.8 V6(266)		10/06-10/07	SK16PR-L11	3395	1.1	-	IK16TT	IK16TT	6
OPTIMA (11-)											
1.7 CRDi	100	D4FD-L		03/12-	DG-602		11V				4
2.0	125	G4KD		03/12-	VXUH22I	5656	0.9	-	-	VXUH22I	4
2.0 CVVL	121	G4KD		03/12-	VXUH22I	5656	0.9	-	-	VXUH22I	4
2.4	132/149	G4KJ		03/12-	K16HPR-U11	6076	1.1	KH16TT	IKH16TT	IKH16TT	4
2.4 Hybrid	154			09/11-	K16HPR-U11	6076	1.1	KH16TT	IKH16TT	IKH16TT	4
PICANTO (04-)											
1.0	45/46	G4HE		04/04-04/11	K16PR-U11	3130	1.1	K16TT	IK16TT	IK16TT	4
1.1	48	G4HG		04/04-01/11	K16PR-U11	3130	1.1	K16TT	IK16TT	IK16TT	4
1.1 CRDi	55	D3FA		11/05-	DG-602		11V				3
PICANTO (11-)											
1.0	51	G3LA		05/11-	XUH20TTi	7006	0.8	XUH20TTi	-	VXUH20i	3
1.0 Bi-Fuel	60	B3LA		05/11-	XUH20TTi	7006	0.8	XUH20TTi	-	VXUH20i	3
1.0 LPG	49	B3LA		08/13-	XUH20TTi	7006	0.8	XUH20TTi	-	VXUH20i	3
1.2	63	G4LA		09/11-	XUH20TTi	7006	0.8	XUH20TTi	-	VXUH20i	4
1.2	63	G4LA	OEM Optional	09/11-	IXUH20I			-	-	VXUH20I	4
PREGIO (95-)											
2.5 D	69	D4BH		08/95-09/04	DG-301		11V				4
2.5 Tci D	69	D4BH		09/02-	DG-301		11V				4
2.7 D	60	J2		10/97-	DG-146		11V				4
PRIDE (90-)											
1.1 i	38	B1		02/94-09/94	W16EPR-U11	3201	1.1	W16TT	IW16TT	IW16TT	4
1.3	47	B3-EGI		08/99-07/00	W16EPR-U11	3201	1.1	W16TT	IW16TT	IW16TT	4







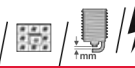





	KW								QTY		
KIA continued											
PRIDE (90-) continued											
1.3 16V	44/47/53	B3;B3-EGI; B3-EGI		01/90-07/00	W16EPR-U11	3201	1.1	W16TT	IW16TT	IW16TT	4
1.3 i	51	B3-EGI		10/94-07/00	W16EPR-U11	3201	1.1	W16TT	IW16TT	IW16TT	4
PRO CEED (08-)											
1.4	77/80	G4FA		02/09-	XU22HDR9	3445	0.9	XUH22TT	-	VXUH22	4
1.4	77/80	G4FA	14 mm diameter+	02/08-01/09	KJ16CR-U11	3311	1.1	K16TT	IK16TT	IK16TT	4
1.4 CVVT	66	G4FA-L		06/10-	XU22HDR9	3445	0.9	XUH22TT	-	VXUH22	4
1.6	90/93	G4FC		02/08-11/09	KJ16CR-U11	3311	1.1	K16TT	IK16TT	IK16TT	4
1.6	90/93	G4FC		12/09-	XU22HDR9	3445	0.9	XUH22TT	-	VXUH22	4
1.6 CRDi 115	85	D4FB		02/08-11/09	DG-173		11V				4
1.6 CRDi 128	94	D4FB		10/10-	DG-602		11V				4
1.6 CRDi 90	66	D4FB-L		02/08-11/09	DG-173		11V				4
1.6 CVVT	92	G4FC		10/10-	XU22HDR9	3445	0.9	XUH22TT	-	VXUH22	4
2.0	105	G4GC		02/08-	SK16PR-L11	3395	1.1	-	IK16TT	IK16TT	4
2.0 CRDi 140	103	D4EA-F		02/08-11/09	DG-173		11V				4
PRO CEED (13-)											
1.4 CRDi	66	D4FC		03/13-	DG-602		11V				4
1.6 CRDi	81/94	D4FB		03/13-	DG-602		11V				4
1.6 GDI	99	G4FD		03/13-	VXUH20I			-	-	VXUH20I	4
RETONA (99-)											
2.0 TD	61	RF		06/99-	DG-146		11V				4
RIO I (00-05)											
1.3	55/60	MI-TECH-S82; MI-TECH-SOH		08/02-02/05	W16EXR-U11	3032	1.1	W16TT	IW16TT	IW16TT	4
1.5 16V	72	A5D		08/00-02/05	K20PR-U	3145	0.8	K20TT	IK20TT	IK20TT	4
1.5 16V	71/72	MI-TECH-DOH		09/00-02/05	W16EXR-U11	3032	1.1	W16TT	IW16TT	IW16TT	4
RIO II (05-)											
1.4 16V	71	1.4L-ALPHA;G4EE; G4EE; 1.4L-ALPHA(97)		03/05-	K16PR-U11	3130	1.1	K16TT	IK16TT	IK16TT	4
1.5 CRDi	65/81	D4FA		03/05-	DG-602		11V				4
1.6 16V	82	1.6L-ALPHA;G4GD		03/05-	K16PR-U11	3130	1.1	K16TT	IK16TT	IK16TT	4
1.6 CVVT	82	1.6L-ALPHA;G4GD		03/05-	K16PR-U11	3130	1.1	K16TT	IK16TT	IK16TT	4
RIO III (11-)											
1.1 CRDi	55	D3FA		09/11-	DG-602		11V				3
1.25 CVVT	63/65	G4LA		09/11-	XUH20TTi	7006	0.8	XUH20TTi	-	VXUH20i	4
1.25 CVVT	63/65	G4LA	OEM Optional	09/11-	IXUH20I			-	-	VXUH20I	4
1.25 LPG	63			09/11-	VXUH20I			-	-	VXUH20I	4
1.4 CRDi	66	D4FC		09/11-	DG-602		11V				4
1.4 CVVT	79/80	G4FA		09/11-	XU22HDR9	3445	0.9	XUH22TT	-	VXUH22	4
1.6 CVVT	90	G4FC		06/12-	XU22HDR9	3445	0.9	XUH22TT	-	VXUH22	4
SEPHIA (93-97)											
1.5 i	59	B5		02/96-10/97	W16EPR-U11	3201	1.1	W16TT	IW16TT	IW16TT	4
1.6 i	59	B6		09/93-10/97	W16EPR-U11	3201	1.1	W16TT	IW16TT	IW16TT	4
1.8 i 16V	82	OK24N; OK26Y		01/95-10/97	K16PR-U	3191	0.8	K16TT	IK16TT	IK16TT	4
SHUMA I (96-01)											
1.5	59	B5		09/98-12/98	K16PR-U11	3130	1.1	K16TT	IK16TT	IK16TT	4
1.5 i 16V	65	B5-16V		10/97-10/01	K16PR-U11	3130	1.1	K16TT	IK16TT	IK16TT	4
1.8 i 16V	81	T8		10/97-08/98	K16PR-U	3191	0.8	K16TT	IK16TT	IK16TT	4
1.8 i 16V	81	T8		09/98-03/01	K20PR-U	3145	0.8	K20TT	IK20TT	IK20TT	4
SHUMA II (01-04)											
1.6	75	GA6D(101)		05/01-08/04	K16PR-U11	3130	1.1	K16TT	IK16TT	IK16TT	4
1.8	84	T8		04/03-08/04	K20PR-U	3145	0.8	K20TT	IK20TT	IK20TT	4
SORENTO I (02-)											
2.4	102	G4JS		08/02-	P16PR11	3114	1.1	W16TT	IW16TT	IW16TT	4
2.5 CRDi	103/120/125	D4CB		08/02-	DG-189		11V				4
3.3 V6	177	33L(241)		12/06-08/09	PK16PR-L11	3275	1.1	-	IK16TT	IK16TT	6
3.3 V6 4WD	182	G6DB		11/07-08/09	PK16PR-L11	3275	1.1	-	IK16TT	IK16TT	6
3.5 V6	143	G6CU		08/02-05/06	PK16PR-L11	3275	1.1	-	IK16TT	IK16TT	6
SORENTO II (09-)											
2.4 CVVT	141	THETA 2 GDI		10/12-	FXU16HR11		1.1	-	-	FXU16HR11	4
2.4 CVVT	128	G4KE		11/09-	K16HPR-U11	6076	1.1	KH16TT	IKH16TT	IKH16TT	4
2.4 CVVT	141	G4KJ	Eng: THETA 2 MPI>	10/12-	K16HPR-U11	6076	1.1	KH16TT	IKH16TT	IKH16TT	4
2.4 CVVT 4WD	141	THETA 2 GDI		10/12-	FXU16HR11		1.1	-	-	FXU16HR11	4
2.4 CVVT 4WD	128	G4KE		11/09-	K16HPR-U11	6076	1.1	KH16TT	IKH16TT	IKH16TT	4







Spark & Glow Plugs

Application Tables

KW	KW	KW	NOTE	21	Standard			Twin Tip			QTY
					Standard	Standard	Standard	Twin Tip	Twin Tip	Twin Tip	
KIA continued											
SORENTO II (09-) continued											
2.4 CVVT 4WD	141	G4KJ	Eng: THETA 2 MPI>	10/12-	K16HPR-U11	6076	1.1	KH16TT	IKH16TT	IKH16TT	4
2.4 GDI	141	THETA 2 GDI		10/12-	FXU16HR11		1.1	-	-	FXU16HR11	4
2.4 GDI	141	G4KJ	Eng: THETA 2 MPI>	10/12-	K16HPR-U11	6076	1.1	KH16TT	IKH16TT	IKH16TT	4
2.4 GDI 4WD	141	THETA 2 GDI		10/12-	FXU16HR11		1.1	-	-	FXU16HR11	4
2.4 GDI 4WD	141	G4KJ	Eng: THETA 2 MPI>	10/12-	K16HPR-U11	6076	1.1	KH16TT	IKH16TT	IKH16TT	4
SOUL I (09-)											
1.6	91	G4FG		09/09-12/10	XU22HDR9	3445	0.9	XUH22TT	-	VXUH22	4
1.6 CRDi 115	85	D4FB		02/09-	DG-602		11V				4
1.6 CRDi 128	94	D4FB		02/09-	DG-602		11V				4
1.6 CVVT	93/95	G4FC		02/09-	XU22HDR9	3445	0.9	XUH22TT	-	VXUH22	4
1.6 GDI	103	G4FD		06/11-	VXUH20I			-	-	VXUH20I	4
SOUL II (14-)											
1.6 CRDi 128	94	D4FB		02/14-	DG-602		11V				4
1.6 GDI	97	G4FD		02/14-	VXUH20I			-	-	VXUH20I	4
SPORTAGE I (94-04)											
2.0	87	FE (16V)		10/00-08/03	K20PR-U11	3121	1.1	K20TT	IK20TT	IK20TT	4
2.0 4WD	87	FE (16V)		10/00-08/03	K20PR-U11	3121	1.1	K20TT	IK20TT	IK20TT	4
2.0 i 16V	94	FE (16V)		10/99-08/03	K20PR-U11	3121	1.1	K20TT	IK20TT	IK20TT	4
2.0 i 16V 4WD	94	FE (16V)		04/94-08/03	K20PR-U11	3121	1.1	K20TT	IK20TT	IK20TT	4
2.0 i 4WD	70	FE (8V)		04/94-08/99	K16PR-U	3191	0.8	K16TT	IK16TT	IK16TT	4
2.0 TD 4WD	61	RF		10/97-08/03	DG-146		11V				4
SPORTAGE II (04-)											
2.0 16V 4WD	104	G4GC		09/04-12/06	K16PR-U11	3130	1.1	K16TT	IK16TT	IK16TT	4
2.0 16V 4WD	104	G4GC		09/06-	SK16PR-L11	3395	1.1	-	IK16TT	IK16TT	4
2.0 CRDi	83/103/110	D4EA-V		02/05-	DG-173		11V				4
2.0 CRDi 4WD	83/103/110	D4EA-F; D4EA-V		09/04-	DG-173		11V				4
2.0 i 16V	104	G4GC		09/04-12/06	K16PR-U11	3130	1.1	K16TT	IK16TT	IK16TT	4
2.0 i 16V	104	G4GC		09/06-	SK16PR-L11	3395	1.1	-	IK16TT	IK16TT	4
2.7 V6 4WD	129	G6BA(175)		09/04-08/06	PK16PR-L11	3275	1.1	-	IK16TT	IK16TT	6
2.7 V6 4WD	129	G6BA(175)		09/06-	SK16PR-L11	3395	1.1	-	IK16TT	IK16TT	6
SPORTAGE III (10-)											
1.6 GDI	99	G4FD		02/11-	VXUH20I			-	-	VXUH20I	4
1.7 CRDi	85	D4FD-L		12/10-	DG-602		11V				4
2.0 CVVT	120	G4KD		07/10-	K16HPR-U11	6076	1.1	KH16TT	IKH16TT	IKH16TT	4
2.0 CVVT AWD	120/122	G4KD; THETA 2 MPI		07/10-	K16HPR-U11	6076	1.1	KH16TT	IKH16TT	IKH16TT	4
2.0 CVVT AWD	122	G4NC	Eng: NU MPI/GDI>	07/10-	VXUH22I	5656	0.9	-	-	VXUH22I	4
2.0 GDI	122	THETA 2 MPI		02/14-	K16HPR-U11	6076	1.1	KH16TT	IKH16TT	IKH16TT	4
2.0 GDI	122	G4NC	Eng: NU MPI/GDI>	02/14-	VXUH22I	5656	0.9	-	-	VXUH22I	4
2.0 GDI AWD	122	THETA 2 MPI		02/14-	K16HPR-U11	6076	1.1	KH16TT	IKH16TT	IKH16TT	4
2.0 GDI AWD	122	G4NC	Eng: NU MPI/GDI>	02/14-	VXUH22I	5656	0.9	-	-	VXUH22I	4
VENGA (10-)											
1.4 CRDi 75	55/57	D4FC		02/10-	DG-602		11V				4
1.4 CRDi 90	66	D4FC		02/10-	DG-602		11V				4
1.4 CVVT	66	G4FA-L		02/10-	XU22HDR9	3445	0.9	XUH22TT	-	VXUH22	4
1.6 CRDi 115	85	D4FB		02/10-	DG-602		11V				4
1.6 CRDi 128	94	D4FB		02/10-	DG-602		11V				4
1.6 CVVT	92	G4FC		02/10-	XU22HDR9	3445	0.9	XUH22TT	-	VXUH22	4
KTM											
X-BOW (08-)											
2.0 R	220	CDLA		07/10-	PK22PR8	3273	0.8	-	-	VK22	4
LADA											
110 (95-)											
1.5	54/56/57	BA3 2111; VAZ-2111		01/95-01/09	W20EPR-U	3047	0.8	W20TT	IW20TT	IW20TT	4
1.5 16V	67/70	VAZ2112; VAZ-2112		01/95-01/07	Q20PR-U11	3008	1.1	Q20TT	IQ20TT	IQ20TT	4
1.6	66	VAZ-21124		01/00-	Q20P-U11	3136	1.1	Q20TT	IQ20TT	IQ20TT	4
1.6	60	VAZ-21114		01/00-10/08	W20EPR-U	3047	0.8	W20TT	IW20TT	IW20TT	4
2.0 i	110	C 20 XE		08/96-	K20PR-U	3145	0.8	K20TT	IK20TT	IK20TT	4







	KW								QTY		
LADA continued											
111 (95-)											
1.5	56/57/58	VAZ-2111		10/00-01/09	W20EPR-U	3047	0.8	W20TT	IW20TT	IW20TT	4
1.5 16V	67/70	VAZ2112; VAZ-2112		01/95-01/09	Q20PR-U11	3008	1.1	Q20TT	IQ20TT	IQ20TT	4
1.6	60/66	VAZ-21124		01/05-	Q20P-U11	3136	1.1	Q20TT	IQ20TT	IQ20TT	4
1.6	60	VAZ-21114		01/05-	W20EPR-U	3047	0.8	W20TT	IW20TT	IW20TT	4
112 (95-)											
1.5	54/56/57	VAZ-2111; VAZ21083		01/95-01/08	W20EPR-U	3047	0.8	W20TT	IW20TT	IW20TT	4
1.5 16V	67/70	VAZ2112; VAZ-2112		01/95-01/08	Q20PR-U11	3008	1.1	Q20TT	IQ20TT	IQ20TT	4
1.6	60/66	VAZ-21124		01/05-	Q20P-U11	3136	1.1	Q20TT	IQ20TT	IQ20TT	4
1.6	60	VAZ-21114		01/05-	W20EPR-U	3047	0.8	W20TT	IW20TT	IW20TT	4
1200-1500 (73-85)											
1200 (VAZ, WAS2102)	44	BA3 2101		09/73-08/84	W20EPR-U	3047	0.8	W20TT	IW20TT	IW20TT	4
1500 (VAZ2102)	54	BA3 2103		09/73-06/85	W20EPR-U	3047	0.8	W20TT	IW20TT	IW20TT	4
1200-1600 (70-90)											
1200 L/S (VAZ, WAS2101)	44	BA3 2101		01/70-06/86	W20EPR-U	3047	0.8	W20TT	IW20TT	IW20TT	4
1300 (VAZ2101)	48	BA3 21011		05/78-01/81	W20EPR-U	3047	0.8	W20TT	IW20TT	IW20TT	4
1300 (WAS21011)	51	BA3 2105		08/74-08/84	W20EPR-U	3047	0.8	W20TT	IW20TT	IW20TT	4
1500 (WAS2103, WAS2106)	55	BA3 2103		09/72-08/84	W20EPR-U	3047	0.8	W20TT	IW20TT	IW20TT	4
1500 N/S (VAZ2103)	55	VAZ21043		11/75-10/86	W20EPR-U	3047	0.8	W20TT	IW20TT	IW20TT	4
1600 (2106)	56	BA3 2103		01/84-01/90	W20EP-U	3043	0.8	W20TT	IW20TT	IW20TT	4
1600 (WAS2106)	58	BA3 2106		09/72-08/84	W20EP-U	3043	0.8	W20TT	IW20TT	IW20TT	4
1600 N/L (VAZ2103)	57	BA3 2106		03/79-10/86	W20EP-U	3043	0.8	W20TT	IW20TT	IW20TT	4
GRANTA (11-)											
1.6	72	VAZ-21126		10/11-	Q20PR-U11	3008	1.1	Q20TT	IQ20TT	IQ20TT	4
1.6	60/64	VAZ-11186		10/11-	W20EPR-U11	3049	1.1	W20TT	IW20TT	IW20TT	4
KALINA (04-)											
1.4 16V	66	VAZ-11194		11/08-	Q20PR-U11	3008	1.1	Q20TT	IQ20TT	IQ20TT	4
1.4 16V LPG	65	VAZ-11194		11/08-	VQ20	5602	1.1	-	IQ20TT	IQ20TT	4
1.6	60/62	VAZ-21124		10/04-	Q20P-U11	3136	1.1	Q20TT	IQ20TT	IQ20TT	4
1.6	60	VAZ-21114		10/04-	W20EPR-U	3047	0.8	W20TT	IW20TT	IW20TT	4
1.6 16V	66			10/04-	Q20PR-U11	3008	1.1	Q20TT	IQ20TT	IQ20TT	4
1.6 16V	66			10/04-	Q20P-U11	3136	1.1	Q20TT	IQ20TT	IQ20TT	4
LARGUS (12-)											
1.6	62/77		Flexible fuel	03/12-	K20PR-U	3145	0.8	K20TT	IK20TT	IK20TT	4
NIVA (2121) (76-)											
1600	54/56	BA3 2121		12/76-03/95	W20EPR-U	3047	0.8	W20TT	IW20TT	IW20TT	4
1700 i	59	VAZ21044		06/96-	W20EPR-U	3047	0.8	W20TT	IW20TT	IW20TT	4
1700 i 4x4	60/61	VAZ21044; VAZ21214		10/00-	W20EPR-U	3047	0.8	W20TT	IW20TT	IW20TT	4
1900 Diesel	47/55	XUD9A; XUD9SD		01/93-	DG-001		11V				4
NIVA II (2123) (02-)											
1.7	61	VAZ21044		08/04-	W20EPR-U	3047	0.8	W20TT	IW20TT	IW20TT	4
1.7	59	BA3 21214		09/02-	W20EPR-U11	3049	1.1	W20TT	IW20TT	IW20TT	4
1.7 LPG	57	BA3 21214	LPG / GPL	09/02-	VW20	5606	1.1	-	IW20TT	IW20TT	4
NOVA (81-)											
1200 Junior/L (VAZ, WAS2105)	44	VAZ2101		09/81-01/86	W20EPR-U	3047	0.8	W20TT	IW20TT	IW20TT	4
1300	48	BA3 2105		09/85-12/91	W20EPR-U	3047	0.8	W20TT	IW20TT	IW20TT	4
1300 Spezial/L (VAZ, WAS2105)	48	BA3 2105		05/81-12/86	W20EPR-U	3047	0.8	W20TT	IW20TT	IW20TT	4
1500	49/55	VAZ21043		09/85-01/96	W20EPR-U	3047	0.8	W20TT	IW20TT	IW20TT	4
1500 S (WAS21093)	52	VAZ21043		06/89-	W20EPR-U	3047	0.8	W20TT	IW20TT	IW20TT	4
1500 Special (VAZ2105, WAS21053)	55	VAZ21043		03/85-	W20EPR-U	3047	0.8	W20TT	IW20TT	IW20TT	4
1600 (WAS21074)	56	BA3 2106		01/88-10/01	W20EP-U	3043	0.8	W20TT	IW20TT	IW20TT	4
1700	62	VAZ21044	Check Hex size	08/94-	W20EPR-U	3047	0.8	W20TT	IW20TT	IW20TT	4
1700 i Classic (VAZ2107)	62	VAZ21044		06/96-	W20EPR-U	3047	0.8	W20TT	IW20TT	IW20TT	4
OKA (88-)											
0.8	26			02/88-	Q20R-U	3140	0.8	Q20TT	IQ20TT	IQ20TT	2
PRIORA (2170, 2171, 2172) (08-)											
1.6	60/72	VAZ-21126		12/08-	Q20PR-U11	3008	1.1	Q20TT	IQ20TT	IQ20TT	4
1.6 LPG	71	VAZ-21126		12/08-	VQ20	5602	1.1	-	IQ20TT	IQ20TT	4
SAMARA (86-)											
1100	39/43	BA3 21081		02/88-	W20EPR-U	3047	0.8	W20TT	IW20TT	IW20TT	4







	KW												QTY
LADA <i>continued</i>													
SAMARA (86-) <i>continued</i>													
1300	45/ 46/ 48/ 50	BA3 2108; BA3 21115		07/91-	W20EPR-U	3047	0.8		W20TT	IW20TT	IW20TT		4
1500	50/ 52/ 53	BA3 21083; BA3 2111		01/88-	W20EPR-U	3047	0.8		W20TT	IW20TT	IW20TT		4
1500	50/ 52/ 53	BA3 21083; BA3 2111		07/91-	W20EP-U	3043	0.8		W20TT	IW20TT	IW20TT		4
TOSCANA (83-12)													
1500 (VAZ2107)	55	VAZ21043		09/83-10/86	W20EPR-U	3047	0.8		W20TT	IW20TT	IW20TT		4
LAMBORGHINI													
COUNTACH (74-91)													
LP400	283			01/74-12/82	IW24	5316	0.7	-	-	-	-		12
LP500 S	276			01/82-12/85	IW24	5316	0.7	-	-	-	-		12
S Quattrovalvole	313	L 507		01/85-12/91	IX24	5372	0.8	-	-	-	-		12
DIABLO (90-)													
5.7	361/ 390			03/90-12/00	IXU27	5337	0.9	-	-	-	-		12
6.0	434			04/00-08/03	IXU27	5337	0.9	-	-	-	-		12
GT 2	470			01/98-	IXU27	5337	0.9	-	-	-	-		12
GT 5.9	423			10/99-	IXU27	5337	0.9	-	-	-	-		12
SE	386			01/94-12/96	IXU27	5337	0.9	-	-	-	-		12
SV	390			01/98-	IXU27	5337	0.9	-	-	-	-		12
VT	390			08/98-	IXU27	5337	0.9	-	-	-	-		12
VT All-wheel Drive	361			01/90-08/98	IXU27	5337	0.9	-	-	-	-		12
ESPADA (68-81)													
400 GT	257			01/68-12/81	IW24	5316	0.7	-	-	-	-		12
GALLARDO (03-)													
5.0	368/ 382	L 510		08/03-	IK27	5312	0.8	-	-	-	-		10
LM-002 (83-92)													
5.2	330			08/85-12/92	IX24	5372	0.8	-	-	-	-		12
MIURA (69-72)													
P400 S	272			01/69-12/72	IW27	5317	0.7	-	-	-	-		12
LANCIA													
BETA (73-86)													
2000	88	828B1.000		04/76-12/84	W20EPR-U	3047	0.8		W20TT	IW20TT	IW20TT		4
2000 (828BS1)	88	828B1.000		05/76-11/79	W20EPR-U	3047	0.8		W20TT	IW20TT	IW20TT		4
2000 (828CB1)	85/88	828B1.000		04/76-07/82	W20EPR-U	3047	0.8		W20TT	IW20TT	IW20TT		4
2000 i.e.	90	LANC16		12/81-12/84	W20EPR-U	3047	0.8		W20TT	IW20TT	IW20TT		4
BETA H.P.E. (76-84)													
2000	85/88	828B1.000		05/76-09/84	W20EPR-U	3047	0.8		W20TT	IW20TT	IW20TT		4
2000 Volumex	99	828B1.000		07/83-09/84	W20EPR-U	3047	0.8		W20TT	IW20TT	IW20TT		4
BETA Monte Carlo (75-81)													
2.0	88	134A5000		09/75-05/81	W20EPR-U	3047	0.8		W20TT	IW20TT	IW20TT		4
DEDRA (89-99)													
1.6 (835EB)	66	159 B9.000		10/94-07/99	Q22PR-U	3010	0.8	-	-	-	VQ22		4
1.6 16V (835EI)	76	182 A4.000		01/96-07/99	K16PR-U	3191	0.8	K16TT	IK16TT	IK16TT			4
1.6 i.e. (835AA)	66	835 A1.000		08/89-06/94	W22EPR-U	3088	0.8	W22TT	-	-	VW22		4
1.6 i.e. (835AB)	57	835 A1.046		08/89-03/93	W20EPR-U	3047	0.8	W20TT	IW20TT	IW20TT			4
1.6 i.e. (835AN)	55	835 C1.000		04/93-07/99	Q22PR-U	3010	0.8	-	-	-	VQ22		4
1.6 LE (835EB) CAT	66	159 B9.000		07/94-07/99	Q22PR-U	3010	0.8	-	-	-	VQ22		4
1.8 16V LE (835FG)	83	182 A2.000		03/96-07/99	K20TNR	3304	1.0	K20TT	IK20TT	IK20TT			4
1.8 GT 16V (835EH)	96	183 A1.000		03/96-07/99	K20TNR	3304	1.0	K20TT	IK20TT	IK20TT			4
1.8 i.e. (835AC, 835BC)	80	835 A2.000		09/89-06/94	W20EPR-U	3047	0.8	W20TT	IW20TT	IW20TT			4
1.8 i.e. (835AT)	66	835 C5.000		08/93-07/99	Q22PR-U	3010	0.8	-	-	-	VQ22		4
1.8 i.e. (835BD, 835AD)	77	835 A2.046		09/89-07/99	W20EPR-U	3047	0.8	W20TT	IW20TT	IW20TT			4
1.8 i.e. (835FA)	74	836 A5.000		07/94-07/99	Q22PR-U	3010	0.8	-	-	-	VQ22		4
1.9 TDS (835EE, 835EF)	66	160 D1.000; 835 A4.000; 835 A4.046		04/89-07/99	DG-001		11V						4
2.0 16V (835ED)	102	836 A3.000		07/94-07/99	W22EPR-U	3088	0.8	W22TT	-	-	VW22		4
2.0 HF Integrale (835AP)	124	835 A7.046		11/90-07/94	W20EPB	5065	0.85	W20TT	IW20TT	IW20TT			4
2.0 i.e. (835AI)	86	835 A5.000		09/89-07/92	W20EPR-U	3047	0.8	W20TT	IW20TT	IW20TT			4
2.0 i.e. (835AL)	83	835 A5.046		09/89-07/99	W20EPR-U	3047	0.8	W20TT	IW20TT	IW20TT			4
2.0 i.e. Turbo (835AR)	119	835 A8.046		04/91-07/99	W20EPB	5065	0.85	W20TT	IW20TT	IW20TT			4
2.0 i.e. Turbo Integrale (835AO)	121	835 A7.000		05/90-07/94	K22PBR-S	5062	0.85	-	-	-	VK22		4
2.0 Integrale (835ED)	102	836 A3.000		07/94-07/99	W22EPR-U	3088	0.8	W22TT	-	-	VW22		4
2.0 Turbo (835AQ)	130	835 A8.000		11/90-06/94	K22PBR-S	5062	0.85	-	-	-	VK22		4







	KW					Standard		Twin Tip		QTY	
LANCIA continued											
DELTA I (79-94)											
1.1 (831AB.015)	47	831 B8.000		01/86-12/90	W20EPR-U	3047	0.8	W20TT	IW20TT	IW20TT	4
1.3	58	831 A2.000		09/83-08/92	W20EPR-U	3047	0.8	W20TT	IW20TT	IW20TT	4
1.5 (831AB.025)	63	831 B1.000		09/79-12/92	W22EPR-U	3088	0.8	W22TT	-	VW22	4
1.6 GT	77	831A4.000		11/82-04/86	W22EPR-U	3088	0.8	W22TT	-	VW22	4
1.6 GT i.e. (831AB.010)	66	149 C2.000		05/87-08/92	W20EPR-U	3047	0.8	W20TT	IW20TT	IW20TT	4
1.6 GT i.e. (831AB.016)	80	831 B7.000		08/86-08/88	W22EPR-U	3088	0.8	W22TT	-	VW22	4
1.6 HF Turbo	96	831 A7.000		10/83-12/86	W22EPR-U	3088	0.8	W22TT	-	VW22	4
1.6 HF Turbo (831AB.020)	103	831B3.000		08/86-08/88	W22EPR-U	3088	0.8	W22TT	-	VW22	4
1.6 HF Turbo (831AB.020S)	97	831 B7.046		04/87-03/89	W20EPBR-S	5067	0.85	W20TT	IW20TT	IW20TT	4
1.8 S4	184	LANC5		09/85-03/86	W20EPR-U	3047	0.8	W20TT	IW20TT	IW20TT	4
1.9 Turbo DS (831AB.021)	59	831 D1.000		10/86-12/89	DG-001		11V				4
2.0 16V HF Evo Integrale (831AB.027)	155	831 E5.046		06/93-01/94	W20EPBR-S	5067	0.85	W20TT	IW20TT	IW20TT	4
2.0 16V HF Integrale (831AB.026)	144	831 D5.000		03/89-09/91	W22EPB	5066	0.85	W22TT	-	VW22	4
2.0 HF Integrale (831AB.019)	122	831 B5.000		11/86-08/88	W22EPB	5066	0.85	W22TT	-	VW22	4
2.0 HF Integrale (831AB.024)	133	831 C5.000		10/87-02/89	W22EPB	5066	0.85	W22TT	-	VW22	4
2.0 HF Integrale (831AB.024S, 831AB.028)	130	831C5.046		08/88-12/92	W20EPB	5065	0.85	W20TT	IW20TT	IW20TT	4
DELTA II (93-99)											
1.4 i.e. (836AF, 836AH)	51	160 A1.046		10/94-08/99	W20EPR-U	3047	0.8	W20TT	IW20TT	IW20TT	4
1.6 i.e. (836AD)	55	835 C1.000		06/93-08/99	K22PBR-S	5062	0.85	-	-	VK22	4
1.6 i.e. (836AP)	66	182 A6.000		03/96-08/99	K20TNR	3304	1.0	K20TT	IK20TT	IK20TT	4
1.6 i.e. 16V (836AO)	76	182 A4.000		01/96-08/99	K22PBR-S	5062	0.85	-	-	VK22	4
1.8 i.e. (836AE)	76	835 C2.000		06/93-08/99	W22EPR-U	3088	0.8	W22TT	-	VW22	4
1.8 i.e. (836AG, 836AL)	66	836 A6.000		07/94-08/99	W20EPR-U	3047	0.8	W20TT	IW20TT	IW20TT	4
1.8 i.e. 16V (836AQ)	83	182 A2.000		03/96-08/99	K20TNR	3304	1.0	K20TT	IK20TT	IK20TT	4
1.8 i.e. 16V GT (836AR)	96	183 A1.000		03/96-08/99	K20TNR	3304	1.0	K20TT	IK20TT	IK20TT	4
1.9 TD (836AM, 836AN)	66	160 D1.000; 835 A4.000		10/94-08/99	DG-102		11V				4
2.0 16V (836AA, 836CA)	102	836 A3.000		06/93-08/99	W22EPR-U	3088	0.8	W22TT	-	VW22	4
2.0 16V Turbo (836AB)	137	836 A2.000		06/93-08/99	W22EPB	5066	0.85	W22TT	-	VW22	4
2.0 16V Turbo (836AS)	142	175 A4.000		07/96-08/99	K20PBR	5060	0.85	K20TT	IK20TT	IK20TT	4
DELTA III (08-)											
1.4	88/110	198A1.000; 198A4.000		09/08-	IXU27	5337	0.9	-	-	-	4
1.4 16V	103	198A7.000		07/10-	IXU27	5337	0.9	-	-	-	4
1.4 Bifuel	88	198 A4.000		07/11-	IXU27	5337	0.9	-	-	-	4
1.6 D Multijet	77/85/88	198 A2.000; 944 A 3.000; 955 A4.000		09/08-	DG-608		4.4V				4
1.9 D Multijet	140	844 A1.000		01/09-	DG-608		4.4V				4
2.0 D Multijet	120/121	198 A5.000; 198 A8.000; 844 A2.000		09/08-	DG-608		4.4V				4
GAMMA (81-84)											
2500	103	830A;830A000		08/81-12/84	W22EPR-U	3088	0.8	W22TT	-	VW22	4
KAPPA (94-01)											
2.0 16V Turbo (838AB1AA)	151	838 A4.000		02/95-10/01	W20EPBR-S	5067	0.85	W20TT	IW20TT	IW20TT	4
2.0 16V Turbo (838BB1AA)	151	838 A4.000		07/96-10/01	W20EPBR-S	5067	0.85	W20TT	IW20TT	IW20TT	4
2.0 16V Turbo (838CB)	151	838 A4.000		11/96-03/01	W20EPBR-S	5067	0.85	W20TT	IW20TT	IW20TT	4
2.0 20V (838AA1AA)	107	838 A1.000		10/94-10/01	K20TNR	3304	1.0	K20TT	IK20TT	IK20TT	5
2.0 20V (838AG1AA, 838AG11A)	114	838 A6.000		07/96-10/01	K20TNR	3304	1.0	K20TT	IK20TT	IK20TT	5
2.0 20V (838BG1AA)	114	838 A6.000		07/96-10/01	K20TNR	3304	1.0	K20TT	IK20TT	IK20TT	5
2.0 20V Turbo (838AM1AA)	162	175 A3.000		06/98-10/01	PK20PR-P8	3245	0.8	-	IK20TT	IK20TT	5
2.0 20V Turbo (838BM1AA)	162	175 A3.000		06/98-10/01	PK20PR-P8	3245	0.8	-	IK20TT	IK20TT	5
2.0 20V Turbo (838CM)	162	175 A3.000		06/98-03/01	PK20PR-P8	3245	0.8	-	IK20TT	IK20TT	5
2.4 20V (838AC1AA, 838AC11A)	129	838 A2.000		08/94-10/01	K20TNR	3304	1.0	K20TT	IK20TT	IK20TT	5
2.4 20V (838BC1AA, 838BC11A)	129	838 A2.000		07/96-10/01	K20TNR	3304	1.0	K20TT	IK20TT	IK20TT	5
2.4 20V (838CC)	129	838 A2.000		11/96-03/01	K20TNR	3304	1.0	K20TT	IK20TT	IK20TT	5
2.4 JTD (838AL1AA)	100	838 A8.000		06/98-10/01	DG-122		11V				5
2.4 JTD (838BL1AA)	100	838 A8.000		06/98-10/01	DG-122		11V				5
2.4 T.DS (838AE1AA, 838AH1AA)	91	838 A3.000; 838 A7.000		08/94-10/01	DG-102		11V				5





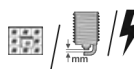

Spark & Glow Plugs







Application Tables







	KW					Standard			Twin Tip				QTY	
LANCIA <i>continued</i>														
KAPPA (94-01) <i>continued</i>														
2.4 T.DS (838BH1AA)	91	838 A3.000; 838 A7.000		07/96-10/01	DG-102		11V							5
3.0 24V (838AD1AA, 838AD11A, 838XD1AA, 838ZD1AA)	150	838 B.000		08/94-10/01	PK20PR-P8	3245	0.8	-		IK20TT	IK20TT			6
3.0 24V (838BD11A)	150	838 B.000		07/96-10/01	PK20PR-P8	3245	0.8	-		IK20TT	IK20TT			6
3.0 24V (838CD, 838CD11A)	150	838 B.000		11/96-03/01	PK20PR-P8	3245	0.8	-		IK20TT	IK20TT			6
LYBRA (99-05)														
1.6	76	182B6.000		10/00-10/05	K16PR-U	3191	0.8		K16TT	IK16TT	IK16TT			4
1.6 16V (839AXA1A)	76	182 A4.000		07/99-10/05	K16PR-U	3191	0.8		K16TT	IK16TT	IK16TT			4
1.6 16V (839BXA1A)	76	182 A4.000		07/99-10/05	K16PR-U	3191	0.8		K16TT	IK16TT	IK16TT			4
1.8 16V (839AXB1A, 839AXG1A)	96	839 A9.000		07/99-10/05	K20TNR	3304	1.0		K20TT	IK20TT	IK20TT			4
1.8 16V (839BXB1A, 839BXG1A)	96	839 A7.000		07/99-10/05	K20TNR	3304	1.0		K20TT	IK20TT	IK20TT			4
1.9 JTD	85	937 A2.000		05/01-10/05	DG-122		11V							4
1.9 JTD (839AXD1A)	77	AR 32302		07/99-09/00	DG-122		11V							4
1.9 JTD (839AX1A)	81	AR 37101		09/00-05/01	DG-122		11V							4
1.9 JTD (839BXD1A)	77	AR 32302		07/99-09/00	DG-122		11V							4
1.9 JTD (839BX1A)	81	AR 37101		09/00-05/01	DG-122		11V							4
2.0 20V (839AXC11, 839AXC1A)	113	182 B7.000		07/99-09/00	K20TNR	3304	1.0		K20TT	IK20TT	IK20TT			5
2.0 20V (839AXH1A)	110	185 A8.000		09/00-10/05	K20TNR	3304	1.0		K20TT	IK20TT	IK20TT			5
2.0 20V (839BXC11, 839BXC1A)	113	182 B7.000		07/99-09/00	K20TNR	3304	1.0		K20TT	IK20TT	IK20TT			5
2.0 20V (839BXH1A)	110	185 A8.000		09/00-10/05	K20TNR	3304	1.0		K20TT	IK20TT	IK20TT			5
2.4 JTD	110	841 C.000		05/02-10/05	DG-122		11V							5
2.4 JTD (839AXE1A)	99	839 A5.000; AR 32501		07/99-02/01	DG-122		11V							5
2.4 JTD (839AXL1A)	103	839 A6.000		09/00-05/02	DG-122		11V							5
2.4 JTD (839BXE1A)	99	839 A5.000; AR 32501		10/99-09/00	DG-122		11V							5
2.4 JTD (839BXL1A)	103	839 A6.000		09/00-10/05	DG-122		11V							5
MUSA (04-)														
1.3 D Multijet	51/66	188 A9.000; 199 A3.000		10/04-	DG-171		11V							4
1.3 D Multijet	70	199 B1.000		03/09-	DG-621		4.4V							4
1.4	57/66/70	192 B2.000; 350 A1.000; 843 A 1.000		10/04-	XU22EPR-U	3179	0.9		XU22TT	-		VXU22		4
1.4 LPG	57	350 A1.000		11/10-	VXU22	5608	0.9		-	-		VXU22		4
1.6 D Multijet	85/88	350 A2.000; 350 A3.000		07/08-	DG-608		4.4V							4
1.9 D Multijet	74	188 B2.000		10/04-	DG-122		11V							4
PHEDRA (02-10)														
2.0 (179AXA11)	100	EW10J4(RFN)		09/02-11/10	K20HR-U11	3381	1.1		KH20TT	IKH20TT	IKH20TT			4
2.0 D Multijet	100	RHR (DW10BTED4)	Ch: >C6991	07/06-11/10	DG-116		11V							4
2.0 D Multijet	100	RHR (DW10BTED4)	Ch: D6991>	07/06-11/10	DG-181		11V							4
2.0 JTD	79	RHM (DW10ATED4)		07/03-11/10	DG-116		11V							4
2.0 JTD	88	RHK (DW10UTED4)	Ch: >C6991	06/06-11/10	DG-116		11V							4
2.0 JTD	88	RHK (DW10UTED4)	Ch: D6991>	06/06-11/10	DG-181		11V							4
2.0 JTD (179AXB1A)	80	RHW (DW10ATED4)		09/02-11/10	DG-116		11V							4
2.2 D Multijet	125	4HS; 4HT		03/08-11/10	DG-614		11V							4
2.2 JTD	120	4HP; 4HR		04/06-11/10	DG-614		11V							4
2.2 JTD (179AXC1A)	94	4HW(DW12ATED4)	OE: 9652548280	09/02-11/10	DG-181		11V							4
2.2 JTD (179AXC1A)	94	4HW(DW12ATED4)	Ch: >C6991, OE: 9651029780;9638985980;9623638380	09/02-02/04	DG-116		11V							4
3.0 V6	150	ES9 J4S		09/02-11/10	VKH16	5617	1.1			IKH16TT	IKH16TT			6
PRISMA (83-92)														
1.3	58	831 A2.000		01/83-02/92	W22EPR-U	3088	0.8		W22TT	-		VW22		4
1.5	59	831 B1.000		08/86-02/92	W22EPR-U	3088	0.8		W22TT	-		VW22		4
1.6	73	831 B6.000		08/86-12/89	W22EPR-U	3088	0.8		W22TT	-		VW22		4
1.6 i.e.	80	831 B7.000		05/86-12/89	W22EPR-U	3088	0.8		W22TT	-		VW22		4
1.9 Diesel	48	831 D.000		01/83-02/92	DG-001		11V							4
1.9 Turbo Diesel	59	831 D1.000		05/85-12/89	DG-001		11V							4
2.0 i.e. All-wheel Drive	85	831 B4.000		04/86-12/89	W22EPR-U	3088	0.8		W22TT	-		VW22		4

	KW					Standard			Twin Tip				QTY	
LANCIA <i>continued</i>														
THEMA (84-94)														
8.32 (834F)	158	F 105 L		09/87-05/89	X24ESR-U	4101	0.7	-	-	-	-	-	-	8
8.32 (834FS)	151	F 105 L.046		10/87-05/92	XU27EPR-U	3313	0.9	-	-	-	-	-	-	8
2000 16V (834FA)	112	834 F1.000		05/92-07/94	W20EPR-U	3047	0.8	W20TT	IW20TT	IW20TT	-	-	-	4
2000 16V Turbo (834AC)	133	834 C1.000		12/88-06/90	W22EPR-U	3088	0.8	W22TT	-	-	-	VW22	-	4
2000 16V Turbo (834GC, 834FC)	148	834 F2.000		10/92-07/94	K22PBR-S	5062	0.85	-	-	-	-	VK22	-	4
2000 i.e (834AB)	86	834 B1.000		09/88-05/92	W22EPR-U	3088	0.8	W22TT	-	-	-	VW22	-	4
2000 i.e. (834B)	88	834 B.000		11/84-09/88	W20EPR-U	3047	0.8	W20TT	IW20TT	IW20TT	-	-	-	4
2000 i.e. (834BV)	85	834 B.146		09/87-05/92	W22EPR-U	3088	0.8	W22TT	-	-	-	VW22	-	4
2000 i.e. 16V (834AA)	108	834 B2.000		05/88-08/92	W20EPR-U	3047	0.8	W20TT	IW20TT	IW20TT	-	-	-	4
2000 i.e. 16V (834AI)	104	834 B2.246		02/89-05/92	W20EPR-U	3047	0.8	W20TT	IW20TT	IW20TT	-	-	-	4
2000 i.e. 16V Turbo (834AC)	133	834 C1.000		12/88-06/90	K22PBR-S	5062	0.85	-	-	-	-	VK22	-	4
2000 i.e. 16V Turbo (834AL)	130	834 C1.246		04/89-03/93	W20EPB	5065	0.85	W20TT	IW20TT	IW20TT	-	-	-	4
2000 i.e. Turbo (834C)	122	834 C.000		11/84-12/87	K22PBR-S	5062	0.85	-	-	-	-	VK22	-	4
2000 i.e. Turbo (834CV)	110	834 C.146		07/86-05/90	K22PBR-S	5062	0.85	-	-	-	-	VK22	-	4
2000 Turbo	110	834 C.146		01/89-03/92	K22PBR-S	5062	0.85	-	-	-	-	VK22	-	4
2000 Turbo 16V (834GC, 834FC)	148	834 F2.000		11/92-07/94	K22PBR-S	5062	0.85	-	-	-	-	VK22	-	4
2500 Turbo D (834D)	74	8144.91		11/84-09/88	DG-001		11V							4
2500 Turbo DS (834AE)	85	8144.97		06/88-05/92	DG-001		11V							4
2500 Turbo DS (834AM)	77	8144.97S		05/88-07/92	DG-001		11V							4
2500 Turbo DS (834D)	74	8144.91		03/87-09/90	DG-001		11V							4
2500 Turbo DS (834FE, 834LE)	85	8144.97 Y		05/92-07/94	DG-001		11V							4
3000 V6 (834GD, 834FD)	126	834 F.000		08/92-07/94	W20EPR-U	3047	0.8	W20TT	IW20TT	IW20TT	-	-	-	6
THEMA (11-)														
3.6	210	ERB		09/11-	ITV20	5339	1.1	-	ITV20TT	ITV20TT	-	-	-	6
3.6 4WD	210	ERB		09/11-	ITV20	5339	1.1	-	ITV20TT	ITV20TT	-	-	-	6
THESIS (02-09)														
2.0 Turbo (841AXA1B03)	136	841 E.000		07/02-07/09	K20PBR-S10	5061	1.0	K20TT	IK20TT	IK20TT	-	-	-	5
2.4 (841AXB1B00)	125	841D.000		07/02-01/05	K20TNR	3304	1.0	K20TT	IK20TT	IK20TT	-	-	-	5
2.4 D Multijet	136	841 P.000		04/06-07/09	DG-170		11V							5
2.4 JTD	129	841 G.000		05/03-07/09	DG-170		11V							5
2.4 JTD (841AXD1B02)	110	841 C.000		07/02-07/09	DG-122		11V							5
3.0 V6 (841AXC1101)	158	841A.000		07/02-03/05	PK20PR-P8	3245	0.8	-	IK20TT	IK20TT	-	-	-	6
TREVI (80-87)														
2000 i.e.	90	828B1.000		07/81-01/85	W20EPR-U	3047	0.8	W20TT	IW20TT	IW20TT	-	-	-	4
2000 Volumex (828DB17)	99	828B7.000		08/83-05/85	W20EPR-U	3047	0.8	W20TT	IW20TT	IW20TT	-	-	-	4
VOYAGER (11-)														
3.6 V6 VVT	208	ERB		09/11-	ITV20	5339	1.1	-	ITV20TT	ITV20TT	-	-	-	6
Y (95-03)														
1.1 (840AE)	40	176 B2.000		04/97-09/03	K20PR-U	3145	0.8	K20TT	IK20TT	IK20TT	-	-	-	4
1.2 (840AA, 840AF1A)	44	188A4.000		09/00-09/03	K16PR-U	3191	0.8	K16TT	IK16TT	IK16TT	-	-	-	4
1.2 (840AA, 840AF1A)	44	840 A3.000		03/96-10/99	Q20PR-U	3007	0.8	Q20TT	IQ20TT	IQ20TT	-	-	-	4
1.2 16V (840AD)	63	176 B9.000		04/97-07/00	XU24EPR-U	3312	0.9	-	-	-	-	VXU24	-	4
1.2 16V (840AG1A)	59	188A5.000		10/00-09/03	XU24EPR-U	3312	0.9	-	-	-	-	VXU24	-	4
1.4 12V (840AB)	59	840 A2.000		10/96-09/03	K20TNR	3304	1.0	K20TT	IK20TT	IK20TT	-	-	-	4
1.4 12V (840AC)	55	840 A4.000		03/96-09/03	K20TNR	3304	1.0	K20TT	IK20TT	IK20TT	-	-	-	4
Y10 (85-95)														
1.0 Fire	37	156 A 2.000		03/85-02/90	Q20PR-U	3007	0.8	Q20TT	IQ20TT	IQ20TT	-	-	-	4
1.0 Fire (156AA)	33	156 A 2.000		03/85-06/89	Q20PR-U	3007	0.8	Q20TT	IQ20TT	IQ20TT	-	-	-	4
1.0 Fire (156AE) CAT	33	156 A2.246		10/87-06/89	Q20PR-U	3007	0.8	Q20TT	IQ20TT	IQ20TT	-	-	-	4
1.0 Fire (156B, 156AD)	32	156 A2.100		06/85-06/91	Q20PR-U	3007	0.8	Q20TT	IQ20TT	IQ20TT	-	-	-	4
1.0 Fire All-wheel Drive	37	156 A 2.000		12/87-02/90	Q20PR-U	3007	0.8	Q20TT	IQ20TT	IQ20TT	-	-	-	4
1.0 Fire All-wheel Drive (156AE)	33	156 A2.246		12/87-02/92	Q20PR-U	3007	0.8	Q20TT	IQ20TT	IQ20TT	-	-	-	4
1.1 Avenue (156AG)	40	176 B2.000		01/95-12/95	Q20PR-U	3007	0.8	Q20TT	IQ20TT	IQ20TT	-	-	-	4
1.1 Avenue All-wheel Drive (156AG)	40	176B2.000		01/95-12/95	K16PR-U	3191	0.8	K16TT	IK16TT	IK16TT	-	-	-	4
1.1 i.e (156AC)	42	156 C.000		08/89-06/92	Q20PR-U	3007	0.8	Q20TT	IQ20TT	IQ20TT	-	-	-	4
1.1 i.e All-wheel Drive (156AC)	42	156 C.000		08/89-06/92	Q20PR-U	3007	0.8	Q20TT	IQ20TT	IQ20TT	-	-	-	4
1.1 i.e. Fire (156AG)	37	156 C.046		07/89-09/95	Q20PR-U	3007	0.8	Q20TT	IQ20TT	IQ20TT	-	-	-	4
1.1 i.e. Fire All-wheel Drive (156AG)	37	156 C.046		09/92-12/95	Q20PR-U	3007	0.8	Q20TT	IQ20TT	IQ20TT	-	-	-	4
1.3 i.e. Fire (156AB)	56	156 B.000		11/87-05/93	W20EPR-U	3047	0.8	W20TT	IW20TT	IW20TT	-	-	-	4
1.3 i.e. Fire (156AF)	53	146 A 5.046		02/89-12/95	W20EPR-U	3047	0.8	W20TT	IW20TT	IW20TT	-	-	-	4

	KW								QTY	
LANCIA continued										
YPSILON (843) (03-11)										
1.2	59	188 A4.000		10/03-12/11	K16PR-U	3191 0.8	K16TT	IK16TT	IK16TT	4
1.2	51	169 A4.000		08/10-12/11	XU22EPR-U	3179 0.9	XU22TT	-	VXU22	4
1.2	44	188 A4.000	Eng: >2533528	10/03-09/04	K16PR-U	3191 0.8	K16TT	IK16TT	IK16TT	4
1.2	44	188 A4.000	Eng: 2533529>	10/04-12/11	XU22EPR-U	3179 0.9	XU22TT	-	VXU22	4
1.3 D Multijet	55/66/77	199 A2.000; 199 A3.000		09/06-12/11	DG-171		11V			4
1.3 JTD	51	188 A9.000		10/03-12/11	DG-171		11V			4
1.4	57	350 A1.000		02/06-12/11	XU22EPR-U	3179 0.9	XU22TT	-	VXU22	4
1.4 16V	70	843 A 1.000		10/03-12/11	XU22EPR-U	3179 0.9	XU22TT	-	VXU22	4
1.4 LPG	57	350 A1.000		11/10-12/11	VXU22	5608 0.9	-	-	VXU22	4
YPSILON (846) (11-)										
1.2	51	169 A4.000		05/11-	XU22EPR-U	3179 0.9	XU22TT	-	VXU22	4
1.2 Bifuel	49	169 A4.000		05/11-	XU22EPR-U	3179 0.9	XU22TT	-	VXU22	4
1.3 Multijet	70	199 B1.000		05/11-	DG-621		4.4V			4
ZETA (95-02)										
2.0 16V (220AL5)	97	RFV		05/98-07/00	K20PR-U	3145 0.8	K20TT	IK20TT	IK20TT	4
2.0 16V (220AQ5)	100	EW10J4(RFN)		07/00-09/02	K20HR-U11	3381 1.1	KH20TT	IKH20TT	IKH20TT	4
2.0 JTD	80	RHZ (DW10ATED)		04/00-09/02	DG-116		11V			4
2.0 JTD (220AN5)	80	RHW (DW10ATED4)		09/99-09/02	DG-116		11V			4
2.0 Turbo (220AD5, 220CD5)	108	RGX		05/95-09/02	K20TXR	5063 1.0	K20TT	IK20TT	IK20TT	4
2.1 TD (220AJ5)	80	P 8 C		05/96-09/99	DG-001		11V			4
LAND ROVER										
88 / 109 (61-86)										
2.3 4x4	57	11H		10/71-12/71	W20ESR-U	3057 0.8	-	-	-	4
2.3 4x4 (LR 88 OL, LR 109 OL)	51	11;11H		10/71-10/83	W20ESR-U	3057 0.8	-	-	-	4
2.3 4x4 (LR 88 OP, LR 109 OP)	51	11H		10/71-10/83	W20ESR-U	3057 0.8	-	-	-	4
2.3 4x4 (LR 88 OP, LR 109 OP)	51	11G	LPG / GPL	11/79-10/83	W20ESR-U	3057 0.8	-	-	-	4
2.3 D 4x4 (LR 88 DL, LR 109 DL)	46	10 J; 23 J	Eng: 10J01175>	09/83-12/86	DG-001		11V			4
2.3 D 4x4 (LR 88 DL, LR 109 DL)	46	10 J; 23 J	Eng: 36623972B>	09/71-08/83	DG-001		11V			4
2.3 D 4x4 (LR 88 DP, LR 109 DP)	46	10 J; 23 J	Eng: 10J01175>	09/83-12/86	DG-001		11V			4
2.3 D 4x4 (LR 88 DP, LR 109 DP)	46	10 J; 23 J	Eng: 36623972B>	09/71-08/83	DG-001		11V			4
3.5 4x4	68			01/80-12/83	W16EPR-U	3021 0.8	W16TT	IW16TT	IW16TT	8
90 / 110 (83-90)										
2.3 4x4	52	10 H		01/84-08/87	W16ESR-U	3110 0.8	-	-	-	4
2.5 4x4	61/62	17 H		09/85-07/90	W16EPR-U	3021 0.8	W16TT	IW16TT	IW16TT	4
2.5 D 4x4	51	12 J		09/83-07/90	DG-001		11V			4
2.5 TD 4x4	63	19 J		09/86-07/90	DG-001		11V			4
DEFENDER (90-)										
2.4 Td4 4x4	90	244DT		05/07-	DG-130		11.5V			4
2.5 4x4	61	17H		09/90-12/94	W20EX-U	3062 0.8	W20TT	IW20TT	IW20TT	4
2.5 90 TDI 4x4	83	11 L; 16 L; 23 L		09/90-12/98	DG-115		11.5V			4
2.5 90,110 TDI 4x4	83	11 L; 16 L; 23 L		09/90-12/98	DG-115		11.5V			4
2.5 D 4x4	51	12 J		09/90-02/94	DG-001		11V			4
2.5 Td5 4x4	90	10 P; 14 P; 15 P		06/98-11/07	DG-182		11V			5
3.5 4x4	86	11 D		09/90-08/93	W16EPR-U	3021 0.8	W16TT	IW16TT	IW16TT	8
3.5 4x4	100	20G		09/90-02/94	W16EXR-U	3031 0.8	W16TT	IW16TT	IW16TT	8
3.9 V8 4x4	136	36D		11/98-05/00	W16EXR-U	3031 0.8	W16TT	IW16TT	IW16TT	8
DISCOVERY I (89-98)										
2.0 16 V 4x4	99			09/93-10/98	K20PR-U	3145 0.8	K20TT	IK20TT	IK20TT	4
2.5 D 4x4	90	19L		01/96-10/98	DG-115		11.5V			4
2.5 TDI 4x4	83	12 L; 17 L; 19 L; 21 L		10/89-10/98	DG-115		11.5V			4
3.5 4x4	98/122	22 D		10/89-06/94	W20EPR-U	3047 0.8	W20TT	IW20TT	IW20TT	8
3.5 4x4 (SALLJG)	113	22 D		10/89-06/94	W20EPR-U	3047 0.8	W20TT	IW20TT	IW20TT	8
3.9 V8 4x4	134/136	35 D; 36 D; 37 L		09/93-10/98	W20EPR-U	3047 0.8	W20TT	IW20TT	IW20TT	8
DISCOVERY II (98-04)										
2.5 Td5 4x4	102	10 P; 15 P		01/99-06/04	DG-182		11V			5
2.5 TDI	83/90	12 L; 17 L; 19 L; 21 L; 22 L		10/95-	DG-115		11.5V			4
4.0 V8 4x4	136	56 D		11/98-06/04	PK16PR-L11	3275 1.1	-	IK16TT	IK16TT	8







	KW					Standard		Twin Tip		QTY
LAND ROVER <i>continued</i>										
DISCOVERY III (04-09)										
2.7 TD 4x4	140	276DT		07/04-09/09	DG-140		11V			6
4.0 4x4	161			02/05-09/09	PT16EPR-L13	5070	1.3	-	IT16TT	IT16TT
4.4 4x4	220	448PN		07/04-09/09	IK16	5303	1.1	-	IK16TT	IK16TT
DISCOVERY IV (09-)										
2.7 TD 4x4	140	276DT		09/09-	DG-140		11V			6
3.0 4x4	250			08/13-	IK24	5311	0.8	-	-	6
5.0 V8 4x4	276	508PN		09/09-	PK20PR-L11	3142	1.1	-	IK20TT	IK20TT
FREELANDER I (98-06)										
1.8 16V 4x4	86	18 K4F		11/00-10/06	PK20PR-L11	3142	1.1	-	IK20TT	IK20TT
1.8 i 16V 4x4	88	18 K4F		02/98-10/06	PK20PR-L11	3142	1.1	-	IK20TT	IK20TT
2.0 DI 4x4	72	20 T2N		02/98-10/06	DG-101		11V			4
2.0 Td4 4x4	80/82	204D3; M 47		11/00-10/06	DG-145		11V			4
2.5 V6 4x4	130	25 K4F		11/00-10/06	PK20PR-L11	3142	1.1	-	IK20TT	IK20TT
FREELANDER II (06-14)										
2.0 Si4 4x4	177	204PT	40000km Lifetime	10/11-10/14	ITV22	5340	0.8	-	-	4
2.2 eD4	110	224DT; DW12BTED4	Ch: >AH999999	08/10-10/14	DG-614		11V			4
2.2 SD4 4x4	140	224DT	Ch: >AH999999	08/10-10/14	DG-614		11V			4
2.2 TD4 4x4	110/112/115/118	224DT; DW12BTED4	Ch: >AH999999	10/06-10/14	DG-614		11V			4
3.2 4x4	171	B 6324 S		10/06-10/14	VKH20Y	5639	0.8	-	-	6
RANGE ROVER Evoque (11-)										
2.0 4x4	177	204PT	40000km Lifetime	06/11-	ITV22	5340	0.8	-	-	4
RANGE ROVER I (70-94)										
2.4 TD 4x4	78/83	11 A		04/86-12/90	DG-202		11V			4
2.5 TD 4x4	89			10/89-10/92	DG-202		11V			4
3.5 4x4	96			10/85-08/91	W16EPR-U	3021	0.8	W16TT	IW16TT	8
3.5 4x4	107	31 D		01/87-09/90	W20EPR-U	3047	0.8	W20TT	IW20TT	8
3.5 4x4	97	11 D	Eng: >12/1975	07/70-08/81	W16FPR-U	4192	0.7	-	-	8
3.5 4x4	97	11 D	Eng: 01/1976>	07/70-08/81	W16EPR-U	3021	0.8	W16TT	IW16TT	8
3.5 Vogue 4x4	93	11 D		08/81-09/90	W16EPR-U	3021	0.8	W16TT	IW16TT	8
3.5 Vogue 4x4	120	24 D; 25 D		10/85-09/90	W20EX-U	3062	0.8	W20TT	IW20TT	8
3.9 4x4 CAT	127	37 D; 38 D		11/88-07/94	W20EX-U	3062	0.8	W20TT	IW20TT	8
3.9 Vogue SEI 4x4	134	35 D; 36 D		11/88-07/94	W20EX-U	3062	0.8	W20TT	IW20TT	8
4.3 Vogue LSE 4x4	149	40D		09/92-07/94	W16EXR-U	3031	0.8	W16TT	IW16TT	8
RANGE ROVER II (94-02)										
2.5 D 4x4	83	19 L; 22 L		08/94-03/02	DG-001		11V			4
2.5 TD 4x4	100	25 6T (BMW)		07/94-03/02	DG-001		11V			6
3.9 4x4	140	42D(190)		01/99-03/02	PK16PR-L11	3275	1.1	-	IK16TT	IK16TT
3.9 4x4	140	42D(190)		07/94-12/98	W16EXR-U	3031	0.8	W16TT	IW16TT	8
4.0 4x4	136	42D(185) - E97		06/98-03/02	PK16PR-L11	3275	1.1	-	IK16TT	IK16TT
4.0 4x4	136	42D(185) - E97		06/98-12/98	W16EXR-U	3031	0.8	W16TT	IW16TT	8
4.6 4x4	160/165	46D(218); 46D(224)		06/98-03/02	PK16PR-L11	3275	1.1	-	IK16TT	IK16TT
4.6 4x4	165	46D(224)		07/94-12/98	W16EXR-U	3031	0.8	W16TT	IW16TT	8
RANGE ROVER III (02-12)										
3.0 TD 6 4x4	130	306D1		03/02-08/12	DG-145		11V			6
3.6 TD 8 4x4	200	368DT		04/06-08/12	DG-140		11V			8
4.2 4x4	291	428PS		05/05-08/12	SK16R11	3324	1.1	-	IK16TT	IK16TT
4.4 4x4	210	M62 B44		03/02-08/12	K20TXR	5063	1.0	K20TT	IK20TT	8
4.4 4x4	225	448PN		05/05-08/12	SK16R11	3324	1.1	-	IK16TT	IK16TT
RANGE ROVER SPORT (05-)										
2.7 TDVM 4x4	140	276DT		02/05-	DG-140		11V			6
3.6 TD 8 4x4	200	368DT		04/06-	DG-140		11V			8
4.2 4x4	287	428PS		02/05-	SK16R11	3324	1.1	-	IK16TT	IK16TT
4.4 4x4	220	448PN		02/05-	SK16R11	3324	1.1	-	IK16TT	IK16TT
LANDWIND (JMC)										
LANDWIND (05-)										
2.4	92	4G64S4M		09/05-	K16PR-U11	3130	1.1	K16TT	IK16TT	4
2.8 D	68	JX493ZQ		09/05-	DG-108		11V			4
LDV										
400 (86-98)										
2.5 TD	71	ET 70		11/95-10/98	DG-001		11V			4







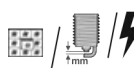



	KW				Standard 			Twin Tip 			QTY
LDV continued											
CONVOY (96-09)											
2.5 D	53/71	EN 55; ET 70		04/96-06/05	DG-001		11V				4
2.5 DI	56	EN 55;4HB; EN 55		10/98-12/06	DG-001		11V				4
2.5 TDI	74	ET 70		10/98-10/06	DG-001		11V				4
CUB (98-01)											
2.3 D	53	LD23		08/98-09/01	DG-137		11V				4
MAXUS (05-09)											
2.5 D	70/ 88/ 99	VM39C; VM40C		02/05-12/09	DG-176		11.5V				4
PILOT (96-05)											
1.9 D	52	XUD9		04/96-10/05	DG-001		11V				4
SHERPA (74-89)											
1.7	54	KB17		10/78-12/82	T20EPR-U	5032	0.8	T20TT	IT20TT	IT20TT	4
3.5	103			01/83-09/88	W16EPR-U	3021	0.8	W16TT	IW16TT	IW16TT	6
LEXUS											
CT (10-)											
200h	73	2ZR-FXE; 5ZR-FXE		12/10-	SC20HR11	3444	1.1	-	IXEH22TT	IXEH22TT	4
ES (89-97)											
300	138	3VZ-FE		09/91-12/97	PQ20R	3117	1.1	Q20TT	IQ20TT	IQ20TT	6
ES (06-12)											
3.5	204	2GR-FE		05/06-06/12	FK20HR11	3426	1.1	-	IKH20TT	IKH20TT	6
ES (12-)											
250	135	2AR-FE		06/12-	SK16HR11	3417	1.1	-	IKH16TT	IKH16TT	4
350	204	2GR-FE		06/12-	FK20HR11	3426	1.1	-	IKH20TT	IKH20TT	6
GS (93-97)											
300	156	2JZ-GE-221		01/95-08/97	PK20R11	3128	1.1	K20TT	IK20TT	IK20TT	6
GS (97-05)											
300	161	2JZ-GE		10/00-03/05	SK20R-P11	3335	1.1	-	IK20TT	IK20TT	6
300 T3	163	2JZ-GE		08/97-10/00	PK20TR11	3253	1.1	K20TT	IK20TT	IK20TT	6
400	216	1UZ-FE		12/97-11/00	SK20R11	3297	1.1	-	IK20TT	IK20TT	8
430	208	3UZ-FE		11/00-03/05	SK20R11	3297	1.1	-	IK20TT	IK20TT	8
GS (05-11)											
3.0	170	3GR-FE		05/05-11/11	FK20HR11	3426	1.1	-	IKH20TT	IKH20TT	6
3.0	170	3GR-FE		04/05-05/05	SK20HR11	3421	1.1	-	IKH20TT	IKH20TT	6
300	183	3GR-FSE		04/05-09/07	FK20HBR11	3473	1.1	-	IKBH20TT	IKBH20TT	6
300	183	3GR-FSE		09/07-11/11	FK20HR11	3426	1.1	-	IKH20TT	IKH20TT	6
350	226/ 232	2GR-FSE		04/08-11/11	FK20HBR11	3473	1.1	-	IKBH20TT	IKBH20TT	6
350 AWD	226/ 232	2GR-FSE		04/08-11/11	FK20HBR11	3473	1.1	-	IKBH20TT	IKBH20TT	6
430	208	3UZ-FE		04/05-09/08	SK20R11	3297	1.1	-	IK20TT	IK20TT	8
450h (GWS191)	218/ 254	2GR-FSE		02/06-11/11	FK20HBR11	3473	1.1	-	IKBH20TT	IKBH20TT	6
460	255	1UR-FSE		05/08-11/11	FK20HBR11	3473	1.1	-	IKBH20TT	IKBH20TT	8
GS (12-)											
250	154/ 158	4GR-FSE		01/12-	FK20HBR11	3473	1.1	-	IKBH20TT	IKBH20TT	6
350	234	2GR-FSE		01/12-	FK20HBR11	3473	1.1	-	IKBH20TT	IKBH20TT	6
350 AWD	234	2GR-FSE		01/12-	FK20HBR11	3473	1.1	-	IKBH20TT	IKBH20TT	6
GX (01-09)											
470	175/ 199	2UZ-FE		11/01-11/09	SK20R11	3297	1.1	-	IK20TT	IK20TT	8
GX (09-)											
470	218	1UR-FE		11/09-	SK16HR11	3417	1.1	-	IKH16TT	IKH16TT	8
IS C (09-)											
250	153	4GRFSE(208)		04/09-	FK20HBR11	3473	1.1	-	IKBH20TT	IKBH20TT	6
300	170	3GR-FE		11/10-	FK20HR11	3426	1.1	-	IKH20TT	IKH20TT	6
350	228/ 234	2GR-FSE		04/09-	FK20HBR11	3473	1.1	-	IKBH20TT	IKBH20TT	6
IS I (99-05)											
200	114	1G-FE		04/99-10/05	SK20R11	3297	1.1	-	IK20TT	IK20TT	6
300	157	2JZ-GE		09/01-10/05	SK20R-P11	3335	1.1	-	IK20TT	IK20TT	6
IS II (05-)											
200d	110	2AD-FTV		07/10-	DG-600		11V				4
220d (ALE20)	130	2AD-FHV		10/05-	DG-600		11V				4
250	158	4GR-FSE		11/10-	FK20HBR11	3473	1.1	-	IKBH20TT	IKBH20TT	6
250 (GSE20)	153	4GR-FSE		10/05-	FK20HBR11	3473	1.1	-	IKBH20TT	IKBH20TT	6
250 AWD	153/ 158	4GR-FSE		10/05-	FK20HBR11	3473	1.1	-	IKBH20TT	IKBH20TT	6
350	228/ 234	2GR-FSE		10/05-	FK20HBR11	3473	1.1	-	IKBH20TT	IKBH20TT	6

	KW					Standard			Twin Tip			QTY
LEXUS <i>continued</i>												
IS II (05-) <i>continued</i>												
350 AWD	228	2GR-FSE		10/05-	FK20HR11	3473	1.1	-		IKBH20TT	IKBH20TT	6
IS F (USE20)	311	2UR-GSE		11/07-	FK20HR11	3473	1.1	-		IKBH20TT	IKBH20TT	8
IS III (13-)												
250	153	4GR-FSE		04/13-	FK20HR11	3473	1.1	-		IKBH20TT	IKBH20TT	6
LS (89-94)												
400	180	1UZ-FE		12/89-12/94	PK20R11	3128	1.1		K20TT	IK20TT	IK20TT	8
LS (94-00)												
400	194	1UZ-FE		12/94-08/97	PK20R11	3128	1.1		K20TT	IK20TT	IK20TT	8
400	203/ 209/ 216	1UZ-FE		10/97-10/00	SK20R11	3297	1.1	-		IK20TT	IK20TT	8
LS (00-06)												
430	207	3UZ-FE		10/00-08/06	SK20R11	3297	1.1	-		IK20TT	IK20TT	8
LS (06-)												
460	270/ 280/ 283/ 285	1UR-FSE		10/09-	FK20HR11	3473	1.1	-		IKBH20TT	IKBH20TT	8
460	255	1UR-FE		05/08-	SK20HR11	3421	1.1	-		IKH20TT	IKH20TT	8
460 AWD	272/ 280/ 283	1UR-FSE		10/09-	FK20HR11	3473	1.1	-		IKBH20TT	IKBH20TT	8
460 AWD	270	1UR-FE		12/08-09/09	SK20HR11	3421	1.1	-		IKH20TT	IKH20TT	8
600h	290	2UR-FSE		08/07-11/09	FK20HR11	3473	1.1	-		IKBH20TT	IKBH20TT	8
LX (98-08)												
470	170/ 173/ 197	2UZ-FE		05/98-07/02	K20R-U	3122	0.8		K20TT	IK20TT	IK20TT	8
470	170/ 173/ 197/ 202	2UZ-FE		08/02-03/08	SK20R11	3297	1.1	-		IK20TT	IK20TT	8
LX (07-)												
570	270/ 282	3UR-FE		11/07-	SK20HR11	3421	1.1	-		IKH20TT	IKH20TT	8
RX (00-03)												
300	148	1MZ-FE		07/00-03/03	SK20R11	3297	1.1	-		IK20TT	IK20TT	6
300 AWD	148/ 164	1MZ-FE		07/00-05/03	SK20R11	3297	1.1	-		IK20TT	IK20TT	6
RX (03-08)												
3.3	171	3MZ-FE		04/03-01/06	SK20R11	3297	1.1	-		IK20TT	IK20TT	6
3.3 330 AWD	171	3MZ-FE		04/03-12/08	SK20R11	3297	1.1	-		IK20TT	IK20TT	6
300	150	1MZ-FE		05/03-01/06	SK20R11	3297	1.1	-		IK20TT	IK20TT	6
350	203	2GR-FE		01/06-12/08	FK20HR11	3426	1.1	-		IKH20TT	IKH20TT	6
350 AWD	203	2GR-FE		02/06-12/08	FK20HR11	3426	1.1	-		IKH20TT	IKH20TT	6
400h	155	3MZ-FE		09/05-12/08	SK20R11	3297	1.1	-		IK20TT	IK20TT	6
400h AWD	155	3MZ-FE		09/04-12/08	SK20R11	3297	1.1	-		IK20TT	IK20TT	6
RX (08-)												
3.5 AWD	183	2GR-FXE		04/09-	FK20HR11	3426	1.1	-		IKH20TT	IKH20TT	6
270	138	1AR-FE		12/08-	SK16HR11	3417	1.1	-		IKH16TT	IKH16TT	4
350	202/ 206	2GR-FE		12/08-	FK20HR11	3426	1.1	-		IKH20TT	IKH20TT	6
350 AWD	204/ 206	2GR-FE		12/08-	FK20HR11	3426	1.1	-		IKH20TT	IKH20TT	6
350h	220	2GR-FXE		04/12-	FK20HR11	3426	1.1	-		IKH20TT	IKH20TT	6
350h AWD	220	2GR-FXE		04/12-	FK20HR11	3426	1.1	-		IKH20TT	IKH20TT	6
450h	183	2GR-FXE		12/08-	FK20HR11	3426	1.1	-		IKH20TT	IKH20TT	6
450h AWD	183/ 220	2GR-FXE		12/08-	FK20HR11	3426	1.1	-		IKH20TT	IKH20TT	6
SC (01-10)												
430	210	3UZ-FE		05/01-07/10	SK20R11	3297	1.1	-		IK20TT	IK20TT	8
LOTUS												
2 ELEVEN (07-11)												
1.8	142	2ZZ-GE	OEM Optional	04/07-07/11	SK20R11	3297	1.1	-		IK20TT	IK20TT	4
ECLAT (75-86)												
2.0	119	907		10/75-05/80	W22EPR-U	3088	0.8		W22TT	-	VW22	4
2.2	119	912		05/80-08/86	W20EPR-U	3047	0.8		W20TT	IW20TT	IW20TT	4
ELAN (89-95)												
1.6 i 16V	97	4XE1		09/89-11/95	K20PR-U	3145	0.8		K20TT	IK20TT	IK20TT	4
1.6 i 16V Turbo	115/ 123	4XE1-T		09/89-11/95	K20PR-U	3145	0.8		K20TT	IK20TT	IK20TT	4
ELISE 340R (00-01)												
1.8	132			03/00-02/01	PK20PR-L11	3142	1.1	-		IK20TT	IK20TT	4

Spark & Glow Plugs

Application Tables







	KW								QTY		
LOTUS <i>continued</i>											
ELISE (95-01)											
1.8	88	18 K4F		08/95-11/00	PK20PR-L11	3142	1.1	-	IK20TT	IK20TT	4
ELISE (00-)											
1.6	100	1ZR-FAE		06/07-	SC20HR11	3444	1.1	-	IXEH22TT	IXEH22TT	4
1.8	99	1ZZ-FE		10/03-	K20R-U11	3139	1.1	K20TT	IK20TT	IK20TT	4
1.8	162	2ZR-FE		06/07-	SK20R11	3297	1.1	-	IK20TT	IK20TT	4
1.8	140/ 141	2ZZ-GE	OEM Optional	11/02-	SK20R11	3297	1.1	-	IK20TT	IK20TT	4
ELITE (74-82)											
2.0	119	907		05/74-05/80	W22EPR-U	3088	0.8	W22TT	-	VW22	4
2.2	119	912		05/80-12/82	W20EPR-U	3047	0.8	W20TT	IW20TT	IW20TT	4
ESPRIT S2 (75-88)											
2.0	119	907		10/75-05/80	W20EPR-U	3047	0.8	W20TT	IW20TT	IW20TT	4
2.2 Turbo	157	910		02/80-08/88	IW22	5307	0.8	-	-	VW22	4
ESPRIT S3 (80-88)											
2.2	119	912		05/80-08/86	W20EPR-U	3047	0.8	W20TT	IW20TT	IW20TT	4
ESPRIT S4 (89-03)											
2.2	222			11/94-07/96	W20ETR-L	3277	1.0	-	IW20TT	IW20TT	4
2.2 16V Turbo SE	197	910 S		05/89-09/96	W20ETR-L	3277	1.0	-	IW20TT	IW20TT	4
3.5 V8 32V Turbo	260	618		02/96-06/03	K20TNR-S9	3305	0.9	K20TT	IK20TT	IK20TT	8
EUROPA S (06-)											
2.0 Turbo	147	Z 20 LER		07/06-	KJ16CR-L11	3132	1.1	K16TT	IK16TT	IK16TT	4
2.0 Turbo	165	Z 20 LER		09/08-	KJ20CR-L11	3169	1.1	K20TT	IK20TT	IK20TT	4
EVORA (09-)											
3.5	206	2GR-FE		05/09-	FK20HR11	3426	1.1	-	IKH20TT	IKH20TT	6
3.5 S	257	2GR-FE		12/10-	VKH22	5619	0.8	-	-	VKH22	6
EXCEL (83-91)											
2.2	119	912		10/83-08/86	W20EPR-U	3047	0.8	W20TT	IW20TT	IW20TT	4
2.2 SE/SA	135	912 S		10/84-08/91	W20ETR-L	3277	1.0	-	IW20TT	IW20TT	4
EXIGE (00-12)											
1.8 16V	132/ 141/ 163	2ZZ-GE		05/00-06/12	SK20R11	3297	1.1	-	IK20TT	IK20TT	4
1.8 265 E	197	2ZZ-GE		08/06-06/12	PK22PR8	3273	0.8	-	-	VK22	4
1.8 Cup 240	181	2ZZ-GE		04/06-06/12	PK22PR8	3273	0.8	-	-	VK22	4
1.8 Cup 260	191	2ZZ-GE		04/06-06/12	PK22PR8	3273	0.8	-	-	VK22	4
1.8 GT3	202	2ZZ-GE		08/06-06/12	PK22PR8	3273	0.8	-	-	VK22	4
1.8 S	177	2ZZ-GE		01/08-04/11	PK22PR8	3273	0.8	-	-	VK22	4
EXIGE (12-)											
3.5 S	257	2GR-FE		06/12-	FK20HR11	3426	1.1	-	IKH20TT	IKH20TT	6
LTI											
TX (97-)											
2.4 i	112	4G69		04/09-	IKH20	5344	1.1	-	IKH20TT	IKH20TT	4
2.4 TDi	66			10/02-	DG-130		11.5V				4
2.5 TD	75	R 425 DOHC		01/06-	DG-176		11.5V				4
2.7 TD	60	TD27		01/97-	DG-198		11V				4
MAHINDRA											
CJ 3 (88-92)											
2.1 D	46	XDP 290		10/88-09/92	DG-001		11V				4
2.1 D All-wheel Drive	46	XDP 290		10/88-09/92	DG-001		11V				4
CJ5 (87-)											
2.1 D 4x4	44			10/87-	DG-001		11V				4
MARUTI											
800 (91-06)											
0.8	26	SUZUKI-FI		10/93-12/06	W16EPR-U	3021	0.8	W16TT	IW16TT	IW16TT	3
MASERATI											
228 (86-90)											
2.8	182	473		07/87-12/90	W24EPR-U	4136	0.8	-	-	-	6
420 / 430 (85-94)											
420	133	452..		03/85-12/86	IW22	5307	0.8	-	-	VW22	6
430 i	182	473		02/88-12/94	W24EPR-U	4136	0.8	-	-	-	6
3200 GT (98-02)											
3.2 Biturbo V8 32V	250/ 271			10/98-03/02	IU27	5363	0.9	-	-	-	8
BITURBO (81-94)											
2.0	136	452..		07/85-04/87	IW24	5316	0.7	-	-	-	6
2.24V	180	475		03/89-12/94	XU24EPR-U	3312	0.9	-	-	VXU24	6
2.5	147	453..		09/83-12/86	IW24	5316	0.7	-	-	-	6
2.8	165	473		01/89-12/94	IW22	5307	0.8	-	-	VW22	6
4.24V	180	475		04/90-12/94	XU27EPR-U	3313	0.9	-	-	-	6

	KW										QTY
MASERATI <i>continued</i>											
BITURBO (81-94) <i>continued</i>											
222	162	471..		01/89-10/89	W24EPR-U	4136	0.8	-	-	-	6
222 E	182	473		01/89-10/89	W24EPR-U	4136	0.8	-	-	-	6
222 SE	165	473		11/89-12/94	IW22	5307	0.8	-	-	VW22	6
425	140/ 147	453..		06/84-08/87	W24EPR-U	4136	0.8	-	-	-	6
425 i	138	453..		09/87-12/88	W24EPR-U	4136	0.8	-	-	-	6
S 2.0	151	454		12/81-02/87	W24EPR-U	4136	0.8	-	-	-	6
Si 2.0	151	471..		09/87-12/88	W24EPR-U	4136	0.8	-	-	-	6
BORA (71-80)											
4.7	228	107/47		01/71-05/80	IW20	5306	1.1	-	IW20TT	IW20TT	8
GHIBLI I (67-73)											
4.7	228			01/67-12/73	IW20	5306	1.1	-	IW20TT	IW20TT	8
GHIBLI II (92-)											
2.0 24V Biturbo	225	AM 496		05/92-	XU27EPR-U	3313	0.9	-	-	-	6
2.8 24V Biturbo	209	AM 574		06/92-	XU27EPR-U	3313	0.9	-	-	-	6
GRAN TURISMO (08-)											
4.2	295/ 298	M 139 P		08/08-	IU24	5362	0.9	-	-	-	8
GRANSPORT (03-)											
4.3	295	M 138 P		06/03-	IU24	5362	0.9	-	-	-	8
INDY (69-74)											
4.7	213			01/72-12/74	IW20	5306	1.1	-	IW20TT	IW20TT	8
KARIF (88-)											
3.2	225			04/90-06/00	IU27	5363	0.9	-	-	-	8
MC 12 (04-)											
6.0	465			08/04-	IU24	5362	0.9	-	-	-	12
MEXICO (67-72)											
4.7	213			01/67-12/72	IW20	5306	1.1	-	IW20TT	IW20TT	8
QUATTROPORTE III (79-90)											
4.7	188			06/79-10/85	IW20	5306	1.1	-	IW20TT	IW20TT	8
QUATTROPORTE IV (94-)											
2.0 Biturbo	211	24V DOHC		03/94-	XU27EPR-U	3313	0.9	-	-	-	6
2.8 Biturbo	209	AM 574; AM 574 A		03/94-	XU27EPR-U	3313	0.9	-	-	-	6
3.2 V8 32V	247	AM 578		12/95-	IU27	5363	0.9	-	-	-	8
QUATTROPORTE V (04-)											
4.2	295	M139 A		03/04-	IU24	5362	0.9	-	-	-	8
SHAMAL (89-95)											
3.2	240			12/89-11/95	XU24EPR-U	3312	0.9	-	-	VXU24	8
SPYDER Coupe (02-)											
4.2	287	M 138		03/02-	IU24	5362	0.9	-	-	-	8
4.2 Grand Sport	295	M 138 P		06/05-	IU24	5362	0.9	-	-	-	8
SPYDER GT (01-)											
4.2	287	M 138		10/01-	IU24	5362	0.9	-	-	-	8
MAYBACH											
MAYBACH (02-12)											
5.5 V12 57/62 (240.078, 240.178)	405	M 285.950		09/02-12/12	VK20	5604	1.1	-	IK20TT	IK20TT	12
6.0 Biturbo	471	M 285.980		06/09-12/12	VK20	5604	1.1	-	IK20TT	IK20TT	12
6.0 V12 57/62	463	M 285.980		01/11-12/12	VK20	5604	1.1	-	IK20TT	IK20TT	12
6.0 V12 57S (240.079)	450			09/05-12/12	VK20	5604	1.1	-	IK20TT	IK20TT	12
MAZDA											
2 (03-)											
1.2	55	FUJA		09/05-01/08	PT16VR13	5068	1.3	TV16TT	ITV16TT	ITV16TT	4
1.2	55	FUJA		02/03-08/05	SK16PR-E11	3412	1.1	-	IK16TT	IK16TT	4
1.25	55	FUJA		09/05-01/08	PT16VR13	5068	1.3	TV16TT	ITV16TT	ITV16TT	4
1.25	55	FUJA		04/03-08/05	SK16PR-E11	3412	1.1	-	IK16TT	IK16TT	4
1.4	59	FXJA		02/03-	T16VR-U10	5086	1.0	TV16TT	ITV16TT	ITV16TT	4
1.4 CD	50	F6JA; F6JB		04/03-08/05	DG-113		11V				4
1.4 CD	50	F6JA; F6JB		09/05-	DG-180		11V				4
1.6	74	FYJA		09/05-	PT16VR13	5068	1.3	TV16TT	ITV16TT	ITV16TT	4
1.6	74	DURA16		02/03-08/05	SK16PR-E11	3412	1.1	-	IK16TT	IK16TT	4
2 (07-)											
1.3	55/63	ZJ-VE		10/07-	VFK16		1.1	-	IK16TT	IK16TT	4
1.3 MZR	62	ZJ-VE		01/10-	VFK16		1.1	-	IK16TT	IK16TT	4
1.4 MZR-CD	50	Y404		01/08-	DG-180		11V				4
1.5	76	ZY-DE; ZY-VE		10/07-	VFK16		1.1	-	IK16TT	IK16TT	4
1.5 MZR	75	ZY05; ZY66		06/11-	VFK16		1.1	-	IK16TT	IK16TT	4
1.6 MZ-CD	66	Y406; Y646		10/08-	DG-180		11V				4

Spark & Glow Plugs









Application Tables











KW	KW	KW	NOTE	21	Standard			Twin Tip			QTY
					1mm	1mm	1mm	1mm	1mm	1mm	
MAZDA continued											
2 (07-) continued											
1.6 MZ-CD	70	Y655; Y661		06/11-	DG-603		5V				4
2 (14-)											
1.5	55/ 66/ 85	P5Y5; P5Y7; P5Y8		11/14-	VCH20	5637	1.1	-	IXEH22TT	IXEH22TT	4
3 (00-09)											
1.4	62	ZJ-VE		03/06-06/09	K16PR-U11	3130	1.1	K16TT	IK16TT	IK16TT	4
1.4	62	ZJ-VE		10/03-02/06	SK16PR-E11	3412	1.1	-	IK16TT	IK16TT	4
1.4	59	FXJA		02/04-06/09	T16VR-U10	5086	1.0	TV16TT	ITV16TT	ITV16TT	4
1.6	77	B6ZE; Z6		03/06-	K16PR-U11	3130	1.1	K16TT	IK16TT	IK16TT	4
1.6	77	B6ZE; Z6		10/03-02/06	SK16PR-E11	3412	1.1	-	IK16TT	IK16TT	4
1.6 DI Turbo	80	Y601		06/04-	DG-113		11V				4
2.0	110	LF17		03/06-12/08	ITV16	5338	1.1	-	ITV16TT	ITV16TT	4
2.0	104/ 110	LF17		04/04-12/08	ZT20EPR11	5087	1.1	T20TT	IT20TT	IT20TT	4
2.0 MZR-CD	105	RF7J		12/06-	DG-502		11V				4
2.3	118/ 126	L3-VE		06/00-03/09	ZT20EPR11	5087	1.1	T20TT	IT20TT	IT20TT	4
2.3 DiSi Turbo MPS	184	L3YH		06/06-06/09	ITV22	5340	0.8	-	-	-	4
2.3 MPS Turbo	191	L3N9; L3-VDT		12/06-06/09	ITV22	5340	0.8	-	-	-	4
2.3 MZR	115	L3-VE		03/05-03/09	ITV20	5339	1.1	-	ITV20TT	ITV20TT	4
2.3 MZR	115	L3-VE		03/04-02/05	ZT20EPR11	5087	1.1	T20TT	IT20TT	IT20TT	4
2.3 MZR Sport	126			03/05-06/09	ITV20	5339	1.1	-	ITV20TT	ITV20TT	4
2.3 MZR Sport	126			10/03-02/05	ZT20EPR11	5087	1.1	T20TT	IT20TT	IT20TT	4
3 (09-)											
1.6 MZR	77	MZR16		11/11-	K16PR-U11	3130	1.1	K16TT	IK16TT	IK16TT	4
1.6 MZR	77	MZR16(105)		06/09-	SK16PR-E11	3412	1.1	-	IK16TT	IK16TT	4
1.6 MZR	77	MZR16(105)	OEM Optional	06/09-	SK16PR-E11	3412	1.1	-	IK16TT	IK16TT	4
1.6 MZR CD	80/85	Y601; Y650; Y655		12/08-	DG-113		11V				4
1.6 MZR CD	80	Y642		12/08-07/11	DG-180		11V				4
2.0 MZR	110	LF17; LF-DE; MZR20(150)		06/09-12/10	ITV16	5338	1.1	-	ITV16TT	ITV16TT	4
2.0 MZR	108	LF5H		06/10-	ITV20	5339	1.1	-	ITV20TT	ITV20TT	4
2.0 MZR DISI	111	LF5H; LF5W		06/09-12/10	ITV16	5338	1.1	-	ITV16TT	ITV16TT	4
2.0 MZR DISI	111	LF5H; LF5W		01/11-	ITV20	5339	1.1	-	ITV20TT	ITV20TT	4
2.3 MPS Turbo	191	L3KG; L3-VDT		06/09-	ITV22	5340	0.8	-	-	-	4
3 (13-)											
1.5	74	P5Y1		09/13-	VCH20	5637	1.1	-	IXEH22TT	IXEH22TT	4
2.0	88/ 121	PEX2; PEY7		09/13-	VCH20	5637	1.1	-	IXEH22TT	IXEH22TT	4
5 (05-)											
1.8	85	MZR18(115)		03/05-	VT16	5621	1.1	-	IT16TT	IT16TT	4
2.0	107	LFF7		09/07-05/10	ITV16	5338	1.1	-	ITV16TT	ITV16TT	4
2.0	107	LFF7		06/10-	ITV20	5339	1.1	-	ITV20TT	ITV20TT	4
2.0	107	LFF7		03/05-08/07	VT16	5621	1.1	-	IT16TT	IT16TT	4
2.0 CD	81/ 105	RF7J		03/05-	DG-502		11V				4
2.3	122			03/05-	ITV20	5339	1.1	-	ITV20TT	ITV20TT	4
2.3	122			02/05-	ZT20EPR11	5087	1.1	T20TT	IT20TT	IT20TT	4
5 (10-)											
1.6 CD	85	Y650; Y655		09/10-	DG-603		5V				4
2.0	106/ 110	LF5H; LFZB		09/10-	ITV20	5339	1.1	-	ITV20TT	ITV20TT	4
6 (02-07)											
1.8	88	L813		03/05-08/07	VT16	5621	1.1	-	IT16TT	IT16TT	4
1.8	88	L813	Ch: >GG1* -242690	08/02-04/04	ZT20EPR11	5087	1.1	T20TT	IT20TT	IT20TT	4
1.8	88	L813	Ch: GG1* 242690->	04/04-03/05	T20EPR-U15	5033	1.5	T20TT	IT20TT	IT20TT	4
1.8	88	L813	Russia	03/05-08/07	T16EPR-U15	5023	1.5	T16TT	IT16TT	IT16TT	4
2.0	108	MZR20(147)		03/05-08/07	ITV16	5338	1.1	-	ITV16TT	ITV16TT	4
2.0	104	LF17; LF18	Ch: >GG1* -242690	06/02-04/04	ZT20EPR11	5087	1.1	T20TT	IT20TT	IT20TT	4
2.0	104	LF17; LF18	Ch: GG1* 242690->	04/04-03/05	T20EPR-U15	5033	1.5	T20TT	IT20TT	IT20TT	4
2.0	108	LFF7	Russia	03/05-08/07	T16VR-U10	5086	1.0	TV16TT	ITV16TT	ITV16TT	4
2.0 CITD 4x4	89/ 100	RF5C		10/02-02/05	DG-502		11V				4

	KW					Standard		Twin Tip		QTY	
MAZDA <i>continued</i>											
6 (02-07) <i>continued</i>											
2.0 DI	89/100/105	RF5C; RF7J		06/02-08/07	DG-502		11V			4	
2.3	120/122	MZR20(147)		03/05-08/07	ITV16	5338	1.1	-	ITV16TT	ITV16TT	4
2.3	122	L3C1	Ch: >GG1* -242690	06/02-04/04	ZT20EPR11	5087	1.1	T20TT	IT20TT	IT20TT	4
2.3	122	L3C1	Ch: GG1* 242690->	04/04-03/05	T20EPR-U15	5033	1.5	T20TT	IT20TT	IT20TT	4
2.3	120/122	L3C1	Russia	03/05-08/07	T16VR-U10	5086	1.0	TV16TT	ITV16TT	ITV16TT	4
2.3 AWD	119	MZR20(147)		03/05-08/07	ITV16	5338	1.1	-	ITV16TT	ITV16TT	4
2.3 AWD	119	L3C1	Ch: >GG1* -242690	11/02-04/04	ZT20EPR11	5087	1.1	T20TT	IT20TT	IT20TT	4
2.3 AWD	119	L3C1	Ch: GG1* 242690->	04/04-03/05	T20EPR-U15	5033	1.5	T20TT	IT20TT	IT20TT	4
2.3 AWD	119	L3C1	Russia	03/05-08/07	T16VR-U10	5086	1.0	TV16TT	ITV16TT	ITV16TT	4
2.3 MPS Turbo	191	L3KG		12/05-08/07	ITV22	5340	0.8	-	-	-	4
2.5	125	L5-VE		08/07-	ITV16	5338	1.1	-	ITV16TT	ITV16TT	4
2.5	125	L5-VE	Ch: Russia, > GH1* -501301	08/07-02/12	T16VR-U10	5086	1.0	TV16TT	ITV16TT	ITV16TT	4
3.0	162/164	AJ		01/04-12/07	IT20	5326	1.1	-	IT20TT	IT20TT	6
6 (07-)											
1.8 MZR	88	L813		08/07-	VT16	5621	1.1	-	IT16TT	IT16TT	4
1.8 MZR	88	L813	Ch: Russia, > GH1* -501301	08/07-02/12	T16EPR-U15	5023	1.5	T16TT	IT16TT	IT16TT	4
2.0 MZR	108	LF17		08/07-10/09	ITV16	5338	1.1	-	ITV16TT	ITV16TT	4
2.0 MZR	108/114	LF17; LF-DE		11/09-	ITV20	5339	1.1	-	ITV20TT	ITV20TT	4
2.0 MZR	108/114	LF17; LF-DE	Ch: Russia, > GH1* -501301	02/08-02/12	T16VR-U10	5086	1.0	TV16TT	ITV16TT	ITV16TT	4
2.0 MZR	108/114	LF17; LF-DE	Ch: Russia, GH1* 501301->	02/12-	ITV16	5338	1.1	-	ITV16TT	ITV16TT	4
2.5	125	L5-VE		02/08-	ITV16	5338	1.1	-	ITV16TT	ITV16TT	4
2.5	125	L5-VE	Ch: Russia, > GH1* -501301	02/08-02/12	T16VR-U10	5086	1.0	TV16TT	ITV16TT	ITV16TT	4
2.5 MZR	125	L5-VE		08/07-	ITV16	5338	1.1	-	ITV16TT	ITV16TT	4
2.5 MZR	125	L5-VE	Ch: Russia, > GH1* -501301	08/07-02/12	T16VR-U10	5086	1.0	TV16TT	ITV16TT	ITV16TT	4
6 (12-)											
2.0	107/114/121	PEY7		01/13-	VCH20	5637	1.1	-	IXEH22TT	IXEH22TT	4
2.5	138/141	PYY1		12/12-	VCH20	5637	1.1	-	IXEH22TT	IXEH22TT	4
121 I (87-90)											
1.1	42	B1		10/87-10/90	W16EPR-U11	3201	1.1	W16TT	IW16TT	IW16TT	4
1.3	40/44	B3		10/87-11/90	W16EPR-U	3021	0.8	W16TT	IW16TT	IW16TT	4
121 II (90-97)											
1.1	40	B1		11/90-10/93	W16EPR-U	3021	0.8	W16TT	IW16TT	IW16TT	4
1.3 16V	39	B3 (16V)		11/90-03/96	W16EPR-U	3021	0.8	W16TT	IW16TT	IW16TT	4
1.3 i 16V	53	B3 (16V)		11/90-03/96	K16PR-U11	3130	1.1	K16TT	IK16TT	IK16TT	4
121 III (96-03)											
1.25	55	DHF; DHG		03/96-04/03	PT16VR10	5093	1.0	TV16TT	ITV16TT	ITV16TT	4
1.3	37/44	J4R; J4T; JJK; JJM		03/96-04/03	PT16EPR-L13	5070	1.3	-	IT16TT	IT16TT	4
1.8 D	44	RTJ; RTK		03/96-04/03	DG-007		11.5V				4
323 C IV (89-00)											
1.3	49	B3E		09/89-07/94	W16EPR-U	3021	0.8	W16TT	IW16TT	IW16TT	4
1.3 16V	54	B3 (16V)		09/89-07/94	K16PR-U11	3130	1.1	K16TT	IK16TT	IK16TT	4
1.6	62	B6E		09/89-06/91	K16PR-U	3191	0.8	K16TT	IK16TT	IK16TT	4
1.6 16V	65	B6		03/91-10/94	W20EPR-U11	3049	1.1	W20TT	IW20TT	IW20TT	4
1.7 D	41	PN54		08/89-07/94	DG-311		11V				4
1.8 16V	103	BP31		09/89-03/93	K20PR-U	3145	0.8	K20TT	IK20TT	IK20TT	4
1.8 16V 4WD	76	BP		11/91-12/93	K20PR-U11	3121	1.1	K20TT	IK20TT	IK20TT	4
1.8 16V GT	94	BP (DOHC)		09/89-03/93	K16PR-U11	3130	1.1	K16TT	IK16TT	IK16TT	4
1.8 16V Turbo 4WD	120/136	BP Turbo		09/90-07/94	IK20	5304	1.1	-	IK20TT	IK20TT	4

Spark & Glow Plugs









Application Tables











	KW					Standard 			Twin Tip 			QTY
MAZDA <i>continued</i>												
323 C V (94-98)												
1.3 16V	54	B3 (16V)		08/94-09/98	K16PR-U11	3130	1.1	K16TT	IK16TT	IK16TT		4
1.5 16V	65	Z5-DE		08/94-09/98	K16PR-U11	3130	1.1	K16TT	IK16TT	IK16TT		4
1.8 16V	84	BP-ZE		08/94-09/98	K16PR-U11	3130	1.1	K16TT	IK16TT	IK16TT		4
323 F IV (87-94)												
1.6	62	B6E		09/89-06/91	K20PR-U11	3121	1.1	K20TT	IK20TT	IK20TT		4
1.6	77	B6 (SOHC)		04/87-08/93	W16EXR-U	3031	0.8	W16TT	IW16TT	IW16TT		4
1.6 16V	65	B6		03/91-10/94	K16PR-U	3191	0.8	K16TT	IK16TT	IK16TT		4
1.8 16V	103	BP31		09/89-03/93	K20PR-U	3145	0.8	K20TT	IK20TT	IK20TT		4
1.8 16V	76	BP		08/89-07/94	K20PR-U11	3121	1.1	K20TT	IK20TT	IK20TT		4
1.8 16V GT	94	BP (DOHC)		08/89-07/94	K20PR-U11	3121	1.1	K20TT	IK20TT	IK20TT		4
1.8 4WD	76	BPC		01/91-04/94	K20PR-U11	3121	1.1	K20TT	IK20TT	IK20TT		4
323 F V (94-98)												
1.5 16V	65	Z5-DE		07/94-09/98	K16PR-U11	3130	1.1	K16TT	IK16TT	IK16TT		4
1.8 16V	84	BP-ZE		08/94-09/98	K16PR-U11	3130	1.1	K16TT	IK16TT	IK16TT		4
2.0 24V	106	KF		08/94-09/98	K20PR-U11	3121	1.1	K20TT	IK20TT	IK20TT		6
323 F VI (98-04)												
1.4	53	B3-ME		01/01-05/04	K16PR-U11	3130	1.1	K16TT	IK16TT	IK16TT		4
1.4 16V	54	B3-BJ		09/98-01/01	K16PR-U11	3130	1.1	K16TT	IK16TT	IK16TT		4
1.5 16V	65	ZL		09/98-01/01	K16PR-U11	3130	1.1	K16TT	IK16TT	IK16TT		4
1.6	70/72	ZM-3; ZM-3(98); ZM-3		01/01-05/04	SKJ20CR-A8	3371	0.8	-	-	-		4
1.8 Astina	92	BP (DOHC)		09/98-05/04	K16PR-U11	3130	1.1	K16TT	IK16TT	IK16TT		4
1.8 Astina	92	BP (DOHC)	OEM Optional	09/98-05/04	K20PR-U11	3121	1.1	K20TT	IK20TT	IK20TT		4
1.9 16V	84	FP-18		09/98-01/01	K16PR-U11	3130	1.1	K16TT	IK16TT	IK16TT		4
2.0	96	FS-7		01/01-05/04	KJ16CR-U11	3311	1.1	K16TT	IK16TT	IK16TT		4
2.0	96	FS-7	OEM Optional	01/01-05/04	KJ20CR-U11	3451	1.1	K20TT	IK20TT	IK20TT		4
2.0 D	52	RF1G		09/98-05/04	DG-502		11V					4
2.0 TD	66/74	RF4F		09/98-05/04	DG-502		11V					4
323 I (77-86)												
1.0	33	PC		06/77-05/80	K16PR-U11	3130	1.1	K16TT	IK16TT	IK16TT		4
1.3	44	TC		05/78-05/86	W16EPR-U	3021	0.8	W16TT	IW16TT	IW16TT		4
1.3	44	TC		01/77-05/80	W20EP-U	3043	0.8	W20TT	IW20TT	IW20TT		4
1.4	51	UC		05/78-05/80	W16EXR-U	3031	0.8	W16TT	IW16TT	IW16TT		4
1.5	50/52	D5		01/82-05/86	W16EPR-U	3021	0.8	W16TT	IW16TT	IW16TT		4
323 II (80-89)												
1.1	40	E1		11/80-10/85	W16EPR-U	3021	0.8	W16TT	IW16TT	IW16TT		4
1.3	44/50	E3		11/80-10/89	K16PR-U	3191	0.8	K16TT	IK16TT	IK16TT		4
1.5	55/59/63/65	D5; E5		05/81-12/85	W16EPR-U	3021	0.8	W16TT	IW16TT	IW16TT		4
323 III (85-95)												
1.1	40	E1		08/85-04/90	W16EXR-U	3031	0.8	W16TT	IW16TT	IW16TT		4
1.3	44/50/52	B315; E3		01/86-04/90	W16EXR-U	3031	0.8	W16TT	IW16TT	IW16TT		4
1.3 i	49	B3E		09/85-08/89	W16EXR-U	3031	0.8	W16TT	IW16TT	IW16TT		4
1.4	44	B3		04/87-10/89	W20EPR-U	3047	0.8	W20TT	IW20TT	IW20TT		4
1.5	54/55	B5; B50; B53; E5		08/85-10/89	W16EXR-U	3031	0.8	W16TT	IW16TT	IW16TT		4
1.5 i	70	E5E3		08/85-05/89	W16EXR-U	3031	0.8	W16TT	IW16TT	IW16TT		4
1.5 i Turbo	85	E5E2		08/85-05/89	W16EXR-U	3031	0.8	W16TT	IW16TT	IW16TT		4
1.5 LX	50	E5		01/86-06/87	W16EXR-U	3031	0.8	W16TT	IW16TT	IW16TT		4
1.6	54/63	B6 (SOHC); B6E; B65M; B68		09/86-10/95	W16EXR-U	3031	0.8	W16TT	IW16TT	IW16TT		4
1.6 4x4	63	B6E; B65M		05/90-03/93	W16EXR-U	3031	0.8	W16TT	IW16TT	IW16TT		4
1.6 GT	63/77	B6 (SOHC)		08/85-08/93	W16EXR-U	3031	0.8	W16TT	IW16TT	IW16TT		4
1.6 GT Turbo	103	B6		10/85-11/91	Q20PR-U	3007	0.8	Q20TT	IQ20TT	IQ20TT		4
1.6 GT Turbo (BF1)	103	B6		10/85-08/93	Q20PR-U	3007	0.8	Q20TT	IQ20TT	IQ20TT		4
1.6 GT Turbo 4WD (BF2)	103/110	B6		08/87-11/91	Q20PR-U	3007	0.8	Q20TT	IQ20TT	IQ20TT		4
1.7 D	40/41/42	PN26; PN27; PN46; PN54		11/86-05/89	DG-311		11V					4
323 P V (96-)												
1.3 16V	54	B3 (16V)		10/96-	K20PR-U11	3121	1.1	K20TT	IK20TT	IK20TT		4
1.5 16V	65	Z5-DE		10/96-07/01	K20PR-U11	3121	1.1	K20TT	IK20TT	IK20TT		4
2.0 D	52	RF1G		10/96-	DG-502		11V					4
323 S IV (89-94)												
1.3	49	B3E		09/89-06/91	W16EPR-U	3021	0.8	W16TT	IW16TT	IW16TT		4
1.3 16V	54	B3 (16V)		04/91-07/94	K16PR-U11	3130	1.1	K16TT	IK16TT	IK16TT		4

	KW					Standard						QTY
MAZDA <i>continued</i>												
323 S IV (89-94) <i>continued</i>												
1.6	62	B6E		09/89-06/91	W16EPR-U11	3201	1.1	W16TT	IW16TT	IW16TT		4
1.6 16V	65	B6		08/89-10/94	W20EPR-U11	3049	1.1	W20TT	IW20TT	IW20TT		4
1.7 D	41	PN46; PN54; PN62		08/89-07/94	DG-311		11V					4
1.8 16V GT	94	BP (DOHC)		06/89-07/94	K20PR-U11	3121	1.1	K20TT	IK20TT	IK20TT		4
1.8 16V Turbo 4WD	120	BP Turbo		01/91-07/94	IK20	5304	1.1	-	IK20TT	IK20TT		4
323 S V (94-98)												
1.3 16V	54	B3 (16V)		08/94-09/98	K16PR-U11	3130	1.1	K16TT	IK16TT	IK16TT		4
1.5 16V	65	Z5-DE		08/94-09/98	K16PR-U11	3130	1.1	K16TT	IK16TT	IK16TT		4
1.6	80	B6 (DOHC)		08/94-09/98	K16PR-U11	3130	1.1	K16TT	IK16TT	IK16TT		4
1.6	80	B6 (DOHC)	OEM Optional	08/94-09/98	K20PR-U11	3121	1.1	K20TT	IK20TT	IK20TT		4
1.6 TD	60	4EE1-T		05/94-09/96	DG-311		11V					4
1.8	92	BP (DOHC)		07/94-09/98	K16PR-U11	3130	1.1	K16TT	IK16TT	IK16TT		4
1.8	92	BP (DOHC)	OEM Optional	07/94-09/98	K20PR-U11	3121	1.1	K20TT	IK20TT	IK20TT		4
1.8 16V	84	BP-ZE		08/94-09/98	K16PR-U11	3130	1.1	K16TT	IK16TT	IK16TT		4
2.0 D	52	RF1G		10/96-09/98	DG-502		11V					4
323 S VI (98-04)												
1.4	53	B3-ME		01/01-05/04	K16PR-U11	3130	1.1	K16TT	IK16TT	IK16TT		4
1.4 16V	54	B3-ME		09/98-01/01	K16PR-U11	3130	1.1	K16TT	IK16TT	IK16TT		4
1.4 16V	54	B3-ME	OEM Optional	09/98-01/01	K16PR-U11	3130	1.1	K16TT	IK16TT	IK16TT		4
1.5 16V	65	ZL		09/98-01/01	K16PR-U11	3130	1.1	K16TT	IK16TT	IK16TT		4
1.6	80	B6 (DOHC)		09/98-02/01	KJ16CR11	3131	1.1	K16TT	IK16TT	IK16TT		4
1.6	70/72	ZM		01/01-05/04	SKJ20CR-A8	3371	0.8	-	-	-		4
1.6	80	B6 (DOHC)	OEM Optional	09/98-02/01	KJ20CR11	3133	1.1	K20TT	IK20TT	IK20TT		4
1.8 Protege	92	BP (DOHC)		05/98-05/04	K16PR-U11	3130	1.1	K16TT	IK16TT	IK16TT		4
1.8 Protege	92	BP (DOHC)	OEM Optional	05/98-05/04	K20PR-U11	3121	1.1	K20TT	IK20TT	IK20TT		4
1.9 16V	84	FP-18		09/98-05/04	K16PR-U11	3130	1.1	K16TT	IK16TT	IK16TT		4
2.0	96	FS7E; FS7G		01/01-05/04	KJ20CR-U11	3451	1.1	K20TT	IK20TT	IK20TT		4
2.0 D	52	RF1G		09/98-05/04	DG-502		11V					4
2.0 DiTD	74	RF4F		10/00-10/02	DG-502		11V					4
2.0 TD	66	RF3F		09/98-05/04	DG-502		11V					4
616 (73-78)												
1.6	55	NA		06/73-02/78	W16EPR-U	3021	0.8	W16TT	IW16TT	IW16TT		4
626 I (79-82)												
1.6	55	NA		05/79-05/82	W20EPR-U	3047	0.8	W20TT	IW20TT	IW20TT		4
2.0	66	M		05/79-05/82	W16EPR-U	3021	0.8	W16TT	IW16TT	IW16TT		4
626 II (82-87)												
1.6	59	F6		11/82-09/87	W16EPR-U	3021	0.8	W16TT	IW16TT	IW16TT		4
2.0	74/88	FE		03/83-09/87	K20PR-U	3145	0.8	K20TT	IK20TT	IK20TT		4
2.0	74/88	FE		03/83-09/87	Q20PR-U	3007	0.8	Q20TT	IQ20TT	IQ20TT		4
2.0	68	FE (8V)		11/86-09/87	W16EPR-U11	3201	1.1	W16TT	IW16TT	IW16TT		4
2.0	81	FE		01/86-10/87	W16EXR-U	3031	0.8	W16TT	IW16TT	IW16TT		4
2.0	68	FE (8V)		01/85-09/87	W20EPR-U	3047	0.8	W20TT	IW20TT	IW20TT		4
2.0 D	46	RF46		01/83-08/85	DG-114		7V					4
2.0 D	46	RF46		08/85-06/87	DG-146		11V					4
2.0 i Turbo	87	FE-EGI		01/86-10/87	W16EXR-U	3031	0.8	W16TT	IW16TT	IW16TT		4
626 III (87-97)												
1.6	60	F659		06/87-05/92	W16EPR-U	3021	0.8	W16TT	IW16TT	IW16TT		4
1.8	65	F8		11/87-05/92	K20PR-U	3145	0.8	K20TT	IK20TT	IK20TT		4
1.8	69			11/87-05/92	W16EPR-U	3021	0.8	W16TT	IW16TT	IW16TT		4
2.0	66	FE		09/87-09/97	K20PR-U	3145	0.8	K20TT	IK20TT	IK20TT		4
2.0 12V	79/81	FE (12V)		03/89-05/92	K20PR-U	3145	0.8	K20TT	IK20TT	IK20TT		4
2.0 12V	79	FE (12V)		09/87-12/88	Q20PR-U	3007	0.8	Q20TT	IQ20TT	IQ20TT		4
2.0 16V	103	FE Kat. (16V)		03/89-05/92	K20PR-U11	3121	1.1	K20TT	IK20TT	IK20TT		4
2.0 16V	109	FE Kat. (16V)		06/87-09/89	Q20PR-U11	3008	1.1	Q20TT	IQ20TT	IQ20TT		4
2.0 4x4	110	FE-FL		08/89-07/91	W16EXR-U	3031	0.8	W16TT	IW16TT	IW16TT		4
2.0 D	44/60	RFG5; RF-N		07/87-09/97	DG-146		11V					4
2.0 D Comprex	55	RF-CX		05/93-11/96	DG-146		11V					4
2.0 GLX	86	FS		04/92-02/95	K20PR-U11	3121	1.1	K20TT	IK20TT	IK20TT		4
2.0 i 16V	110	FECM		11/94-09/97	K20PR-U11	3121	1.1	K20TT	IK20TT	IK20TT		4
2.2 12V	85	F2		11/87-11/96	W16EPR-U	3021	0.8	W16TT	IW16TT	IW16TT		4
2.2 12V 4WD	85	F2		11/87-11/92	W16EPR-U	3021	0.8	W16TT	IW16TT	IW16TT		4
2.2 12V 4WD	85	F2	Ch: >200000	01/90-05/92	QJ20CR11	3112	1.1	Q20TT	IQ20TT	IQ20TT		4
2.2 12V 4WD	85	F2	Ch: 200001>	01/90-05/92	KJ16CR11	3131	1.1	K16TT	IK16TT	IK16TT		4
626 IV (91-97)												
1.8	77	FP		08/91-04/97	K16PR-U11	3130	1.1	K16TT	IK16TT	IK16TT		4
1.8	66			08/94-04/97	K20PR-U11	3121	1.1	K20TT	IK20TT	IK20TT		4

Spark & Glow Plugs







Application Tables







	KW									QTY	
MAZDA <i>continued</i>											
626 IV (91-97) <i>continued</i>											
1.8 i	77	FP		01/92-04/97	K16PR-U11	3130	1.1	K16TT	IK16TT	IK16TT	4
1.8 i	66			08/94-04/97	K20PR-U11	3121	1.1	K20TT	IK20TT	IK20TT	4
2.0 D GLX Complex	55	RF OHC		10/92-12/95	DG-146		11V				4
2.0 i	85	FS		08/91-04/97	K20PR-U11	3121	1.1	K20TT	IK20TT	IK20TT	4
2.0 i 4WD	85	FS		04/92-04/97	K20PR-U11	3121	1.1	K20TT	IK20TT	IK20TT	4
2.5 24V	121	KL		01/92-04/97	KJ16CR11	3131	1.1	K16TT	IK16TT	IK16TT	6
626 V (97-02)											
1.8	66/74	FP; FP9A; FPY3		02/98-10/02	PKJ16CR8	3175	0.8	-	-	VK16	4
1.8	66/74	FP9A; FPY3		05/97-10/02	PKJ20CR8	3173	0.8	-	-	VK20G	4
1.8	66	FP	OEM Optional	10/99-01/00	PKJ20CR8	3173	0.8	-	-	VK20G	4
2.0	85/ 100	FS-115; FS-136		06/00-10/02	PKJ16CR8	3175	0.8	-	-	VK16	4
2.0	85/ 100	FS-115; FS-136	OEM Optional	04/98-10/02	PKJ20CR8	3173	0.8	-	-	VK20G	4
2.0 DI TD	66	RF3F		04/98-10/02	DG-502		11V				4
2.0 DITD	66	RF3F		04/98-10/02	DG-502		11V				4
2.0 H.P.	100	FS-136		02/98-10/02	PKJ16CR8	3175	0.8	-	-	VK16	4
2.0 H.P.	100	FS-136	OEM Optional	06/00-10/02	PKJ20CR8	3173	0.8	-	-	VK20G	4
2.0 TD	81	RF59		10/00-10/02	DG-502		11V				4
2.0 Turbo DI	74	RF4F		04/98-10/02	DG-502		11V				4
818 (74-78)											
1.3	44	TC		01/74-10/78	W20EPR-U	3047	0.8	W20TT	IW20TT	IW20TT	4
1.6	55	NA		01/77-10/78	W20EPR-U	3047	0.8	W20TT	IW20TT	IW20TT	4
929 I (79-86)											
2.0	66	MA		05/79-07/86	W20EPR-U	3047	0.8	W20TT	IW20TT	IW20TT	4
929 II (82-87)											
2.0	74	FE		03/84-07/87	K20PR-U	3145	0.8	K20TT	IK20TT	IK20TT	4
2.0	66/74	FE; MA		01/83-12/87	W20EPR-U	3047	0.8	W20TT	IW20TT	IW20TT	4
2.0 i GLX	88	FE		10/84-07/87	W20EPR-U	3047	0.8	W20TT	IW20TT	IW20TT	4
2.0 i Turbo	88	FE		10/84-07/87	W20EPR-U	3047	0.8	W20TT	IW20TT	IW20TT	4
929 III (87-91)											
2.2 12V	94	F2-C		04/89-06/91	KJ20CR-U11	3451	1.1	K20TT	IK20TT	IK20TT	4
2.2 12V	85	F2E		01/88-04/89	Q20PR-U	3007	0.8	Q20TT	IQ20TT	IQ20TT	4
2.2 i	100	F2-EGl		05/87-12/88	W16EPR-U11	3201	1.1	W16TT	IW16TT	IW16TT	4
3.0	125	JE3		01/88-12/89	QJ20CR11	3112	1.1	Q20TT	IQ20TT	IQ20TT	6
3.0	140	JE	Ch: 631983>	06/87-06/91	KJ16CR11	3131	1.1	K16TT	IK16TT	IK16TT	6
3.0 i	123	JE3		01/90-06/91	KJ16CR11	3131	1.1	K16TT	IK16TT	IK16TT	6
1300 (75-77)											
1.3	44	TC		01/75-01/77	W20EPR-U	3047	0.8	W20TT	IW20TT	IW20TT	4
B-SERIE (77-82)											
1.6	55	NA		02/77-09/78	W16EPR-U	3021	0.8	W16TT	IW16TT	IW16TT	4
1.8	60	VC		02/77-01/82	W16EPR-U	3021	0.8	W16TT	IW16TT	IW16TT	4
B-SERIE (81-85)											
1.8	62	H817		10/81-08/85	IW16	5305	1.1	-	IW16TT	IW16TT	4
B-SERIE (85-99)											
2.0	62/65	FE (8V)		01/85-03/96	W16EPR-U	3021	0.8	W16TT	IW16TT	IW16TT	4
2.2	68	F2L8		08/91-12/96	IW16	5305	1.1	-	IW16TT	IW16TT	4
2.2 D	47	R290		11/89-03/96	DG-146		11V				4
2.5 D	63/64	WL31		02/96-06/99	DG-146		11V				4
2.5 D 4WD	57/ 63/ 64	WL31		04/96-06/99	DG-146		11V				4
2.6 12V 4WD	90	G6MPV		08/91-06/99	KJ16CR11	3131	1.1	K16TT	IK16TT	IK16TT	4
2.6 4WD	73	4G54		01/87-10/90	W16EPR-U	3021	0.8	W16TT	IW16TT	IW16TT	4
B-SERIE (99-)											
2.2 4WD	60	R5-A2	OEM Optional	02/99-01/07	W20EPR-U11	3049	1.1	W20TT	IW20TT	IW20TT	4
2.2 8V 4WD	68	F2-R4	OEM Optional	06/99-01/07	W20EPR-U11	3049	1.1	W20TT	IW20TT	IW20TT	4
2.5 D	57/61	MD25NA; WLE7		06/99-12/06	DG-146		11V				4
2.5 D	62	WLE7		12/02-	DG-311		11V				4
2.5 D 4WD	57/61	MD25NA; WLE7		06/99-12/06	DG-146		11V				4
2.5 D 4WD	62	WLE7		12/02-	DG-311		11V				4
2.5 TD 4WD	80	MD25TI		06/99-07/06	DG-146		11V				4
CX-3 (15-)											
2.0	88			05/15-	VCH20	5637	1.1	-	IXEH22TT	IXEH22TT	4
2.0 AWD	110			05/15-	VCH20	5637	1.1	-	IXEH22TT	IXEH22TT	4
CX-5 (11-)											
2.0	114/ 121	PEY5; PEY6; PEY7		07/12-	VCH20	5637	1.1	-	IXEH22TT	IXEH22TT	4





	KW										QTY
MAZDA <i>continued</i>											
CX-5 (11-) <i>continued</i>											
2.0	121	PEY6; PEY7		11/11-07/12	VFXEH22	5646	1.1	-	IXEH22TT	IXEH22TT	4
2.0 AWD	118	PEY6; PEY7		08/12-	VCH20	5637	1.1	-	IXEH22TT	IXEH22TT	4
2.0 AWD	118	PEY6; PEY7		11/11-07/12	VFXEH22	5646	1.1	-	IXEH22TT	IXEH22TT	4
2.5 AWD	141	PYY1		02/15-	VCH20	5637	1.1	-	IXEH22TT	IXEH22TT	4
CX-7 (07-)											
2.3 MZR DISI Turbo	190/191	L3-VDT		10/07-	ITV22	5340	0.8	-	-	-	4
CX-9 (07-)											
3.5	193			01/07-	ITV16	5338	1.1	-	ITV16TT	ITV16TT	6
3.5 AWD	193			01/07-	ITV16	5338	1.1	-	ITV16TT	ITV16TT	6
3.7	204	CAY1; CAY5; CAY6		01/07-	ITV22	5340	0.8	-	-	-	6
3.7 AWD	204	CA		01/07-	ITV22	5340	0.8	-	-	-	6
DEMIO (98-03)											
1.3 16V	46	B3 ME		08/98-07/07	K16PR-U11	3130	1.1	K16TT	IK16TT	IK16TT	4
1.3 16V	46	B3 ME		07/07-	VFK16		1.1	-	IK16TT	IK16TT	4
1.3 16V	46	B3 ME	LEAN BURN	10/05-07/07	VFK16		1.1	-	IK16TT	IK16TT	4
1.3 i 16V	53	B3 (16V)		08/98-04/00	K16PR-U11	3130	1.1	K16TT	IK16TT	IK16TT	4
1.5 16V	55	B5 E		04/00-07/03	K16PR-U11	3130	1.1	K16TT	IK16TT	IK16TT	4
E-SERIE (SD) (83-04)											
E2000	60/65	FEBN; FE-BN		01/83-05/95	W16EXR-U	3031	0.8	W16TT	IW16TT	IW16TT	4
E2200 D	47	R281		11/88-09/89	DG-114		7V				4
E2200 D	52			09/99-04/02	DG-146		11V				4
E-SERIE (SR) (83-04)											
2200 D 4WD	47	R203; R207		03/91-05/03	DG-114		7V				4
E2000	70	FE (8V)		06/94-05/03	K20PR-U11	3121	1.1	K20TT	IK20TT	IK20TT	4
E2000	60/63	FE-EP		11/84-05/94	W16EXR-U	3031	0.8	W16TT	IW16TT	IW16TT	4
E2000	63	FE-BN; FE-EP	OEM Optional	12/87-04/89	W16EXR-U	3031	0.8	W16TT	IW16TT	IW16TT	4
E2000 4WD	65	FE-BN		01/88-07/91	W16EXR-U	3031	0.8	W16TT	IW16TT	IW16TT	4
E2000 4WD	60	FE-BN	OEM Optional	10/88-09/89	W16EXR-U	3031	0.8	W16TT	IW16TT	IW16TT	4
E2200 D	46/47	R203; R207		05/85-05/03	DG-114		7V				4
E2200 D	52	R2		02/97-08/02	DG-146		11V				4
E2200 D 4WD	47	R2		01/84-02/88	DG-114		7V				4
E2200 D 4WD	52	R2		02/97-05/03	DG-146		11V				4
E-SERIE (80-84)											
E1600	51	NA		08/80-06/84	W16EPR-U	3021	0.8	W16TT	IW16TT	IW16TT	4
MPV I (95-99)											
2.5 TD	85	WL-T		05/96-09/99	DG-146		11V				4
3.0 i V6	109	JE94	Ch: 631983>	05/96-09/99	KJ16CR11	3131	1.1	K16TT	IK16TT	IK16TT	6
3.0 i V6 (LV10)	113	JE94		03/95-09/99	KJ16CR11	3131	1.1	K16TT	IK16TT	IK16TT	6
MPV II (99-06)											
2.0	88/90	FS-D		09/99-07/02	KJ16CR-U11	3311	1.1	K16TT	IK16TT	IK16TT	4
2.0 DI	100	RF5C		07/02-02/06	DG-502		11V				4
2.3	104	L3		07/02-02/06	ZT20EPR11	5087	1.1	T20TT	IT20TT	IT20TT	4
2.3	104	L3	OEM Optional	07/02-02/06	VT16	5621	1.1	-	IT16TT	IT16TT	4
2.5 V6	125	GY-DE		09/99-11/01	PT16EPR-L13	5070	1.3	-	IT16TT	IT16TT	6
2.5 V6	125	GY-DE		12/01-03/02	ZT20EPR11	5087	1.1	T20TT	IT20TT	IT20TT	6
3.0 i V6	147	AJ		03/02-02/06	IT20	5326	1.1	-	IT20TT	IT20TT	6
MPV III (06-)											
2.3	120	L3-VE		02/06-	ZT20EPR11	5087	1.1	T20TT	IT20TT	IT20TT	4
2.3 4WD	120	L3-VE		02/06-	ZT20EPR11	5087	1.1	T20TT	IT20TT	IT20TT	4
MX-3 (91-98)											
1.6 i	65/79	B6D; B69		07/91-	K16PR-U11	3130	1.1	K16TT	IK16TT	IK16TT	4
1.8 i V6	95	K838		01/94-12/98	IK16	5303	1.1	-	IK16TT	IK16TT	6
1.8 i V6	98	K819		01/92-01/94	K16PR-U11	3130	1.1	K16TT	IK16TT	IK16TT	6
MX-5 I (90-98)											
1.6	66/85	8AN1; B64F		05/90-04/98	K20PR-U11	3121	1.1	K20TT	IK20TT	IK20TT	4
1.8	96	BPF1		09/93-04/98	IK20	5304	1.1	-	IK20TT	IK20TT	4
MX-5 II (98-05)											
1.6 16V	81	B6-4J		05/98-10/05	K16PR-U11	3130	1.1	K16TT	IK16TT	IK16TT	4
1.8	103/107	BPD		01/98-10/05	K20PR-U11	3121	1.1	K20TT	IK20TT	IK20TT	4
1.8 16V	102/103/107	BPD; BP-ZE		11/00-10/05	K20PR-U11	3121	1.1	K20TT	IK20TT	IK20TT	4
1.8 i Turbo	136	BP Turbo		04/02-10/05	IK20	5304	1.1	-	IK20TT	IK20TT	4
MX-5 III (05-)											
1.8	93	MZR18(126)		03/05-	VT16	5621	1.1	-	IT16TT	IT16TT	4
2.0	118	MZR20		09/08-	ITV20	5339	1.1	-	ITV20TT	ITV20TT	4









Spark & Glow Plugs











Application Tables







	KW				Standard 			Twin Tip 				QTY
MAZDA continued												
MX-5 IV (15-)												
1.5	96	P5-VPR		04/15-	VCH20	5637	1.1	-	IXEH22TT	IXEH22TT		4
MX-6 (92-97)												
2.0	85	FS-19		02/92-02/97	K16PR-U11	3130	1.1	K16TT	IK16TT	IK16TT		4
2.5 24V	121	KL-19		02/92-02/97	KJ16CR-U11	3311	1.1	K16TT	IK16TT	IK16TT		6
2.5 i 24V	120	KL-20		08/94-02/97	KJ16CR-U11	3311	1.1	K16TT	IK16TT	IK16TT		6
PREMACY (99-05)												
1.9	74/84	FP; FP-18		07/99-06/01	K16PR-U11	3130	1.1	K16TT	IK16TT	IK16TT		4
1.9	84	FP-E1		07/01-03/05	KJ16CR-U11	3311	1.1	K16TT	IK16TT	IK16TT		4
2.0	96	FS-7E;FS-7G		11/01-03/05	KJ16CR-U11	3311	1.1	K16TT	IK16TT	IK16TT		4
2.0 TD	66/74	RF3F; RF4F		10/99-03/05	DG-502		11V					4
RX 5 (75-81)												
1.1 Wankel	92	12A(125);13B		06/75-12/79	W22EBR	3082	1.1	-	-	-		2
RX 7 I (79-86)												
Wankel	77/85	12A(115); 12AN2		05/79-01/83	W22EBR	3082	1.1	-	-	-		2
Wankel	83	12AN2		03/84-03/86	W27EBR	3107	1.1	-	-	-		2
RX 7 II (85-91)												
Turbo	133	RE13B		06/87-11/89	S-31A	3111	1.95	-	-	-		2
Turbo	147	13B-MSP; RE13B		03/89-12/91	W27EBR	3107	1.1	-	-	-		2
Wankel	110	RE13B		11/85-04/89	W29EBR	3310	1.1	-	-	-		2
RX 7 III (92-02)												
Wankel Twin Turbo	176	13BREW		07/92-01/96	W27EBR	3107	1.1	-	-	-		2
RX 8 (03-12)												
2.6 Wankel	141/ 170/ 177	13B-MSP		10/03-03/08	IRT01-31	5752	1.1	-	-	-		2
2.6 Wankel	141/ 170/ 177	13B-MSP	Twin Spark Exhaust side	04/08-06/12	IRT01-31	5752	1.1	-	-	-		2
2.6 Wankel	141/ 170/ 177	13B-MSP	Twin Spark Intake side	04/08-06/12	IRL01-27	5754	1.1	-	-	-		2
TRIBUTE (00-08)												
2.0	91	YF		03/00-02/05	PT16VR13	5068	1.3	TV16TT	ITV16TT	ITV16TT		4
2.0 4WD	91	YF		03/00-12/03	PT16VR13	5068	1.3	TV16TT	ITV16TT	ITV16TT		4
2.3 All-wheel Drive	109	L3		07/06-05/08	ZT20EPR11	5087	1.1	T20TT	IT20TT	IT20TT		4
2.3 AWD	110	L3-VE		04/04-05/08	ZT20EPR11	5087	1.1	T20TT	IT20TT	IT20TT		4
2.3 AWD	110	L3	OEM Optional	04/04-05/08	VT16	5621	1.1	-	IT16TT	IT16TT		4
2.3 GX	110	L3-VE		12/03-10/04	ZT20EPR11	5087	1.1	T20TT	IT20TT	IT20TT		4
3.0 V6 24V 4WD	145	AJ		03/00-05/08	IT20	5326	1.1	-	IT20TT	IT20TT		6
3.0 V6 AWD	149	AJ		04/04-05/08	IT20	5326	1.1	-	IT20TT	IT20TT		6
VERISA (04-)												
1.5	83			07/04-09/06	K16PR-U11	3130	1.1	K16TT	IK16TT	IK16TT		4
1.5	83			09/06-	VFK16		1.1	-	IK16TT	IK16TT		4
XEDOS 6 (92-99)												
1.6 16V	79	B6		06/94-10/99	K16PR-U11	3130	1.1	K16TT	IK16TT	IK16TT		4
1.6 16V	83	B69		08/92-05/94	K20PR-U11	3121	1.1	K20TT	IK20TT	IK20TT		4
2.0 V6	103/ 106	KF1		01/92-10/99	K20PR-U11	3121	1.1	K20TT	IK20TT	IK20TT		6
XEDOS 9 (93-02)												
2.0 24V	105	KF		08/93-01/00	K16PR-U11	3130	1.1	K16TT	IK16TT	IK16TT		6
2.3 24V	155	KJ-ZEM		02/95-01/00	PKJ16CR8	3175	0.8	-	-	VK16		6
2.3 24V	155	KJ-ZEM	OEM Optional	02/95-01/00	SKJ20CR-A8	3371	0.8	-	-	-		6
2.5 24V	123	K8-ZE25		07/93-07/00	KJ20CR-U11	3451	1.1	K20TT	IK20TT	IK20TT		6
2.5 24V	123	K8-ZE25	OEM Optional	07/93-07/00	KJ16CR-U11	3311	1.1	K16TT	IK16TT	IK16TT		6
2.5 V6	120	K8-ZE25		07/00-09/02	KJ20CR-U11	3451	1.1	K20TT	IK20TT	IK20TT		6
2.5 V6	120	K8-ZE25	OEM Optional	07/00-09/02	KJ16CR-U11	3311	1.1	K16TT	IK16TT	IK16TT		6
MERCEDES-BENZ												
100 (631) (88-96)												
D (631.332, 631.342)	53/55	OM 616.963		02/88-02/91	DG-001		11V					4
D (631.332, 631.342)	53/55	OM 616.963		12/90-02/96	DG-010		11.5V					4
D (631.333, 631.343, 631.334, 631.344)	53/55	OM 616.963; OM 616		02/88-02/91	DG-001		11V					4
D (631.333, 631.343, 631.334, 631.344)	53/55	OM 616.963; OM 616		12/90-02/96	DG-010		11.5V					4
D (631.340)	53	OM 616.963		02/88-01/89	DG-001		11V					4
D (631.340)	53/55	OM 616.963		02/89-02/96	DG-010		11.5V					4
D	41	OM 616		12/90-12/94	DG-001		11V					4
190 (W201) (82-93)												
2.0 (201.022)	66	M 102.921		10/82-10/84	T20EP-U	5031	0.8	T20TT	IT20TT	IT20TT		4
2.0 (201.023)	75/77	M 102.924		09/84-05/90	T20EP-U	5031	0.8	T20TT	IT20TT	IT20TT		4





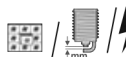

	KW					Standard		Twin Tip		QTY	
MERCEDES-BENZ <i>continued</i>											
190 (W201) (82-93) <i>continued</i>											
D 2.0 (201.122)	53	OM 601.911		08/83-01/89	DG-001		11V			4	
D 2.0 (201.122)	53/55	OM 601.911		02/89-08/93	DG-010		11.5V			4	
D 2.5 (201.126)	66	OM 602.911		04/85-01/89	DG-001		11V			5	
D 2.5 (201.126)	66/69	OM 602.911		02/89-08/93	DG-010		11.5V			5	
E 1.8 (201.018)	80	M 102.910		04/90-08/93	T20EP-U	5031	0.8	T20TT	IT20TT	IT20TT	4
E 2.0	87	M 102.962		01/85-08/93	T20EP-U	5031	0.8	T20TT	IT20TT	IT20TT	4
E 2.0 (201.024)	83/90	M 102.961; M 102.962		10/82-06/93	T20EP-U	5031	0.8	T20TT	IT20TT	IT20TT	4
E 2.3	97	M 102.985		09/86-08/91	T20EP-U	5031	0.8	T20TT	IT20TT	IT20TT	4
E 2.3 (201.028)	100	M 102.985		10/86-08/93	T20EP-U	5031	0.8	T20TT	IT20TT	IT20TT	4
E 2.3-16 (201.034)	136	M 102.983		04/84-01/87	T22EP-U	5040	0.8	-	-	-	4
E 2.5-16	143	M 102.991		03/89-08/93	T20EP-U	5031	0.8	T20TT	IT20TT	IT20TT	4
E 2.6	122	M 103.942		09/86-12/89	T20EP-U	5031	0.8	T20TT	IT20TT	IT20TT	6
E 2.6 (201.029)	118	M 103.942		09/86-08/93	T20EP-U	5031	0.8	T20TT	IT20TT	IT20TT	6
E Evolution II 2.5	173	M 102.992		05/90-08/93	T20EP-U	5031	0.8	T20TT	IT20TT	IT20TT	4
Turbo-D 2.5 (201.128)	90/93	OM 602.961		02/88-08/93	DG-010		11.5V			5	
A-CLASS (W168) (97-04)											
A 140 (168.031, 168.131)	60	M 166.940; M 166.960		07/97-08/04	K20PBR-S10	5061	1.0	K20TT	IK20TT	IK20TT	4
A 160 (168.033, 168.133)	75	M 166.960		07/97-08/04	K20PBR-S10	5061	1.0	K20TT	IK20TT	IK20TT	4
A 160 CDI (168.006)	55	OM 668.940		02/01-08/04	DG-155		11.5V			4	
A 160 CDI (168.007)	44	OM 668.941		07/98-02/01	DG-155		11.5V			4	
A 170 CDI (168.008)	66	OM 668.940		07/98-02/01	DG-155		11.5V			4	
A 170 CDI (168.009, 168.109)	70	OM 668.942		02/01-08/04	DG-155		11.5V			4	
A 190 (168.032, 168.132)	92	M 166.990		03/99-08/04	K20PBR-S10	5061	1.0	K20TT	IK20TT	IK20TT	4
A 210 (168.035, 168.135)	103	M 166.995		03/02-08/04	K20PBR-S10	5061	1.0	K20TT	IK20TT	IK20TT	4
A-CLASS (W169) (04-12)											
A 150 (169.031, 169.331)	70	M 266.920		09/04-03/08	K20PR-U11	3121	1.1	K20TT	IK20TT	IK20TT	4
A 160 (169.031, 169.331)	70	M 266.920		04/09-06/12	K20PR-U11	3121	1.1	K20TT	IK20TT	IK20TT	4
A 160 CDI (169.006, 169.306)	60	640.942		09/04-03/08	DG-194		4.4V			4	
A 170 (169.032, 169.332)	85	M 266.940		09/04-03/08	K20PR-U11	3121	1.1	K20TT	IK20TT	IK20TT	4
A 180 (169.032, 169.332)	85	M 266.940		04/09-06/12	K20PR-U11	3121	1.1	K20TT	IK20TT	IK20TT	4
A 180 CDI (169.007, 169.307)	80	640.94		09/04-03/08	DG-194		4.4V			4	
A 200 (169.033, 169.333)	100	M 266.960		09/04-06/12	K20PR-U11	3121	1.1	K20TT	IK20TT	IK20TT	4
A 200 CDI (169.008, 169.308)	103	640.941		09/04-03/08	DG-194		4.4V			4	
A 200 TURBO (169.034, 169.334)	142	M 266.980		09/05-06/12	SK20PR-L9	3307	0.9	-	IK20TT	IK20TT	4
A-CLASS (W176) (12-)											
A 160 CDI (176.011)	66	OM 607.951		06/13-	DG-609		4.4V			4	
A 180 CDI (176.012)	80	OM 607.951		06/12-	DG-609		4.4V			4	
B-CLASS (W245) (05-11)											
B 150 (245.231)	70	M 266.920		03/05-03/08	K20PR-U11	3121	1.1	K20TT	IK20TT	IK20TT	4
B 160 (245.231)	70	M 266.920		04/09-11/11	K20PR-U11	3121	1.1	K20TT	IK20TT	IK20TT	4
B 170 (245.232)	85	M 266.940		03/05-03/08	K20PR-U11	3121	1.1	K20TT	IK20TT	IK20TT	4
B 170 NGT (245.233)	85	M 266.960	Flexible fuel	04/08-06/09	K20PR-U11	3121	1.1	K20TT	IK20TT	IK20TT	4
B 180 (245.232)	85	M 266.940		04/09-11/11	K20PR-U11	3121	1.1	K20TT	IK20TT	IK20TT	4
B 180 CDI (245.207)	80	OM 640.940		03/05-11/11	DG-194		4.4V			4	
B 180 NGT (245.233)	85	M 266.960	Flexible fuel	06/09-11/11	K20PR-U11	3121	1.1	K20TT	IK20TT	IK20TT	4
B 200 (245.233)	100	M 266.960		03/05-11/11	K20PR-U11	3121	1.1	K20TT	IK20TT	IK20TT	4
B 200 CDI	100	OM 640.941		03/05-11/11	DG-194		4.4V			4	
B 200 CDI (245.208)	103	OM 640.941		03/05-11/11	DG-194		4.4V			4	
B 200 TURBO (245.234)	142	M 266.980		03/05-11/11	SK20PR-L9	3307	0.9	-	IK20TT	IK20TT	4
B-CLASS (W246) (11-)											
B 160 CDI (246.211)	66	OM 607.951		05/13-	DG-609		4.4V			4	
B 180 CDI (246.212)	80	OM 607.951		02/13-	DG-609		4.4V			4	
CABRIOLET (A124) (92-93)											
300 CE-24 (124.061)	162	M 104.980		04/92-06/93	Q20P-U	3125	0.8	Q20TT	IQ20TT	IQ20TT	6
C-CLASS (202) (93-01)											
C 36 AMG (202.028)	206	M 104.941 (AMG 3.6)		05/94-01/98	K20TXR	5063	1.0	K20TT	IK20TT	IK20TT	6
C 43 AMG (202.033)	225	M 113.944		08/97-05/00	PK20PR11	3168	1.1	K20TT	IK20TT	IK20TT	8
C 43 AMG (202.093)	225	M 113.944		08/97-03/01	PK16PR11	3264	1.1	K16TT	IK16TT	IK16TT	16
C 180 (202.018)	89/90	M 111.920; M 111.921		11/94-05/00	K16TNR-S9	3329	0.9	K16TT	IK16TT	IK16TT	4
C 180 (202.018)	90	M 111.920; M 111.921		03/93-06/97	Q20P-U	3125	0.8	Q20TT	IQ20TT	IQ20TT	4







	KW				Standard			Twin Tip				QTY
MERCEDES-BENZ <i>continued</i>												
C-CLASS (202) (93-01) <i>continued</i>												
C 180 T (202.078)	90	M 111.920; M 111.921		07/97-09/00	K16TNR-S9	3329	0.9	K16TT	IK16TT	IK16TT		4
C 180 T (202.078)	90	M 111.920; M 111.921		06/96-06/97	Q20P-U	3125	0.8	Q20TT	IQ20TT	IQ20TT		4
C 180 T (202.081)	95	M 111.952		09/00-03/01	VK20	5604	1.1	-	IK20TT	IK20TT		4
C 200 (202.020)	100	M 111.941; M 111.945		01/94-06/97	Q20P-U	3125	0.8	Q20TT	IQ20TT	IQ20TT		4
C 200 CDI (202.134)	75	OM 611.960		03/98-05/00	DG-117		11.5V					4
C 200 D (202.120)	55	OM 601.913		03/93-05/00	DG-010		11.5V					4
C 200 D (202.122)	65	OM 604.915		10/96-05/00	DG-106		11.5V					4
C 200 Kompressor (202.025)	132/141	M 111.944		10/95-05/00	K20PBR-S10	5061	1.0	K20TT	IK20TT	IK20TT		4
C 200 T (202.080)	100	M 111.941; M 111.945		06/96-03/01	Q20P-U	3125	0.8	Q20TT	IQ20TT	IQ20TT		4
C 200 T CDI (202.194)	75	OM 611.960		03/98-03/01	DG-117		11.5V					4
C 200 T D (202.180)	65	OM 604.915		10/96-03/01	DG-106		11.5V					4
C 200 T Kompressor (202.087)	120	M 111.956		09/00-03/01	VK20	5604	1.1	-	IK20TT	IK20TT		4
C 200 T Kompressor (202.082)	141	M 111.944		11/96-03/01	K20PBR-S10	5061	1.0	K20TT	IK20TT	IK20TT		4
C 220 (202.022)	110	M 111.961		03/93-05/00	Q20P-U	3125	0.8	Q20TT	IQ20TT	IQ20TT		4
C 220 CDI (202.133)	92	OM 611.960		09/97-05/00	DG-117		11.5V					4
C 220 D	55	OM 604.910	Eng: >021.055	07/96-05/00	DG-119		11.5V					4
C 220 D	55	OM 604.910	Eng: 021.056>	07/96-05/00	DG-106		11.5V					4
C 220 D (202.121)	70	OM 604.910	Eng: >021.055	08/93-05/00	DG-119		11.5V					4
C 220 D (202.121)	70	OM 604.910	Eng: 021.056>	08/93-05/00	DG-106		11.5V					4
C 220 T CDI (202.193)	92	OM 611.960		09/97-03/01	DG-117		11.5V					4
C 220 T D	55	OM 604.910	With Immobilizer, Eng: >021.055	06/96-03/01	DG-106		11.5V					4
C 220 T D (202.182)	70	OM 604.910	Eng: >021.055	06/96-09/98	DG-119		11.5V					4
C 220 T D (202.182)	70	OM 604.910	Eng: 021.056>	06/96-09/98	DG-010		11.5V					4
C 230 (202.023)	110	M 111.974		06/96-06/97	Q20P-U	3125	0.8	Q20TT	IQ20TT	IQ20TT		4
C 230 Kompressor (202.024)	142	M 111.975		10/95-05/00	K20PBR-S10	5061	1.0	K20TT	IK20TT	IK20TT		4
C 230 T (202.083)	110	M 111.974		06/96-06/98	Q20P-U	3125	0.8	Q20TT	IQ20TT	IQ20TT		4
C 230 T Kompressor (202.085)	142	M 111.975		06/97-09/00	K20PBR-S10	5061	1.0	K20TT	IK20TT	IK20TT		4
C 240 (202.026)	125	M 112.910		06/97-05/00	PK16PR-L11	3275	1.1	-	IK16TT	IK16TT		12
C 240 T (202.086)	125	M 112.910		06/97-09/00	PK16PR-L11	3275	1.1	-	IK16TT	IK16TT		12
C 240 T (202.088)	125	M 112.915		09/00-03/01	PK16PR11	3264	1.1	K16TT	IK16TT	IK16TT		12
C 250 D (202.125)	83	OM 605.910		05/93-05/00	DG-119		11.5V					5
C 250 D (202.125)	83	OM 605.910	With Immobilizer	05/93-05/00	DG-106		11.5V					5
C 250 T Turbo-D (202.188)	110	OM 605.960		06/96-03/01	DG-106		11.5V					5
C 250 Turbo-D (202.128)	110	OM 605.960		10/95-05/00	DG-106		11.5V					5
C 280 (202.028)	142	M 104.941		05/93-05/00	Q20P-U	3125	0.8	Q20TT	IQ20TT	IQ20TT		6
C 280 (202.029)	145	M 112.920		06/97-05/00	PK16PR-L11	3275	1.1	-	IK16TT	IK16TT		12
C 280 T (202.089)	145	M 112.920		06/97-03/01	PK16PR-L11	3275	1.1	-	IK16TT	IK16TT		12
C-CLASS (203) (00-07)												
C 30 CDI AMG (203.018)	170	OM 612.990		01/03-02/07	DG-192		5V					5
C 30 CDI AMG (203.218)	170	OM 612.990		01/03-08/07	DG-192		5V					5
C 32 AMG Kompressor (203.065)	260	M 112.961		02/01-12/03	SK20PR-L9	3307	0.9	-	IK20TT	IK20TT		12
C 32 AMG Kompressor (203.265)	260	M 112.961		03/01-12/03	SK20PR-L9	3307	0.9	-	IK20TT	IK20TT		12
C 55 AMG (203.076)	270	M 113.988		02/04-02/07	SK20PR-L9	3307	0.9	-	IK20TT	IK20TT		16
C 55 AMG (203.276)	270	M 113.988		02/04-08/07	SK20PR-L9	3307	0.9	-	IK20TT	IK20TT		16
C 180 (203.035)	95	M 111.951		10/00-05/02	SK20PR-L9	3307	0.9	-	IK20TT	IK20TT		4
C 180 (203.235)	95	M 111.951		03/01-05/02	SK20PR-L9	3307	0.9	-	IK20TT	IK20TT		4
C 180 Kompressor (203.046)	105	M 271.946		05/02-02/07	VKH20	5618	1.1	-	IKH20TT	IKH20TT		4
C 180 Kompressor (203.246)	105	M 271.946		05/02-08/07	VKH20	5618	1.1	-	IKH20TT	IKH20TT		4
C 200 CDI	75	OM 646.962		02/01-02/07	DG-117		11.5V					4
C 200 CDI (203.004)	85	OM 611.962		09/00-02/07	DG-117		11.5V					4
C 200 CDI (203.007)	90	OM 646.962		04/03-02/07	DG-117		11.5V					4







	KW					Standard				QTY
MERCEDES-BENZ <i>continued</i>										
C-CLASS (203) (00-07) <i>continued</i>										
C 200 CDI (203.204)	85	OM 611.962		03/01-08/07	DG-117		11.5V			4
C 200 CDI (203.204, 203.207)	75	OM 611.962; OM 646.962		03/01-08/07	DG-117		11.5V			4
C 200 CDI (203.207)	90	OM 646.962		04/03-08/07	DG-117		11.5V			4
C 200 CGI Kompressor (203.043)	125	M 271.942		07/03-02/07	VKH20	5618	1.1	-	IKH20TT	4
C 200 CGI Kompressor (203.243)	125	M 271.942		07/03-08/07	VKH20	5618	1.1	-	IKH20TT	4
C 200 Kompressor (203.042)	120	M 271.940		05/02-02/07	VKH20	5618	1.1	-	IKH20TT	4
C 200 Kompressor (203.045)	120	M 111.955		05/00-06/02	SK20PR-L9	3307	0.9	-	IK20TT	4
C 200 Kompressor (203.242)	120	M 271.940		05/02-08/07	VKH20	5618	1.1	-	IKH20TT	4
C 200 Kompressor (203.245)	120	M 111.955		03/01-05/02	SK20PR-L9	3307	0.9	-	IK20TT	4
C 220 CDI (203.006)	100/105	OM 611.962		05/00-02/07	DG-117		11.5V			4
C 220 CDI (203.008)	110	OM 646.963		02/03-02/07	DG-117		11.5V			4
C 220 CDI (203.206)	105	OM 611.962		03/01-08/07	DG-117		11.5V			4
C 220 CDI (203.208)	110	OM 646.963		02/04-08/07	DG-117		11.5V			4
C 230 (203.052)	150	M 272.920		01/05-02/07	SXU22HDR8	3441	0.8	-	-	VXUH22
C 230 (203.252)	150	M 272.920		01/05-08/07	SXU22HDR8	3441	0.8	-	-	VXUH22
C 230 Kompressor (203.040)	141	M 271.948		02/04-02/07	VKH20	5618	1.1	-	IKH20TT	4
C 230 Kompressor (203.240)	141	M 271.948		02/04-08/07	VKH20	5618	1.1	-	IKH20TT	4
C 240 (203.061)	125	M 112.912		05/00-02/07	PK16PR-L11	3275	1.1	-	IK16TT	12
C 240 (203.261)	125	M 112.912		03/01-08/07	PK16PR-L11	3275	1.1	-	IK16TT	12
C 240 4-matic (203.081)	125	M 112.916		07/02-02/07	PK16PR-L11	3275	1.1	-	IK16TT	12
C 240 4-matic (203.281)	125	M 112.916		07/02-08/07	PK16PR-L11	3275	1.1	-	IK16TT	12
C 270 CDI (203.016)	125	OM 612.962		12/00-02/07	DG-117		11.5V			5
C 270 CDI (203.216)	125	OM 612.962		03/01-08/07	DG-117		11.5V			5
C 280 (203.054)	170	M 272.940		01/05-02/07	SXU22HDR8	3441	0.8	-	-	VXUH22
C 280 (203.254)	170	M 272.940		01/05-08/07	SXU22HDR8	3441	0.8	-	-	VXUH22
C 280 4-matic (203.092)	170	M 272.941		01/05-02/07	SXU22HDR8	3441	0.8	-	-	VXUH22
C 280 4-matic (203.292)	170	M 272.941		01/05-08/07	SXU22HDR8	3441	0.8	-	-	VXUH22
C 320 (203.064)	160	M 112.946		05/00-02/07	PK16PR-L11	3275	1.1	-	IK16TT	12
C 320 (203.264, 203.764)	160	M 112.946		03/01-08/07	PK16PR-L11	3275	1.1	-	IK16TT	12
C 320 4-matic (203.084)	160	M 112.953		07/02-02/07	PK16PR-L11	3275	1.1	-	IK16TT	12
C 320 4-matic (203.284)	160	M 112.953		07/02-08/07	PK16PR-L11	3275	1.1	-	IK16TT	12
C 320 CDI (203.020)	165	642.91		01/05-02/07	DG-194		4.4V			6
C 320 CDI (203.220)	165	OM 642.910		06/05-08/07	DG-194		4.4V			6
C 350 (203.056)	200	M 272.960		01/05-02/07	SXU22HDR8	3441	0.8	-	-	VXUH22
C 350 (203.256)	200	M 272.960		01/05-08/07	SXU22HDR8	3441	0.8	-	-	VXUH22
C 350 4-matic (203.087)	200	M 272.960; M 272.970		01/05-02/07	SXU22HDR8	3441	0.8	-	-	VXUH22
C 350 4-matic (203.287)	200	M 272.970		01/05-08/07	SXU22HDR8	3441	0.8	-	-	VXUH22
C-CLASS (204) (07-)										
C 63 AMG (204.077)	336/358	M 156.985		02/08-	VFXEH22	5646	1.1	-	IXEH22TT	8
C 63 AMG (204.277)	336/358	M 156.985		02/08-	VFXEH22	5646	1.1	-	IXEH22TT	8
C 180 CGI (204.049)	115	M 271.820		10/09-	VXUH22	5611	0.9	-	-	VXUH22
C 180 CGI (204.249)	115	M 271.820		03/11-	VXUH22	5611	0.9	-	-	VXUH22
C 180 Kompressor (204.044, 204.045)	115	M 271.910		01/08-	VXUH22	5611	0.9	-	-	VXUH22
C 180 Kompressor (204.046)	115	M 271.952	Ch: 30853900>	01/07-02/11	VXUH22	5611	0.9	-	-	VXUH22
C 180 Kompressor (204.245)	115	M 271.910		01/08-	VXUH22	5611	0.9	-	-	VXUH22
C 180 Kompressor (204.246)	115	M 271.952		10/09-02/11	VXUH22	5611	0.9	-	-	VXUH22
C 180 Kompressor (204.246)	115	M 271.952	Ch: 30853900>	08/07-02/11	VXUH22	5611	0.9	-	-	VXUH22
C 200 CDI (204.007)	100	646.812(136) - E5		01/07-02/11	DG-194		4.4V			4
C 200 CGI (204.048)	135	M 271.820		10/09-	VXUH22	5611	0.9	-	-	VXUH22
C 200 CGI (204.248)	135	M 271.820; M 271.860		08/07-	VXUH22	5611	0.9	-	-	VXUH22
C 200 Kompressor (204.041)	135	M 271.950	Ch: 30853900>	01/07-02/11	VXUH22	5611	0.9	-	-	VXUH22
C 200 Kompressor (204.241)	135	M 271.950		10/09-02/11	VXUH22	5611	0.9	-	-	VXUH22
C 200 Kompressor (204.241)	135	M 271.950	Ch: 30853900>	08/07-02/11	VXUH22	5611	0.9	-	-	VXUH22







	KW				Standard			Twin Tip			QTY	
												
MERCEDES-BENZ <i>continued</i>												
C-CLASS (204) (07-) <i>continued</i>												
C 230 (204.052)	150	M 272.921		01/07-02/11	SXU22HDR8	3441	0.8	-	-	VXUH22	6	
C 230 (204.252)	150	M 272.921		08/07-02/11	SXU22HDR8	3441	0.8	-	-	VXUH22	6	
C 230 4-matic (204.085)	150	M 272.911		07/07-02/11	SXU22HDR8	3441	0.8	-	-	VXUH22	6	
C 250 CDI (204.003)	150	651.911(204) - E5		08/08-02/11	DG-194		4.4V				4	
C 250 CGI (204.047)	150	M 271.860		07/09-	VXUH22	5611	0.9	-	-	VXUH22	4	
C 250 CGI (204.247)	150	M 271.860		07/09-	VXUH22	5611	0.9	-	-	VXUH22	4	
C 280 (204.054)	170	M 272.947		01/07-06/09	SXU22HDR8	3441	0.8	-	-	VXUH22	6	
C 280 (204.254)	170	M 272.947		08/07-02/11	SXU22HDR8	3441	0.8	-	-	VXUH22	6	
C 280 4-matic (204.081)	170	M 272.948		07/07-06/09	SXU22HDR8	3441	0.8	-	-	VXUH22	6	
C 300 (204.054)	170	M 272.947		07/09-02/11	SXU22HDR8	3441	0.8	-	-	VXUH22	6	
C 300 4-matic (204.081)	170	M 272.948		01/10-02/11	SXU22HDR8	3441	0.8	-	-	VXUH22	6	
C 320 CDI (204.022)	165	OM 642.960		01/07-02/11	DG-194		4.4V				6	
C 320 CDI (204.222)	165	642.96		08/07-02/11	DG-194		4.4V				6	
C 320 CDI 4-matic (204.089)	165	OM 642.961		07/07-04/09	DG-194		4.4V				6	
C 320 CDI 4-matic (204.289)	165	OM 642.961		08/07-04/09	DG-194		4.4V				6	
C 350 (204.056)	200	M 272.961		01/07-02/11	SXU22HDR8	3441	0.8	-	-	VXUH22	6	
C 350 (204.256)	200	M 272.961		08/07-02/11	SXU22HDR8	3441	0.8	-	-	VXUH22	6	
C 350 4-matic (204.087)	200	M 272.971		07/07-02/11	SXU22HDR8	3441	0.8	-	-	VXUH22	6	
C 350 CDI (204.022)	165	OM 642.960		07/09-02/11	DG-194		4.4V				6	
C 350 CGI (204.065)	215	M 272.982		09/08-02/11	VXUH22I	5656	0.9	-	-	VXUH22I	6	
C-CLASS Coupe (C204) (11-)												
C 63 AMG (204.377)	336/ 358/ 380	M 156.985		06/11-	VFXEH22	5646	1.1	-	-	IXEH22TT	IXEH22TT	8
C 180 (204.349)	115	M 271.820		06/11-	VXUH22	5611	0.9	-	-	VXUH22	4	
C 200 CGI (204.348)	135	M 271.820		06/11-	VXUH22	5611	0.9	-	-	VXUH22	4	
C 250 (204.347)	150	M 271.860		06/11-	VXUH22	5611	0.9	-	-	VXUH22	4	
C-CLASS Coupe (CL203) (01-08)												
C 30 CDI AMG (203.718)	170	OM 612.990		09/02-05/08	DG-192		5V				5	
C 160 Kompressor (203.730)	90	M 271.921		01/04-02/08	VKH20	5618	1.1	-	-	IKH20TT	IKH20TT	4
C 180 (203.735)	95	M 111.951		03/01-05/02	SK20PR-L9	3307	0.9	-	-	IK20TT	IK20TT	4
C 180 Kompressor (203.746)	105	M 271.946		05/02-02/08	VKH20	5618	1.1	-	-	IKH20TT	IKH20TT	4
C 200 CDI (203.707)	90	OM 646.962		03/03-05/08	DG-117		11.5V				4	
C 200 CGI Kompressor (203.743)	125	M 271.942		03/03-02/08	VKH20	5618	1.1	-	-	IKH20TT	IKH20TT	4
C 200 Kompressor (203.742)	120	M 271.940		05/02-02/08	VKH20	5618	1.1	-	-	IKH20TT	IKH20TT	4
C 200 Kompressor (203.745)	120	M 111.955		03/01-05/02	SK20PR-L9	3307	0.9	-	-	IK20TT	IK20TT	4
C 220 CDI (203.706)	105	OM 611.962		03/01-05/08	DG-117		11.5V				4	
C 220 CDI (203.708)	110	OM 646.963		02/04-05/08	DG-117		11.5V				4	
C 230 (203.752)	150	M 272.920		01/05-02/08	SXU22HDR8	3441	0.8	-	-	VXUH22	6	
C 230 Kompressor (203.740)	141	M 271.948		05/02-02/08	VKH20	5618	1.1	-	-	IKH20TT	IKH20TT	4
C 230 Kompressor (203.747)	145	M 111.981		03/01-05/02	SK20PR-L9	3307	0.9	-	-	IK20TT	IK20TT	4
C 320 (203.764)	160	M 112.946		09/02-02/08	PK16PR-L11	3275	1.1	-	-	IK16TT	IK16TT	6
C 350 (203.756)	200	M 272.960		01/05-02/08	SXU22HDR8	3441	0.8	-	-	VXUH22	6	
CITAN (415) (12-)												
108 CDI (415.601, 415.603)	55	OM 607.951		11/12-	DG-609		4.4V				4	
108 CDI (415.703)	55	OM 607.951		11/12-	DG-609		4.4V				4	
109 CDI	66	OM 607.951		11/12-	DG-609		4.4V				4	
109 CDI (415.601, 415.603, 415.605)	66	OM 607.951		11/12-	DG-609		4.4V				4	
109 CDI (415.703)	66	OM 607.951		11/12-	DG-609		4.4V				4	
111 CDI (415.601, 415.603, 415.605)	81	OM 607.951		06/13-	DG-609		4.4V				4	
111 CDI (415.603, 415.605)	81	OM 607.951		06/13-	DG-609		4.4V				4	
111 CDI (415.703)	81	OM 607.951		06/13-	DG-609		4.4V				4	
CLA Coupe (C117) (13-)												
CLA 180 CDI (117.312)	80	OM 607.951		10/13-	DG-609		4.4V				4	
CLC (CL203) (08-11)												
CLC 160 (203.731)	95	M 271.911		02/09-06/11	VXUH22	5611	0.9	-	-	VXUH22	4	
CLC 180 Kompressor (203.746)	105	M 271.946		05/08-06/11	VKH20	5618	1.1	-	-	IKH20TT	IKH20TT	4
CLC 200 CDI (203.707)	90	OM 646.962		05/08-06/11	DG-117		11.5V				4	
CLC 200 Kompressor (203.741)	135	M 271.957	Ch: 30853900>	05/08-06/11	VXUH22	5611	0.9	-	-	VXUH22	4	

	KW								QTY		
MERCEDES-BENZ <i>continued</i>											
CLC (CL203) (08-11) <i>continued</i>											
CLC 220 CDI (203.708)	110	OM 646.963		05/08-06/11	DG-117		11.5V		4		
CLC 230 (203.752)	150	M 272.920		05/08-06/11	SXU22HDR8	3441	0.8	-	VXUH22	6	
CLC 350 (203.756)	200	M 272.960		05/08-06/11	SXU22HDR8	3441	0.8	-	VXUH22	6	
CLK (208) (97-02)											
5.4	260	M 113.984		10/98-07/02	PK16PR11	3264	1.1	K16TT	IK16TT	IK16TT	16
55 AMG (208.374)	255	M 113.981; M 113.984		08/99-06/02	PK16PR11	3264	1.1	K16TT	IK16TT	IK16TT	16
55 AMG (208.474)	255	M 113.981; M 113.984		01/00-03/02	PK16PR11	3264	1.1	K16TT	IK16TT	IK16TT	16
200 (208.335)	100	M 111.945		06/97-06/02	K20TXR	5063	1.0	K20TT	IK20TT	IK20TT	4
200 (208.435)	100	M 111.941; M 111.945		03/98-03/02	K20TXR	5063	1.0	K20TT	IK20TT	IK20TT	4
200 Kompressor (208.344)	120	M 111.956		06/00-06/02	VK20	5604	1.1	-	IK20TT	IK20TT	4
200 Kompressor (208.345)	141	M 111.944		06/97-06/00	K20PBR-S10	5061	1.0	K20TT	IK20TT	IK20TT	4
200 Kompressor (208.444)	120	M 111.956		06/00-03/02	VK20Y	5620	0.8	-	-	VK20Y	4
200 Kompressor (208.445)	141	M 111.944		03/98-06/00	K20PBR-S10	5061	1.0	K20TT	IK20TT	IK20TT	4
230 Kompressor (208.347)	142	M 111.973; M 111.975		06/97-06/00	K20PBR-S10	5061	1.0	K20TT	IK20TT	IK20TT	4
230 Kompressor (208.348)	145	M 111.982		06/00-06/02	VK20	5604	1.1	-	IK20TT	IK20TT	4
230 Kompressor (208.447)	142	M 111.973; M 111.975		03/98-06/00	K20PBR-S10	5061	1.0	K20TT	IK20TT	IK20TT	4
230 Kompressor (208.448)	145	M 111.982		06/00-03/02	VK20Y	5620	0.8	-	-	VK20Y	4
320 (208.365)	160	M 112.940		06/97-06/02	PK16PR-L11	3275	1.1	-	IK16TT	IK16TT	12
320 (208.465)	160	M 112.940		03/98-03/02	PK16PR-L11	3275	1.1	-	IK16TT	IK16TT	12
430 (208.370)	205	M 113.943		07/98-06/02	PK16PR-L11	3275	1.1	-	IK16TT	IK16TT	16
430 (208.470)	205	M 113.943		09/98-03/02	PK16PR-L11	3275	1.1	-	IK16TT	IK16TT	16
CLK (209) (02-10)											
55 AMG (209.376)	270	M 113.987		09/02-05/09	PK16PR-L11	3275	1.1	-	IK16TT	IK16TT	16
63 AMG (209.377)	354/373	M 156.982		04/06-05/09	VFXEH22	5646	1.1	-	IXEH22TT	IXEH22TT	8
200 CGI (209.343)	125	M 271.942		07/03-05/09	VKH20	5618	1.1	-	IKH20TT	IKH20TT	4
200 Kompressor (209.341)	135	M 271.955	Eng: 30853900>	10/06-05/09	VXUH22	5611	0.9	-	-	VXUH22	4
200 Kompressor (209.342)	120	M 271.940		09/02-05/09	VKH20	5618	1.1	-	IKH20TT	IKH20TT	4
220 CDI (209.308)	110	OM 646.966		01/05-05/09	DG-117		11.5V				4
240 (209.361)	120/125	M 112.912		06/02-05/09	PK16PR-L11	3275	1.1	-	IK16TT	IK16TT	12
270 CDI (209.316)	120/125	OM612.967		10/02-05/05	DG-117		11.5V				5
280 (209.354)	170	M 272.940		01/05-05/09	SXU22HDR8	3441	0.8	-	-	VXUH22	6
320 (209.365)	160	M 112.955		06/02-05/09	PK16PR-L11	3275	1.1	-	IK16TT	IK16TT	12
320 CDI (209.320)	165	642.91		01/05-05/09	DG-194		4.4V				6
350 (209.356)	200	M 272.960		01/05-05/09	SXU22HDR8	3441	0.8	-	-	VXUH22	6
500 (209.372)	285	M 273.965		06/06-05/09	SXU22HDR8	3441	0.8	-	-	VXUH22	8
500 (209.375)	225	M 113.968		06/02-05/09	PK16PR-L11	3275	1.1	-	IK16TT	IK16TT	16
CLK 55 AMG (209.476)	270	M 113.987		02/03-03/10	SK20PR-L9	3307	0.9	-	IK20TT	IK20TT	16
CLK 63 AMG (209.477)	354	M 156.982		04/06-03/10	VFXEH22	5646	1.1	-	IXEH22TT	IXEH22TT	8
CLK 200 Kompressor (209.441)	135	M 271.955	Eng: 30853900>	10/06-03/10	VXUH22	5611	0.9	-	-	VXUH22	4
CLK 200 Kompressor (209.442)	120	M 271.940		02/03-11/05	VKH20	5618	1.1	-	IKH20TT	IKH20TT	4
CLK 240 (209.461)	125	M 112.912		02/03-03/10	PK16PR-L11	3275	1.1	-	IK16TT	IK16TT	12
CLK 280 (209.454)	170	M 272.940		01/05-03/10	SXU22HDR8	3441	0.8	-	-	VXUH22	6
CLK 320 (209.465)	160	M 112.955		02/03-03/10	PK16PR-L11	3275	1.1	-	IK16TT	IK16TT	12
CLK 320 CDI (209.420)	165	642.91		03/05-06/09	DG-194		4.4V				6
CLK 350 (209.456)	200	M 272.960		01/05-03/10	SXU22HDR8	3441	0.8	-	-	VXUH22	6
CLK 500 (209.472)	285	M 273.967		06/06-03/10	SXU22HDR8	3441	0.8	-	-	VXUH22	8
CLK 500 (209.475)	225	M 113.968		02/03-03/10	PK16PR-L11	3275	1.1	-	IK16TT	IK16TT	16
CLK AMG DTM	428	M 113.994		06/04-03/10	SK20PR-L9	3307	0.9	-	IK20TT	IK20TT	8
CLS (218) (11-)											
CLS 63 AMG (218.374)	386/410	M 157.981		01/11-	VFXEH22	5646	1.1	-	IXEH22TT	IXEH22TT	8
CLS 500 (218.373)	300	M 278.922		02/11-	VXUH22	5611	0.9	-	-	VXUH22	8
CLS (C219) (04-10)											
CLS 55 AMG (219.376)	350	M 113.990		01/05-01/08	VKH20	5618	1.1	-	IKH20TT	IKH20TT	8
CLS 63 AMG (219.377)	378	M 156.983		04/06-12/10	VFXEH22	5646	1.1	-	IXEH22TT	IXEH22TT	8
CLS 280 (219.354)	170	M 272.943		07/08-06/09	SXU22HDR8	3441	0.8	-	-	VXUH22	6
CLS 300 (219.354)	170	M 272.943		04/09-12/10	SXU22HDR8	3441	0.8	-	-	VXUH22	6
CLS 320 CDI	155	642.920(224)		01/05-12/10	DG-194		4.4V				6
CLS 320 CDI (219.322)	165	642.920(224)		01/05-12/10	DG-194		4.4V				6
CLS 350 (219.356)	200	M 272.964		10/04-01/08	SXU22HDR8	3441	0.8	-	-	VXUH22	6

	KW					Standard			Twin Tip				QTY	
MERCEDES-BENZ <i>continued</i>														
CLS (C219) (04-10) <i>continued</i>														
CLS 350 (219.357)	215	M 272.985		04/06-12/10	VXUH22I	5656	0.9	-	-	VXUH22I			6	
CLS 350 CDI (219.322)	165	642.920(224)		04/09-12/10	DG-194		4.4V						6	
CLS 350 CGI (219.357)	215	M 272.985		04/09-12/10	VXUH22I	5656	0.9	-	-	VXUH22I			6	
CLS 500 (219.372)	285	M 273.960		04/06-12/10	SXU22HDR8	3441	0.8	-	-	VXUH22			8	
CLS 500 (219.375)	225	M 113.967		10/04-01/08	PK16PR-L11	3275	1.1	-		IK16TT	IK16TT		16	
COUPE (C123) (77-85)														
230 C (123.043)	80	M 115.954		05/77-04/80	W20EP-U	3043	0.8	W20TT	IW20TT	IW20TT			4	
230 CE (123.243)	100	M 102.980		04/80-12/85	T20EP-U	5031	0.8	T20TT	IT20TT	IT20TT			4	
280 C (123.050)	115	M 110.923		03/77-03/80	W20PR-U	5046	0.7	-	-	-			6	
280 CE	130/ 136	M 110.988		03/77-11/85	W20PR-U	5046	0.7	-	-	-			6	
300 C Turbo-D (123.153)	92	OM 617.952		09/81-07/85	DG-001		11V						5	
COUPE (C124) (87-93)														
220 CE (124.042)	110	M 111.960		10/92-05/93	Q20P-U	3125	0.8	Q20TT	IQ20TT	IQ20TT			4	
230 CE (124.043)	97	M 102.982		03/87-12/92	T20EP-U	5031	0.8	T20TT	IT20TT	IT20TT			4	
230 CE (124.043) CAT	97	M 102.982		06/89-12/92	T20EP-U	5031	0.8	T20TT	IT20TT	IT20TT			4	
300 CE	138	M 103.983		03/87-12/89	T20EP-U	5031	0.8	T20TT	IT20TT	IT20TT			6	
300 CE (124.050)	132	M 103.983		03/87-05/93	T20EP-U	5031	0.8	T20TT	IT20TT	IT20TT			6	
300 CE-24 (124.051)	162	M 104.980		09/89-12/92	Q20P-U	3125	0.8	Q20TT	IQ20TT	IQ20TT			6	
320 CE (124.052)	162	M 104.992		10/92-05/93	Q20P-U	3125	0.8	Q20TT	IQ20TT	IQ20TT			6	
E-CLASS (124) (92-96)														
E 36 AMG	200	M 104.992 (AMG 3.6)		07/94-01/95	IQ20	5302	1.1	-		IQ20TT	IQ20TT		6	
E 200 (124.019)	100	M 111.940		06/93-06/95	Q20P-U	3125	0.8	Q20TT	IQ20TT	IQ20TT			4	
E 200 D (124.120)	55	OM 601.912		06/93-06/95	DG-010		11.5V						4	
E 200 D (124.120)	55	OM 601.912		06/93-06/95	DG-106		11.5V						4	
E 200 T (124.079)	100	M 111.940		06/93-06/96	Q20P-U	3125	0.8	Q20TT	IQ20TT	IQ20TT			4	
E 220 (124.022)	110	M 111.960		06/93-06/95	K16PR-U11	3130	1.1	K16TT	IK16TT	IK16TT			4	
E 220 T (124.082)	110	M 111.960		06/93-06/96	Q20R-U	3140	0.8	Q20TT	IQ20TT	IQ20TT			4	
E 250 D (124.126, 124.129)	83	OM 605.911		07/93-06/95	DG-119		11.5V						5	
E 250 D (124.126, 124.129)	83	OM 605.911	With Immobilizer	07/93-06/95	DG-106		11.5V						5	
E 250 TD (124.186)	83	OM 605.911		06/93-06/96	DG-119		11.5V						5	
E 250 TD (124.186)	83	OM 605.911	With Immobilizer	06/93-06/96	DG-106		11.5V						5	
E 250 Turbo D	93	OM 602.962		06/93-06/96	DG-010		11.5V						5	
E 250 Turbo-D (124.128)	93	OM 602.962		06/93-06/95	DG-010		11.5V						5	
E 280 (124.028)	145	M 104.942		06/93-06/95	Q20PR-U	3007	0.8	Q20TT	IQ20TT	IQ20TT			6	
E 280 (124.029)	142	M 104.942		06/93-06/95	Q20PR-U	3007	0.8	Q20TT	IQ20TT	IQ20TT			6	
E 280 T (124.088)	142	M 104.942		06/93-06/96	Q20PR-U	3007	0.8	Q20TT	IQ20TT	IQ20TT			6	
E 280 T (124.088)	145	M 104.942		06/93-06/96	Q20PR-U	3007	0.8	Q20TT	IQ20TT	IQ20TT			6	
E 300 4-matic (124.230)	132	M 103.985		06/93-06/95	T20EP-U	5031	0.8	T20TT	IT20TT	IT20TT			6	
E 300 D (124.131)	100	OM 606.910		07/93-06/95	DG-119		11.5V						6	
E 300 D (124.131)	100	OM 606.910	With Immobilizer	07/93-06/95	DG-106		11.5V						6	
E 300 T 4-matic (124.290)	132	M 103.985		06/93-06/96	T20EP-U	5031	0.8	T20TT	IT20TT	IT20TT			6	
E 300 T Turbo-D (124.193)	108	OM 603.960		06/93-06/96	DG-010		11.5V						6	
E 300 T Turbo-D 4-matic (124.393)	108	OM 603.963		06/93-06/96	DG-010		11.5V						6	
E 300 TD (124.191)	100	OM 606.910		06/93-06/96	DG-119		11.5V						6	
E 300 TD (124.191)	100	OM 606.910	With Immobilizer	06/93-06/96	DG-106		11.5V						6	
E 300 Turbo-D (124.133)	108	OM 603.960		06/93-06/95	DG-010		11.5V						6	
E 300 Turbo-D 4-matic (124.333)	108	OM 603.963		06/93-06/95	DG-010		11.5V						6	
E 320 (124.032)	162	M 104.992		06/93-06/95	Q20PR-U	3007	0.8	Q20TT	IQ20TT	IQ20TT			6	
E 320 T (124.092)	162	M 104.992		06/93-06/96	Q20P-U	3125	0.8	Q20TT	IQ20TT	IQ20TT			6	
E 420 (124.034)	205	M 119.975		06/93-06/95	Q20P-U	3125	0.8	Q20TT	IQ20TT	IQ20TT			8	
E 500 (124.036)	235	M 119.974		06/93-06/95	Q20P-U	3125	0.8	Q20TT	IQ20TT	IQ20TT			8	
E-CLASS (210) (95-03)														
E 50 AMG (210.072)	255	M 119.985 (AMG 5.0)		02/96-08/97	K20TXR	5063	1.0	K20TT	IK20TT	IK20TT			8	
E 55 AMG (210.074)	260	M 113.980		08/97-03/02	PK16PR-L11	3275	1.1	-		IK16TT	IK16TT		16	
E 55 AMG 4-matic (210.074)	260	M 113.980		03/01-03/02	PK16PR-L11	3275	1.1	-		IK16TT	IK16TT		16	
E 55 T AMG (210.274)	260	M 113.980		08/97-03/03	PK16PR-L11	3275	1.1	-		IK16TT	IK16TT		16	
E 55 T AMG 4-matic (210.283)	260	M 113.980		03/01-03/03	PK16PR-L11	3275	1.1	-		IK16TT	IK16TT		16	
E 200 (210.035)	100	M 111.942		06/95-08/00	K20PBR-S10	5061	1.0	K20TT	IK20TT	IK20TT			4	
E 200 CDI (210.007)	75/85	OM 611.961		06/98-03/02	DG-117		11.5V						4	
E 200 D (210.003)	65	OM 604.917		01/96-03/02	DG-106		11.5V						4	









	KW					Standard			Twin Tip			QTY
MERCEDES-BENZ <i>continued</i>												
E-CLASS (210) (95-03) <i>continued</i>												
E 200 Kompressor (210.045)	137	M 111.947		06/97-03/02	K20PBR-S10	5061	1.0		K20TT	IK20TT	IK20TT	4
E 200 Kompressor (210.048)	120	M 111.957		08/00-03/02	VK20	5604	1.1		-	IK20TT	IK20TT	4
E 200 T (210.235)	100	M 111.942		06/96-08/00	K20PBR-S10	5061	1.0		K20TT	IK20TT	IK20TT	4
E 200 T Kompressor (210.245)	137	M 111.947		06/97-03/03	K20PBR-S10	5061	1.0		K20TT	IK20TT	IK20TT	4
E 200 T Kompressor (210.248)	120	M 111.957		08/00-03/03	SK20PR-L9	3307	0.9		-	IK20TT	IK20TT	4
E 220 CDI (210.006)	92/105	OM 611.961		06/98-03/02	DG-117		11.5V					4
E 220 D	55	OM 604.912		05/96-03/02	DG-106		11.5V					4
E 220 D (210.004)	70	OM 604.912	With Immobilizer	06/95-07/99	DG-106		11.5V					4
E 220 D (210.004)	70	OM 604.912	Without Immobilizer	06/95-07/99	DG-119		11.5V					4
E 220 T CDI (210.206)	92/105	OM 611.961		06/98-03/03	DG-117		11.5V					4
E 230 (210.037)	110	M 111.970		06/95-06/97	Q20P-U	3125	0.8		Q20TT	IQ20TT	IQ20TT	4
E 230 T (210.237)	110	M 111.970		06/96-06/97	Q20P-U	3125	0.8		Q20TT	IQ20TT	IQ20TT	4
E 240 (210.061)	125	M 112.911		06/97-08/00	PK16PR-L11	3275	1.1		-	IK16TT	IK16TT	12
E 240 (210.062)	125	M 112.914		08/00-03/02	PK16PR-L11	3275	1.1		-	IK16TT	IK16TT	12
E 240 T (210.261)	125	M 112.911		06/97-03/03	PK16PR-L11	3275	1.1		-	IK16TT	IK16TT	12
E 240 T (210.262)	125	M 112.914		08/00-03/03	PK16PR-L11	3275	1.1		-	IK16TT	IK16TT	12
E 250 D (210.010)	83	OM 605.912		06/95-07/99	DG-106		11.5V					5
E 250 T D (210.210)	83	OM 605.912		06/96-07/99	DG-106		11.5V					5
E 250 T Turbo-D (210.215)	110	OM 605.962		06/97-07/99	DG-106		11.5V					5
E 250 Turbo-D (210.015)	110	OM 605.962		06/97-07/99	DG-106		11.5V					5
E 270 CDI (210.016)	125	OM 612.961		07/99-03/02	DG-117		11.5V					5
E 270 T CDI (210.216)	125	OM 612.961		07/99-03/03	DG-117		11.5V					5
E 280 (210.053)	142	M 104.945		01/96-06/97	Q20P-U	3125	0.8		Q20TT	IQ20TT	IQ20TT	6
E 280 (210.063)	150	M 112.921		12/96-03/02	PK16PR-L11	3275	1.1		-	IK16TT	IK16TT	12
E 280 4-matic (210.081)	150	M 112.921		12/96-03/02	PK16PR-L11	3275	1.1		-	IK16TT	IK16TT	12
E 280 T (210.263)	150	M 112.921		12/96-03/03	PK16PR-L11	3275	1.1		-	IK16TT	IK16TT	12
E 280 T 4-matic (210.281)	150	M 112.921		12/96-03/03	PK16PR-L11	3275	1.1		-	IK16TT	IK16TT	12
E 290 T Turbo-D (210.217)	95	OM 602.982		06/96-07/99	DG-110		11.5V					5
E 290 T Turbo-D (210.217)	95	OM 602.982		06/96-07/99	DG-117		11.5V					5
E 290 Turbo-D (210.017)	95	OM 602.982		03/96-07/99	DG-110		11.5V					5
E 300 D (210.020)	100	OM 606.912	With Immobilizer	06/95-06/97	DG-106		11.5V					6
E 300 D (210.020)	100	OM 606.912	Without Immobilizer	06/95-06/97	DG-119		11.5V					6
E 300 T Turbo-D (210.225)	130	OM 606.962		12/96-07/99	DG-119		11.5V					6
E 300 T Turbo-D (210.225)	130	OM 606.962	With Immobilizer	12/96-07/99	DG-106		11.5V					6
E 300 Turbo-D (210.025)	130	OM 606.962		12/96-07/99	DG-119		11.5V					6
E 300 Turbo-D (210.025)	130	OM 606.962	With Immobilizer	12/96-07/99	DG-106		11.5V					6
E 320 (210.055)	162	M 104.995		06/95-06/97	Q20P-U	3125	0.8		Q20TT	IQ20TT	IQ20TT	6
E 320 (210.065)	165	M 112.941		06/97-03/02	PK16PR-L11	3275	1.1		-	IK16TT	IK16TT	12
E 320 4-matic (210.082)	165	M 112.941		06/97-03/02	PK16PR-L11	3275	1.1		-	IK16TT	IK16TT	12
E 320 CDI (210.026)	145	OM 613.961		07/99-03/02	DG-117		11.5V					6
E 320 T (210.265)	165	M 112.941		12/96-03/03	PK16PR-L11	3275	1.1		-	IK16TT	IK16TT	12
E 320 T 4-matic (210.282)	165	M 112.941		12/96-03/03	PK16PR-L11	3275	1.1		-	IK16TT	IK16TT	12
E 320 T CDI (210.226)	145	OM 613.961		07/99-03/03	DG-117		11.5V					6
E 420 (210.072)	205	M 119.985		01/96-06/97	K20PBR-S10	5061	1.0		K20TT	IK20TT	IK20TT	8
E 420 T (210.272)	205	M 119.985		06/96-06/97	Q20P-U	3125	0.8		Q20TT	IQ20TT	IQ20TT	8
E 430 (210.070)	205	M 113.940		06/97-03/02	PK16PR-L11	3275	1.1		-	IK16TT	IK16TT	16
E 430 4-matic (210.083)	205	M 113.940		05/99-03/02	PK16PR-L11	3275	1.1		-	IK16TT	IK16TT	16
E 430 T (210.270)	205	M 113.940		06/97-03/03	PK16PR11	3264	1.1		K16TT	IK16TT	IK16TT	16
E 430 T 4-matic (210.283)	205	M 113.940		05/99-03/03	PK16PR11	3264	1.1		K16TT	IK16TT	IK16TT	16
E-CLASS (211) (02-09)												
E 55 AMG Kompressor (211.076)	350	M 113.990		10/02-03/06	VKH20	5618	1.1		-	IKH20TT	IKH20TT	8
E 55 T AMG Kompressor (211.276)	350	M 113.990		07/03-03/06	VKH20	5618	1.1		-	IKH20TT	IKH20TT	8
E 63 AMG (211.077, 211.177)	378	M 156.983		03/06-12/08	VFXEH22	5646	1.1		-	IXEH22TT	IXEH22TT	8
E 63 AMG (211.277)	378	M 156.983		03/06-07/09	VFXEH22	5646	1.1		-	IXEH22TT	IXEH22TT	8
E 200 CDI (211.004)	75/90	OM 646.951		07/02-12/08	DG-117		11.5V					4
E 200 Kompressor (211.041)	135	M 271.956		04/06-12/08	VKH20	5618	1.1		-	IKH20TT	IKH20TT	4
E 200 Kompressor (211.042)	120	M 271.941		11/02-03/06	VKH20	5618	1.1		-	IKH20TT	IKH20TT	4







	KW				Standard 			Twin Tip 			QTY
MERCEDES-BENZ <i>continued</i>											
E-CLASS (211) (02-09) <i>continued</i>											
E 200 Kompressor (211.241)	135	M 271.956		04/06-07/09	VKH20	5618	1.1	-	IKH20TT	IKH20TT	4
E 200 NGT (211.041)	120	M 271.941		03/04-03/06	VKH20	5618	1.1	-	IKH20TT	IKH20TT	4
E 200 NGT (211.041)	120	M 271.941	Flexible fuel	04/06-12/08	VXUH22	5611	0.9	-	-	VXUH22	4
E 200 T Kompressor (211.242)	120	M 271.941		03/03-03/06	VKH20	5618	1.1	-	IKH20TT	IKH20TT	4
E 220 CDI (211.006)	100/110	OM 646.961		03/02-12/08	DG-117		11.5V				4
E 220 CDI (211.206)	100	OM 646.961		03/03-07/09	DG-117		11.5V				4
E 220 T CDI (211.206)	110	OM 646.961		03/03-07/09	DG-117		11.5V				4
E 230 (211.052)	150	M 272.922		09/07-12/08	SXU22HDR8	3441	0.8	-	-	VXUH22	6
E 240 (211.061)	130	M 112.913; M 112.917		03/02-05/05	PK16PR-L11	3275	1.1	-	IK16TT	IK16TT	12
E 240 4-matic (211.080)	130	M 112.917		03/03-06/05	PK16PR-L11	3275	1.1	-	IK16TT	IK16TT	6
E 240 T (211.261)	130	M 112.913		03/03-05/05	PK16PR-L11	3275	1.1	-	IK16TT	IK16TT	12
E 240 T 4-matic (211.280)	130	M 112.917		07/03-06/05	PK16PR-L11	3275	1.1	-	IK16TT	IK16TT	6
E 270 CDI (211.016)	130	OM 647.961		03/02-12/08	DG-117		11.5V				5
E 270 T CDI (211.216)	130	OM 647.961		03/03-07/09	DG-117		11.5V				5
E 280 (211.054)	170	M 272.943		03/05-12/08	SXU22HDR8	3441	0.8	-	-	VXUH22	6
E 280 4-matic (211.092)	170	M 272.943		01/06-12/08	SXU22HDR8	3441	0.8	-	-	VXUH22	6
E 280 CDI (211.020)	140	642.920(190) - E4		03/05-12/08	DG-194		4.4V				6
E 280 CDI (211.023)	130	OM 648.961		05/04-12/08	DG-117		11.5V				6
E 280 CDI 4-matic	140	642.921(190)		03/05-12/08	DG-194		4.4V				6
E 280 T (211.254)	170	M 272.943		03/05-07/09	SXU22HDR8	3441	0.8	-	-	VXUH22	6
E 280 T 4-matic (211.292)	170	M 272.943		03/05-07/09	SXU22HDR8	3441	0.8	-	-	VXUH22	6
E 280 T CDI (211.220)	140	642.920(190) - E4		03/05-07/09	DG-194		4.4V				6
E 280 T CDI (211.223)	130	OM 648.961		05/04-07/09	DG-117		11.5V				6
E 280 T CDI 4-matic (211.284)	140	642.921(190)		03/05-07/09	DG-194		4.4V				6
E 300 BLUETEC	155	642.920(190) - E4		09/07-12/08	DG-194		4.4V				6
E 320 (211.065)	165	M 112.949		03/02-03/06	PK16PR-L11	3275	1.1	-	IK16TT	IK16TT	12
E 320 4-matic (211.082)	165	M 112.954		03/03-03/06	PK16PR-L11	3275	1.1	-	IK16TT	IK16TT	12
E 320 CDI (211.022)	165	642.920(224)		03/05-12/08	DG-194		4.4V				6
E 320 CDI (211.026)	150	OM 648.961		11/02-12/08	DG-117		11.5V				6
E 320 CDI 4-matic	165	642.921(224)		03/05-12/08	DG-194		4.4V				6
E 320 T (211.265)	165	M 112.949		03/03-03/06	PK16PR-L11	3275	1.1	-	IK16TT	IK16TT	12
E 320 T 4-matic (211.282)	165	M 112.954		07/03-03/06	PK16PR-L11	3275	1.1	-	IK16TT	IK16TT	12
E 320 T CDI (211.222)	165	642.920(224)		03/05-07/09	DG-194		4.4V				6
E 320 T CDI (211.226)	150	OM 648.961		03/03-07/09	DG-117		11.5V				6
E 320 T CDI 4-matic (211.289)	165	642.921(224)		03/05-07/09	DG-194		4.4V				6
E 350 (211.056)	200	M 272.964		03/05-12/08	SXU22HDR8	3441	0.8	-	-	VXUH22	6
E 350 4-matic	205	M 272.972		08/04-08/06	SXU22HDR8	3441	0.8	-	-	VXUH22	6
E 350 4-matic (211.087)	200	M 272.972		03/05-12/08	SXU22HDR8	3441	0.8	-	-	VXUH22	6
E 350 CGI (211.057)	215	M 272.985		09/07-12/08	SXU22HDR8	3441	0.8	-	-	VXUH22	6
E 350 T (211.256)	200	M 272.964		03/05-07/09	SXU22HDR8	3441	0.8	-	-	VXUH22	6
E 350 T 4-matic (211.287)	200	M 272.972		03/05-07/09	SXU22HDR8	3441	0.8	-	-	VXUH22	6
E 400 CDI (211.028)	191	OM 628.961		02/03-12/08	DG-117		11.5V				8
E 420 CDI (211.029)	231	OM 629.910		01/06-12/08	DG-194		4.4V				8
E 500 (211.070)	225	M 113.967		03/02-03/06	PK16PR-L11	3275	1.1	-	IK16TT	IK16TT	16
E 500 (211.072)	285	M 273.960		04/06-12/08	VKH20	5618	1.1	-	IKH20TT	IKH20TT	8
E 500 4-matic (211.083)	225	M 113.969		10/03-03/06	PK16PR-L11	3275	1.1	-	IK16TT	IK16TT	16
E 500 4-matic (211.090)	285	M 273.962		04/06-12/08	VXUH22	5611	0.9	-	-	VXUH22	8
E 500 T (211.270)	225	M 113.967		10/03-03/06	PK16PR-L11	3275	1.1	-	IK16TT	IK16TT	16
E 500 T (211.272)	285	M 273.960		04/06-07/09	VKH20	5618	1.1	-	IKH20TT	IKH20TT	8
E 500 T 4-matic (211.283)	225	M 113.969		10/03-03/06	PK16PR-L11	3275	1.1	-	IK16TT	IK16TT	16
E 500 T 4-matic (211.290)	285	M 273.962		04/06-07/09	VFXEH22	5646	1.1	-	IXEH22TT	IXEH22TT	8
E-CLASS (212) (09-)											
E 63 AMG (212.077)	386	M 156.985		12/09-	SXU22HDR8	3441	0.8	-	-	VXUH22	8
E 63 AMG (212.277)	386	M 156.985		08/09-	SXU22HDR8	3441	0.8	-	-	VXUH22	8
E 200 CGI (212.048, 212.148)	135	M 271.820; M 271.860		08/09-	VXUH22	5611	0.9	-	-	VXUH22	4
E 200 CGI (212.248)	135	M 271.820; M 271.860		11/09-	VXUH22	5611	0.9	-	-	VXUH22	4
E 200 NGT (212.041)	120	M 271.958		03/11-	VXUH22	5611	0.9	-	-	VXUH22	4
E 250 CGI (212.047, 212.147)	150	M 271.860		01/09-	VXUH22	5611	0.9	-	-	VXUH22	4
E 250 CGI (212.247)	150	M 271.860		11/09-	VXUH22	5611	0.9	-	-	VXUH22	4
E 350 (212.256)	200	M 272.980		08/09-	SXU22HDR8	3441	0.8	-	-	VXUH22	6
E 350 4-matic (212.087)	200	M 272.977		01/09-08/11	SXU22HDR8	3441	0.8	-	-	VXUH22	6

	KW					Standard			Twin Tip			QTY
MERCEDES-BENZ <i>continued</i>												
E-CLASS (212) (09-) <i>continued</i>												
E 350 4-matic (212.287)	200	M 272.977		11/09-	SXU22HDR8	3441	0.8	-	-	VXUH22		6
E 350 CGI (212.057)	215	M 272.982; M 272.983		01/09-08/11	VXUH22I	5656	0.9	-	-	VXUH22I		6
E 350 CGI (212.257)	215	M 272.983		11/09-	VXUH22I	5656	0.9	-	-	VXUH22I		6
E 500 (212.072)	285	M 273.971		01/09-	SXU22HDR8	3441	0.8	-	-	VXUH22		8
E 500 (212.272)	285	M 273.971		11/09-	SXU22HDR8	3441	0.8	-	-	VXUH22		8
E 500 4-matic (212.090)	285	M 273.970		01/09-	SXU22HDR8	3441	0.8	-	-	VXUH22		8
E-CLASS Coupe / Convertible (124) (93-98)												
E 36 AMG (124.052)	195/200	M 104.992 (AMG 3.6)		06/93-06/97	IQ20	5302	1.1	-	-	IQ20TT	IQ20TT	6
E 36 AMG (124.066)	200	M 104.992 (AMG 3.6)		05/94-03/98	IQ20	5302	1.1	-	-	IQ20TT	IQ20TT	6
E 200 (124.040)	100	M 111.940		06/93-06/97	Q20P-U	3125	0.8	Q20TT	IQ20TT	IQ20TT		4
E 200 (124.060)	100	M 111.940		06/93-03/98	Q20P-U	3125	0.8	Q20TT	IQ20TT	IQ20TT		4
E 220 (124.042)	110	M 111.960		06/93-06/97	Q20P-U	3125	0.8	Q20TT	IQ20TT	IQ20TT		4
E 220 (124.062)	110	M 111.960		06/93-03/98	Q20P-U	3125	0.8	Q20TT	IQ20TT	IQ20TT		4
E 320 (124.052)	162	M 104.992		06/93-06/97	Q20PR-U	3007	0.8	Q20TT	IQ20TT	IQ20TT		6
E 320 (124.066)	162	M 104.992; M 104.995		06/93-03/98	Q20P-U	3125	0.8	Q20TT	IQ20TT	IQ20TT		6
E-CLASS Coupe / Convertible (A207) (09-)												
E 200 CGI (207.348)	135	M 271.820; M 271.860		01/10-	VXUH22	5611	0.9	-	-	VXUH22		4
E 200 CGI (207.448)	135	M 271.820; M 271.860		01/10-	VXUH22	5611	0.9	-	-	VXUH22		4
E 250 CGI (207.347)	150	M 271.860		01/09-	VXUH22	5611	0.9	-	-	VXUH22		4
E 250 CGI (207.447)	150	M 271.860		01/10-	VXUH22	5611	0.9	-	-	VXUH22		4
E 350 CGI (207.357)	215	M 272.982; M 272.984		01/09-	VXUH22I	5656	0.9	-	-	VXUH22I		6
E 350 CGI (207.457)	215	M 272.982; M 272.984		01/10-	SXU22HDR8	3441	0.8	-	-	VXUH22		6
E 500 (207.372)	285	M 273.966		01/09-	SXU22HDR8	3441	0.8	-	-	VXUH22		8
E 500 (207.472)	285	M 273.966		01/10-	SXU22HDR8	3441	0.8	-	-	VXUH22		8
G-CLASS (W460) (79-93)												
230 G (460.2)	66/75	M 115.973		03/79-07/93	W20EP-U	3043	0.8	W20TT	IW20TT	IW20TT		4
230 GE (460.2)	90/92	M 102.979; M 102.981; M 102.987; M 102.989		04/82-08/92	T20EP-U	5031	0.8	T20TT	IT20TT	IT20TT		4
240 GD (460.3)	53	OM 616.936		08/80-08/87	DG-001		11V					4
250 GD (460.3)	62	OM 602.930		10/87-01/89	DG-001		11V					5
250 GD (460.3)	62/68	OM 602.930		12/88-12/92	DG-010		11.5V					5
280 GE (460.2)	110/115	M 110.994		11/79-08/89	W20PR-U	5046	0.7	-	-	-		6
300 GD (460.3)	65	OM 617.931		12/79-12/91	DG-001		11V					5
300 GD (460.3)	65	OM 617.931		12/79-12/91	DG-010		11.5V					5
300 GD (460.3)	83	OM 603.912		03/79-07/93	DG-010		11.5V					6
G-CLASS (W461) (90-)												
230 GE (461)	92	M 102.996; M 102.997		06/93-	T20EP-U	5031	0.8	T20TT	IT20TT	IT20TT		4
230 GE (461.238, 461.239)	90	M 102.979		02/93-07/96	T20EP-U	5031	0.8	T20TT	IT20TT	IT20TT		4
250 GD (461)	68	OM 602.939		02/90-	DG-010		11.5V					5
290 GD/G 290 D (461.337, 461.338)	70	OM 602.942		04/92-	DG-010		11.5V					5
G 290 TD (461.335, 461.336)	88	OM 602.983		07/97-	DG-010		11.5V					5
G-CLASS (W463) (89-)												
200 GE (463.200)	80	M 102.965		01/90-07/93	T20EP-U	5031	0.8	T20TT	IT20TT	IT20TT		4
230 GE (463.204)	93	M 102.989		06/90-02/93	T20EP-U	5031	0.8	T20TT	IT20TT	IT20TT		4
230 GE (463.224, 463.225)	93	M 102.989		06/90-06/93	T20EP-U	5031	0.8	T20TT	IT20TT	IT20TT		4
250 GD (463.324, 463.325)	69	OM 602.931		06/90-	DG-010		11.5V					5
300 GD (463.307)	83	OM 603.931		12/90-09/97	DG-010		11.5V					6
300 GD (463.327, 463.328)	83	OM 603.931		09/89-	DG-010		11.5V					6
300 GE (463.207)	125	M 103.987		09/89-09/97	T20EP-U	5031	0.8	T20TT	IT20TT	IT20TT		6
300 GE (463.227, 463.228)	125/128	M 103.987		06/90-	T20EP-U	5031	0.8	T20TT	IT20TT	IT20TT		6
350 G Turbo-D (463.300)	100	OM 603.972		09/91-09/97	DG-010		11.5V					6
350 Turbo GD (463.320, 463.321)	100	OM 603.972		09/91-	DG-010		11.5V					6
G 55 AMG (463.270, 463.271)	350	M 113.993		06/04-07/06	VKH20Y	5639	0.8	-	-	VKH20Y		8
G 270 CDI (463.322, 463.323)	115	OM 612.965		10/01-	DG-117		11.5V					5

Spark & Glow Plugs











Application Tables







	KW								QTY
MERCEDES-BENZ <i>continued</i>									
G-CLASS (W463) (89-) <i>continued</i>									
G 300 TD (463.308)	130	OM 606.964		09/96-	DG-106		11.5V		6
G 300 TD (463.330, 463.331)	130	OM 606.964		08/96-	DG-106		11.5V		6
G 320 (463.209)	158	M 112.945		11/97-	PK16PR11	3264	1.1	K16TT IK16TT IK16TT	6
G 320 (463.230, 463.231)	155	M 104.996		09/94-12/97	Q20P-U	3125	0.8	Q20TT IQ20TT IQ20TT	6
G 320 (463.232, 463.233, 463.244, 463.245)	158	M 112.945		07/97-	PK16PR11	3264	1.1	K16TT IK16TT IK16TT	6
G 400 CDI (463.309)	184	OM 628.962		12/00-	DG-117		11.5V		8
G 400 CDI (463.332, 463.333)	184	OM 628.962		12/00-	DG-117		11.5V		8
G 500 (463)	218	M 113.962		04/98-	PK16PR11	3264	1.1	K16TT IK16TT IK16TT	8
G 500 (463.247, 463.248, 463.249, 463.240, 463.421)	218	M 113.962		04/98-	PK16PR11	3264	1.1	K16TT IK16TT IK16TT	8
G 500 E (463.228)	177	M 117.965		09/93-	W20EP-U	3043	0.8	W20TT IW20TT IW20TT	8
GLA (X156) (13-)									
GLA 180 CDI (156.912)	80	OM 607.951		07/14-	DG-609		4.4V		4
GL-CLASS (X164) (06-)									
GL 320 CDI 4-matic (164.822)	165	642.940(224)		09/06-05/09	DG-194		4.4V		6
GL 350 CDI 4-matic (164.822)	165	642.940(224)		05/09-	DG-194		4.4V		6
GL 420 CDI 4-matic (164.828)	225	629.912(306)		09/06-05/09	DG-194		4.4V		8
GL 450 4-matic (164.871)	250	M 273.923		09/06-	SXU22HDR8	3441	0.8	- - VXUH22	8
GL 450 CDI 4-matic (164.828)	225	629.912(306)		05/09-	DG-194		4.4V		8
GL 500 4-matic (164.886)	285	M 273.963		09/06-	SXU22HDR8	3441	0.8	- - VXUH22	8
GLK (X204) (08-)									
200 CDI (204.901)	105	OM 651.913		07/10-06/12	DG-194		4.4V		4
220 CDI (204.902)	125	OM 651.916		12/08-06/12	DG-194		4.4V		4
280 4-matic (204.981)	170	M 272.948		06/08-06/09	SXU22HDR8	3441	0.8	- - VXUH22	6
300 4-matic (204.981)	170	M 272.948		07/09-04/11	SXU22HDR8	3441	0.8	- - VXUH22	6
320 CDI 4-matic (204.983)	165	OM 642.961		06/08-04/09	DG-194		4.4V		6
350 (204.956)	200	M 272.991		04/09-06/11	SXU22HDR8	3441	0.8	- - VXUH22	6
350 4-matic (204.987)	200	M 272.971		06/08-04/11	SXU22HDR8	3441	0.8	- - VXUH22	6
KOMBI (S123) (77-85)									
200 T	80	M 102.920		11/80-11/85	T20EP-U	5031	0.8	T20TT IT20TT IT20TT	4
200 T (123.280)	74	M 102.939		11/80-11/85	T20EP-U	5031	0.8	T20TT IT20TT IT20TT	4
230 T (123.083)	80	M 115.954		09/77-03/80	W20EP-U	3043	0.8	W20TT IW20TT IW20TT	4
230 TE (123.283)	100	M 102.980		04/80-11/85	T20EP-U	5031	0.8	T20TT IT20TT IT20TT	4
240 T D (123.183)	53	OM 616.912		08/80-12/85	DG-001		11V		4
250 T (123.086)	95	M 123.921		05/78-10/79	W20EP-U	3043	0.8	W20TT IW20TT IW20TT	6
280 TE (123.093)	136	M 110.988		09/77-11/85	W20EP-U	3043	0.8	W20TT IW20TT IW20TT	6
300 T D (123.190)	59/65	OM 617.912		09/77-11/85	DG-001		11V		5
300 T Turbo-D (123.193)	92	OM 617.952		10/80-11/85	DG-001		11V		5
KOMBI (S124) (85-93)									
200 E	77	M 102.922		11/92-05/93	T20EP-U	5031	0.8	T20TT IT20TT IT20TT	4
200 T (124.080)	77/80	M 102.922		09/85-05/90	T20EP-U	5031	0.8	T20TT IT20TT IT20TT	4
200 T D (124.180)	53	OM 601.912		09/85-01/89	DG-001		11V		4
200 T D (124.180)	53/55	OM 601.912		02/89-08/91	DG-010		11.5V		4
200 TE (124.079)	100	M 111.940		05/86-06/93	Q20P-U	3125	0.8	Q20TT IQ20TT IQ20TT	4
200 TE (124.081)	87	M 102.963		09/88-08/92	T20EP-U	5031	0.8	T20TT IT20TT IT20TT	4
230 TE (124.083)	97/100	M 102.982		09/85-08/92	T20EP-U	5031	0.8	T20TT IT20TT IT20TT	4
230 TE (124.083) CAT	97	M 102.982		06/89-08/92	T20EP-U	5031	0.8	T20TT IT20TT IT20TT	4
250 T D (124.185)	66	OM 602.912		09/85-01/89	DG-001		11V		5
250 T D (124.185)	66/69	OM 602.912		01/89-06/93	DG-010		11.5V		5
250 TD Turbo (124.188)	93	OM 602.962		03/88-01/89	DG-001		11V		5
250 TD Turbo (124.188)	93	OM 602.962		02/89-07/93	DG-010		11.5V		5
300 T D (124.190)	80	OM 603.912		09/86-01/89	DG-001		11V		6
300 T D (124.190)	80/81/83	OM 603.912		01/89-06/93	DG-010		11.5V		6
300 T Turbo-D	105	OM 603.960; OM 603.963		09/86-01/89	DG-001		11V		6
300 T Turbo-D	105	OM 603.960; OM 603.963		09/86-01/89	DG-010		11.5V		6
300 T Turbo-D (124.193)	108	OM 603.960		01/89-06/93	DG-010		11.5V		6
300 T Turbo-D 4-matic (124.393)	105	OM 603.963		09/86-01/89	DG-001		11V		6
300 T Turbo-D 4-matic (124.393)	105/108	OM 603.960; OM 603.963		09/86-06/93	DG-010		11.5V		6

	KW					Standard			Twin Tip			QTY
MERCEDES-BENZ <i>continued</i>												
KOMBI (S124) (85-93) <i>continued</i>												
300 TE (124.090)	132/138	M 103.983		01/86-08/92	T20EP-U	5031	0.8		T20TT	IT20TT	IT20TT	6
300 TE 4-matic (124.290)	132/138	M 103.983; M 103.985		09/86-06/93	T20EP-U	5031	0.8		T20TT	IT20TT	IT20TT	6
300 TE-24 (124.091)	162	M 104.980		09/89-08/92	Q20P-U	3125	0.8		Q20TT	IQ20TT	IQ20TT	6
M-CLASS (W163) (98-05)												
ML 55 AMG (163.174)	255	M 113.981		02/00-06/05	PK16PR-L11	3275	1.1	-		IK16TT	IK16TT	16
ML 230 (163.136)	110	M 111.977		02/98-05/00	K20PBR-S10	5061	1.0		K20TT	IK20TT	IK20TT	4
ML 270 CDI (163.113)	120	OM 612.963		12/99-06/05	DG-117		11.5V					5
ML 320 (163.154)	160	M 112.942		02/98-08/02	PK16PR-L11	3275	1.1	-		IK16TT	IK16TT	12
ML 350 4-matic	173	M 112.970		02/03-06/05	PK16PR-L11	3275	1.1	-		IK16TT	IK16TT	12
ML 400 CDI (163.128)	184	OM 628.963		09/01-06/05	DG-117		11.5V					8
ML 430 (163.172)	200	M 113.942		02/98-05/01	PK16PR-L11	3275	1.1	-		IK16TT	IK16TT	8
ML 500 (163.175)	215	M 113.964; M 113.965		09/01-06/05	PK16PR-L11	3275	1.1	-		IK16TT	IK16TT	16
M-CLASS (W164) (05-)												
ML 63 AMG 4-matic (164.177)	375	M 156.980		01/06-	VFXEH22	5646	1.1	-		IXEH22TT	IXEH22TT	8
ML 280 CDI 4-matic (164.120)	140	OM 642.940		07/05-07/09	DG-194		4.4V					6
ML 300 CDI 4-matic (164.120)	140	OM 642.940		07/09-	DG-194		4.4V					6
ML 320 CDI 4-matic (164.122)	165	OM 642.940		07/05-07/09	DG-194		4.4V					6
ML 350 4-matic (164.186)	200			07/05-	SXU22HDR8	3441	0.8	-	-		VXUH22	6
ML 350 CDI 4-matic (164.122)	165	OM 642.940		07/09-	DG-194		4.4V					6
ML 420 CDI 4-matic (164.128)	225	OM 629.912		02/06-09/09	DG-194		4.4V					8
ML 450 CDI 4-matic (164.128)	225	OM 629.912		09/09-	DG-194		4.4V					6
ML 500 4-matic (164.172)	285	M 273.963		12/07-	SXU22HDR8	3441	0.8	-	-		VXUH22	8
ML 500 4-matic (164.175)	225	M 113.964		07/05-04/08	PK16PR-L11	3275	1.1	-		IK16TT	IK16TT	16
M-CLASS (W166) (11-)												
ML 350 4-matic (166.057)	225	M 276.955		06/11-	SXU22HDR8	3441	0.8	-	-		VXUH22	6
R-CLASS (251) (06-)												
R 63 AMG (251.077, 251.177)	375	M 156.980		02/06-	VFXEH22	5646	1.1	-		IXEH22TT	IXEH22TT	8
R 280 (251.054, 251.154)	170	M 272.945		04/08-05/10	SXU22HDR8	3441	0.8	-	-		VXUH22	6
R 280 4-matic (251.062)	170	M 272.945		05/07-05/10	SXU22HDR8	3441	0.8	-	-		VXUH22	6
R 280 CDI (251.121, 251.026, 251.126)	140	642.950(190) - E4		05/06-06/09	DG-194		4.4V					6
R 280 CDI 4-matic (251.020)	140	642.950(190) - E4		05/06-06/09	DG-194		4.4V					6
R 300 (251.054, 251.154)	170	M 272.945		07/09-	SXU22HDR8	3441	0.8	-	-		VXUH22	6
R 300 CDI (251.021, 251.121, 251.026, 251.126)	140	OM 642.870; OM 642.872; OM 642.950		07/09-	DG-194		4.4V					6
R 300 CDI 4-matic (251.020)	140	OM 642.950		07/09-	DG-194		4.4V					6
R 320 CDI 4-matic (251.022, 251.122)	165	642.950(224) - E4		01/06-06/09	DG-194		4.4V					6
R 350 (251.056, 251.156)	200	M 272.967		01/07-	SXU22HDR8	3441	0.8	-	-		VXUH22	6
R 350 4-matic (251.065, 251.165)	200	M 272.967		01/06-	SXU22HDR8	3441	0.8	-	-		VXUH22	6
R 350 CDI 4-matic (251.022, 251.122)	165	OM 642.950		07/09-	DG-194		4.4V					6
R 350 CDI 4-matic (251.023, 251.123)	195	OM 642.872		08/10-	DG-194		4.4V					6
R 350 CDI 4-matic (251.124, 251.125)	155	OM 642.870; OM 642.950		01/06-	DG-194		4.4V					6
R 500 4-matic (251.072, 251.172)	285	M 273.963		04/08-	SXU22HDR8	3441	0.8	-	-		VXUH22	8
R 500 4-matic (251.075, 251.175)	225	M 113.971		01/06-04/08	PK16PR-L11	3275	1.1	-		IK16TT	IK16TT	16
Saloon (W123) (76-85)												
200	74	M 102.939		06/80-11/85	T20EP-U	5031	0.8		T20TT	IT20TT	IT20TT	4
200 (123.020)	69	M 115.938; M 115.939		02/76-08/80	W20EP-U	3043	0.8		W20TT	IW20TT	IW20TT	4
200 (123.220)	80	M 102.920		06/80-11/85	T20EP-U	5031	0.8		T20TT	IT20TT	IT20TT	4
200 D	44	OM 615.940	Eng: 008446;220790 >	09/80-11/85	DG-001		11V					4
200 D (123.120)	40	OM 615.940	Eng: 008446;220790 >	07/76-02/79	DG-001		11V					4
230 (123.023)	80	M 115.954		02/76-03/81	W20EP-U	3043	0.8		W20TT	IW20TT	IW20TT	4





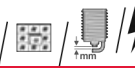





Spark & Glow Plugs

Application Tables

	KW										QTY
MERCEDES-BENZ <i>continued</i>											
Saloon (W123) (76-85) <i>continued</i>											
230 E (123.223)	100	M 102.980		04/80-12/85	T20EP-U	5031	0.8	T20TT	IT20TT	IT20TT	4
240 D (123.123)	53	OM 616.912		08/80-11/85	DG-001		11V				4
250 (123.026)	95	M 123.921		02/76-10/79	W20EP-U	3043	0.8	W20TT	IW20TT	IW20TT	6
280 (123.030)	115	M 110.923		02/76-08/81	W20EP-U	3043	0.8	W20TT	IW20TT	IW20TT	6
280 E (123.033)	136	M 110.984; M 110.988		02/76-11/85	W16EP-U	3018	0.8	W16TT	IW16TT	IW16TT	6
300 D (123.130)	65	OM 617.912		08/80-11/85	DG-001		11V				5
300 Turbo-D (123.133)	92	OM 617.952		08/81-07/85	DG-001		11V				5
Saloon (W124) (84-93)											
200	77	M 102.922		01/86-05/90	T20EP-U	5031	0.8	T20TT	IT20TT	IT20TT	4
200 (124.020)	75/80	M 102.922		12/85-05/90	T20EP-U	5031	0.8	T20TT	IT20TT	IT20TT	4
200 D (124.120)	53	OM 601.912		12/84-01/89	DG-001		11V				4
200 D (124.120)	53/55	OM 601.912		02/89-06/93	DG-010		11.5V				4
200 E	77	M 102.922		11/92-05/93	T20EP-U	5031	0.8	T20TT	IT20TT	IT20TT	4
200 E (124.019)	100	M 111.940		10/92-06/93	Q20P-U	3125	0.8	Q20TT	IQ20TT	IQ20TT	4
200 E (124.021)	87	M 102.963		09/88-08/92	T20EP-U	5031	0.8	T20TT	IT20TT	IT20TT	4
220 E (124.022)	110	M 111.960		10/92-06/93	Q20P-U	3125	0.8	Q20TT	IQ20TT	IQ20TT	4
230 E (124.023)	97/100	M 102.982		12/84-06/93	T20EP-U	5031	0.8	T20TT	IT20TT	IT20TT	4
230 E (124.023) CAT	97	M 102.982		06/89-06/93	T20EP-U	5031	0.8	T20TT	IT20TT	IT20TT	4
250 D (124.125)	66	OM 602.912		04/85-12/87	DG-001		11V				5
250 D (124.125)	66/69	OM 602.912		01/88-06/93	DG-010		11.5V				5
250 Turbo-D (124.128)	93	OM 602.962		09/88-06/93	DG-010		11.5V				5
260 E (124.026)	118/122	M 103.940		09/85-08/92	T20EP-U	5031	0.8	T20TT	IT20TT	IT20TT	6
260 E 4-matic (124.226)	118	M 103.943		09/86-08/92	T20EP-U	5031	0.8	T20TT	IT20TT	IT20TT	6
280 E (124.028)	145	M 104.942		10/92-06/93	Q20P-U	3125	0.8	Q20TT	IQ20TT	IQ20TT	6
300 D (124.130)	80	OM 603.912		12/84-01/89	DG-001		11V				6
300 D (124.130)	80/81/83	OM 603.912		02/89-06/93	DG-010		11.5V				6
300 D 4-matic (124.330)	80	OM 603.913		09/86-01/89	DG-001		11V				6
300 D 4-matic (124.330)	80/83	OM 603.913		02/89-06/93	DG-010		11.5V				6
300 E	138	M 103.980		01/85-12/85	Q20P-U	3125	0.8	Q20TT	IQ20TT	IQ20TT	6
300 E	138	M 103.983		06/85-08/92	T20EP-U	5031	0.8	T20TT	IT20TT	IT20TT	6
300 E (124.030)	132	M 103.983		08/85-08/92	T20EP-U	5031	0.8	T20TT	IT20TT	IT20TT	6
300 E 4-matic	138	M 103.983		09/86-02/92	T20EP-U	5031	0.8	T20TT	IT20TT	IT20TT	6
300 E 4-matic (124.230)	132	M 103.985		09/86-06/93	T20EP-U	5031	0.8	T20TT	IT20TT	IT20TT	6
300 E-24 (124.031)	162	M 104.980		09/88-08/92	Q20P-U	3125	0.8	Q20TT	IQ20TT	IQ20TT	6
300 Turbo-D (124.133)	105	OM 603.960; OM 603.963		09/86-09/88	DG-001		11V				6
300 Turbo-D (124.133)	108	OM 603.960		09/88-06/93	DG-010		11.5V				6
300 Turbo-D 4-matic (124.333)	105/108	OM 603.960; OM 603.963		09/86-01/89	DG-001		11V				6
300 Turbo-D 4-matic (124.333)	108	OM 603.963		02/89-06/93	DG-010		11.5V				6
400 E 4.2 (124.034)	205	M 119.975		10/92-06/93	Q20P-U	3125	0.8	Q20TT	IQ20TT	IQ20TT	8
500 E (124.036)	240	M 119.974		01/91-06/93	Q20P-U	3125	0.8	Q20TT	IQ20TT	IQ20TT	8
S-CLASS (W116) (72-80)											
280 SE,SEL (116.024)	130/136	M 110.983; M 110.985		08/72-07/80	W20EPR-U	3047	0.8	W20TT	IW20TT	IW20TT	6
350 SE,SEL (116.028, 116.029)	151	M 116.985		03/76-03/80	W20EPR-U	3047	0.8	W20TT	IW20TT	IW20TT	8
450 SE,SEL (116.032)	165	M 117.983; M 117.986		01/73-04/80	W20EP-U	3043	0.8	W20TT	IW20TT	IW20TT	8
S-CLASS (W126) (79-91)											
260 SE (126.020)	118/122	M 103.941		09/85-06/91	T20EP-U	5031	0.8	T20TT	IT20TT	IT20TT	6
280 S (126.021)	115	M 110.924; M 110.926		12/79-07/85	W20EP-U	3043	0.8	W20TT	IW20TT	IW20TT	6
280 SE,SEL (126.022, 126.023)	136	M 110.987; M 110.989		10/79-07/85	W20EP-U	3043	0.8	W20TT	IW20TT	IW20TT	6
300 SE,SEL (126.024, 126.025)	132/138	M 103.981		09/85-06/91	T20EP-U	5031	0.8	T20TT	IT20TT	IT20TT	6
380 SE,SEL (126.032)	150/160	M 116.961; M 116.963		09/80-08/86	W20EP-U	3043	0.8	W20TT	IW20TT	IW20TT	8
420 SE,SEL	165/170	M 116.965		10/85-06/91	W20EP-U	3043	0.8	W20TT	IW20TT	IW20TT	8
420 SE,SEL (126.034)	160	M 116.965		10/85-12/87	W20EP-U	3043	0.8	W20TT	IW20TT	IW20TT	8
500 SE,SEL	185/195	M 117.965		09/87-06/91	W20EP-U	3043	0.8	W20TT	IW20TT	IW20TT	8







	KW								QTY		
MERCEDES-BENZ <i>continued</i>											
S-CLASS (W126) (79-91) <i>continued</i>											
500 SE,SEL (126.036)	164/ 170/ 177/ 180	M 117.961; M 117.963; M 117.964; M 117.965		09/85-06/91	W20EP-U	3043	0.8	W20TT	IW20TT	IW20TT	8
500 SE,SEL CAT	185	M 117.965		06/89-06/91	W20EP-U	3043	0.8	W20TT	IW20TT	IW20TT	8
560 SE,SEL	205/ 220	M 117.968		10/85-06/91	W20EP-U	3043	0.8	W20TT	IW20TT	IW20TT	8
560 SE,SEL (126.038)	200	M 117.968		10/85-12/87	W20EP-U	3043	0.8	W20TT	IW20TT	IW20TT	8
560 SE,SEL (126.038, 126.039)	178	M 117.968		10/85-06/91	W20EP-U	3043	0.8	W20TT	IW20TT	IW20TT	8
S-CLASS (W140) (91-98)											
300 SE 2.8 (140.028)	145	M 104.944		01/93-10/98	Q20P-U	3125	0.8	Q20TT	IQ20TT	IQ20TT	6
300 SE,SEL/S320 (140.032, 140.033)	170	M 104.990; M 104.994		03/91-10/98	Q20P-U	3125	0.8	Q20TT	IQ20TT	IQ20TT	6
400 SE,SEL/S420 (140.042, 140.043)	210	M 119.971		02/91-10/98	Q20P-U	3125	0.8	Q20TT	IQ20TT	IQ20TT	8
500 SE,SEL (140.050, 140.051)	240	M 119.970		02/91-10/98	PK20PR11	3168	1.1	K20TT	IK20TT	IK20TT	8
600 SE,SEL (140.056, 140.057)	300	M 120.980; M 120.982		04/91-12/92	Q20P-U	3125	0.8	Q20TT	IQ20TT	IQ20TT	12
S 280 (140.028)	142	M 104.944		02/93-10/98	Q20P-U	3125	0.8	Q20TT	IQ20TT	IQ20TT	6
S 300 Turbo-D (140.135)	130	OM 606.961		05/96-10/98	DG-106		11.5V				6
S 350 Turbo-D (140.134)	110	OM 603.971		01/93-09/95	DG-010		11.5V				6
S 350 Turbo-D (140.134)	110	OM 603.971		10/95-10/98	DG-106		11.5V				6
S 420 (140.042)	205	M 119.971		01/93-10/98	Q20P-U	3125	0.8	Q20TT	IQ20TT	IQ20TT	8
S 500 (140.050, 140.051)	235	M 119.970; M 119.980		01/93-10/98	PK16PR11	3264	1.1	K16TT	IK16TT	IK16TT	8
S 600 (140.056, 140.057)	290	M 120.980; M 120.982		01/93-10/98	Q20P-U	3125	0.8	Q20TT	IQ20TT	IQ20TT	12
S-CLASS (W220) (98-05)											
S 55 AMG (220.073, 220.173)	265	M 113.986		04/99-08/05	PK16PR-L11	3275	1.1	-	IK16TT	IK16TT	16
S 55 AMG Kompressor (220.074, 220.174)	368	M 113.991		06/02-08/05	PK16PR-L11	3275	1.1	-	IK16TT	IK16TT	16
S 65 AMG (220.179)	450	M 275.980		03/04-08/05	VK20Y	5620	0.8	-	-	VK20Y	12
S 280 (220.063, 220.163)	150	M 112.922		10/98-08/05	PK16PR-L11	3275	1.1	-	IK16TT	IK16TT	12
S 320 (220.065, 220.165)	165	M 112.944		10/98-08/05	PK16PR-L11	3275	1.1	-	IK16TT	IK16TT	12
S 320 CDI (220.025, 220.125)	150	OM 648.960		09/02-08/05	DG-117		11.5V				6
S 320 CDI (220.026, 220.126)	145	OM 613.960		08/99-09/02	DG-117		11.5V				6
S 350 (220.067, 220.167)	180	M 112.972		09/02-08/05	PK16PR-L11	3275	1.1	-	IK16TT	IK16TT	12
S 350 4-matic (220.087, 220.187)	180	M 112.975		06/03-08/05	PK16PR-L11	3275	1.1	-	IK16TT	IK16TT	12
S 400 CDI (220.028, 220.128)	184/ 191	OM 628.960		06/00-08/05	DG-117		11.5V				8
S 430 (220.070, 220.170)	205	M 113.941		10/98-08/05	PK16PR-L11	3275	1.1	-	IK16TT	IK16TT	16
S 430 4-matic (220.083, 220.183)	205	M 113.948		09/02-08/05	PK16PR-L11	3275	1.1	-	IK16TT	IK16TT	16
S 500 (220.075, 220.175, 220.875)	225	M 113.960; M 113.966		10/98-08/05	PK16PR-L11	3275	1.1	-	IK16TT	IK16TT	16
S 500 4-matic (220.084, 220.184)	225	M 113.966		09/02-08/05	PK16PR-L11	3275	1.1	-	IK16TT	IK16TT	16
S 600 (220.176)	368	M 275.950		09/02-08/05	VK20Y	5620	0.8	-	-	VK20Y	12
S 600 (220.878, 220.178)	270	M 137.970		01/00-08/05	SK20PR-L9	3307	0.9	-	IK20TT	IK20TT	12
S-CLASS (W221) (05-)											
S 63 AMG (221.074, 221.174)	400	M 157.980		03/11-	VK20Y	5620	0.8	-	-	VK20Y	8
S 63 AMG (221.077, 221.177)	386	M 156.984		10/06-	VFXEH22	5646	1.1	-	IXEH22TT	IXEH22TT	8
S 65 AMG (221.179)	450/ 463	M 275.982		12/05-	VK20Y	5620	0.8	-	-	VK20Y	12
S 320 CDI (221.022, 221.122)	173	642.930		12/05-06/09	DG-194		4.4V				6
S 320 CDI 4-matic (221.080, 221.180)	173	642.932		10/06-06/09	DG-194		4.4V				6
S 350 (221.056, 221.156)	200	M 272.965		10/05-06/09	SXU22HDR8	3441	0.8	-	-	VXUH22	6
S 350 CGI (221.057, 221.157)	225	M 276.950		04/11-	SXU22HDR8	3441	0.8	-	-	VXUH22	6
S 400 Hybrid (221.095, 221.195)	205	M 272.974		01/09-	SXU22HDR8	3441	0.8	-	-	VXUH22	6
S 420 CDI / S 450 CDI (221.028, 221.128)	235	629.911		10/06-06/09	DG-194		4.4V				8
S 450 (221.070, 221.170)	250	M 273.922		12/05-06/09	SXU22HDR8	3441	0.8	-	-	VXUH22	8
S 450 4-matic (221.084, 221.184)	250	M 273.924		12/05-06/09	SXU22HDR8	3441	0.8	-	-	VXUH22	8
S 500 (221.071, 221.171)	285	M 273.961		10/05-06/09	SXU22HDR8	3441	0.8	-	-	VXUH22	8









KW	KW	KW	KW	KW	KW	Standard			Twin Tip			QTY
						Standard	Standard	Standard	Twin Tip	Twin Tip	Twin Tip	
MERCEDES-BENZ <i>continued</i>												
S-CLASS (W221) (05-) <i>continued</i>												
S 500 4-matic (221.086, 221.186)	285	M 273.961; M 273.968		10/05-06/09	SXU22HDR8	3441	0.8	-	-	VXUH22	8	
S 600 (221.176)	380	M 275.953		12/05-	VK20Y	5620	0.8	-	-	VK20Y	12	
S-CLASS Coupe (C126) (80-91)												
380 SEC (126.043)	150	M 116.963		10/81-07/85	W20EP-U	3043	0.8	W20TT	IW20TT	IW20TT	8	
420 SEC (126.046)	150/165	M 116.965		10/85-06/91	W20EP-U	3043	0.8	W20TT	IW20TT	IW20TT	8	
500 SEC (126.044)	164/170/180/185/195	M 117.963; M 117.965		09/85-06/91	W20EP-U	3043	0.8	W20TT	IW20TT	IW20TT	8	
500 SEC CAT	185	M 117.965		06/89-06/91	W20EP-U	3043	0.8	W20TT	IW20TT	IW20TT	8	
560 SEC (126.045)	200/205/220	M 117.968		10/85-12/89	W20EP-U	3043	0.8	W20TT	IW20TT	IW20TT	8	
S-CLASS Coupe (C140) (92-99)												
SEC/CL 420 (140.063)	205	M 119.971; M 119.981		10/94-02/99	Q20P-U	3125	0.8	Q20TT	IQ20TT	IQ20TT	8	
SEC/CL 500 (140.070)	235	M 119.970		10/92-02/99	Q20P-U	3125	0.8	Q20TT	IQ20TT	IQ20TT	8	
SEC/CL 600 (140.076)	290	M 120.980; M 120.982		09/92-02/99	Q20P-U	3125	0.8	Q20TT	IQ20TT	IQ20TT	12	
S-CLASS Coupe (C215) (99-06)												
CL 55 AMG (215.373)	265	M 113.986		10/99-03/06	PK16PR-L11	3275	1.1	-	IK16TT	IK16TT	16	
CL 55 AMG Kompressor (215.374)	368	M 113.991		06/02-03/06	VKH20	5618	1.1	-	IKH20TT	IKH20TT	8	
CL 65 AMG (215.379)	450	M 275.980		09/03-03/06	VK20Y	5620	0.8	-	-	VK20Y	12	
CL 500 (215.375)	225	M 113.960		03/99-03/06	PK16PR-L11	3275	1.1	-	IK16TT	IK16TT	16	
CL 600 (215.376)	368	M 275.950		09/02-03/06	VK20Y	5620	0.8	-	-	VK20Y	12	
CL 600 (215.378)	270	M 137.970		03/99-03/06	SK20PR-L9	3307	0.9	-	IK20TT	IK20TT	12	
S-CLASS Coupe (C216) (06-)												
CL 63 AMG (216.377)	386	M 156.984		10/06-	VFXEH22	5646	1.1	-	IXEH22TT	IXEH22TT	8	
CL 65 AMG (216.379)	450	M 275.982		10/06-	VXUH22	5611	0.9	-	-	VXUH22	12	
CL 500 (216.371)	285	M 273.961		06/06-	VFXEH22	5646	1.1	-	IXEH22TT	IXEH22TT	8	
CL 500 4-matic (216.386)	285	M 273.968		02/08-	SXU22HDR8	3441	0.8	-	-	VXUH22	8	
CL 600 (216.376)	380	M 275.953		05/06-	VFXEH22	5646	1.1	-	IXEH22TT	IXEH22TT	12	
SL (R107) (71-89)												
280 SL (107.042)	136	M 110.982; M 110.986; M 110.990		08/74-07/85	W20EPR-U	3047	0.8	W20TT	IW20TT	IW20TT	6	
300 SL (107.041)	132/138	M 103.982		09/85-08/89	T20EP-U	5031	0.8	T20TT	IT20TT	IT20TT	6	
350 SL (107.043)	143	M 116.982; M 116.984		05/71-02/80	W20EP-U	3043	0.8	W20TT	IW20TT	IW20TT	8	
380 SL (107.045)	160	M 116.960		09/80-08/81	W20EP-U	3043	0.8	W20TT	IW20TT	IW20TT	8	
420 SL (107.047)	160	M 116.964		01/86-08/89	W20EP-U	3043	0.8	W20TT	IW20TT	IW20TT	8	
450 SL (107.044)	160/165	M 117.982; M 117.985		10/72-10/80	W20EP-U	3043	0.8	W20TT	IW20TT	IW20TT	8	
500 SL (107.046)	170/177/180	M 117.960; M 117.964		05/80-08/89	W20EP-U	3043	0.8	W20TT	IW20TT	IW20TT	8	
SL (R129) (89-01)												
55 AMG	260	M 113.985		03/00-10/01	PK16PR11	3264	1.1	K16TT	IK16TT	IK16TT	8	
60 AMG (129.067)	280	M 122.981		05/97-10/01	Q20P-U	3125	0.8	Q20TT	IQ20TT	IQ20TT	8	
280 (129.058)	142	M 104.943		08/93-10/01	Q20P-U	3125	0.8	Q20TT	IQ20TT	IQ20TT	6	
280 (129.059)	150	M 112.923; M 112.925		05/98-10/01	PK16PR11	3264	1.1	K16TT	IK16TT	IK16TT	6	
300 SL (129.060)	140	M 103.984		03/89-08/93	T20EP-U	5031	0.8	T20TT	IT20TT	IT20TT	6	
300 SL-24 (129.061)	170	M 104.981		03/89-07/93	Q20P-U	3125	0.8	Q20TT	IQ20TT	IQ20TT	6	
320 (129.063)	170	M 104.991		09/93-10/01	Q20P-U	3125	0.8	Q20TT	IQ20TT	IQ20TT	6	
320 (129.064)	165	M 112.943		05/98-10/01	PK16PR11	3264	1.1	K16TT	IK16TT	IK16TT	6	
500 (129.067)	235	M 119.972; M 119.982		09/92-10/01	Q20P-U	3125	0.8	Q20TT	IQ20TT	IQ20TT	8	
500 SL (129.066)	240	M 119.960; M 119.972		09/89-08/92	Q20P-U	3125	0.8	Q20TT	IQ20TT	IQ20TT	8	
600 (129.076)	290	M 120.981; M 120.983		07/92-10/01	Q20P-U	3125	0.8	Q20TT	IQ20TT	IQ20TT	12	
SL (R230) (01-12)												
55 AMG	380	M 113.995		03/06-01/08	VKH20Y	5639	0.8	-	-	VKH20Y	8	
55 AMG (230.474)	350	M 113.992		10/01-06/02	VKH20	5618	1.1	-	IKH20TT	IKH20TT	8	
55 AMG Kompressor (230.474)	368	M 113.992		06/02-01/08	VKH20Y	5639	0.8	-	-	VKH20Y	8	
63 AMG (230.470)	386	M 156.981		03/08-01/12	VFXEH22	5646	1.1	-	IXEH22TT	IXEH22TT	8	
65 AMG (230.479)	450	M 275.981		03/04-01/12	VK20Y	5620	0.8	-	-	VK20Y	12	

	KW					Standard						QTY
MERCEDES-BENZ <i>continued</i>												
SL (R230) (01-12) <i>continued</i>												
280	170	M 272.949		03/08-01/12	SXU22HDR8	3441	0.8	-	-	VXUH22		6
300	170	M 272.949		04/09-01/12	SXU22HDR8	3441	0.8	-	-	VXUH22		6
350	200/ 232	M 272.966; M 272.968		03/06-01/12	SXU22HDR8	3441	0.8	-	-	VXUH22		6
350 (230.467)	180	M 112.973		03/03-10/05	PK16PR-L11	3275	1.1	-	IK16TT	IK16TT		6
500	285	M 273.965		03/06-01/12	SXU22HDR8	3441	0.8	-	-	VXUH22		8
500 (230.475)	225	M 113.963		10/01-10/05	PK16PR-L11	3275	1.1	-	IK16TT	IK16TT		8
600	380	M 275.954		03/06-01/08	SXU22HDR8	3441	0.8	-	-	VXUH22		12
600 (230.476)	368	M 275.951		04/03-10/05	VK20Y	5620	0.8	-	-	VK20Y		12
SL (W121) (55-63)												
190 SL	77			01/55-12/63	W22EPR-U	3088	0.8	W22TT	-	VW22		4
SLC (C107) (72-84)												
350 SLC (107.023)	143	M 116.982; M 116.984		03/76-02/80	W20EP-U	3043	0.8	W20TT	IW20TT	IW20TT		8
380 SLC (107.025)	160	M 116.960		07/80-08/81	W20EP-U	3043	0.8	W20TT	IW20TT	IW20TT		8
450 SLC (107.024)	160/ 165	M 117.982; M 117.985		01/73-08/79	W20EP-U	3043	0.8	W20TT	IW20TT	IW20TT		8
450 SLC 5.0 (107.026)	177	M 117.960		06/78-02/80	W20EP-U	3043	0.8	W20TT	IW20TT	IW20TT		8
SLK (R170) (96-04)												
32 AMG Kompressor (170.466)	260	M 112.960		03/01-04/04	SK20PR-L9	3307	0.9	-	IK20TT	IK20TT		6
200 (170.435)	100	M 111.946	Eng: 2090, 4775>	09/96-03/00	K20PBR-S10	5061	1.0	K20TT	IK20TT	IK20TT		4
200 Kompressor (170.444)	120	M 111.958		03/00-04/04	SK20PR-L9	3307	0.9	-	IK20TT	IK20TT		4
200 Kompressor (170.445)	141	M 111.943		10/96-03/00	K20PBR-S10	5061	1.0	K20TT	IK20TT	IK20TT		4
230 Kompressor (170.447)	142	M 111.973		09/96-03/00	K20PBR-S10	5061	1.0	K20TT	IK20TT	IK20TT		4
230 Kompressor (170.449)	145	M 111.983		03/00-04/04	SK20PR-L9	3307	0.9	-	IK20TT	IK20TT		4
320 (170.465)	160	M 112.947		03/00-04/04	PK16PR-L11	3275	1.1	-	IK16TT	IK16TT		12
SLK (R171) (04-11)												
55 AMG (171.473)	265	M 113.989		06/04-02/11	SK20PR-L9	3307	0.9	-	IK20TT	IK20TT		8
200 Kompressor (171.442)	120	M 271.944		03/04-12/07	VKH20Y	5639	0.8	-	-	VKH20Y		4
200 Kompressor (171.445)	135	M 271.954	Ch: 30853900>	01/08-02/11	VXUH22	5611	0.9	-	-	VXUH22		4
280 (171.454)	170	M 272.942		01/05-12/07	SXU22HDR8	3441	0.8	-	-	VXUH22		6
300 (171.454)	170	M 272.942		04/09-02/11	SXU22HDR8	3441	0.8	-	-	VXUH22		6
350 (171.456)	200	M 272.963		06/04-12/07	SXU22HDR8	3441	0.8	-	-	VXUH22		6
350 (171.458)	224	M 272.969		01/08-02/11	SXU22HDR8	3441	0.8	-	-	VXUH22		6
SLK (R172) (11-)												
200 (172.448)	135	M 271.860; M 271.861		02/11-	VXUH22	5611	0.9	-	-	VXUH22		4
250 (172.447)	150	M 271.860; M 271.861		02/11-	VXUH22	5611	0.9	-	-	VXUH22		4
SLR (R199) (04-)												
5.4	460/ 478	M 155.980		10/06-	VKH20	5618	1.1	-	IKH20TT	IKH20TT		16
5.4 (199.376)	460	M 155.980		04/04-	VKH20	5618	1.1	-	IKH20TT	IKH20TT		16
5.4 722 Edition	478	M 155.980		10/06-	VKH20	5618	1.1	-	IKH20TT	IKH20TT		16
SPRINTER 2-t (901, 902) (95-06)												
208 CDI	60	OM 611.987		04/00-05/06	DG-117		11.5V					4
208 D	58/60	OM 601.943		01/95-04/00	DG-010		11.5V					4
210 D	75	OM 602.980		01/97-04/00	DG-110		11.5V					5
211 CDI	80	OM 611.981		04/00-05/06	DG-117		11.5V					4
212 D	90	OM 602.980	Eng: >9849	02/95-04/00	DG-001		11V					5
212 D	90	OM 602.980	Eng: 9850>	02/95-04/00	DG-110		11.5V					5
213 CDI	95	OM 611.981		04/00-05/06	DG-117		11.5V					4
214	105	M 111.979		02/95-05/06	K20PBR-S10	5061	1.0	K20TT	IK20TT	IK20TT		4
214	105	M 111.979; M 111.984		02/95-05/06	PK20PR11	3168	1.1	K20TT	IK20TT	IK20TT		4
216 CDI	115	OM 612.981		04/00-05/06	DG-117		11.5V					5
SPRINTER 3,5 (906) (06-)												
309 CDI (906.131, 906.133, 906.135, 906.231, 906.233...)	65	OM 646.984	Alternative fitting+	06/06-	DG-117		11.5V					4
309 CDI (906.631, 906.633, 906.635, 906.637)	65	OM 646.984	Alternative fitting+	06/06-	DG-117		11.5V					4
311 CDI (906.131, 906.133, 906.135, 906.231, 906.233...)	80	OM 646.985		06/06-	DG-117		11.5V					4

Spark & Glow Plugs









Application Tables







	KW					Standard		Twin Tip		QTY
MERCEDES-BENZ <i>continued</i>										
SPRINTER 3,5 (906) (06-) <i>continued</i>										
311 CDI (906.631, 906.633, 906.635, 906.637)	80	OM 646.985		06/06-	DG-117		11.5V			4
311 CDI (906.731, 906.733, 906.735)	80	OM 646.985		06/06-	DG-117		11.5V			4
311 CDI 4x4 (906.131, 906.133, 906.135, 906.231...)	80	OM 646.985		02/08-	DG-117		11.5V			4
311 CDI 4x4 (906.631, 906.633, 906.635, 906.637)	80	OM 646.985		02/08-	DG-117		11.5V			4
311 CDI 4x4 (906.731, 906.733, 906.735)	80	OM 646.985		02/08-	DG-117		11.5V			4
313 CDI (906.131, 906.133, 906.135, 906.231, 906.233...)	95	OM 646.986		06/06-	DG-117		11.5V			4
313 CDI (906.631, 906.633, 906.635, 906.637)	95	OM 646.986		06/06-	DG-117		11.5V			4
315 CDI (906.131, 906.133, 906.135, 906.231, 906.233...)	110	M 646.990		06/06-	DG-117		11.5V			4
315 CDI (906.631, 906.633, 906.635, 906.637)	110	M646.990		06/06-	DG-117		11.5V			4
315 CDI (906.731, 906.733, 906.735)	110	OM 646.989; OM 646.990	OE: 11594801;11594901	06/06-	DG-117		11.5V			4
315 CDI 4x4 (906.131, 906.133, 906.135, 906.231...)	110	OM 646.989; OM 646.990		02/08-	DG-117		11.5V			4
315 CDI 4x4 (906.631, 906.633, 906.635, 906.637)	110	OM 646.989; OM 646.990		02/08-	DG-117		11.5V			4
315 CDI 4x4 (906.731, 906.733, 906.735)	110	OM 646.989; OM 646.990		02/08-	DG-117		11.5V			4
316 (906.133, 906.135, 906.233, 906.235)	115	M 271.951		09/08-	VXUH22	5611	0.9	-	-	VXUH22
316 (906.663, 906.635)	115	M 271.951	Eng: 30853900>	09/08-	VXUH22	5611	0.9	-	-	VXUH22
316 (906.733, 906.735)	115	M 271.951	Eng: 30853900>	09/08-	VXUH22	5611	0.9	-	-	VXUH22
316 LGT (906.133, 906.135, 906.233, 906.235)	115	M 271.951		09/08-	VXUH22	5611	0.9	-	-	VXUH22
316 LGT (906.633, 906.635)	115	M 271.951		09/08-	VXUH22	5611	0.9	-	-	VXUH22
316 NGT (906.133, 906.135, 906.233, 906.235)	115	M 271.951		09/08-	VXUH22	5611	0.9	-	-	VXUH22
316 NGT (906.633, 906.635)	115	M 271.951		09/08-	VXUH22	5611	0.9	-	-	VXUH22
316 NGT (906.733, 906.735)	115	M 271.951		09/08-	VXUH22	5611	0.9	-	-	VXUH22
318 CDI (906.131, 906.133, 906.135, 906.231, 906.233...)	135	OM 642.896; OM 642.992; OM 642.993		06/06-07/09	DG-194		4.4V			6
318 CDI (906.631, 906.633, 906.635, 906.637)	135	OM 642.896; OM 642.992; OM 642.993		06/06-07/09	DG-194		4.4V			6
318 CDI (906.731, 906.733, 906.735)	135	OM 642.896; OM 642.992; OM 642.993		02/08-	DG-194		4.4V			6
318 CDI 4x4 (906.131, 906.133, 906.135, 906.231...)	135	OM 642.896; OM 642.992; OM 642.993		02/08-07/09	DG-194		4.4V			6
318 CDI 4x4 (906.631, 906.633, 906.635, 906.637)	135	OM 642.896; OM 642.992; OM 642.993		02/08-	DG-194		4.4V			6
318 CDI 4x4 (906.731, 906.733, 906.735)	135	OM 642.896; OM 642.992; OM 642.993		02/08-	DG-194		4.4V			6
319 CDI / BlueTEC (906.131, 906.133, 906.135, 906.231...)	140	OM 642.896; OM 642.898; OM 642.992		03/09-	DG-194		4.4V			6
319 CDI / BlueTEC (906.631, 906.633, 906.635, 906.637)	140	OM 642.896; OM 642.898; OM 642.992		03/09-	DG-194		4.4V			6
319 CDI / BlueTEC (906.731, 906.733, 906.735)	140	OM 642.896; OM 642.898; OM 642.992		07/09-	DG-194		4.4V			6
319 CDI / BlueTEC 4x4 (906.131, 906.133, 906.135...)	140	OM 642.896		05/11-	DG-194		4.4V			6
319 CDI / BlueTEC 4x4 (906.631, 906.633, 906.635, 906.637)	140	OM 642.896; OM 642.898; OM 642.992		03/09-	DG-194		4.4V			6











	KW					Standard			Twin Tip		QTY	
MERCEDES-BENZ <i>continued</i>												
SPRINTER 3,5 (906) (06-) <i>continued</i>												
319 CDI / BlueTEC 4x4 (906.731, 906.733, 906.735)	140	OM 642.896; OM 642.898; OM 642.992		03/09-	DG-194		4.4V				6	
324 (906.133, 906.135, 906.233, 906.235)	190	M 272.979		06/06-	SXU22HDR8	3441	0.8	-	-	VXUH22	6	
324 (906.633, 906.635, 906.637)	190	M 272.979		06/06-	SXU22HDR8	3441	0.8	-	-	VXUH22	6	
324 (906.733, 906.735)	190	M 272.979		06/06-	SXU22HDR8	3441	0.8	-	-	VXUH22	6	
SPRINTER 3-t (903) (95-06)												
308 CDI	60	OM 611.987		04/00-05/06	DG-117		11.5V				4	
308 D	58	OM 601.943		02/95-04/00	DG-010		11.5V				4	
308 D (903.371, 903.372, 903.373)	60	OM 601.943		03/97-04/00	DG-010		11.5V				4	
308 D 2.3	58/60	OM 601.943		02/95-04/00	DG-010		11.5V				4	
310 D 4x4	75	OM 602.980		05/97-08/02	DG-110		11.5V				5	
310 D 2.9	75	OM 602.980		02/95-04/00	DG-110		11.5V				5	
311 CDI	80	OM 611.981		04/00-05/06	DG-117		11.5V				4	
311 CDI 4x4	80	OM 611.981		08/02-05/06	DG-117		11.5V				4	
312 D 2.9	90	OM 602.980	Eng: >9849	02/95-04/00	DG-001		11V				5	
312 D 2.9	90	OM 602.980	Eng: 9850>	02/95-04/00	DG-110		11.5V				5	
312 D 2.9 4x4	90	OM 602.980		05/97-08/02	DG-001		11V				5	
312 D 2.9 4x4	90	OM 602.980		05/97-08/02	DG-110		11.5V				5	
312 D 2.9 4x4	90	OM 602.980	Eng: >9849	05/97-08/02	DG-001		11V				5	
312 D 2.9 4x4	90	OM 602.980	Eng: 9850>	05/97-08/02	DG-110		11.5V				5	
313 CDI	95	OM 611.981		04/00-05/06	DG-117		11.5V				4	
313 CDI 4x4	95	OM 611.981		08/02-05/06	DG-117		11.5V				4	
314	105	M 111.979; M 111.984		02/95-05/06	K20PBR-S10	5061	1.0		K20TT	IK20TT	IK20TT	4
316 CDI	115	OM 612.981		04/00-05/06	DG-117		11.5V				5	
316 CDI 4x4	115	OM 612.981		08/02-05/06	DG-117		11.5V				5	
SPRINTER 3-t (906) (06-)												
209 CDI (906.111, 906.113, 906.211, 906.213)	65	OM 646.984	Alternative fitting+	06/06-	DG-117		11.5V				4	
209 CDI (906.611, 906.613)	65	OM 646.984	Alternative fitting+	06/06-	DG-117		11.5V				4	
211 CDI (906.111, 906.113, 906.211, 906.213)	80	OM 646.985		06/06-	DG-117		11.5V				4	
211 CDI (906.611, 906.613)	80	OM 646.985		06/06-	DG-117		11.5V				4	
211 CDI (906.711, 906.713)	80	OM 646.985		06/06-	DG-117		11.5V				4	
213 CDI (906.111, 906.113, 906.211, 906.213)	95	OM 646.986		06/06-	DG-117		11.5V				4	
213 CDI (906.611, 906.613)	95	OM 646.986	OE: 11594801;11594901	06/06-	DG-117		11.5V				4	
215 CDI (906.111, 906.113, 906.211, 906.213)	110	OM 646.989; OM 646.990	Alternative fitting+	06/06-	DG-117		11.5V				4	
215 CDI (906.611, 906.613)	110	OM 646.989; OM 646.990	Alternative fitting+	06/06-	DG-117		11.5V				4	
215 CDI (906.711, 906.713)	110	OM 646.986; OM 646.989; OM 646.990	Alternative fitting+	06/06-	DG-117		11.5V				4	
216 (906.113, 906.213)	115	M 271.951	Eng: 30853900>	09/08-	VXUH22	5611	0.9	-	-	VXUH22	4	
216 (906.613)	115	M 271.951	Eng: 30853900>	09/08-	VXUH22	5611	0.9	-	-	VXUH22	4	
216 (906.713)	115	M 271.951	Eng: 30853900>	09/08-	VXUH22	5611	0.9	-	-	VXUH22	4	
218 CDI (906.111, 906.113, 906.211, 906.213)	135	OM 642.896; OM 642.992; OM 642.993		06/06-	DG-194		4.4V				6	
218 CDI (906.611, 906.613)	135	OM 642.896; OM 642.992		06/06-	DG-194		4.4V				6	
219 CDI / BlueTEC (906.111, 906.113, 906.211, 906.213)	140	OM 642.896; OM 642.992		03/09-	DG-194		4.4V				6	
219 CDI / BlueTEC (906.611, 906.613)	140	OM 642.896; OM 642.992		03/09-	DG-194		4.4V				6	
224 (906.113, 906.213)	190	M 272.979		06/06-	SXU22HDR8	3441	0.8	-	-	VXUH22	6	
224 (906.613)	190	M 272.979		06/06-	SXU22HDR8	3441	0.8	-	-	VXUH22	6	
224 (906.713)	190	M 272.979		06/06-	SXU22HDR8	3441	0.8	-	-	VXUH22	6	







Spark & Glow Plugs

Application Tables

	KW								QTY	
MERCEDES-BENZ <i>continued</i>										
SPRINTER 4,6-t (906) (06-)										
413 CDI (906.153, 906.155, 906.253, 906.255)	95	OM 646.986	OE: 11594801;11594901	06/06-	DG-117		11.5V		4	
413 CDI (906.653, 906.655, 906.657)	95	OM 646.986	OE: 11594801;11594901	06/06-	DG-117		11.5V		4	
415 CDI (906.153, 906.155, 906.253, 906.255)	110	OM 646.989; OM 646.990	OE: 11594801;11594901	06/06-	DG-117		11.5V		4	
418 CDI (906.153, 906.155, 906.253, 906.255)	135	OM 642.896; OM 642.992; OM 642.993		06/06-	DG-194		4.4V		6	
419 CDI (906.153, 906.155, 906.253, 906.255)	140	OM 642.896; OM 642.898; OM 642.992		03/09-	DG-194		4.4V		6	
419 CDI (906.653, 906.655, 906.657)	140	OM 642.992		03/09-	DG-194		4.4V		6	
424 (906.153, 906.155, 906.253, 906.255)	190	M 272.979		06/06-	SXU22HDR8	3441	0.8	-	VXUH22	6
424 (906.953, 906.655, 906.657)	190	M 272.979		06/06-	SXU22HDR8	3441	0.8	-	VXUH22	6
SPRINTER 4-t (904) (96-06)										
408 CDI	60	OM 611.987		04/00-05/06	DG-117		11.5V		4	
408 D	58	OM 601.943		02/96-05/06	DG-010		11.5V		4	
410 D	75	OM 602.980		02/96-05/06	DG-010		11.5V		5	
410 D	75	OM 602.980		02/96-05/06	DG-110		11.5V		5	
410 D 4x4	75	OM 602.980		05/97-05/06	DG-010		11.5V		5	
410 D 4x4	75	OM 602.980		05/97-05/06	DG-110		11.5V		5	
411 CDI	80	OM 611.981		04/00-05/06	DG-117		11.5V		4	
411 CDI 4x4	80	OM 611.981		04/00-05/06	DG-117		11.5V		4	
412 D	90	OM 602.980		02/96-05/06	DG-001		11V		5	
412 D	85/90	OM 602.980		02/96-05/06	DG-110		11.5V		5	
412 D 4x4	90	OM 602.980		05/97-05/06	DG-001		11V		5	
412 D 4x4	85/90	OM 602.980		05/97-05/06	DG-110		11.5V		5	
413 CDI	95	OM 611.981		04/00-05/06	DG-117		11.5V		4	
413 CDI 4x4	95	OM 611.981		04/00-05/06	DG-117		11.5V		4	
414	105	M 111.979		02/96-05/06	K20PBR-S10	5061	1.0	K20TT	IK20TT	4
414	105	M 111.979		02/96-05/06	PK20PR11	3168	1.1	K20TT	IK20TT	4
414 4x4	105	M 111.979		05/97-05/06	PK20PR11	3168	1.1	K20TT	IK20TT	4
416 CDI	115	OM 612.981		04/00-05/06	DG-117		11.5V		5	
416 CDI 4x4	115	OM 612.981		04/00-05/06	DG-117		11.5V		5	
SPRINTER 5-t (905) (01-)										
616 CDI (905.612, 905.613, 905.622, 905.623)	115	OM 612.981	Alternative fitting+	04/01-05/06	DG-117		11.5V		5	
616 CDI (905.612, 905.622, 905.623)	115	OM 612.981	Alternative fitting+	04/01-	DG-117		11.5V		5	
SPRINTER 5-t (906) (06-)										
509 CDI (906.153, 906.155, 906.253, 906.255)	65	OM 646.984	Alternative fitting+	06/06-	DG-117		11.5V		4	
509 CDI (906.653, 906.655, 906.657)	65	OM 646.984		06/06-	DG-117		11.5V		4	
511 CDI (906.153, 906.155, 906.253, 906.255)	80	OM 646.985		06/06-	DG-117		11.5V		4	
511 CDI (906.653, 906.655, 906.657)	80	OM 646.985		06/06-	DG-117		11.5V		4	
511 CDI 4x4 (906.135, 906.155, 906.253, 906.255)	80	OM 646.985		06/06-	DG-117		11.5V		4	
511 CDI 4x4 (906.653, 906.6355, 906.657)	80	OM 646.985		06/06-	DG-117		11.5V		4	
513 CDI (906.135, 906.155, 906.253, 906.255)	95	OM 646.986	Alternative fitting+	06/06-	DG-117		11.5V		4	
513 CDI (906.653, 906.655, 906.657)	95	OM 646.986	Alternative fitting+	06/06-	DG-117		11.5V		4	
515 CDI (906.153, 906.155, 906.253, 906.255)	110	OM 646.989; OM 646.990	OE: 11594801;11594901	06/06-	DG-117		11.5V		4	
515 CDI (906.653, 906.655, 906.657)	110	OM 646.986; OM 646.989; OM 646.990	Alternative fitting+	06/06-	DG-117		11.5V		4	
515 CDI 4x4 (906.153, 906.155, 906.253, 906.255)	110	OM 646.989; OM 646.990	OE: 11594801;11594901	06/06-	DG-117		11.5V		4	
515 CDI 4x4 (906.653, 906.655, 906.657)	110	OM 646.989; OM 646.990	OE: 11594801;11594901	06/06-	DG-117		11.5V		4	





	KW					Standard		Twin Tip			QTY
MERCEDES-BENZ <i>continued</i>											
SPRINTER 5-t (906) (06-) <i>continued</i>											
516 (906.153, 906.155, 906.253, 906.255)	115	M 271.951		09/08-	VXUH22	5611	0.9	-	-	VXUH22	4
516 NGT (906.153, 906.155, 906.253, 906.255)	115	M 271.951		09/08-	VXUH22	5611	0.9	-	-	VXUH22	4
518 CDI (906.153, 906.155, 906.253, 906.255)	135	OM 642.896; OM 642.992; OM 642.993		06/06-	DG-194		4.4V				6
518 CDI (906.653, 906.655, 906.657)	135	OM 642.896; OM 642.992; OM 642.993		06/06-	DG-194		4.4V				6
518 CDI 4x4 (906.153, 906.155, 906.253, 906.255)	135	OM 642.992; OM 642.993		06/06-03/09	DG-194		4.4V				6
519 CDI / BlueTEC (906.153, 906.155, 906.253, 906.255)	140	OM 642.896; OM 642.898; OM 642.992		03/09-	DG-194		4.4V				6
519 CDI / BlueTEC (906.653, 906.655, 906.657)	140	OM 642.896; OM 642.898; OM 642.992		03/09-	DG-194		4.4V				6
519 CDI / BlueTEC 4x4 (906.153, 906.155, 906.253, 906.255)	140	OM 642.896		03/09-	DG-194		4.4V				6
519 CDI / BlueTEC 4x4 (906.653, 906.655, 906.657)	140	OM 642.896		03/09-	DG-194		4.4V				6
524 (906.153, 906.155, 906.253, 906.255)	190	M 272.979		06/06-	SXU22HDR8	3441	0.8	-	-	VXUH22	6
524 (906.653, 906.655, 906.657)	190	M 272.979		06/06-	SXU22HDR8	3441	0.8	-	-	VXUH22	6
T1 (601) (77-96)											
207 D 2.4	53	OM 616.937; OM 616.939		06/82-01/90	DG-001		11V				4
208 2.3	63	M 115.955; M 115.972		05/77-12/82	W20EP-U	3043	0.8	W20TT	IW20TT	IW20TT	4
208 D 2.3	58/60	OM 601.940		10/88-02/96	DG-010		11.5V				4
209 D 2.9	65	OM 617.913		12/82-01/90	DG-001		11V				5
210 2.3	70/77	M 102.942; M 102.945; M 102.946		04/77-02/96	T20EP-U	5031	0.8	T20TT	IT20TT	IT20TT	4
210 2.3	63	M 115.955		04/77-10/89	W20EP-U	3043	0.8	W20TT	IW20TT	IW20TT	4
210 D 2.8	70/72	OM 602.940		10/88-02/96	DG-010		11.5V				5
210 D 2.9	70	OM 602.940		11/88-02/96	DG-010		11.5V				5
T1 (602) (77-96)											
307 D 2.4	53	OM 616.937; OM 616.939		06/82-01/90	DG-001		11V				4
308 D 2.3	58/60	OM 601.940		06/89-02/96	DG-010		11.5V				4
309 D 3.0	65	OM 617.913		10/82-01/90	DG-001		11V				5
310 D 2.9	70/72	OM 602.940		06/89-02/96	DG-010		11.5V				5
T1 / TN (611) (81-95)											
407 D (611.317, 611.318)	53	OM 616.913; OM 616.939		07/81-01/89	DG-001		11V				4
407 D (611.367, 611.368)	53	OM 616.913; OM 616.939		07/81-01/89	DG-001		11V				4
408 D (611.317, 611.318)	58/60	OM 601.940		11/88-06/95	DG-010		11.5V				4
408 D (611.367, 611.368)	58/60	OM 601.940		11/88-06/95	DG-010		11.5V				4
410 D (611.417, 611.418)	70/72	OM 602.940		11/88-06/95	DG-010		11.5V				5
410 D (611.467, 611.468)	70/72	OM 602.940		11/88-06/95	DG-010		11.5V				5
T2 / LN1 (86-94)											
508 D (667.301, 667.302, 667.341, 667.342)	58	OM 601.941		03/89-12/94	DG-010		11.5V				4
508 D (667.361, 667.362)	58	OM 601.941		03/89-12/94	DG-010		11.5V				4
VANEO (414) (02-05)											
1.6 (414.700)	60/75	M 166.961		02/02-07/05	K20PBR-S10	5061	1.0	K20TT	IK20TT	IK20TT	4
1.7 CDI (414.700)	55/67	OM 668.914		02/02-07/05	DG-155		11.5V				4
1.9 (414.700)	92	M 166.991		02/02-07/05	K20PBR-S10	5061	1.0	K20TT	IK20TT	IK20TT	4
VARIO (96-)											
512 D (667.321, 667.322, 667.323)	90	OM 602.984		09/96-	DG-110		11.5V				5
512 D (667.351, 667.352, 667.353)	90	OM 602.984		09/96-	DG-110		11.5V				5
612 D (668.321, 668.322, 668.323)	90	OM 602.984; OM 602.985		09/96-	DG-110		11.5V				5
612 D (668.331, 668.332)	90	OM 602.984; OM 602.985		09/96-	DG-110		11.5V				5
612 D (668.351, 668.352, 668.353)	90	OM 602.984; OM 602.985		09/96-	DG-110		11.5V				5
812 D (670.321, 670.322, 670.323, 670.324)	90	OM 602.984; OM 602.985		09/96-	DG-110		11.5V				5







	KW										QTY
MERCEDÉS-BENZ <i>continued</i>											
VARIO (96-) <i>continued</i>											
812 D (670.331, 670.332)	90	OM 602.984; OM 602.985		09/96-	DG-110		11.5V				5
812 D (670.351, 670.352, 670.353)	90	OM 602.984; OM 602.985		09/96-	DG-110		11.5V				5
O 812 (670.373, 670.674)	90	OM 602.984; OM 602.985		09/96-	DG-110		11.5V				5
V-CLASS (638/2) (96-03)											
V 200 (638.214, 638.294)	95	M 111.948; M 111.950		02/97-07/03	K20PBR-S10	5061	1.0	K20TT	IK20TT	IK20TT	4
V 200 CDI (638.294)	75	OM 611.980		03/99-07/03	DG-117		11.5V				4
V 220 CDI (638.294)	90	OM 611.980		03/99-07/03	DG-117		11.5V				4
V 230 (638.234, 638.294)	105	M 111.978		10/96-07/03	K20PBR-S10	5061	1.0	K20TT	IK20TT	IK20TT	4
V 230 TD (638.274)	72	OM 601.970		09/96-07/03	DG-010		11.5V				4
V 280 (638.244, 638.294)	128	M 104.900		08/97-07/03	K20TXR	5063	1.0	K20TT	IK20TT	IK20TT	6
VIANO (W639) (03-)											
3,0	140	M 112.951	OEM Optional	09/03-	PK16PR-L11	3275	1.1	-	IK16TT	IK16TT	12
3,2	160	M 112.951	OEM Optional	09/03-	PK16PR-L11	3275	1.1	-	IK16TT	IK16TT	12
3,5	190	M 272.978		09/07-	SXU22HDR8	3441	0.8	-	-	VXUH22	6
3,7	170	M 112.976		06/04-	PK16PR-L11	3275	1.1	-	IK16TT	IK16TT	12
CDI 2.0	80/85	OM 646.982		09/03-	DG-117		11.5V				4
CDI 2.0	100	OM 651.940		07/10-	DG-194		4.4V				4
CDI 2.0 4-matic	80	OM 646.982		09/07-	DG-117		11.5V				4
CDI 2.0 4-matic	100	OM 651.940		07/10-	DG-194		4.4V				4
CDI 2.2	110	OM 646.982		09/03-	DG-117		11.5V				4
CDI 2.2	120	OM 651.940		07/10-	DG-194		4.4V				4
CDI 2.2 4-matic	110	OM 646.982		07/05-	DG-117		11.5V				4
CDI 2.2 4-matic	120	OM 651.940		07/10-	DG-194		4.4V				4
CDI 3.0	150/165	OM 642.990		03/06-	DG-194		4.4V				6
VITO (638) (96-03)											
108 CDI 2.2 (638.094)	60	OM 611A (60 KW CDI)		03/99-07/03	DG-117		11.5V				4
108 CDI 2.2 (638.194)	60	OM 611A (60 KW CDI)		03/99-07/03	DG-117		11.5V				4
108 D 2.3 (638.064)	58	OM 601.942		03/97-07/03	DG-010		11.5V				4
108 D 2.3 (638.164)	58	OM 601.942		02/96-07/03	DG-010		11.5V				4
110 CDI 2.2 (638.094)	75	OM 611LA (75 KW CDI)		03/99-07/03	DG-117		11.5V				4
110 CDI 2.2 (638.194)	75	OM 611LA (75 KW CDI)		03/99-07/03	DG-117		11.5V				4
110 D 2.3 (638.074)	72	OM 601.970		03/97-07/03	DG-010		11.5V				4
110 TD 2.3 (638.174)	72	OM 601.970		02/96-07/03	DG-010		11.5V				4
112 CDI 2.2 (638.094)	90	OM 611.980		03/99-07/03	DG-117		11.5V				4
112 CDI 2.2 (638.194)	90	OM 611.980		03/99-07/03	DG-117		11.5V				4
113 2.0 (638.014, 638.094)	95	M 111.948; M 111.950		03/97-07/03	K20PBR-S10	5061	1.0	K20TT	IK20TT	IK20TT	4
113 2.0 (638.114, 638.194)	95	M 111.948; M 111.950		02/96-07/03	K20PBR-S10	5061	1.0	K20TT	IK20TT	IK20TT	4
114 2.3 (638.034, 638.094)	105	M 111.978		03/97-07/03	K20PBR-S10	5061	1.0	K20TT	IK20TT	IK20TT	4
114 2.3 (638.134, 638.194)	105	M 111.978		12/96-07/03	K20PBR-S10	5061	1.0	K20TT	IK20TT	IK20TT	4
VITO / MIXTO (W639) (03-)											
109 CDI	65/70	OM 646.980; OM 646.981; OM 646.983		09/03-	DG-117		11.5V				4
109 CDI 4x4	70	OM 646.981		09/07-07/10	DG-117		11.5V				4
111 CDI	80/85	OM 646.980; OM 646.982		09/03-	DG-117		11.5V				4
111 CDI (639.701)	85	OM 646.980		09/07-	DG-117		11.5V				4
111 CDI 4x4	80	OM 646.982		09/07-	DG-117		11.5V				4
115 CDI	110	OM 646.980; OM 646.982		09/03-	DG-117		11.5V				4
115 CDI 4x4	110	OM 646.982		07/06-	DG-117		11.5V				4
119	140	M 112.951	OEM Optional	09/03-	PK16PR-L11	3275	1.1	-	IK16TT	IK16TT	12
120 CDI	150	OM 642.990		07/06-07/10	DG-194		4.4V				6
122	160	M 112.951	OEM Optional	09/03-01/06	PK16PR-L11	3275	1.1	-	IK16TT	IK16TT	12
122 CDI	165	OM 642.890		09/10-	DG-194		4.4V				6
123	170	M 112.976		06/04-02/09	PK16PR-L11	3275	1.1	-	IK16TT	IK16TT	12
123 (639.603)	170	M 112.976		06/04-07/08	PK16PR-L11	3275	1.1	-	IK16TT	IK16TT	12
126	190	M 272.978		09/07-	SXU22HDR8	3441	0.8	-	-	VXUH22	6

	KW					Standard		Twin Tip		QTY	
MERCEDES-BENZ CV											
O 100											
	70	OM 602.940		01/94-06/95	DG-010		11.5V			4	
UNIMOG											
	38	OM 616.942; OM 616.943		05/88-	DG-001		11V			4	
	65/71	OM 602.941; OM 602.948		11/92-	DG-010		11.5V			4	
	80/85	OM 602.981; OM 602.989		07/96-	DG-155		11.5V			4	
MERCURY											
GRAND MARQUIS (91-97)											
4.6	157			01/91-12/97	T20EPR-U15	5033	1.5	T20TT	IT20TT	IT20TT	8
MG											
1300 II (67-70)											
1300	52			09/67-09/70	W20EPR-U	3047	0.8	W20TT	IW20TT	IW20TT	4
MAESTRO (83-90)											
2.0 EFI	86	20HA51;20HC78		10/84-09/90	W20EPR-U	3047	0.8	W20TT	IW20TT	IW20TT	4
2.0 Turbo	112	20HB63		10/88-09/90	W20EPR-U	3047	0.8	W20TT	IW20TT	IW20TT	4
1600	76	16H956		03/83-09/84	W20EPR-U	3047	0.8	W20TT	IW20TT	IW20TT	4
METRO (82-90)											
1300	54	12HD26		11/87-09/90	W20EX-U	3062	0.8	W20TT	IW20TT	IW20TT	4
Turbo	69	12H959AA;12HC15		10/82-09/90	W20EPR-U	3047	0.8	W20TT	IW20TT	IW20TT	4
MG 6 (10-)											
1.8 T	118	18N4TI		11/10-	PK20PR-L11	3142	1.1	-	IK20TT	IK20TT	4
MG TF (02-09)											
115	85	16K4F4		03/02-04/05	PK16PR-L11	3275	1.1	-	IK16TT	IK16TT	4
120	88	18 K4F		03/02-04/05	PK16PR-L11	3275	1.1	-	IK16TT	IK16TT	4
135	100	18 K4F		03/02-04/05	PK16PR-L11	3275	1.1	-	IK16TT	IK16TT	4
160	118	18 K4K		03/02-04/05	PK20PR-L11	3142	1.1	-	IK20TT	IK20TT	4
MG X-POWER (03-08)											
5.0 SV-R	294			01/05-04/08	PK20PR-P8	3245	0.8	-	IK20TT	IK20TT	8
MG ZR (01-05)											
2.0 TD	74/83	20 T2N		06/01-04/05	DG-101		11V				4
105	76	14K4F4		06/01-04/05	PK20PR-P8	3245	0.8	-	IK20TT	IK20TT	4
120	86	18 K4F		06/01-04/05	PK16PR-L11	3275	1.1	-	IK16TT	IK16TT	4
160	118	18K4K		06/01-04/05	PK20PR-L11	3142	1.1	-	IK20TT	IK20TT	4
MG ZS (01-05)											
1.6	79/82	16 K4F; 16K4F4		07/03-10/05	PK16PR-L11	3275	1.1	-	IK16TT	IK16TT	4
1.6	79/82	16 K4F; 16K4F4		11/01-04/05	PK20PR-L11	3142	1.1	-	IK20TT	IK20TT	4
2.0 TD	74/83	20 T2N		01/04-10/05	DG-101		11V				4
120	86	18 K4F; 18K4F		07/01-10/05	PK16PR-L11	3275	1.1	-	IK16TT	IK16TT	4
180	130	25KV6-177		07/01-10/05	PK16PR-L11	3275	1.1	-	IK16TT	IK16TT	6
180	130	25KV6-177	Flexible fuel	07/01-10/05	PK20PR-L11	3142	1.1	-	IK20TT	IK20TT	6
MG ZT (01-05)											
1.8 16V	88	18 K4F; 18K4F		01/03-07/05	PK16PR-L11	3275	1.1	-	IK16TT	IK16TT	4
1.8 16V	88	18 K4F	Flexible fuel	01/03-07/05	PK20PR-L11	3142	1.1	-	IK20TT	IK20TT	4
1.8 T 16V	118	18K4T		01/03-07/05	PK16PR-L11	3275	1.1	-	IK16TT	IK16TT	4
1.8 T 16V	118	18K4T	Flexible fuel	01/03-07/05	PK20PR-L11	3142	1.1	-	IK20TT	IK20TT	4
2.0 CDTi	85/96	204D2		06/02-07/05	DG-145		11V				4
160	118	25K6(160)		01/03-07/05	PK16PR-L11	3275	1.1	-	IK16TT	IK16TT	6
160	118	25K6(160)	Flexible fuel	01/03-07/05	PK20PR-L11	3142	1.1	-	IK20TT	IK20TT	6
180	130	25KV6-177		01/03-07/05	PK16PR-L11	3275	1.1	-	IK16TT	IK16TT	6
180	130	25KV6-177	Flexible fuel	01/03-07/05	PK20PR-L11	3142	1.1	-	IK20TT	IK20TT	6
190	140	25K6(190)		06/01-07/05	PK16PR-L11	3275	1.1	-	IK16TT	IK16TT	6
190	140	25K6(190)	Flexible fuel	06/01-07/05	PK20PR-L11	3142	1.1	-	IK20TT	IK20TT	6
MGA (55-62)											
1.5	51			05/55-04/60	W20ESR-U	3057	0.8	-	-	-	4
1.6	58			01/58-04/60	W20ESR-U	3057	0.8	-	-	-	4
1.6	81			01/58-05/60	W22ESR-U	3098	0.8	-	-	-	4
MGB (66-80)											
1.8	68/70/71			01/66-11/80	W20EPR-U	3047	0.8	W20TT	IW20TT	IW20TT	4
3.5	101	15G		01/73-12/76	W16FPR-U	4192	0.7	-	-	-	8
MGC (67-69)											
3.0	108			01/67-09/69	W20EPR-U	3047	0.8	W20TT	IW20TT	IW20TT	6
MGF (95-02)											
1.8 i VVC	118	18 K4K		10/01-03/02	PK20PR-P8	3245	0.8	-	IK20TT	IK20TT	4
1.6	82	16K4F4		02/00-03/02	PK20PR-P8	3245	0.8	-	IK20TT	IK20TT	4

Spark & Glow Plugs

Application Tables

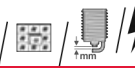





	KW				Standard			Twin Tip				QTY
MG <i>continued</i>												
MGF (95-02) <i>continued</i>												
1.8 i 16V	88	18 K4F		03/95-03/02	PK20PR-P8	3245	0.8	-	IK20TT	IK20TT		4
1.8 i VVC	107	18 K4K		03/95-03/02	PK20PR-L11	3142	1.1	-	IK20TT	IK20TT		4
MIDGET (64-79)												
1.1	41			01/64-12/66	W16EPR-U	3021	0.8	W16TT	IW16TT	IW16TT		4
1.3	48			01/67-09/74	W16EPR-U	3021	0.8	W16TT	IW16TT	IW16TT		4
1.5	49			09/74-12/79	W16EPR-U	3021	0.8	W16TT	IW16TT	IW16TT		4
MONTEGO (84-90)												
2.0 EFI	86	20HA;20HB55; 20HB59, 20HB60, 20HB69/B78, 20HD55		04/84-09/90	W20EPR-U	3047	0.8	W20TT	IW20TT	IW20TT		4
MINI												
MINI (R50, R53) (01-06)												
1.4	55			04/03-09/06	K20TXR	5063	1.0	K20TT	IK20TT	IK20TT		4
Cooper	85	W10 B16 A		06/01-09/06	K20TXR	5063	1.0	K20TT	IK20TT	IK20TT		4
Cooper S	120/ 125	W11 B16 A		03/02-09/06	K20TXR	5063	1.0	K20TT	IK20TT	IK20TT		4
John Cooper Works	160	W11 B16 A		03/06-09/06	IK22	5310	0.8	-	-	VK22		4
One	66	W10 B16 A		06/01-09/06	K20TXR	5063	1.0	K20TT	IK20TT	IK20TT		4
One D	55/65	1ND; 1ND-TV		06/03-09/06	DG-240		11V					4
S Works	147	W11 B16 A		11/03-06/05	IK22	5310	0.8	-	-	VK22		4
Works	155	W11 B16 A		11/03-09/06	IK22	5310	0.8	-	-	VK22		4
MINI (R56) (06-)												
Cooper	85/ 88/ 90	N12 B16 A; N16 B16 A		03/10-	IXUH22	5353	0.9	-	-	VXUH22		4
Cooper D	80	9HZ (DV6TED4); W16 D16		03/07-	DG-180		11V					4
Cooper D	82	N47 C16 A; N47 C20 A		06/10-	DG-607		4.4V					4
Cooper S	120/ 128/ 135/ 147	N14 B16 A; N18 B16 A		03/10-	IXUH22	5353	0.9	-	-	VXUH22		4
Cooper SD	100/ 105	N47 C20 A		02/11-	DG-607		4.4V					4
John Cooper Works	155	N14 B16 C		03/08-	IXUH22	5353	0.9	-	-	VXUH22		4
John Cooper Works GP	160	N18 B16 B		09/12-	IXUH22	5353	0.9	-	-	VXUH22		4
One	55/ 70/ 72	N12 B14 A; N16 B16 A		03/09-	IXUH22	5353	0.9	-	-	VXUH22		4
One D	66	9HZ (DV6TED4)		06/09-07/10	DG-180		11V					4
One D	66	N47 C16 A		07/10-	DG-607		4.4V					4
MINI Clubman (R55) (07-)												
Cooper	85/ 88/ 90	N12 B16 A; N16 B16 A		03/10-	IXUH22	5353	0.9	-	-	VXUH22		4
Cooper D	80	9HZ (DV6TED4)		10/07-	DG-180		11V					4
Cooper D	82	N47 C16 A; N47 C20 A		03/10-	DG-607		4.4V					4
Cooper S	120/ 128/ 135/ 147	N14 B16 A; N18 B16 A		10/07-	IXUH22	5353	0.9	-	-	VXUH22		4
Cooper SD	100/ 105	N47 C20 A		02/11-	DG-607		4.4V					4
John Cooper Works	155	N14 B16 C		03/08-	IXUH22	5353	0.9	-	-	VXUH22		4
One	70/72	N12 B14 A; N16 B16 A		03/09-	IXUH22	5353	0.9	-	-	VXUH22		4
One D	66	N47 C16 A		03/10-	DG-607		4.4V					4
MINI Convertible (R52) (04-07)												
Cooper	85	W10 B16 A		07/04-11/07	K20TXR	5063	1.0	K20TT	IK20TT	IK20TT		4
Cooper S	120/ 125	W11 B16 A		07/04-11/07	K20TXR	5063	1.0	K20TT	IK20TT	IK20TT		4
John Cooper Works	155	W11 B16 A		07/04-11/07	IK22	5310	0.8	-	-	VK22		4
One	66	W10 B16 A		07/04-11/07	K20TXR	5063	1.0	K20TT	IK20TT	IK20TT		4
MINI Convertible (R57) (08-)												
Cooper	85/ 88/ 90	N12 B16 A; N16 B16 A		03/09-	IXUH22	5353	0.9	-	-	VXUH22		4
Cooper D	82	N47 C16 A; N47 C20 A		06/10-	DG-607		4.4V					4
Cooper S	128/ 135/ 147	N14 B16 A; N18 B16 A		03/09-	IXUH22	5353	0.9	-	-	VXUH22		4
Cooper SD	105	N47 C20 A		02/11-	DG-607		4.4V					4

	KW								QTY		
MINI continued											
MINI Convertible (R57) (08-) continued											
John Cooper Works	155	N14 B16 C		03/08-	IXUH22	5353	0.9	-	-	VXUH22	4
One	72	N16 B16 A		03/10-	IXUH22	5353	0.9	-	-	VXUH22	4
MINI Countryman (R60) (10-)											
Cooper	85/90	N16 B16 A		06/10-	IXUH22	5353	0.9	-	-	VXUH22	4
COOPER D	82	N47 C16 A; N47 C20 A		06/10-	DG-607		4.4V				4
COOPER D ALL4	82	N47 C16 A; N47 C20 A		06/10-	DG-607		4.4V				4
COOPER S	135/147	N18 B16 A		06/10-	IXUH22	5353	0.9	-	-	VXUH22	4
Cooper S ALL4	120/135	N18 B16 A		06/10-	IXUH22	5353	0.9	-	-	VXUH22	4
Cooper S JCW	160	N18 B16 A		09/12-	IXUH22	5353	0.9	-	-	VXUH22	4
Cooper SD	105	N47 C20 A		02/11-	DG-607		4.4V				4
Cooper SD ALL4	100/105	N47 C20 A		02/11-	DG-607		4.4V				4
ONE	72	N16 B16 A		06/10-	IXUH22	5353	0.9	-	-	VXUH22	4
ONE D	66	N47 C16 A		06/10-	DG-607		4.4V				4
MINI Coupe (R58) (11-)											
Cooper	85/90	N16 B16 A		09/11-	IXUH22	5353	0.9	-	-	VXUH22	4
Cooper S	120/135/147	N18 B16 A		09/11-	IXUH22	5353	0.9	-	-	VXUH22	4
Cooper SD	105	N47 C20 A		09/11-	DG-607		4.4V				4
John Cooper Works	155	N14 B16 C		09/11-	IXUH22	5353	0.9	-	-	VXUH22	4
MINI Paceman (R61) (12-)											
Cooper	90	N16 B16 A		04/12-	IXUH22	5353	0.9	-	-	VXUH22	4
Cooper D	82	N47 C16 A		09/12-	DG-607		4.4V				4
Cooper D ALL4	82	N47 C16 A		09/12-	DG-607		4.4V				4
Cooper S	135	N18 B16 A		04/12-	IXUH22	5353	0.9	-	-	VXUH22	4
Cooper S ALL4	135	N18 B16 A		04/12-	IXUH22	5353	0.9	-	-	VXUH22	4
Cooper SD	105	N47 C20 A		10/12-	DG-607		4.4V				4
Cooper SD ALL4	105	N47 C20 A		10/12-	DG-607		4.4V				4
John Cooper Works	160	N18 B16 C		09/12-	IXUH22	5353	0.9	-	-	VXUH22	4
MINI Roadster (R59) (12-)											
Cooper	85/90	N16 B16 A		02/12-	IXUH22	5353	0.9	-	-	VXUH22	4
Cooper S	120/135/147	N18 B16 A		02/12-	IXUH22	5353	0.9	-	-	VXUH22	4
Cooper SD	100/105	N47 C20 A		02/12-	DG-607		4.4V				4
John Cooper Works	155	N14 B16 C; N18 B16 C		02/12-	IXUH22	5353	0.9	-	-	VXUH22	4
MITSUBISHI											
3000 GT (92-99)											
3.0 i 24V 4WD (Z16A)	210	6G72-4H;6G72-4V; 6G72-GG		06/92-08/99	PK20PR-P11	3141	1.1	K20TT	IK20TT	IK20TT	6
ASX (10-)											
1.6	85/86	4A92		05/10-	VFKH16	5654	1.1	-	IKH16TT	IKH16TT	4
1.8	102	4B10		02/10-	SK20PR-A8	3403	0.8	-	IK20TT	IK20TT	4
1.8 4WD	102	4B10		02/10-	K20PSR-B8	3431	0.8	-	IK20TT	IK20TT	4
1.8 4WD	102	4B10	OEM Optional	02/10-	SK20PR-A8	3403	0.8	-	IK20TT	IK20TT	4
2.0 i	110/118	4B11		06/10-	SK20PR-A8	3403	0.8	-	IK20TT	IK20TT	4
2.0 i 4WD	110/118	4B11		06/10-	SK20PR-A8	3403	0.8	-	IK20TT	IK20TT	4
CANTER (96-01)											
2.8 TDi	85	4M40-2AT		10/98-07/01	DG-306		11V				4
CANTER (01-10)											
3.0 TDi	92	4M42-0AT		08/01-07/05	DG-187		11V				4
CARISMA (95-06)											
1.6 (DA1A)	66/70/73/76	4G92		07/95-06/06	K20PR-U11	3121	1.1	K20TT	IK20TT	IK20TT	4
1.8 (DA2A)	85	4G93-21;4G93-23		07/95-02/99	K20PR-U11	3121	1.1	K20TT	IK20TT	IK20TT	4
1.8 (DA2A)	85	4G93	Direct Injection	03/99-12/02	VKB20	5625	1.1	-	-	VKB20	4
1.8 16V (DA2A)	103	4G93-41		07/95-04/97	K20PR-U11	3121	1.1	K20TT	IK20TT	IK20TT	4
1.8 16V GDI (DA2A)	92	4G93 (GDI)	Direct Injection	09/97-12/03	VKB20	5625	1.1	-	-	VKB20	4
1.8 GDI (DA2A)	90	4G93 (GDI)		10/00-06/06	VKB20	5625	1.1	-	-	VKB20	4
1.9 DI-D	85	F9Q2		09/00-06/06	DG-005		11V				4
1.9 DI-D (DA5A)	75	F9Q1		09/00-06/06	DG-005		11V				4
1.9 TD (DA4A)	66	F8QT		10/96-09/00	DG-012		11V				4

Spark & Glow Plugs



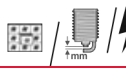





Application Tables







KW	KW	KW	NOTE	21	Standard			Twin Tip			QTY
					Standard	Standard	Standard	Twin Tip	Twin Tip	Twin Tip	
MITSUBISHI <i>continued</i>											
CARISMA (95-06) <i>continued</i>											
2.0 16V GT EVO VI/VII	206	4G63 Turbo		11/99-06/06	P22PR8	3302	0.8	-	-	WV22	4
COLT CZC (06-09)											
1.5	80	4A91		05/06-07/09	K20HR-U11	3381	1.1	KH20TT	IKH20TT	IKH20TT	4
1.5 Turbo	110	4G15T		05/06-07/09	K20HR-U11	3381	1.1	KH20TT	IKH20TT	IKH20TT	4
COLT I (78-84)											
1.2 GL (A151A)	40	4 G 11		12/78-01/84	W16EPR-U	3021	0.8	W16TT	IW16TT	IW16TT	4
1.4 GLX,GT (A152A)	51	4 G 12		05/79-01/84	W16EPR-U	3021	0.8	W16TT	IW16TT	IW16TT	4
1.4 Turbo (A152A)	77	4 G 12 T		09/81-01/84	W20EPR-U	3047	0.8	W20TT	IW20TT	IW20TT	4
COLT II (84-88)											
1.2 EL, GL (C15A)	40/44	4G16		02/84-04/88	W20EPR-U	3047	0.8	W20TT	IW20TT	IW20TT	4
1.3 EL, GL (C11A)	49	G13B		06/86-04/88	W20EPR-U11	3049	1.1	W20TT	IW20TT	IW20TT	4
1.5 GLX (C12A)	55	4 G 15		09/84-04/88	W20EPR-U	3047	0.8	W20TT	IW20TT	IW20TT	4
1.5 GLX (C12A)	51	G15B		09/85-04/88	W20EPR-U11	3049	1.1	W20TT	IW20TT	IW20TT	4
1.6 Turbo Eci (C13A)	92	4 G 32 T/C		02/84-04/88	W20EPR-U	3047	0.8	W20TT	IW20TT	IW20TT	4
1.6 Turbo Eci (C13A)	77	4G32T		07/86-04/88	W22EPR-U	3088	0.8	W22TT	-	WV22	4
1.8 GL Diesel (C14A)	43/44	4D65		02/84-04/88	DG-198		11V				4
COLT III (88-92)											
1.3 (C51A)	51	4G13 (8V)		04/88-06/90	W20EPR-U	3047	0.8	W20TT	IW20TT	IW20TT	4
1.3 12V (C51A)	55	4 G 13 (12V)		04/88-05/92	W20EPR-U11	3049	1.1	W20TT	IW20TT	IW20TT	4
1.3 GL (C61A)	44	4 G 13		04/88-12/90	W16EP-U	3018	0.8	W16TT	IW16TT	IW16TT	4
1.5 (C52A) CAT	66	4 G 15		07/90-05/92	W20EPR-U11	3049	1.1	W20TT	IW20TT	IW20TT	4
1.5 GLXi (C52A)	62	4G61		04/88-05/92	W20EPR-U	3047	0.8	W20TT	IW20TT	IW20TT	4
1.6 GTi 16V (C53A)	91	4G61		04/88-05/90	W20EPR-U	3047	0.8	W20TT	IW20TT	IW20TT	4
1.8 Diesel GLX (C54A)	44	4D65		04/88-05/92	DG-198		11V				4
1.8 GTi 16V (C58A) CAT	100	4G67		06/90-05/92	W20EPR-U11	3049	1.1	W20TT	IW20TT	IW20TT	4
COLT IV (92-96)											
1.3 GLi 12V (CA1A)	55	4 G 13(BJ92-...;12V)		04/92-04/96	W16EPR-U11	3201	1.1	W16TT	IW16TT	IW16TT	4
1.6 (CA4A)	66	4G92		02/94-04/96	K20PR-U11	3121	1.1	K20TT	IK20TT	IK20TT	4
1.6 (CA4A)	66	4G92 MVV	LEAN BURN	02/94-04/96	K16PR-U11	3130	1.1	K16TT	IK16TT	IK16TT	4
1.6 4WD (CC4A)	84	4G92		08/93-08/95	K20PR-U11	3121	1.1	K20TT	IK20TT	IK20TT	4
1.6 4WD (CC4A)	84	4G92 MVV	LEAN BURN	12/93-08/95	K16PR-U11	3130	1.1	K16TT	IK16TT	IK16TT	4
1.6 4WD (CC4A)	84	4G92 MVV	LEAN BURN	08/93-11/93	K20PR-U11	3121	1.1	K20TT	IK20TT	IK20TT	4
1.6 GLXi 16V (CA4A)	83	4G92		04/92-04/96	K20PR-U11	3121	1.1	K20TT	IK20TT	IK20TT	4
1.6 GLXi 16V (CA4A)	83	4G92 MVV	LEAN BURN	12/93-04/96	K16PR-U11	3130	1.1	K16TT	IK16TT	IK16TT	4
1.6 GLXi 16V (CA4A)	83	4G92 MVV	LEAN BURN	04/92-11/93	K20PR-U11	3121	1.1	K20TT	IK20TT	IK20TT	4
1.8 GTi 16V (CA5A)	103	4G93		04/92-04/96	K20PR-U11	3121	1.1	K20TT	IK20TT	IK20TT	4
COLT V (95-03)											
1300	60	4G13-6		09/00-09/03	W16EPR-U11	3201	1.1	W16TT	IW16TT	IW16TT	4
1300 GL, GLX (CJ1A)	55	4G13-38;4G13-380		05/96-09/00	W16EPR-U11	3201	1.1	W16TT	IW16TT	IW16TT	4
1500 (CJ2A)	69	4G15		11/95-05/00	W16EPR-U	3021	0.8	W16TT	IW16TT	IW16TT	4
1600	76	4G92		09/00-09/03	K20PR-U11	3121	1.1	K20TT	IK20TT	IK20TT	4
1600	76	4G92 MVV	LEAN BURN	09/00-09/03	K20PR-U11	3121	1.1	K20TT	IK20TT	IK20TT	4
1600 GLX (CJ4A)	66	4G92		05/96-09/00	K20PR-U11	3121	1.1	K20TT	IK20TT	IK20TT	4
1600 GLX (CJ4A)	66	4G92 MVV	LEAN BURN	05/96-05/99	K16PR-U11	3130	1.1	K16TT	IK16TT	IK16TT	4
1600 GLX (CJ4A)	66	4G92 MVV	LEAN BURN	06/99-09/00	K20PR-U11	3121	1.1	K20TT	IK20TT	IK20TT	4
COLT VI (04-)											
1.1	55	3A91		10/04-06/12	K20HR-U11	3381	1.1	KH20TT	IKH20TT	IKH20TT	3
1.1 Bifuel	55	3A91		10/04-06/12	K20HR-U11	3381	1.1	KH20TT	IKH20TT	IKH20TT	3
1.3	68/70	4A90		06/10-06/12	VFKH16	5654	1.1	-	IKH16TT	IKH16TT	4
1.3	68/70	4A90		06/10-06/12	VKH20	5618	1.1	-	IKH20TT	IKH20TT	4
1.3 4WD	68	4A90		06/10-	VFKH16	5654	1.1	-	IKH16TT	IKH16TT	4
1.3 4WD	68	4A90		10/04-	VKH20	5618	1.1	-	IKH20TT	IKH20TT	4
1.3 Bifuel	70	4A90		06/10-06/12	VFKH16	5654	1.1	-	IKH16TT	IKH16TT	4
1.3 Bifuel	70	4A90		06/04-06/12	VKH20	5618	1.1	-	IKH20TT	IKH20TT	4
1.5	80	4A91		06/04-06/12	K20HR-U11	3381	1.1	KH20TT	IKH20TT	IKH20TT	4
1.5	80	4A91	OEM Optional	06/04-06/12	VKH20	5618	1.1	-	IKH20TT	IKH20TT	4
1.5 (Z23)	77	4A91; 4G91		07/06-	K20HR-U11	3381	1.1	KH20TT	IKH20TT	IKH20TT	4
1.5 (Z27)	72	4G15 (16V)		09/04-02/06	K16HR-U11	3482	1.1	KH16TT	IKH16TT	IKH16TT	4
1.5 4WD	77	4A91		07/06-	K20HR-U11	3381	1.1	KH20TT	IKH20TT	IKH20TT	4
1.5 CZT	110	4G15T		03/05-06/12	IKH20	5344	1.1	-	IKH20TT	IKH20TT	4
1.5 DI-D	50/70	OM 639.939		08/04-06/12	DG-606		11.5V				3
1.5 Ralliart R	120	4G15T		02/10-	IKH20	5344	1.1	-	IKH20TT	IKH20TT	4
1.5 Turbo (Z23)	113	4G15T		09/06-	IKH20	5344	1.1	-	IKH20TT	IKH20TT	4
CORDIA (82-89)											
1.6 GSL (A212A)	55	4G32		10/82-12/86	W20EP-U	3043	0.8	W20TT	IW20TT	IW20TT	4
1.6 Turbo (A212A)	84/85	4G32 T		10/82-05/85	W20EPR-U	3047	0.8	W20TT	IW20TT	IW20TT	4
1.8 Turbo Eci (A213A)	100	4G62 T		10/84-12/86	W22ESR-U	3098	0.8	-	-	-	4

	KW								QTY		
MITSUBISHI <i>continued</i>											
DEBONAIR (92-97)											
3.0	125	6G72 (SOHC 12V)		09/92-10/97	P20PR11	3115	1.1	W20TT	IW20TT	IW20TT	6
DELICA (07-)											
1.2	67	K12B		05/11-	ZXU20PR11	3452	1.1	-	-	VXU22	4
1.2 4WD	67	K12B		05/11-	ZXU20PR11	3452	1.1	-	-	VXU22	4
2.4 4WD	125	4B12		06/07-12/09	K16PSR-B8	3437	0.8	-	IK16TT	IK16TT	4
2.4 4WD	125	4B12		12/09-	VFK16		1.1	-	IK16TT	IK16TT	4
ECLIPSE I (89-95)											
1.8 (D21A)	68	4G37		12/89-03/94	W20EPR-U11	3049	1.1	W20TT	IW20TT	IW20TT	4
2.0 i 16V (D22A, D27A)	110	4G63 (DOHC 16V)		04/91-11/95	W20EPR-U	3047	0.8	W20TT	IW20TT	IW20TT	4
2.0 i 16V 4WD (D22A, D27A)	110	4G63 (DOHC 16V)		04/91-11/95	W20EPR-U	3047	0.8	W20TT	IW20TT	IW20TT	4
2.0 Turbo	147	4G63 T (DOHC 16V)		12/89-03/94	W20EPR-U	3047	0.8	W20TT	IW20TT	IW20TT	4
ECLIPSE II (94-99)											
2000 GS 16V (D32A)	107	4 G 63		12/95-04/99	W20EPR-U	3047	0.8	W20TT	IW20TT	IW20TT	4
2000 GT 16V	157	4G63-7L		12/95-04/99	W20EPR-U11	3049	1.1	W20TT	IW20TT	IW20TT	4
2000 GT 16V	157	4G63-7L	OEM Optional	12/95-04/99	W22EPR-U	3088	0.8	W22TT	-	VW22	4
ECLIPSE IV (05-11)											
2.4 GS	120	4G69		04/05-12/11	IKH20	5344	1.1	-	IKH20TT	IKH20TT	4
eK (00-)											
0.7	37	3G83 (SOHC 12V)		10/00-	KJ20CR-U11	3451	1.1	K20TT	IK20TT	IK20TT	3
0.7	47	3G83 T (SOHC 12V)		09/06-	VK20Y	5620	0.8	-	-	VK20Y	3
0.7 4WD	37	3G83 (SOHC 12V)		10/00-	KJ20CR-U11	3451	1.1	K20TT	IK20TT	IK20TT	3
0.7 4WD	47	3G83 T (SOHC 12V)		09/06-	VK20Y	5620	0.8	-	-	VK20Y	3
GALANT I (77-80)											
1.6	55	4G32		01/77-08/80	W20EP-U	3043	0.8	W20TT	IW20TT	IW20TT	4
2.0	72	4G52		01/79-08/80	W20EP-U	3043	0.8	W20TT	IW20TT	IW20TT	4
GALANT II (80-84)											
1.6 GLX (A161A)	55	4G32		09/80-05/84	W16EPR-U	3021	0.8	W16TT	IW16TT	IW16TT	4
2.0 GLS (A163)	75	4G63		09/80-05/84	W20EPR-U	3047	0.8	W20TT	IW20TT	IW20TT	4
2.0 Turbo ECi (A164)	125	4 G 63 T (ECi)		05/82-05/84	W22ESR-U	3098	0.8	-	-	-	4
2.3 Turbo-D (A167)	62	4D55 T		09/80-05/84	DG-162		6V				4
2.3 Turbo-D (A167)	62	4D55 T		09/80-05/84	DG-198		11V				4
2.3 Turbo-D (A167V)	62	4D55 T		07/83-05/84	DG-162		6V				4
2.3 Turbo-D (A167V)	62	4D55 T		07/83-05/84	DG-198		11V				4
GALANT III (84-90)											
1.6 GLX (E11A)	55	4G32		06/84-04/90	W16EPR-U	3021	0.8	W16TT	IW16TT	IW16TT	4
1.8 Turbo-D (E14A)	60	4D65 T		06/84-04/90	DG-198		11V				4
2.0 GLS (E15A)	75	4G63		06/84-04/90	W20EPR-U	3047	0.8	W20TT	IW20TT	IW20TT	4
2.0 GLS (E15A)	66	G63B		06/86-04/90	W20EPR-U11	3049	1.1	W20TT	IW20TT	IW20TT	4
2.0 Turbo ECi (E15A)	110	4 G 63 T		06/84-04/90	W22ESR-U	3098	0.8	-	-	-	4
2.4 GLS (E16A)	82	G64B		07/85-04/90	W20EPR-U11	3049	1.1	W20TT	IW20TT	IW20TT	4
GALANT IV (87-92)											
1.6 (E31A)	55	4G32		01/88-10/92	W20EPR-U	3047	0.8	W20TT	IW20TT	IW20TT	4
1.8 (E32A)	66	4G37		11/87-10/92	W20EPR-U	3047	0.8	W20TT	IW20TT	IW20TT	4
1.8 (E32A)	63	4G37		11/87-08/90	W20EPR-U11	3049	1.1	W20TT	IW20TT	IW20TT	4
1.8 Turbo-D (E34A)	55	4D65 T		12/87-10/92	DG-198		11V				4
2.0 (E39A, E38A, E33A)	80	4G63		11/87-10/92	W20EPR-U	3047	0.8	W20TT	IW20TT	IW20TT	4
2.0 4WD (E33A, E38A, E39A)	80	4G63		04/89-10/92	W20EPR-U	3047	0.8	W20TT	IW20TT	IW20TT	4
2.0 4WD (E39A, E38A, E33A)	80	4G63		12/88-10/92	W20EPR-U	3047	0.8	W20TT	IW20TT	IW20TT	4
2.0 GTi 16V (E39A, E38A, E33A)	106/107	4 G 63; 4G63 (DOHC 16V)		11/87-10/92	W20EPR-U	3047	0.8	W20TT	IW20TT	IW20TT	4
2.0 GTi 16V 4WD (E39A, E38A, E33A)	106	4 G 63		06/88-10/92	W20EPR-U	3047	0.8	W20TT	IW20TT	IW20TT	4
2.0 GTi 16V 4x4 (E38A, E39A, E33A)	106	4G63 (DOHC 16V)		07/89-12/92	W20EPR-U	3047	0.8	W20TT	IW20TT	IW20TT	4
GALANT V (92-96)											
1.8 (E52A)	85	4G93		02/94-08/96	K16PR-U11	3130	1.1	K16TT	IK16TT	IK16TT	4
1.8 (E52A)	85	4G93		02/94-08/96	K20PR-U11	3121	1.1	K20TT	IK20TT	IK20TT	4
1.8 GLSi (E52A)	93	4G93		11/92-08/96	K20PR-U11	3121	1.1	K20TT	IK20TT	IK20TT	4
2.0 (E55A, E75A)	90	4G63		04/93-03/95	W20EPR-U	3047	0.8	W20TT	IW20TT	IW20TT	4
2.0 GLSi (E55A)	101	4G63		11/92-08/96	W20EPR-U	3047	0.8	W20TT	IW20TT	IW20TT	4
2.0 GLSi 4WD (E75A)	101	4G63		11/92-08/96	W20EPR-U	3047	0.8	W20TT	IW20TT	IW20TT	4
2.0 GLSTD (E57A)	66	4D68 T		11/92-08/96	DG-174		11V				4
2.0 V6-24 (E64A, E54A)	110	6A12		11/92-08/96	K20PR-U11	3121	1.1	K20TT	IK20TT	IK20TT	6
2.0 V6-24 (E64A, E54A)	110	6A12		11/92-08/96	PK20PR-P11	3141	1.1	K20TT	IK20TT	IK20TT	6
2.5 V6-24 4WD (E88A)	125	6G73		11/92-08/96	PK20PR-P11	3141	1.1	K20TT	IK20TT	IK20TT	6

Spark & Glow Plugs







Application Tables









	KW					Standard 			Twin Tip 			QTY	
MITSUBISHI <i>continued</i>													
GALANT VI (96-04)													
1.8 GDi	103	4G93 (GDI)		11/97-10/01	VKB20	5625	1.1	-	-	VKB20		4	
2.0 (EA2A)	98/ 100	4G63-6G;4G63-6GR; 4G63-6M, 4G63-6T		09/96-05/03	K20PR-U11	3121	1.1	K20TT	IK20TT	IK20TT		4	
2.0 (EA2W)	98/ 100	4G63-6G;4G63-6GR; 4G63-6T		09/96-09/02	K20PR-U11	3121	1.1	K20TT	IK20TT	IK20TT		4	
2.0 TDI (EA6A)	66	4D68 (SOHC); 4D68 T		09/96-10/04	DG-174		11V					4	
2.0 TDI (EA6W)	66	4D68 (SOHC)		09/96-10/03	DG-174		11V					4	
2.4 GDI (EA3A)	106/ 110	4G64-41;4G64-41R; 4G64-418; 4G64-43		02/99-05/03	VKB16	5624	1.1	-	-	VKB16		4	
2.4 GDI (EA3W)	106/ 110	4G64-41;4G64-41R; 4G64-418; 4G64-43		02/99-10/03	VKB16	5624	1.1	-	-	VKB16		4	
2.5 V6 24V (EA5A)	118/ 120	6A13-41;6A13-48; 6A13-4E;6A13-4F		09/96-05/03	PK20PR11	3168	1.1	K20TT	IK20TT	IK20TT		6	
2.5 V6 24V (EA5W)	118/ 120	6A13-41;6A13-48; 6A13-4E;6A13-4F		09/96-09/02	PK20PR11	3168	1.1	K20TT	IK20TT	IK20TT		6	
GALANT VII (03-)													
2.4	116/ 118	4G69		10/03-	IKH20	5344	1.1	-	IKH20TT	IKH20TT		4	
2.4 GDi Sport (DJ1A)	121	4G69		07/06-07/10	IKH20	5344	1.1	-	IKH20TT	IKH20TT		4	
2.4 GDi Sport 4WD (DJ1A)	121	4G69		10/03-	IKH20	5344	1.1	-	IKH20TT	IKH20TT		4	
GALLOPER (98-03)													
2.5 TD	65	D4BF		09/98-12/03	DG-301		11V					4	
2.5 TD intercooler	73	D4BH		09/98-12/03	DG-301		11V					4	
GRANDIS (04-)													
2.0 DI-D	100	BSY		09/05-05/07	DG-190		4.4V					4	
2.0 DI-D	103	BWC	Particle filter(-)	02/07-	DG-190		4.4V					4	
2.4	121/ 130	4G69		04/04-	IKH20	5344	1.1	-	IKH20TT	IKH20TT		4	
i-MiEV (06-)													
0.7	42	3B20 T		01/06-	SXU22HDR8	3441	0.8	-	-	VXUH22		3	
L 200 (80-86)													
1.6	60	4G32		03/80-08/84	W20EP-U	3043	0.8	W20TT	IW20TT	IW20TT		4	
L 200 (86-96)													
2.0 (K12T, K32T)	75	4G63		11/86-08/96	W20EPR-U	3047	0.8	W20TT	IW20TT	IW20TT		4	
2.0 4WD (K32T, K22T)	75	4G63		11/86-08/96	W20EPR-U	3047	0.8	W20TT	IW20TT	IW20TT		4	
2.5 D (K14T)	51	4D56 (8V)		11/86-10/96	DG-174		11V					4	
2.5 D (K14T)	51	4D56 (8V)		11/86-10/96	DG-198		11V					4	
2.5 D 4WD (K24T)	51	4D56 (8V)		12/87-05/93	DG-174		11V					4	
2.5 D 4WD (K24T)	51	4D56 (8V)		12/87-05/93	DG-198		11V					4	
2.5 TD 4WD (K34T)	64	4D56 T		11/92-08/96	DG-174		11V					4	
2.5 TD 4WD (K34T)	64	4D56 T		11/92-08/96	DG-198		11V					4	
2.6 4WD (K33T)	76	G54B		11/89-05/95	W20EPR-U11	3049	1.1	W20TT	IW20TT	IW20TT		4	
L 200 (96-07)													
2.0 (K62T)	90	4G63-6H		06/96-06/01	K16PR-U11	3130	1.1	K16TT	IK16TT	IK16TT		4	
2.4 4WD (K75T)	97	4G64-2G		06/96-12/07	K16PR-U11	3130	1.1	K16TT	IK16TT	IK16TT		4	
2.4 4WD (K75T)	97	4G64		06/96-11/97	W20EPR-U11	3049	1.1	W20TT	IW20TT	IW20TT		4	
2.5 D (K64T)	55	4D56 (8V)		06/96-12/07	DG-174		11V					4	
2.5 D (K64T)	55	4D56 (8V)		06/96-12/07	DG-301		11V					4	
2.5 TD (K64T)	66	4D56 T		08/01-11/05	DG-174		11V					4	
2.5 TD (K64T)	66	4D56 T		08/01-11/05	DG-301		11V					4	
2.5 TD 4WD (K74T)	73/ 85/ 98	4D56 TD		06/96-12/07	DG-174		11V					4	
2.5 TD 4WD (K74T)	73/ 85/ 98	4D56 TD		06/96-12/07	DG-301		11V					4	
L 300 (80-87)													
1.6 (L032P, L062P)	51	4G32		11/84-02/87	W16EPR-U	3021	0.8	W16TT	IW16TT	IW16TT		4	
1.6 (L032P, L062P)	48/51	4G32		05/80-04/94	W20EP-U	3043	0.8	W20TT	IW20TT	IW20TT		4	
1.6 (L062P, L032P)	51	4G32		02/80-10/86	W16EPR-U	3021	0.8	W16TT	IW16TT	IW16TT		4	
2.3 D (L038P)	50	4D55		04/83-10/86	DG-198		11V					4	
2.3 D (L038P)	50	4D55	QuickGlow System	04/83-10/86	DG-162		6V					4	
2.3 D (L038P, L068P)	50	4D55		09/83-10/86	DG-198		11V					4	
2.3 D (L038P, L068P)	50	4D55	QuickGlow System	09/83-10/86	DG-162		6V					4	
2.5 D (L039P)	51	4D56 (8V)		11/86-04/94	DG-198		11V					4	
L 300 (86-)													
1.6 (P02V, P12V)	51	4G32		11/86-	W16EPR-U	3021	0.8	W16TT	IW16TT	IW16TT		4	
1.6 (P12V, P02V)	51	4G32		11/86-05/94	W16EPR-U	3021	0.8	W16TT	IW16TT	IW16TT		4	
2.0 (P03V, P13V)	64	G63B		11/86-09/13	W20EPR-U11	3049	1.1	W20TT	IW20TT	IW20TT		4	







	KW					Standard		Twin Tip		QTY	
MITSUBISHI <i>continued</i>											
L 300 (86-) continued											
2.0 (P13T, P03W, P03V, P13V)	66	4G63		11/86-	W20EPR-U	3047	0.8	W20TT	IW20TT	IW20TT	4
2.0 (P13V, P03W, P13T)	64	G63B		11/86-	W20EPR-U	3047	0.8	W20TT	IW20TT	IW20TT	4
2.0 (P23W, P23V)	82	4G63		06/94-05/02	W20EPR-U	3047	0.8	W20TT	IW20TT	IW20TT	4
2.0 4WD (P13V, P23V, P23W, P03V, P13T)	65	4G63		12/86-	W20EPR-U	3047	0.8	W20TT	IW20TT	IW20TT	4
2.0 4WD (P13V, P23W, P03V, P13T)	66	4G63		11/86-	W20EPR-U	3047	0.8	W20TT	IW20TT	IW20TT	4
2.0 i (P13V, P00W, P03V, P03W, P13T)	83	4G63		07/96-08/97	K16PR-U11	3130	1.1	K16TT	IK16TT	IK16TT	4
2.4 (P04W, P14V, P04V)	82	4G64 (8V)		11/90-	P22PR8	3302	0.8	-	-	VW22	4
2.4 4WD (P24W, P24V)	80	G64B		11/86-12/90	W20EPR-U11	3049	1.1	W20TT	IW20TT	IW20TT	4
2.5 D (P05V, P05W, P15V)	51	4D56 (8V)		11/86-02/06	DG-174		11V				4
2.5 D (P05V, P05W, P15V)	51	4D56 (8V)		11/86-02/06	DG-198		11V				4
2.5 D (P25V, P05W, P05V, P15V, P15T)	51	4D56 (8V)		11/86-	DG-174		11V				4
2.5 D (P25V, P05W, P05V, P15V, P15T)	51	4D56 (8V)		11/86-	DG-198		11V				4
2.5 TD 4WD (P25W, P25V)	64	4D56 T		11/88-	DG-174		11V				4
2.5 TD 4WD (P25W, P25V)	64	4D56 T		11/88-	DG-198		11V				4
L 300 (94-00)											
2.0	83	4G63 (DOHC 16V)		06/94-04/00	W20EPR-U	3047	0.8	W20TT	IW20TT	IW20TT	4
2.0 (P13T)	85	4G63 (DOHC 16V)		07/94-04/00	W20EPR-U	3047	0.8	W20TT	IW20TT	IW20TT	4
2.5 TD (P15T)	64	4D56 T		11/94-04/00	DG-174		11V				4
L 400 / SPACE GEAR (95-05)											
2.0	83	4G63 (DOHC 16V)		09/95-10/02	W20EPR-U	3047	0.8	W20TT	IW20TT	IW20TT	4
2.0 16V (PA3V/W, PB3V)	85	4G63 (DOHC 16V)		05/95-05/00	W20EPR-U	3047	0.8	W20TT	IW20TT	IW20TT	4
2.4	97	4G64-2		06/96-01/01	K16PR-U11	3130	1.1	K16TT	IK16TT	IK16TT	4
2.4 i 4WD (PD4V/W)	97	4G64-2		05/95-11/98	K16PR-U11	3130	1.1	K16TT	IK16TT	IK16TT	4
2.5 TD (PA5V/W, PB5V)	73	4D56 TD		05/95-05/00	DG-174		11V				4
2.5 TD 4WD (PD5V/W)	73	4D56 TD		05/95-05/00	DG-174		11V				4
2500 TD	64	4D56 T		05/95-06/05	DG-174		11V				4
2500 TD	64	4D56 T		05/95-03/01	DG-301		11V				4
2500 TD (PD5W, PD5V, PA5W, PA5V)	64	4D56 T		09/96-06/05	DG-174		11V				4
2500 TD (PD5W, PD5V, PA5W, PA5V)	64	4D56 T		09/96-03/01	DG-301		11V				4
2500 TD 4WD (PD5W, PD5V, PA5W, PA5V)	64	4D56 T		09/96-06/05	DG-174		11V				4
2500 TD 4WD (PD5W, PD5V, PA5W, PA5V)	64	4D56 T		09/96-03/01	DG-301		11V				4
LANCER (07-)											
1.5	80	4A91		06/08-06/10	IKH20	5344	1.1	-	IKH20TT	IKH20TT	4
1.6	86	4A92		05/10-	VFKH16	5654	1.1	-	IKH16TT	IKH16TT	4
1.8	105	4B10(143)		02/08-	K20PSR-B8	3431	0.8	-	IK20TT	IK20TT	4
1.8	103	4B10		05/10-	SK20PR-A8	3403	0.8	-	IK20TT	IK20TT	4
1.8	105	4B10(143)	OEM Optional	02/08-	SK20PR-A8	3403	0.8	-	IK20TT	IK20TT	4
1.8 (CX3A)	105	4B10(143)		06/08-	K20PSR-B8	3431	0.8	-	IK20TT	IK20TT	4
1.8 (CX3A)	105	4B10(143)	OEM Optional	06/08-	SK20PR-A8	3403	0.8	-	IK20TT	IK20TT	4
1.8 Bifuel	105	4B10		02/10-	SK20PR-A8	3403	0.8	-	IK20TT	IK20TT	4
1.8 Flex	103	4B10		03/09-	SK20PR-A8	3403	0.8	-	IK20TT	IK20TT	4
2.0 DI-D	103	BKD; BWC	Particle filter(-)	01/08-	DG-190		4.4V				4
2.0 Ralliart 4WD (CX4A)	177	4B11 T/C		10/08-06/10	GX8-1	3462	0.8	-	-	-	4
LANCER EVO (92-)											
2.0 16V EVO	206	4G63-7TC		08/98-12/00	P22PR8	3302	0.8	-	-	VW22	4
2.0 16V EVO	206	4G63 Turbo		01/01-08/01	S22PR-A7	3354	0.7	-	-	VW22	4
2.0 16V EVO IX (CT9A)	206	4G63 Turbo		01/06-07/10	VKH22	5619	0.8	-	-	VKH22	4
2.0 16V EVO VIII (CT9A)	195	4G63 Turbo		03/04-07/05	P22PR8	3302	0.8	-	-	VW22	4
2.0 16V EVO VIII (CT9A)	195	4G63 Turbo		07/05-	S22PR-A7	3354	0.7	-	-	VW22	4
2.0 4WD	213	4G63 Turbo		08/05-07/10	VKH22	5619	0.8	-	-	VKH22	4
2.0 EVO	221/ 242/ 264	4B11 T/C; 4B11FQ30; 4B11FQ60		06/08-09/10	GX8-1	3462	0.8	-	-	-	4
2.0 EVO 4WD (CZ4A)	217	4B11 T/C		06/08-09/10	GX8-1	3462	0.8	-	-	-	4
2.0 EVO I (CD9A)	182	4G63 Turbo		10/92-12/93	W22EPR-U	3088	0.8	W22TT	-	VW22	4
2.0 EVO II (CE9A)	192	4G63 Turbo		01/94-07/95	W22EPR-U	3088	0.8	W22TT	-	VW22	4
2.0 EVO III (CE9A)	198	4G63 Turbo		08/95-07/96	W22ETR-L	3315	1.0	-	-	VW22	4
2.0 i Ralliart 4WD (CY4A)	177	4B11 T/C		10/08-09/10	GX8-1	3462	0.8	-	-	-	4
LANCER I (79-83)											
1.2 (A171)	40	4 G 11		01/80-12/81	W16EPR-U	3021	0.8	W16TT	IW16TT	IW16TT	4
1.4 GLX (A172)	50	4 G 12		09/79-02/83	W16EPR-U	3021	0.8	W16TT	IW16TT	IW16TT	4







Spark & Glow Plugs







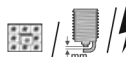

Application Tables

	KW				 Standard			 Twin Tip			 QTY
MITSUBISHI <i>continued</i>											
LANCER I (79-83) <i>continued</i>											
1.6 (A174)	62	4G32 GS		01/81-02/83	W16EPR-U	3021	0.8	W16TT	IW16TT	IW16TT	4
2.0 Turbo ECi (A176)	125	4G63 T (SOHC 8V)		03/81-02/83	W20EPR-U	3047	0.8	W20TT	IW20TT	IW20TT	4
LANCER II (83-84)											
1.2 GLX (A171)	40	4 G 11		03/83-01/84	W16EPR-U	3021	0.8	W16TT	IW16TT	IW16TT	4
1.4 GLX (A172)	51	4 G 12		03/83-01/84	W16EPR-U	3021	0.8	W16TT	IW16TT	IW16TT	4
LANCER III (83-92)											
1.2 (C65A)	44	4G16		08/86-04/88	W20EPR-U	3047	0.8	W20TT	IW20TT	IW20TT	4
1.2 GL (C15AS)	40	4G16		01/84-10/86	W20EPR-U	3047	0.8	W20TT	IW20TT	IW20TT	4
1.5 (C12V)	55	4 G 15		09/85-12/87	K20PR-U11	3121	1.1	K20TT	IK20TT	IK20TT	4
1.5 (C12V)	51	G15B		09/85-08/89	W20EPR-U11	3049	1.1	W20TT	IW20TT	IW20TT	4
1.5 12V (C12V)	66	4G15 (12V)		09/90-12/91	W20EPR-U	3047	0.8	W20TT	IW20TT	IW20TT	4
1.5 GLX (C12AS)	55	4 G 15		11/83-04/88	K20PR-U11	3121	1.1	K20TT	IK20TT	IK20TT	4
1.8 4WD (C37V)	61/ 63/ 66/ 69	4G37; G37B		01/87-06/92	W20EPR-U11	3049	1.1	W20TT	IW20TT	IW20TT	4
1.8 D (C14V)	44	4D65		08/86-06/92	DG-301		11V				4
1.8 Diesel (C14AS)	44	4D65		09/86-04/88	DG-198		11V				4
1.8 Diesel (C14AS)	43	4D65		01/84-09/86	DG-301		11V				4
LANCER IV (88-94)											
1.3 (C61A)	44	4 G 13		04/88-05/92	W20EPR-U	3047	0.8	W20TT	IW20TT	IW20TT	4
1.3 (C61A)	51	G13B		08/88-05/92	W20EPR-U11	3049	1.1	W20TT	IW20TT	IW20TT	4
1.3 12V (C61A)	55	4 G 13 (12V); 4G13-ESI		07/90-05/94	W16EPR-U11	3201	1.1	W16TT	IW16TT	IW16TT	4
1.3 12V (C61A)	55	4G13-ESI		07/90-04/91	W20EPR-U11	3049	1.1	W20TT	IW20TT	IW20TT	4
1.5 (C62A)	62	4 G 15		04/88-05/92	K20PR-U11	3121	1.1	K20TT	IK20TT	IK20TT	4
1.5 12V (C62A)	66	4G15 (12V)		05/89-05/92	IW20	5306	1.1	-	IW20TT	IW20TT	4
1.5 12V (C62A)	66	4G15 (12V)		05/89-05/92	W20EPR-U11	3049	1.1	W20TT	IW20TT	IW20TT	4
1.6 16V (C76A, C66A)	83	4G92		06/92-05/94	K20PR-U11	3121	1.1	K20TT	IK20TT	IK20TT	4
1.6 4WD (C76A, C66A)	84	4G92		06/92-11/93	K20PR-U11	3121	1.1	K20TT	IK20TT	IK20TT	4
1.6 GLX	91	4G61		08/89-08/92	W20EPR-U	3047	0.8	W20TT	IW20TT	IW20TT	4
1.6 GTi	91	4G61		05/88-05/90	W20EPR-U	3047	0.8	W20TT	IW20TT	IW20TT	4
1.6 GTi (C63A)	91	4G61		05/88-05/90	W20EPR-U	3047	0.8	W20TT	IW20TT	IW20TT	4
1.6 i (C63A)	90	4G61		09/90-09/92	W20EPR-U	3047	0.8	W20TT	IW20TT	IW20TT	4
1.8 4WD (C77A)	71	4G37		09/89-06/92	W20EPR-U11	3049	1.1	W20TT	IW20TT	IW20TT	4
1.8 D (C64A)	44	4D65		04/88-05/92	DG-301		11V				4
1.8 GLX Diesel (C64A)	44	4D65		04/88-05/92	DG-301		11V				4
1.8 GTi 16V (C68A)	100	4G67		11/89-05/92	W20EPR-U	3047	0.8	W20TT	IW20TT	IW20TT	4
1.8 GTi 16V (C69A)	103	4G93		06/92-12/93	K20PR-U11	3121	1.1	K20TT	IK20TT	IK20TT	4
2.0 D (C67A)	50	4D68		06/92-07/93	DG-301		11V				4
LANCER V (91-03)											
1.3 (CB1A)	55	4G13-2J		06/92-12/96	W16EPR-U11	3201	1.1	W16TT	IW16TT	IW16TT	4
1.6	103			09/92-07/96	K20PR-U11	3121	1.1	K20TT	IK20TT	IK20TT	4
1.6 (CB4A)	66	4G92		02/94-12/96	K20PR-U11	3121	1.1	K20TT	IK20TT	IK20TT	4
1.6 (CB4A)	66	4G92 MVV	LEAN BURN	02/94-12/96	K16PR-U11	3130	1.1	K16TT	IK16TT	IK16TT	4
1.6 16V (CB4A)	83	4G92		06/92-12/96	K20PR-U11	3121	1.1	K20TT	IK20TT	IK20TT	4
1.6 16V (CB4A)	83	4G92 MVV	LEAN BURN	12/93-12/96	K16PR-U11	3130	1.1	K16TT	IK16TT	IK16TT	4
1.6 16V (CB4A)	83	4G92 MVV	LEAN BURN	06/92-11/93	K20PR-U11	3121	1.1	K20TT	IK20TT	IK20TT	4
1.6 16V (CB4W)	83	4G92		12/92-10/03	K20PR-U11	3121	1.1	K20TT	IK20TT	IK20TT	4
1.6 16V (CB4W)	83	4G92 MVV	LEAN BURN	12/93-10/03	K16PR-U11	3130	1.1	K16TT	IK16TT	IK16TT	4
1.6 16V (CB4W)	83	4G92 MVV	LEAN BURN	12/92-11/93	K20PR-U11	3121	1.1	K20TT	IK20TT	IK20TT	4
1.6 16V 4WD (CD4A)	83	4G92		06/92-12/96	K20PR-U11	3121	1.1	K20TT	IK20TT	IK20TT	4
1.6 16V 4WD (CD4A)	83	4G92 MVV	LEAN BURN	12/93-12/96	K16PR-U11	3130	1.1	K16TT	IK16TT	IK16TT	4
1.6 16V 4WD (CD4A)	83	4G92 MVV	LEAN BURN	06/92-11/93	K20PR-U11	3121	1.1	K20TT	IK20TT	IK20TT	4
1.6 16V 4WD (CD4W)	83	4G92		12/92-10/03	K20PR-U11	3121	1.1	K20TT	IK20TT	IK20TT	4
1.6 16V 4WD (CD4W)	83	4G92 MVV	LEAN BURN	12/93-10/03	K16PR-U11	3130	1.1	K16TT	IK16TT	IK16TT	4
1.6 16V 4WD (CD4W)	83	4G92 MVV	LEAN BURN	12/92-11/93	K20PR-U11	3121	1.1	K20TT	IK20TT	IK20TT	4
1.8 16V (CB5A)	103	4G93-1		06/92-12/93	K20PR-U11	3121	1.1	K20TT	IK20TT	IK20TT	4
2.0 D (CB8W)	50	4D68		12/92-10/03	DG-174		11V				4
2.0 Diesel (CB8A)	50	4D68		06/92-12/96	DG-174		11V				4
LANCER VI (95-03)											
1.3 12V (CK1A)	55	4G13-38		12/95-01/00	W16EPR-U11	3201	1.1	W16TT	IW16TT	IW16TT	4
1.5 16V (CK2A)	69	4G15-5		12/95-01/00	W16EPR-U11	3201	1.1	W16TT	IW16TT	IW16TT	4
1.6 16V (CK4A)	66	4G92		12/95-08/03	K20PR-U11	3121	1.1	K20TT	IK20TT	IK20TT	4
1.6 16V (CK4A)	66	4G92 MVV	LEAN BURN	12/95-05/99	K16PR-U11	3130	1.1	K16TT	IK16TT	IK16TT	4
1.6 16V (CK4A)	66	4G92 MVV	LEAN BURN	06/99-08/03	K20PR-U11	3121	1.1	K20TT	IK20TT	IK20TT	4
LANCER VII (03-)											
1.3	60	4G13-6		09/03-	K20PR-U11	3121	1.1	K20TT	IK20TT	IK20TT	4

	KW					Standard			Twin Tip			QTY
MITSUBISHI <i>continued</i>												
LANCER VII (03-) <i>continued</i>												
1.6	72	4G18-6		09/03-06/08	K20PR-U11	3121	1.1	K20TT	IK20TT	IK20TT		4
1.6 (CS3A)	72	4G18-6		09/03-	K20PR-U11	3121	1.1	K20TT	IK20TT	IK20TT		4
2.0	85/99	4G63 (DOHC 16V)		09/03-	VW20	5606	1.1	-	IW20TT	IW20TT		4
2.0 (CS9A)	99	4G63 (DOHC 16V)		12/03-	VW20	5606	1.1	-	IW20TT	IW20TT		4
2.4 iVRX	115	4G69		08/05-	IKH20	5344	1.1	-	IKH20TT	IKH20TT		4
MAGNA (96-05)												
3.0	150	6G72 (SOHC 24V)		08/00-07/02	PK16PR-P11	3174	1.1	K16TT	IK16TT	IK16TT		6
3.0 GDi	158	6G72 (DOHC 24V)		06/98-05/03	PK16PR-P11	3174	1.1	K16TT	IK16TT	IK16TT		6
3.0 i	140	6G72 (SOHC 24V)		04/96-07/02	PK16PR-P11	3174	1.1	K16TT	IK16TT	IK16TT		6
MIRAGE (88-91)												
1.6 Gti	92	4G61		06/88-11/91	W20EPR-U	3047	0.8	W20TT	IW20TT	IW20TT		4
OUTLANDER I (03-06)												
2.0 (CU2W)	100	4G63 (DOHC 16V)		05/03-10/06	VW20	5606	1.1	-	IW20TT	IW20TT		4
2.0 4WD (CU2W)	93/ 100	4G63 (DOHC 16V); 4G63-7T3		05/03-10/06	VW20	5606	1.1	-	IW20TT	IW20TT		4
2.0 Turbo 4WD (CU2W)	148	4G63 T (DOHC 16V)		04/04-10/06	VW22	5607	0.8	-	-	VW22		4
2.4 4WD	102	4G64 (SOHC 16V)		05/03-10/06	IKH20	5344	1.1	-	IKH20TT	IKH20TT		4
2.4 4WD (CU5W)	118/ 119	4G69		05/03-10/06	IKH20	5344	1.1	-	IKH20TT	IKH20TT		4
2.4 HDD Mivec (CU5W)	118	4G69		03/01-12/06	IKH20	5344	1.1	-	IKH20TT	IKH20TT		4
OUTLANDER II (06-12)												
2.0	108/ 118	4B11		11/06-	VFK20F			-	IK20TT	IK20TT		4
2.0 4WD	108	4B11		11/06-11/12	VFK20F			-	IK20TT	IK20TT		4
2.0 DI-D	103	BSY		12/06-11/12	DG-190		4.4V					4
2.2 DI-D	130	4N14		11/06-11/12	DG-614		11V					4
2.2 DI-D 4WD	103/ 115/ 130	4HK; 4HN; 4N14		11/06-11/12	DG-614		11V					4
2.4	125	4B12		11/06-06/10	K16PSR-B8	3437	0.8	-	IK16TT	IK16TT		4
2.4 4WD	125	4B12		09/07-06/10	K16PSR-B8	3437	0.8	-	IK16TT	IK16TT		4
2.4 Flex 4WD	125	4B12		09/07-06/10	K16PSR-B8	3437	0.8	-	IK16TT	IK16TT		4
3.0 4WD	162/ 177	6B31		11/06-	SXU22HDR8	3441	0.8	-	-	VXUH22		6
3.0 FWD	162	6B31		11/06-	SXU22HDR8	3441	0.8	-	-	VXUH22		6
OUTLANDER III (12-)												
2.0	118	4B11		09/13-	K20PSR-B8	3431	0.8	-	IK20TT	IK20TT		4
2.0	107/ 110	4J11	Europe	08/12-	IXUH20I			-	-	VXUH20I		4
2.0	107/ 110	4J11	Russia	08/12-	K20PSR-B8	3431	0.8	-	IK20TT	IK20TT		4
2.0 4WD	107/ 110	4J11	Europe	08/12-	IXUH20I			-	-	VXUH20I		4
2.0 4WD	107/ 110	4J11	Russia	08/12-	K20PSR-B8	3431	0.8	-	IK20TT	IK20TT		4
2.4 4WD	124	4J12		10/12-	K16PSR-B8	3437	0.8	-	IK16TT	IK16TT		4
PAJERO Classic (02-)												
2.5 TD	85	4D56 T		07/02-	DG-174		11V					4
3.2 DI-D	118	4M41		05/05-	DG-187		11V					4
PAJERO I (82-91)												
2.3 TD (L043G, L048G)	62	4D55 T		12/82-04/86	DG-198		11V					4
2.5 TD (L044G, L049G)	62/ 64/ 70	4D56 T		05/86-11/90	DG-198		11V					4
2.6 (L042G, L047G)	76	4G54		01/83-11/90	W16EPR-U	3021	0.8	W16TT	IW16TT	IW16TT		4
2.6 4WD (L042G)	79	4G54-1G		10/86-05/91	W16EPR-U	3021	0.8	W16TT	IW16TT	IW16TT		4
3.0 i 4WD	105	6G72		05/88-05/91	W16EPR-U11	3201	1.1	W16TT	IW16TT	IW16TT		6
3.0 V6 (L141G, L146G)	104	6G72		11/88-11/90	PK20PR-P11	3141	1.1	K20TT	IK20TT	IK20TT		6
PAJERO II (90-00)												
1.8 GDI	96	4G93 (GDI)		06/98-04/00	VKB20	5625	1.1	-	-	VKB20		4
2.4 (V21W, V21C)	82	4G64		04/91-10/99	K16PR-U11	3130	1.1	K16TT	IK16TT	IK16TT		4
2.4 (V41W, V21W, V21C)	82	4G64		04/91-04/00	K16PR-U11	3130	1.1	K16TT	IK16TT	IK16TT		4
2.5 TD 4WD (V24C, V24W)	73	4D56 TD		10/93-04/00	DG-174		11V					4
2.5 TD 4WD (V24C, V24W)	73	4D56 TD		12/90-10/93	DG-198		11V					4
2.5 TDiC (V24W, V24C)	73	4D56 T		10/93-08/99	DG-174		11V					4
2.5 TDiC (V24W, V24C)	73	4D56 T		03/91-10/93	DG-198		11V					4
2.5 TDiC (V44W, V24W)	73	4D56 T		10/93-08/99	DG-174		11V					4
2.5 TDiC (V44W, V24W)	73	4D56 T		03/91-10/93	DG-198		11V					4
2.8 TD (V46W)	92	4M40-T		06/94-10/99	DG-306		11V					4
3.0 V6 (V23W, v43W, V23C)	110	6G72 (SOHC 12V)		12/90-12/95	W16EPR-U11	3201	1.1	W16TT	IW16TT	IW16TT		6
3.0 V6 24V (V23W, V23C)	133	6G72 (SOHC 24V)		06/94-04/00	PK16PR-P11	3174	1.1	K16TT	IK16TT	IK16TT		6







	KW					Standard			Twin Tip				QTY	
MITSUBISHI <i>continued</i>														
PAJERO II (90-00) <i>continued</i>														
3.0 V6 24V (V43W, V23W)	130/133	6G72 (SOHC 24V)		06/94-10/99	PK16PR-P11	3174	1.1		K16TT	IK16TT	IK16TT		6	
3.0 V6 4WD (V23W, V43W, V23C)	110	6G72 (SOHC 12V)		12/90-12/95	W16EPR-U11	3201	1.1		W16TT	IW16TT	IW16TT		6	
3.5 V6 24V (V25W, V45W)	153	6G74 DOHC		06/94-10/99	PK16PR-P11	3174	1.1		K16TT	IK16TT	IK16TT		6	
3.5 V6 24V (V45W, V25W)	143	6G74		07/97-10/99	PK16PR-P11	3174	1.1		K16TT	IK16TT	IK16TT		6	
PAJERO III (00-07)														
2.5 TDi	73/85	4D56 T		04/00-12/06	DG-174		11V						4	
2.5 TDi (V64W, V74W)	73/85	4D56 T		04/00-12/06	DG-174		11V						4	
3.0 (V73W)	125	6G72 (SOHC 24V)		10/01-12/06	PK16PR-P11	3174	1.1		K16TT	IK16TT	IK16TT		6	
3.2 DI-D	118/121	4M41		04/00-12/06	DG-187		11V						4	
3.2 DI-D (V68W, V78W)	118/121	4M41		04/00-12/06	DG-187		11V						4	
3.5	149	6G74 (DOHC 24V)		04/00-01/07	VKA16	5622	1.1	-	-	-	VKA16		6	
3.5 i	160	6G74 (DOHC 24V)		09/03-10/06	VKA16	5622	1.1	-	-	-	VKA16		6	
3.5 V6 GDI (V65W, V75W)	149	6G74 (DOHC 24V)		04/00-12/06	VKA16	5622	1.1	-	-	-	VKA16		6	
PAJERO IV (06-)														
3.0 4WD	131	6G72 (SOHC 24V)		01/10-	VFK20F				-	IK20TT	IK20TT		6	
3.0 4WD	131	6G72 (SOHC 24V)		02/07-12/09	VK20Y	5620	0.8	-	-	-	VK20Y		6	
3.8 V6	182	6G75		02/10-	SK20PR-A8	3403	0.8	-	-	IK20TT	IK20TT		6	
3.8 V6 (V87W, V97W)	184	6G75		02/07-	SK20PR-A8	3403	0.8	-	-	IK20TT	IK20TT		6	
PAJERO Mini (94-12)														
0.7	38	4A30		09/02-08/12	VXU22	5608	0.9	-	-	-	VXU22		4	
0.7	37/38	4A30		10/94-08/02	XU22EPR-U	3179	0.9	XU22TT	-	-	VXU22		4	
0.7 4WD	38/47	4A30; 4A30T		09/02-08/12	VXU22	5608	0.9	-	-	-	VXU22		4	
0.7 4WD	37/38/47	4A30; 4A30T		10/94-08/02	XU22EPR-U	3179	0.9	XU22TT	-	-	VXU22		4	
1.1 4WD	55	4A31		09/02-08/12	VXU22	5608	0.9	-	-	-	VXU22		4	
1.1 4WD	55	4A31		10/95-08/02	XU22EPR-U	3179	0.9	XU22TT	-	-	VXU22		4	
PAJERO Pinin (99-07)														
1.8 (H76W, H66W)	84	4G93-D		11/01-02/05	K16PR-U11	3130	1.1		K16TT	IK16TT	IK16TT		4	
1.8 GDI (H66W)	88	4G93-H		10/99-01/05	VKB20	5625	1.1	-	-	-	VKB20		4	
2.0 GDI (H67W, H77W)	95	4G94-H		10/00-02/05	VKB16	5624	1.1	-	-	-	VKB16		4	
PAJERO Sport I (97-)														
2.5 TD (K94W)	73/85/98	4D56 T		11/98-	DG-174		11V						4	
2.8 TDi	92	4M40-T		11/98-10/03	DG-306		11V						4	
3.0 V6	125	6G72 (DOHC 24V)		12/99-01/08	PK16PR-P11	3174	1.1		K16TT	IK16TT	IK16TT		6	
3.0 V6 (K96W)	123/125/130	6G72 (DOHC 24V); 6G72 (SOHC 24V)		11/98-	PK16PR-P11	3174	1.1		K16TT	IK16TT	IK16TT		6	
SANTAMO (99-04)														
2.0 16V	102	I4-DOHC		05/99-12/01	W20EPR-U11	3049	1.1		W20TT	IW20TT	IW20TT		4	
SAPPORO I (78-80)														
1.6 SL, GL (A121)	55	4G32		04/78-07/80	W20EP-U	3043	0.8		W20TT	IW20TT	IW20TT		4	
SAPPORO II (80-84)														
1.6 GLX (A161A)	55	4G32		08/80-09/84	W20EP-U	3043	0.8		W20TT	IW20TT	IW20TT		4	
SAPPORO III (87-90)														
2.4 (E16A)	91	4G64		06/87-08/90	K16PR-U11	3130	1.1		K16TT	IK16TT	IK16TT		4	
SAVRIN (01-)														
2.4	119	4G69		06/04-	IKH20	5344	1.1	-	-	IKH20TT	IKH20TT		4	
SIGMA (90-96)														
3.0	125	6G721		06/92-01/94	W20EPR-U11	3049	1.1		W20TT	IW20TT	IW20TT		6	
3.0 V6	151	6G72		12/90-07/96	PK20PR-P11	3141	1.1		K20TT	IK20TT	IK20TT		6	
3.0 V6	130	6G72		12/90-07/96	W20EPR-U11	3049	1.1		W20TT	IW20TT	IW20TT		6	
SPACE RUNNER (91-99)														
1.8 (N11W)	85	4G93		06/96-08/99	K20PR-U	3145	0.8		K20TT	IK20TT	IK20TT		4	
1.8 (N11W)	90	4G93		10/91-08/99	K20PR-U11	3121	1.1		K20TT	IK20TT	IK20TT		4	
1.8 4WD (N21W)	85/90	4G93		10/91-08/99	K20PR-U11	3121	1.1		K20TT	IK20TT	IK20TT		4	
2.0 TD (N18W)	60	4D68 T		10/92-08/99	DG-174		11V						4	
SPACE RUNNER (99-02)														
2.0	100	4 G 63		08/99-08/02	K16PR-U	3191	0.8		K16TT	IK16TT	IK16TT		4	
2.4 GDI	110	4G64 (GDI)		08/99-08/02	VKB16	5624	1.1	-	-	-	VKB16		4	
SPACE STAR (98-04)														
1.3 16V (DG1A)	61/63	4G13-16		06/98-05/00	K16PR-U11	3130	1.1		K16TT	IK16TT	IK16TT		4	
1.3 16V (DG1A)	60/63	4G13-16		06/00-12/04	K20PR-U11	3121	1.1		K20TT	IK20TT	IK20TT		4	
1.6	72	4G92		04/01-12/04	K20PR-U11	3121	1.1		K20TT	IK20TT	IK20TT		4	
1.6 16V (DG3A)	72	4G18		01/01-12/04	K20PR-U11	3121	1.1		K20TT	IK20TT	IK20TT		4	

	KW								QTY		
MITSUBISHI <i>continued</i>											
SPACE STAR (98-04) <i>continued</i>											
1.8 GDI (DG5A)	87/90	4G93-H		06/98-08/02	VKB20	5625	1.1	-	-	VKB20	4
1.8 MPI	82	4G93		10/02-12/04	K16PR-U11	3130	1.1	K16TT	IK16TT	IK16TT	4
1.9 DI-D	85	F9Q2		10/02-12/04	DG-005		11V				4
1.9 DI-D (DG4A)	75	F9Q1		02/01-12/04	DG-005		11V				4
SPACE WAGON (83-92)											
1.8 GLX (D05V, D05W)	66	4G37		01/84-12/88	W20EPR-U11	3049	1.1	W20TT	IW20TT	IW20TT	4
1.8 TD (D09V, D09W)	55	4D65 T		06/86-04/91	DG-198		11V				4
2.0 4WD (D08W)	75	4G63		03/85-04/91	W20EPR-U	3047	0.8	W20TT	IW20TT	IW20TT	4
2.0 GLX (D04W)	62	G63B		06/86-05/88	W20EPR-U	3047	0.8	W20TT	IW20TT	IW20TT	4
2.0 GLX 4WD (D08W)	62	G63B		06/86-05/88	W20EPR-U	3047	0.8	W20TT	IW20TT	IW20TT	4
2.0 GLXi (D04W)	74	4G63		06/88-04/91	W20EPR-U	3047	0.8	W20TT	IW20TT	IW20TT	4
2.0 GLXi 4WD (D08W)	74	4G63		06/88-04/91	W20EPR-U	3047	0.8	W20TT	IW20TT	IW20TT	4
SPACE WAGON (91-98)											
1.8 (N31W)	90	4G93		10/91-10/98	K20PR-U	3145	0.8	K20TT	IK20TT	IK20TT	4
1.8 4WD (N41W)	90	4G93		10/91-10/98	K20PR-U	3145	0.8	K20TT	IK20TT	IK20TT	4
1.8 TD (N35W)	55	4D65 T		10/91-10/98	DG-198		11V				4
2.0 (N33W)	98	4G63 (DOHC 16V)		10/92-10/98	K20PR-U11	3121	1.1	K20TT	IK20TT	IK20TT	4
2.0 4WD (N43W)	98	4 G 63		10/92-10/98	W20EPR-U	3047	0.8	W20TT	IW20TT	IW20TT	4
2.0 TD (N38W)	60	4D68 T		10/92-10/98	DG-174		11V				4
2.4 i (N34W)	102	4G64		10/92-05/96	K20PR-U11	3121	1.1	K20TT	IK20TT	IK20TT	4
SPACE WAGON (98-04)											
2.0 GDI	98	4G63-MPI		10/98-12/04	K20PR-U11	3121	1.1	K20TT	IK20TT	IK20TT	4
2.4 GDI	110	4G64-412		10/98-04/02	K16PR-U	3191	0.8	K16TT	IK16TT	IK16TT	4
2.4 GDI	108/ 110	4G64 (GDI); 4G64-412;4G64-481	Direct Injection	10/98-12/04	VKB16	5624	1.1	-	-	VKB16	4
2.4 GDI 4WD	108/ 110	4G64-412; 4G64-481	Direct Injection	10/98-12/04	VKB16	5624	1.1	-	-	VKB16	4
STARION (82-90)											
2.0 Turbo Eci (A183A)	125/ 132	4G63-0R;4G63-0W		06/82-08/87	W22ESR-U	3098	0.8	-	-	-	4
2.6 Turbo Eci (A187A)	114	G54B-1J		09/87-06/90	W20EPR-U11	3049	1.1	W20TT	IW20TT	IW20TT	4
TOPPO (90-03)											
0.7	37	3G83 (SOHC 12V)		10/90-07/03	KJ20CR-U11	3451	1.1	K20TT	IK20TT	IK20TT	3
0.7	47	4A30T		09/93-07/03	XU22EPR-U	3179	0.9	XU22TT	-	VXU22	4
0.7 4WD	37	3G83 (SOHC 12V)		10/90-07/03	KJ20CR-U11	3451	1.1	K20TT	IK20TT	IK20TT	3
0.7 4WD	47	4A30T		09/93-07/03	XU22EPR-U	3179	0.9	XU22TT	-	VXU22	4
TOPPO (08-)											
0.7	37	3G83 (SOHC 12V)		08/08-	KJ20CR-U11	3451	1.1	K20TT	IK20TT	IK20TT	3
0.7 4WD	37	3G83 (SOHC 12V)		08/08-	KJ20CR-U11	3451	1.1	K20TT	IK20TT	IK20TT	3
0.7 4WD	47	3G83 T (SOHC 12V)		08/08-	VK20Y	5620	0.8	-	-	VK20Y	3
MITSUBISHI CV											
Canter											
	92/97	4M42-0AT		-	DG-187		11V				4
	69/85	4M40-2AT; 4M40-A		08/96-	DG-306		11V				4
MITSUOKA											
GALUE (96-)											
2.0 DX	96	RB20EE		05/96-08/00	Q16PR-U11	5016	1.1	Q16TT	IQ16TT	IQ16TT	6
2.5	154	VQ25DDLE		09/00-	VK16	5603	1.1	-	IK16TT	IK16TT	6
2.5	136	VQ25DE		12/04-	VKH16	5617	1.1	-	IKH16TT	IKH16TT	6
3.0 Luxury	177	VQ30DDLE		09/00-	VK16	5603	1.1	-	IK16TT	IK16TT	6
HIMIKO (08-)											
2.0	119/ 125	LF-VE		09/08-	ITV20	5339	1.1	-	ITV20TT	ITV20TT	4
LA SEYDE (00-04)											
2.0	118	SR20DE		02/00-08/04	K20R-U	3122	0.8	K20TT	IK20TT	IK20TT	4
NOUERA (02-)											
2.0 Luxury	114	KA20A		04/02-	KJ20DR-M11	3374	1.1	-	IK20TT	IK20TT	4
2.0 Luxury All-wheel Drive	114	KA20A		04/02-	KJ20DR-M11	3374	1.1	-	IK20TT	IK20TT	4
2.4 Royal	147	KA24A		09/02-	SKJ20DR-M11	3377	1.1	-	IK20TT	IK20TT	4
OROCHI (06-)											
3.3 L V6	171	3MZ-FE		09/06-	SK20R11	3297	1.1	-	IK20TT	IK20TT	6
RYOGA (99-)											
1.5 DX	77	QG15DE		06/99-	K16PR-U11	3130	1.1	K16TT	IK16TT	IK16TT	4
1.5 Royal All-wheel Drive	77	QG15DE		06/99-	K16PR-U11	3130	1.1	K16TT	IK16TT	IK16TT	4
1.8 Royal	96	QG18DD		09/02-	PK16R11	3134	1.1	K16TT	IK16TT	IK16TT	4
VIEWT (K11) (94-01)											
1.0	43	K10DE		04/94-08/01	K16PR-U11	3130	1.1	K16TT	IK16TT	IK16TT	4
1.3	55	CG13DE		05/96-08/01	K16PR-U11	3130	1.1	K16TT	IK16TT	IK16TT	4

	KW					Standard 			Twin Tip 				QTY	
MITSUBISHI <i>continued</i>														
VIEWT (K11) (94-01) <i>continued</i>														
1.3 G	55	CG13DE		05/96-08/01	K16PR-U11	3130	1.1		K16TT	IK16TT	IK16TT		4	
VIEWT (K12) (05-)														
1.2 Royal	66	CR12DE		02/05-	VKH16	5617	1.1	-		IKH16TT	IKH16TT		4	
1.4 Royal All-wheel Drive	71	CR14DE		02/05-	VKH16	5617	1.1	-		IKH16TT	IKH16TT		4	
1.5 Royal	80	HR15DE		02/05-	FXE20HE11	3436	1.1	-		IXEH20ETT	IXEH20ETT		4	
YUGA (99-)														
1.3 Royal	63	CGA3DE		06/99-	K16PR-U11	3130	1.1		K16TT	IK16TT	IK16TT		4	
1.3 Royal All-wheel Drive	63	CGA3DE		06/99-	K16PR-U11	3130	1.1		K16TT	IK16TT	IK16TT		4	
ZERO I (95-01)														
1.6	88	B6LJ		06/95-08/01	K16PR-U11	3130	1.1		K16TT	IK16TT	IK16TT		4	
MORGAN														
AERO 8 (00-)														
4.4	210/245	M62448S2; N62B44A		10/00-	K20TXR	5063	1.0		K20TT	IK20TT	IK20TT		8	
4.8	270	N62 B48 B		10/08-	VK20	5604	1.1	-		IK20TT	IK20TT		8	
AERO (12-)														
4.8 V8	270			10/12-	VK20	5604	1.1	-		IK20TT	IK20TT		8	
AERO Supersports (10-)														
4.8 V8	270	N62 B48 B		03/10-	VK20	5604	1.1	-		IK20TT	IK20TT		8	
FOUR FOUR (68-)														
1.6 CVH/OHV	71	LUA		08/82-09/91	Q20PR-U	3007	0.8		Q20TT	IQ20TT	IQ20TT		4	
1.6 i Kat	77	LJA		08/91-	Q20PR-U	3007	0.8		Q20TT	IQ20TT	IQ20TT		4	
1.8 i	92			01/93-01/05	PT16VR10	5093	1.0		TV16TT	ITV16TT	ITV16TT		4	
PLUS EIGHT (68-)														
3.5	115			01/68-12/86	W20EPR-U	3047	0.8		W20TT	IW20TT	IW20TT		8	
4.8 V8	270			03/10-	VK20	5604	1.1	-		IK20TT	IK20TT		8	
PLUS FOUR (85-)														
1.8 i	96	RQB		01/93-	PT16VR10	5093	1.0		TV16TT	ITV16TT	ITV16TT		4	
2.0 i	99/103	M16i		08/88-	Q20PR-U	3007	0.8		Q20TT	IQ20TT	IQ20TT		4	
ROADSTER (04-)														
2.0 Plus4	106	AODA		01/04-	ZT20EPR11	5087	1.1		T20TT	IT20TT	IT20TT		4	
MORRIS														
ITAL (80-84)														
1.3	44			07/80-03/84	Q20PR-U	3007	0.8		Q20TT	IQ20TT	IQ20TT		4	
1.7	58			07/80-03/84	T20EPR-U	5032	0.8		T20TT	IT20TT	IT20TT		4	
MARINA (71-80)														
1,3	42			10/78-10/80	W20EP-U	3043	0.8		W20TT	IW20TT	IW20TT		4	
1300	42			10/75-09/78	W20EP-U	3043	0.8		W20TT	IW20TT	IW20TT		4	
MINI (60-81)														
850	25			01/60-08/79	W20EPR-U	3047	0.8		W20TT	IW20TT	IW20TT		4	
1000	28			01/69-12/80	W20EPR-U	3047	0.8		W20TT	IW20TT	IW20TT		4	
1100 Special	33			01/76-08/81	W20ESR-U	3057	0.8	-		-	-		4	
Cooper	41			01/61-12/67	W20EPR-U	3047	0.8		W20TT	IW20TT	IW20TT		4	
MINOR (55-71)														
0.9	28			11/55-12/61	W20ESR-U	3057	0.8	-		-	-		4	
1.1	37			01/62-10/71	W20ESR-U	3057	0.8	-		-	-		4	
OXFORD (59-70)														
1.7	63			05/62-04/70	W20ESR-U	3057	0.8	-		-	-		4	
MOSKVICH														
407 (58-)														
1.4	33			08/58-	W22EPR-U	3088	0.8		W22TT	-	VW22		4	
412 (71-)														
1.5	55			03/71-	W20EP-U	3043	0.8		W20TT	IW20TT	IW20TT		4	
2140 (78-83)														
1.5	55			07/78-11/83	W22EPR-U	3088	0.8		W22TT	-	VW22		4	
21412 (89-01)														
1.5	51			05/89-12/01	W22EPR-U	3088	0.8		W22TT	-	VW22		4	
1.6	56/59			05/94-12/01	W20EP-U	3043	0.8		W20TT	IW20TT	IW20TT		4	
1.7	63			03/95-12/01	W20EPR-U	3047	0.8		W20TT	IW20TT	IW20TT		4	
ASLK 2137 (76-)														
1.5	55			07/76-	W22EPR-U	3088	0.8		W22TT	-	VW22		4	
ASLK 2140 (76-)														
1.5	55			03/76-	W22EPR-U	3088	0.8		W22TT	-	VW22		4	
MULTICAR CV														
M25														
	34/40	4 VD 8.8/9-1 SRF; 028.B M 344/M 841		01/85-12/92	DG-012		11V						4	

Spark & Glow Plugs

Application Tables

	KW					Standard			Twin Tip				QTY	
MULTICAR CV <i>continued</i>														
M26														
	40	028.B M 344/M 841		06/92-12/92	DG-012			11V						4
NISSAN														
100 NX (90-94)														
1.6	66	GA16DS		03/90-10/92	K16PR-U	3191	0.8		K16TT	IK16TT	IK16TT			4
1.6 SR	75	GA16DE		09/93-10/94	K16PR-U	3191	0.8		K16TT	IK16TT	IK16TT			4
2.0 GTI	105	SR20DE		03/91-10/94	K16R-U	3119	0.8		K16TT	IK16TT	IK16TT			4
180 SX (88-94)														
2.0 Turbo	147	SR20DET		04/91-03/94	PK20PR-P8	3245	0.8	-		IK20TT	IK20TT			4
200 SX (88-94)														
1.8 Turbo	122/ 124	CA18DET; CA18DT		07/88-09/94	PQ20R	3117	1.1		Q20TT	IQ20TT	IQ20TT			4
200 SX (93-99)														
2.0 i 16V	118	SR20DE		10/93-12/99	K20R-U	3122	0.8		K20TT	IK20TT	IK20TT			4
2.0 i 16V Turbo	147	SR20DET		10/93-12/99	PK22PR8	3273	0.8	-	-		VK22			4
300 ZX (84-90)														
3.0	125	VG30E		01/84-12/87	Q16R-U11	3006	1.1		Q16TT	IQ16TT	IQ16TT			6
3.0	125	VG30E		02/87-12/87	Q20PR-U11	3008	1.1		Q20TT	IQ20TT	IQ20TT			6
3.0 Turbo	149/ 168	VG30ET; VG30T		04/84-10/90	Q20PR-U11	3008	1.1		Q20TT	IQ20TT	IQ20TT			6
3.0 Turbo	149/ 168	VG30ET; VG30T	OEM Optional	04/84-10/90	Q22PR-U11	3257	1.1	-	-		VQ22			6
350 Z (02-)														
3.5	230	VQ35HR		04/07-	VFXEH22	5646	1.1	-		IXEH22TT	IXEH22TT			6
3.5	221	VQ35DE		04/06-	VKH16	5617	1.1	-		IKH16TT	IKH16TT			6
3.5	206/ 221	VQ35DE		09/02-	VKH20	5618	1.1	-		IKH20TT	IKH20TT			6
370 Z (09-)														
3.7	241/ 243	VQ37HR; VQ37VHR		01/10-	FXE24HR11	3457	1.1	-	-		FXE24HR11			6
AD Wagon (99-04)														
1.5	66	QG15DE		05/99-08/04	K16PR-U11	3130	1.1		K16TT	IK16TT	IK16TT			4
ALMERA I (95-00)														
1.4	64	GA14DE		09/95-07/00	K16PR-U	3191	0.8		K16TT	IK16TT	IK16TT			4
1.4 GX,LX	55	GA14DE		09/95-07/00	K16PR-U	3191	0.8		K16TT	IK16TT	IK16TT			4
1.4 S,GX,LX	55	GA14DE		09/95-03/00	K16PR-U	3191	0.8		K16TT	IK16TT	IK16TT			4
1.6	73	GA16DE		09/95-07/00	K16PR-U	3191	0.8		K16TT	IK16TT	IK16TT			4
1.6	73	GA16DE		09/95-03/00	K20PR-U	3145	0.8		K20TT	IK20TT	IK20TT			4
1.6 SLX	66	GA16DE		09/95-07/00	K16PR-U	3191	0.8		K16TT	IK16TT	IK16TT			4
1.6 SR,SLX	66	GA16DE		09/95-03/00	K16PR-U	3191	0.8		K16TT	IK16TT	IK16TT			4
2.0 D	55	CD20		11/95-07/00	DG-304			11V						4
2.0 GTi	105	SR20DE		07/96-03/00	K20R-U11	3139	1.1		K20TT	IK20TT	IK20TT			4
ALMERA II (00-)														
1.5	72/77	GA15DE; QG15DE		03/01-	K16HPR-U11	6076	1.1		KH16TT	IKH16TT	IKH16TT			4
1.5	66	QG15DE		03/00-09/02	K16PR-U11	3130	1.1		K16TT	IK16TT	IK16TT			4
1.5 dCi	60	K9K 722		01/03-	DG-005			11V						4
1.5 XL	77	QG15DE		03/01-	K16HPR-U11	6076	1.1		KH16TT	IKH16TT	IKH16TT			4
1.6 16V	79	QG16DE		05/10-	K16HPR-U11	6076	1.1		KH16TT	IKH16TT	IKH16TT			4
1.6 16V	79	QG16DE		03/06-04/10	K20PR-U11	3121	1.1		K20TT	IK20TT	IK20TT			4
1.8	85	QG18DE		10/02-	K16HPR-U11	6076	1.1		KH16TT	IKH16TT	IKH16TT			4
1.8	84	QG18DE		01/00-09/02	K16PR-U11	3130	1.1		K16TT	IK16TT	IK16TT			4
1.8	94	QG18DE		01/02-	K20HR-U11	3381	1.1		KH20TT	IKH20TT	IKH20TT			4
2.0	107	SR20DE		08/02-	PK20PR-L11	3142	1.1	-		IK20TT	IK20TT			4
2.2 dCi	82/ 100	YD22DDTi		09/03-	DG-197			11V						4
2.2 Di	81	YD22DDT		03/00-	DG-197			11V						4
ALMERA TINO (00-)														
1.8	85	QG18DE		12/02-	K16HPR-U11	6076	1.1		KH16TT	IKH16TT	IKH16TT			4
1.8	84	QG18DE		08/00-09/02	K16PR-U11	3130	1.1		K16TT	IK16TT	IK16TT			4
2.0	100	SR20DE		08/00-	PK20PR-L11	3142	1.1	-		IK20TT	IK20TT			4
2.2 dCi	82/ 100	YD22DDTi		09/03-	DG-197			11V						4
2.2 Di	84	YD22DDTi		08/00-	DG-197			11V						4
ALTIMA (01-06)														
3.5	180	VQ35DE		08/01-09/06	VKH16	5617	1.1	-		IKH16TT	IKH16TT			6
ALTIMA (06-)														
2.5	128	QR25DE		10/06-	FXE20HR11	3439	1.1	-		IXEH20TT	IXEH20TT			4
AVENIR (92-97)														
2.0 TD	66	CD20T		11/92-10/97	DG-304			11V						4
BLUEBIRD (80-86)														
1.6	60	L16		01/80-11/83	W20EP-U	3043	0.8		W20TT	IW20TT	IW20TT			4







Spark & Glow Plugs





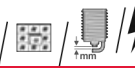

Application Tables







KW	KW	KW	KW	KW	Standard			Twin Tip			QTY
					Standard	Standard	Standard	Twin Tip	Twin Tip	Twin Tip	
NISSAN <i>continued</i>											
BLUEBIRD (80-86) <i>continued</i>											
1.8	65/66	L18S; L18T		01/80-05/84	W20EPR-U	3047	0.8	W20TT	IW20TT	IW20TT	4
2.0 D	44	LD20		01/80-05/84	DG-012		11V				4
2.0 i	80	Z20E		01/82-12/83	W20EPR-U11	3049	1.1	W20TT	IW20TT	IW20TT	4
BLUEBIRD (83-90)											
1.8	66	CA18S		11/83-04/90	Q20PR-U	3007	0.8	Q20TT	IQ20TT	IQ20TT	4
1.8	66	CA18S		11/83-06/88	W20EPR-U	3047	0.8	W20TT	IW20TT	IW20TT	4
1.8 Turbo	99	CA18ET; CA18T		04/84-05/90	Q20PR-U11	3008	1.1	Q20TT	IQ20TT	IQ20TT	4
2.0	85	CA20E		12/85-01/88	Q20PR-U11	3008	1.1	Q20TT	IQ20TT	IQ20TT	4
2.0	75	CA20S		12/85-09/90	W20EPR-U11	3049	1.1	W20TT	IW20TT	IW20TT	4
2.0 i	77/85	CA20E		04/84-09/90	Q20PR-U11	3008	1.1	Q20TT	IQ20TT	IQ20TT	4
2.0 LX	66	CA20S		12/85-02/90	W20EPR-U11	3049	1.1	W20TT	IW20TT	IW20TT	4
BLUEBIRD (85-92)											
1.6	61/66	CA16S		03/86-06/91	Q20PR-U	3007	0.8	Q20TT	IQ20TT	IQ20TT	4
1.8 i 16V (FRLT72)	95	CA18D		02/89-12/90	PQ20R	3117	1.1	Q20TT	IQ20TT	IQ20TT	4
1.8 i 16V (RLT72)	95	CA18D		02/89-12/90	PQ20R	3117	1.1	Q20TT	IQ20TT	IQ20TT	4
1.8 Turbo	99	CA18T		12/85-11/92	Q20PR-U11	3008	1.1	Q20TT	IQ20TT	IQ20TT	4
2.0 (T12)	75	CA20S		12/85-12/87	W16EPR-U11	3201	1.1	W16TT	IW16TT	IW16TT	4
2.0 (T12)	75	CA20S		12/85-12/87	W20EPR-U11	3049	1.1	W20TT	IW20TT	IW20TT	4
2.0 D (FSLT72, T12)	49	LD20		03/86-12/90	DG-307		11V				4
2.0 D (SLT72, T12)	49	LD20		03/86-12/90	DG-307		11V				4
2.0 i	85	CA20E		09/88-09/90	Q20PR-U11	3008	1.1	Q20TT	IQ20TT	IQ20TT	8
2.0 i (FHLT72, T12)	77	CA20E		12/85-12/90	Q20PR-U11	3008	1.1	Q20TT	IQ20TT	IQ20TT	8
2.0 i (HLT72, T12)	77	CA20E		12/85-12/90	Q16PR-U11	5016	1.1	Q16TT	IQ16TT	IQ16TT	8
BLUEBIRD SYLPHY (00-05)											
1.5	77	QG15DE		08/00-08/05	K16PR-U11	3130	1.1	K16TT	IK16TT	IK16TT	4
CABSTAR (92-11)											
2.0	66	Z20S		07/92-05/94	W16EPR-U	3021	0.8	W16TT	IW16TT	IW16TT	4
CEDRIC (83-87)											
2.0	75	CA20S		05/84-08/87	W20EPR-U	3047	0.8	W20TT	IW20TT	IW20TT	4
3.0	132	VG30E		10/83-08/87	Q20P-U11	3136	1.1	Q20TT	IQ20TT	IQ20TT	6
3.0	132	VG30E	OEM Optional	07/85-08/87	Q20PR-U11	3008	1.1	Q20TT	IQ20TT	IQ20TT	6
CHERRY I (E10) (70-78)											
1.0	33	A10		11/75-09/78	W14EPR-U	6011	0.8	-	IW16TT	IW16TT	4
CHERRY II (N10) (78-83)											
1.0	32/33	A10S		08/78-07/81	W14EPR-U	6011	0.8	-	IW16TT	IW16TT	4
1.2	38	A12		10/78-07/81	W14EPR-U	6011	0.8	-	IW16TT	IW16TT	4
1.2	38	A12		08/78-07/81	W20EPR-U	3047	0.8	W20TT	IW20TT	IW20TT	4
1.3	44	E13		08/81-09/82	W20EPR-U	3047	0.8	W20TT	IW20TT	IW20TT	4
1.4	59	A14S		08/80-07/81	W16EPR-U	3021	0.8	W16TT	IW16TT	IW16TT	4
1.4 i.e.	59	A14S		08/80-07/81	W16EPR-U	3021	0.8	W16TT	IW16TT	IW16TT	4
1.5	51	E15		08/81-12/82	W16EPR-U11	3201	1.1	W16TT	IW16TT	IW16TT	4
CHERRY III (N12) (82-86)											
1.0	37	E10		05/82-05/86	W16EPR-U	3021	0.8	W16TT	IW16TT	IW16TT	4
1.3	44	E13		05/82-10/86	W20EPR-U	3047	0.8	W20TT	IW20TT	IW20TT	4
1.5	55	E15S		11/83-10/86	W16EPR-U	3021	0.8	W16TT	IW16TT	IW16TT	4
1.5 ET Turbo	77	E15ET		01/83-12/85	W20EPR-U	3047	0.8	W20TT	IW20TT	IW20TT	4
1.6	51	E16		06/85-07/86	W16EXR-U11	3032	1.1	W16TT	IW16TT	IW16TT	4
CLIPPER Van (03-)											
0.7	35	3G83		04/03-	KJ20CR-U11	3451	1.1	K20TT	IK20TT	IK20TT	3
CUBE (03-05)											
1.4	72	CR14DE		01/03-09/05	IKH16	5343	1.1	-	IKH16TT	IKH16TT	4
1.4 4x4	72	CR14DE		01/03-09/05	IKH16	5343	1.1	-	IKH16TT	IKH16TT	4
1.5	80	HR15DE		01/03-09/05	K16HPR-U11	6076	1.1	KH16TT	IKH16TT	IKH16TT	4
1.5 4x4	80	QG15DE		01/03-09/05	K16HPR-U11	6076	1.1	KH16TT	IKH16TT	IKH16TT	4
CUBE (10-)											
1.5 dCi	78/81			03/10-	DG-609		4.4V				4
1.6 16V	81	HR16DE		03/10-	FXE20HR11	3439	1.1	-	IXEH20TT	IXEH20TT	4
DATSUN 100 A (74-80)											
F-II 1.0 (BLF10)	33	A10		12/75-01/79	W14EPR-U	6011	0.8	-	IW16TT	IW16TT	4
F-II 1.0 (WBLF10)	33	A10		12/75-01/79	W14EPR-U	6011	0.8	-	IW16TT	IW16TT	4
DATSUN 120 (74-80)											
A F-II 1.2 (LF10)	38	A12		11/77-07/80	W14EPR-U	6011	0.8	-	IW16TT	IW16TT	4
Y 1.2 (B210)	38	A12		11/77-07/80	W14EPR-U	6011	0.8	-	IW16TT	IW16TT	4
Y 1.2 (LB210)	38			11/77-07/80	W14EPR-U	6011	0.8	-	IW16TT	IW16TT	4
DATSUN 120 Y (62-80)											
1.2 (KB210)	38	A12		11/77-07/80	W14EPR-U	6011	0.8	-	IW16TT	IW16TT	4
A F-II 1.2 (KLF10)	38	A12		11/77-08/80	W14EPR-U	6011	0.8	-	IW16TT	IW16TT	4







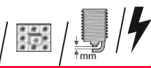

Spark & Glow Plugs







Application Tables

	KW								QTY		
NISSAN <i>continued</i>											
DATSUN 180 B (77-81)											
1.8	65	L18S		04/80-01/81	W20EPR-U	3047	0.8	W20TT	IW20TT	4	
1.8 (KPL810)	66			04/80-01/81	W20EPR-U	3047	0.8	W20TT	IW20TT	4	
ELGRAND (10-)											
2.5	125	QR25DE		11/10-	FXE20HR11	3439	1.1	-	IXEH20TT	IXEH20TT	4
2.5 AWD	125	QR25DE		11/10-	FXE20HR11	3439	1.1	-	IXEH20TT	IXEH20TT	4
3.5	206	VQ35DE		11/10-	VFXEH22	5646	1.1	-	IXEH22TT	IXEH22TT	6
3.5 AWD	206	VQ35DE		11/10-	VFXEH22	5646	1.1	-	IXEH22TT	IXEH22TT	6
FIGARO (91-92)											
1.0	56	MA10ET		02/91-04/92	W20EXR-U11	3067	1.1	W20TT	IW20TT	4	
INTERSTAR (02-)											
dCi 80	60	F9Q 772		07/02-	DG-005		11V			4	
dCi 90	66	G9T 722		07/02-	DG-126		11V			4	
dCi 100	73/74	G9U 650; G9U 720	OE: 11065-00Q0A	11/03-12/11	DG-126		11V			4	
dCi 120	84/88	G9U 650; G9U 720	OE: 11065-00Q0A	07/02-12/11	DG-126		11V			4	
dCi 140	100	ZD30		11/03-09/06	DG-005		11V			4	
dCi 150	107	G9U 632	OE: 11065-00Q0A	10/06-	DG-126		11V			4	
JUKE (10-)											
1.5 dCi	81	K9K 410; K9K 636; K9K 896		06/10-12/12	DG-609		4.4V			4	
1.6	86	HR16DE		06/10-	FXE20HE11	3436	1.1	-	IXEH20ETT	IXEH20ETT	4
1.6	69	HR16DE	Japan	01/13-	VFKH16	5654	1.1	-	IKH16TT	IKH16TT	4
KUBISTAR (03-)											
1.2	44	D7F 764		08/03-	XE20HR-U9	3427	0.9	-	IXEH20TT	IXEH20TT	4
1.2 16V	55	D4F 712		04/06-	XE20HR-U9	3427	0.9	-	IXEH20TT	IXEH20TT	4
1.5 dCi	42/45/48/60	K9K 704; K9K 710; K9K 714; K9K 722		08/03-	DG-005		11V			4	
1.5 dCi 70	50	K9K 700; K9K 716		04/06-	DG-005		11V			4	
1.5 dCi 85	62	K9K 276		04/06-	DG-005		11V			4	
LATIO (04-)											
1.5	80	HR15DE		11/04-	FXE20HE11	3436	1.1	-	IXEH20ETT	IXEH20ETT	4
1.5	80	HR15DE	OEM Optional	11/04-	FXE16HE11	3438	1.1	-	-	FXE16HE11	4
1.5 4x4	80	HR15DE		11/04-	FXE20HE11	3436	1.1	-	IXEH20ETT	IXEH20ETT	4
1.5 4x4	80	HR15DE	OEM Optional	11/04-	FXE16HE11	3438	1.1	-	-	FXE16HE11	4
1.6	81	HR16DE		03/07-	FXE20HR11	3439	1.1	-	IXEH20TT	IXEH20TT	4
LAUREL (77-83)											
2.0	71	L20A		03/77-05/81	W16EPR-U	3021	0.8	W16TT	IW16TT	6	
2.4	83	L24		12/77-05/83	W20EPR-U	3047	0.8	W20TT	IW20TT	6	
LAUREL (81-85)											
2.0	71	L20A		01/81-01/84	W16EPR-U	3021	0.8	W16TT	IW16TT	6	
2.4	83/88	L24		01/81-12/85	W20EPR-U	3047	0.8	W20TT	IW20TT	6	
2.8 D	62	LD28		01/81-10/85	DG-012		11V			6	
LAUREL (84-89)											
2.4	94	L24E; L24S		01/85-12/87	W16EPR-U	3021	0.8	W16TT	IW16TT	6	
2.8 D	62	LD28		01/85-12/87	DG-012		11V			6	
2.8 D	66	RD28		01/85-12/89	DG-307		11V			6	
MAXIMA (88-94)											
3.0 i	125	VG30E		10/88-06/94	PK16PR-L11	3275	1.1	-	IK16TT	IK16TT	6
MAXIMA QX (95-00)											
2.0	103	VQ20DE		02/95-08/00	PK20PR11	3168	1.1	K20TT	IK20TT	6	
3.0	142	VQ30DE		01/95-08/00	PK20PR11	3168	1.1	K20TT	IK20TT	6	
MAXIMA QX (00-03)											
2.0 V6 24V	103	VQ20DE		03/00-11/03	PK16PR-L11	3275	1.1	-	IK16TT	IK16TT	6
3.0 V6 24V	147	VQ30DE		03/00-11/03	PK20PR11	3168	1.1	K20TT	IK20TT	6	
MICRA C+C (05-)											
1.4 16V	65	CR14DE		08/05-	IKH16	5343	1.1	-	IKH16TT	IKH16TT	4
1.6 160 SR	81	HR16DE		08/05-	FXE20HR11	3439	1.1	-	IXEH20TT	IXEH20TT	4
MICRA I (82-92)											
1.0	37/40/43	MA10S		12/82-05/91	W16EPR-U	3021	0.8	W16TT	IW16TT	4	
1.2	40/44	MA12S		07/86-07/92	W16EPR-U	3021	0.8	W16TT	IW16TT	4	
MICRA II (92-03)											
1.0 i 16V	40/44	CG10DE		08/92-02/03	K16PR-U11	3130	1.1	K16TT	IK16TT	4	
1.3 i 16V	55	CG13DE		08/92-09/00	K16PR-U11	3130	1.1	K16TT	IK16TT	4	
1.4 i 16V	60	CGA3DE		09/00-02/03	K16PR-U11	3130	1.1	K16TT	IK16TT	4	

	KW					Standard			Twin Tip			QTY	
NISSAN <i>continued</i>													
MICRA II (92-03) <i>continued</i>													
1.5 D	42	TD15		02/98-02/03	DG-003		11V						4
MICRA III (03-10)													
1.0 16V	48	CG10DE		01/03-05/05	IKH16	5343	1.1	-	IKH16TT	IKH16TT			4
1.2 16V	48/59	CG12DE; CR12DE		01/03-06/10	K16HR-U11	3482	1.1	-	KH16TT	IKH16TT	IKH16TT		4
1.2 16V	59	CG12DE; CR12DE	LEAN BURN	01/03-06/10	IKH16	5343	1.1	-	IKH16TT	IKH16TT	IKH16TT		4
1.2 16V	48	CG12DE; CR12DE	OEM Optional	01/03-06/10	IKH16	5343	1.1	-	IKH16TT	IKH16TT	IKH16TT		4
1.4 16V	65	CR14DE		01/03-04/09	IKH16	5343	1.1	-	IKH16TT	IKH16TT	IKH16TT		4
1.5 dCi	48/ 50/ 60/ 63	K9K 276; K9K 704; K9K 708; K9K 722		01/03-06/10	DG-005		11V						4
160 SR	81	HR16DE		05/05-06/10	FXE20HR11	3439	1.1	-	IXEH20TT	IXEH20TT	IXEH20TT		4
MICRA IV (10-)													
1.2	56/59	HR12DE		05/10-	IKH16	5343	1.1	-	IKH16TT	IKH16TT	IKH16TT		3
1.2 DIG	72	HR12DDR		04/11-	VFXEH20	5645	1.1	-	IXEH20TT	IXEH20TT	IXEH20TT		3
1.5	75	HR15DE		11/10-	FXE20HE11	3436	1.1	-	IXEH20ETT	IXEH20ETT	IXEH20ETT		4
MURANO (03-)													
3.5 4x4	172	VQ35DE		08/03-06/08	VKH20	5618	1.1	-	IKH20TT	IKH20TT	IKH20TT		6
MURANO (07-)													
3.5	195	VQ35DE		10/08-	VFXEH22	5646	1.1	-	IXEH22TT	IXEH22TT	IXEH22TT		6
3.5	195	VQ35DE		11/07-09/08	VKH16	5617	1.1	-	IKH16TT	IKH16TT	IKH16TT		6
3.5 4x4	188/ 195	VQ35DE		10/08-	VFXEH22	5646	1.1	-	IXEH22TT	IXEH22TT	IXEH22TT		6
3.5 4x4	195	VQ35DE		11/07-09/08	VKH16	5617	1.1	-	IKH16TT	IKH16TT	IKH16TT		6
NAVARA (D40) (05-)													
2.5 dCi	106/ 128	YD25DDTi		07/05-	DG-197		11V						4
2.5 dCi 4WD	126/ 128	YD25DDTi		07/05-	DG-197		11V						4
NOTE (06-)													
1.4	65	CR14DE		03/06-	IKH16	5343	1.1	-	IKH16TT	IKH16TT	IKH16TT		4
1.5 dCi	50/ 63/ 76	K9K 276; K9K 292; K9K 700		10/10-	DG-005		11V						4
1.5 dCi	50/ 63/ 66/ 76	K9K 276; K9K 292; K9K 700		11/10-	DG-609		4.4V						4
1.6	81	HR16DE		03/06-	FXE20HR11	3439	1.1	-	IXEH20TT	IXEH20TT	IXEH20TT		4
NOTE (13-)													
1.2	59	HR12DE		06/13-	IKH16	5343	1.1	-	IKH16TT	IKH16TT	IKH16TT		3
1.5 dCi	66	K9K 608		06/13-	DG-609		4.4V						4
NP300 (08-)													
2.5 dCi	98	YD25DDTi		04/08-	DG-197		11V						4
2.5 dCi 4x4	98	YD25DDTi		04/08-	DG-197		11V						4
NV200 (10-)													
1.5 dci	63			10/10-	DG-005		11V						4
1.5 dci	63/ 66/ 81			11/10-	DG-609		4.4V						4
1.6 16V	81	HR16DE		02/10-	FXE20HR11	3439	1.1	-	IXEH20TT	IXEH20TT	IXEH20TT		4
PATHFINDER (86-95)													
2.4 4WD	74	Z24i		07/86-04/92	W20EPR-U	3047	0.8	-	W20TT	IW20TT	IW20TT		4
PATHFINDER (97-04)													
2.7 TD 4WD	96	TD27ETi		09/97-12/04	DG-198		11V						4
3.3 V6 4WD	110/ 125	VG33E		09/97-08/03	Q20PR-U11	3008	1.1	-	Q20TT	IQ20TT	IQ20TT		6
3.5 V6 4WD	162	VQ35		11/00-08/03	VKH16	5617	1.1	-	IKH16TT	IKH16TT	IKH16TT		6
PATHFINDER (05-)													
2.5 DCi	128	YD25DDTi		01/05-	DG-197		11V						4
2.5 dCi 4WD	126/ 128	YD25DDTi		03/05-	DG-197		11V						4
4.0 4WD	198	VQ40DE		09/05-	VKH20	5618	1.1	-	IKH20TT	IKH20TT	IKH20TT		6
PATROL (79-88)													
2.8 (K160)	88/89	L28		07/80-08/88	W20EPR-U	3047	0.8	-	W20TT	IW20TT	IW20TT		6
2.8 (W160)	88	L28		07/80-08/88	W20EPR-U	3047	0.8	-	W20TT	IW20TT	IW20TT		6
3.2 D (K160)	70	SD33		07/85-08/88	DG-157		11V						6
3.2 D (K160)	70	SD33		11/79-08/88	DG-702		24V						6
3.2 D (W160)	70	SD33		07/85-08/88	DG-157		11V						6
3.2 D (W160)	70	SD33		11/79-08/88	DG-702		24V						6
3.2 TD (K160)	81	SD33T		07/85-08/88	DG-157		11V						6
3.2 TD (K160)	81	SD33T		07/83-08/88	DG-702		24V						6











	KW								QTY		
NISSAN <i>continued</i>											
PATROL (79-88) <i>continued</i>											
3.2 TD (W160)	81	SD33T		07/85-08/88	DG-157		11V		6		
3.2 TD (W160)	81	SD33T		07/83-08/88	DG-702		24V		6		
3.3 D 4x4 (G160)	70	SD33		07/85-12/87	DG-157		11V		6		
3.3 D 4x4 (G160)	70	SD33		06/80-12/87	DG-702		24V		6		
3.3 TD 4x4 (G160)	81	SD33T		07/85-12/87	DG-157		11V		6		
3.3 TD 4x4 (G160)	81	SD33T		01/84-12/87	DG-702		24V		6		
PATROL (84-96)											
2.8	88	L28		05/86-02/89	W16EPR-U	3021	0.8	W16TT	IW16TT	IW16TT	6
2.8 TD	85	RD28T		03/89-11/95	DG-306		11V				6
3.2 D	81	SD33T		08/88-06/90	DG-157		11V				6
3.2 D	81	SD33T		08/88-06/90	DG-702		24V				6
PATROL GR I (87-98)											
4.2 CAT	121	TB42E		11/88-02/98	W16EPR-U	3021	0.8	W16TT	IW16TT	IW16TT	6
4.2 D (Y60GR)	85	TD42		11/88-06/97	DG-198		11V				6
PATROL GR II (97-)											
2.8 TD	95	RD28Ti		06/97-05/00	DG-306		11V				6
2.8 TDIC	96	RD28Ti		10/97-02/00	DG-306		11V				6
3.0 DTi	116/ 118	ZD30DDTi		05/00-	DG-605		11V				4
3.2 D	70	SD33		05/98-06/01	DG-702		24V				6
4.8	180	TB48DE		10/02-07/04	VKH20	5618	1.1	-	IKH20TT	IKH20TT	6
PATROL III (10-)											
5.6	298	VK56VD		04/10-	VFXEH22	5646	1.1	-	IXEH22TT	IXEH22TT	8
PICK UP (D22) (97-)											
2.4 i	88	KA24E		02/98-11/01	K16GPR-U11	3135	1.1	-	-	-	4
2.4 i	88	KA24E		11/01-	K16PR-U11	3130	1.1	K16TT	IK16TT	IK16TT	4
2.4 i 4WD	88	KA24E		02/98-11/01	K16GPR-U11	3135	1.1	-	-	-	4
2.4 i 4WD	98	KA24DE		03/02-	K16PR-U11	3130	1.1	K16TT	IK16TT	IK16TT	4
2.5 Di	98	YD25DDTi		03/02-	DG-197		11V				4
2.5 Di 4WD	98	YD25DDTi		03/02-	DG-197		11V				4
3.2 D 4WD	76	QD32		12/98-	DG-198		11V				4
3.2 D 4WD	76	QD32		12/98-	DG-307		11V				4
3.2 TD	76	QD32		01/97-10/01	DG-198		11V				4
3.2 TD	76	QD32		01/97-10/01	DG-307		11V				4
PICK UP (80-86)											
1.6	51	J16		12/80-05/84	W16EPR-U	3021	0.8	W16TT	IW16TT	IW16TT	4
1.8	59	L18		01/83-03/86	W16EPR-U	3021	0.8	W16TT	IW16TT	IW16TT	4
2.2 4WD	71	Z22		04/83-03/86	W20EP-U	3043	0.8	W20TT	IW20TT	IW20TT	4
2.3 D	51	SD23	OE: 11065T8202	04/83-03/86	DG-157		11V				4
2.5 D 4WD	53	SD25		10/85-03/86	DG-157		11V				4
PICK UP (85-98)											
2.0	64/66	Z20		09/85-08/91	W16EP-U	3018	0.8	W16TT	IW16TT	IW16TT	4
2.3 D	51	SD23		09/85-10/87	DG-157		11V				4
2.4 i 12V	91	KA24E		04/92-02/98	K16GPR-U11	3135	1.1	-	-	-	4
2.4 i 12V 4WD	93	KA24E		04/92-02/98	K16GPR-U11	3135	1.1	-	-	-	4
2.4 i 4WD	74	Z24i		03/86-04/92	W16EPR-U	3021	0.8	W16TT	IW16TT	IW16TT	4
2.5 D	55/ 59/ 61	TD25		09/87-02/98	DG-198		11V				4
2.5 D 4WD	53/55	SD25		09/85-08/91	DG-157		11V				4
2.5 D 4WD	59/61	TD25		08/87-02/98	DG-198		11V				4
2.7 D 4WD	73	TD27		08/87-02/98	DG-198		11V				4
PIXO (09-)											
1.0	50	K10 B		06/09-	ZXU20PR11	3452	1.1	-	-	VXU22	3
PRAIRIE (83-88)											
1.5 S (M10)	55	E15S		01/84-12/87	W20EPR-U	3047	0.8	W20TT	IW20TT	IW20TT	4
1.8 SGL (M10)	65/66	CA18S		07/83-10/87	W20EPR-U	3047	0.8	W20TT	IW20TT	IW20TT	4
2.0 4x4 (NM10)	68	CA20S		06/86-09/88	Q20PR-U	3007	0.8	Q20TT	IQ20TT	IQ20TT	4
PRAIRIE Pro (88-94)											
2.0 i	72	CA20E		10/88-04/92	Q20PR-U11	3008	1.1	Q20TT	IQ20TT	IQ20TT	8
2.0 i 4x4	72	CA20E		10/88-12/92	Q20PR-U11	3008	1.1	Q20TT	IQ20TT	IQ20TT	8
2.4 i	98	KA24E		04/92-07/94	K16GPR-U11	3135	1.1	-	-	-	4
2.4 i 4x4	98	KA24E		04/92-07/94	K16GPR-U11	3135	1.1	-	-	-	4
PRIMASTAR (01-)											
2.0	88	F4R.7.20		03/01-	K20R-U	3122	0.8	K20TT	IK20TT	IK20TT	4
2.0	88	F4R 720		02/03-09/06	PK20PR-P8	3245	0.8	-	IK20TT	IK20TT	4
dCi 80	60	F9Q 762		03/01-	DG-005		11V				4
dCi 100	74	F9Q 760		03/01-	DG-005		11V				4







	KW									QTY	
NISSAN <i>continued</i>											
PRIMASTAR (01-) <i>continued</i>											
dCi 140	99	G9U 730		07/03-	DG-126		11V			4	
dCi 150	107	G9U 632	OE: 11065-00Q0A	10/06-	DG-126		11V			4	
PRIMERA (90-98)											
1.6	66/71/75	GA16DE; GA16DS		06/90-01/96	K20PR-U	3145	0.8	K20TT	IK20TT	IK20TT	4
1.6 i	66/75	GA16DE; GA16DS		07/90-03/98	K20PR-U	3145	0.8	K20TT	IK20TT	IK20TT	4
2.0	110	SR20DE		06/90-01/96	K20PR-U	3145	0.8	K20TT	IK20TT	IK20TT	4
2.0 16V	85	SR20DI		06/90-01/96	K16R-U	3119	0.8	K16TT	IK16TT	IK16TT	4
2.0 16V 4x4	85	SR20DI		04/91-06/96	K16R-U	3119	0.8	K16TT	IK16TT	IK16TT	4
2.0 4x4	110	SR20DE		03/91-04/93	K20R-U	3122	0.8	K20TT	IK20TT	IK20TT	4
2.0 D	55	CD20		07/90-01/96	DG-304		11V				4
2.0 GT	110	SR20DE		06/90-01/96	K20PR-U	3145	0.8	K20TT	IK20TT	IK20TT	4
2.0 i	85	SR20DI		07/90-03/98	K16R-U	3119	0.8	K16TT	IK16TT	IK16TT	4
2.0 i	92	SR20DE		01/95-06/96	K20R-U	3122	0.8	K20TT	IK20TT	IK20TT	4
2.0 i	92	SR20DE		01/95-06/96	Q16PR-U11	5016	1.1	Q16TT	IQ16TT	IQ16TT	4
PRIMERA (96-02)											
1.6 16V	78	QG16DE		06/96-07/02	K16HPR-U11	6076	1.1	KH16TT	IKH16TT	IKH16TT	4
1.6 16V	66/73	GA16DE		09/96-12/01	K16PR-U	3191	0.8	K16TT	IK16TT	IK16TT	4
1.6 16V	73	GA16DE		09/96-07/02	K20PR-U	3145	0.8	K20TT	IK20TT	IK20TT	4
1.8 16V	84	QG18DE		08/99-07/02	K16PR-U11	3130	1.1	K16TT	IK16TT	IK16TT	4
2.0 16V	85	SR20De		06/96-12/01	K16R-U11	3120	1.1	K16TT	IK16TT	IK16TT	4
2.0 16V	96/103/110	SR20DE		09/96-07/02	K20R-U	3122	0.8	K20TT	IK20TT	IK20TT	4
2.0 16V	85	SR20De		09/96-07/02	K20R-U11	3139	1.1	K20TT	IK20TT	IK20TT	4
2.0 TD	66	CD20T		09/96-12/01	DG-304		11V				4
PRIMERA (02-)											
1.6	78/80	QG16DE		03/02-	K16HPR-U11	6076	1.1	KH16TT	IKH16TT	IKH16TT	4
1.6 Visia	80	QG16DE		01/02-01/06	K16HPR-U11	6076	1.1	KH16TT	IKH16TT	IKH16TT	4
1.8	85	QG18DE		03/02-01/06	K16HPR-U11	6076	1.1	KH16TT	IKH16TT	IKH16TT	4
1.9 dCi	85/88			08/02-	DG-005		11V				4
2.0	103	QR20DE		07/02-08/04	K16HPR-U11	6076	1.1	KH16TT	IKH16TT	IKH16TT	4
2.0	103	QR20DE		03/02-08/04	K20HR-U11	3381	1.1	KH20TT	IKH20TT	IKH20TT	4
2.0	103	QR20DE	OEM Optional	03/02-01/06	K16HPR-U11	6076	1.1	KH16TT	IKH16TT	IKH16TT	4
2.0	103	QR20DE	OEM Optional	07/02-08/04	K20HR-U11	3381	1.1	KH20TT	IKH20TT	IKH20TT	4
2.2 dCi	102	YD22DDT		04/03-	DG-197		11V				4
2.2 Di	93	YD22DDT		03/02-	DG-197		11V				4
2.5	125	QG25DD; QR25DE		01/02-01/06	FXE20HR11	3439	1.1	-	IXEH20TT	IXEH20TT	4
QASHQAI (+2) (07-)											
1.5 dCi	76/78	K9K 410; K9K 732; K9K 764		02/07-01/10	DG-005		11V				4
1.5 dCi	76/78/81	K9K 410; K9K 430; K9K 732; K9K 764		01/10-	DG-609		4.4V				4
1.6	84/86	HR16DE		02/07-	FXE20HR11	3439	1.1	-	IXEH20TT	IXEH20TT	4
2.0	103/104	MR20DE		02/07-	FXE20HR11	3439	1.1	-	IXEH20TT	IXEH20TT	4
2.0 All-wheel Drive	103/104	MR20DE		02/07-	FXE20HR11	3439	1.1	-	IXEH20TT	IXEH20TT	4
2.0 dCi	110	M1D; M9R		02/07-01/10	DG-005		11V				4
2.0 dCi All-wheel Drive	110	M1D; M9R		02/07-01/10	DG-005		11V				4
QASHQAI (13-)											
1.5 dCi	81	K9K 636		11/13-	DG-609		4.4V				4
QUEST (03-)											
3.5	176	VQ35DE		05/03-	VKH16	5617	1.1	-	IKH16TT	IKH16TT	6
SERENA (92-01)											
1.6 16V	71	GA16DE		02/93-09/01	K16PR-U	3191	0.8	K16TT	IK16TT	IK16TT	4
2.0 16V	93	SR20DE		11/92-09/01	K20R-U	3122	0.8	K20TT	IK20TT	IK20TT	4
2.0 D	49	LD20		11/92-09/94	DG-307		11V				4
2.3 D	55	LD23		01/95-09/01	DG-137		11V				4
SERENA (05-)											
2.0	108	MR20DE		04/05-	VFXEH20	5645	1.1	-	IXEH20TT	IXEH20TT	4
2.0 4x4	108	MR20DE		04/05-	VFXEH20	5645	1.1	-	IXEH20TT	IXEH20TT	4
2.5	118	QR25DE		02/06-	FXE20HR11	3439	1.1	-	IXEH20TT	IXEH20TT	4
2.5 4x4	118	QR25DE		02/06-	FXE20HR11	3439	1.1	-	IXEH20TT	IXEH20TT	4
SILVIA (84-88)											
1.8	90	CA18ET		07/86-04/88	Q20PR-U11	3008	1.1	Q20TT	IQ20TT	IQ20TT	4
2.0 GP	107	FJ20E		04/84-09/88	W20EPR-U11	3049	1.1	W20TT	IW20TT	IW20TT	4

	KW					Standard		Twin Tip		QTY	
NISSAN <i>continued</i>											
SKYLINE (R32) (89-93)											
2.6 Twin Turbo 4x4	206	RB26DETT		04/89-06/93	PQ20R	3117	1.1	Q20TT	IQ20TT	IQ20TT	6
SKYLINE (R33) (93-00)											
2.5	184	RB25DET		01/94-07/00	IK16	5303	1.1	-	IK16TT	IK16TT	6
2.5	140	RB25DE		07/93-05/98	PK16PR-L11	3275	1.1	-	IK16TT	IK16TT	6
2.5 4x4	140	RB25DE		07/93-05/98	PK16PR-L11	3275	1.1	-	IK16TT	IK16TT	6
2.6 Twin Turbo 4x4	206	RB26DETT		07/94-09/99	PQ20R	3117	1.1	Q20TT	IQ20TT	IQ20TT	6
SKYLINE (R34) (98-08)											
2.0	114	RB20DE		06/98-07/00	VK16	5603	1.1	-	IK16TT	IK16TT	6
2.5	147	RB25DEH		06/98-07/00	VK16	5603	1.1	-	IK16TT	IK16TT	6
2.5 4x4	147	RB25DEH		06/98-07/00	VK16	5603	1.1	-	IK16TT	IK16TT	6
2.5 4x4 (ENR34)	147	RB25DEH		06/98-07/00	VK16	5603	1.1	-	IK16TT	IK16TT	6
2.5 Turbo	206	RB25DET		05/98-01/06	VK16	5603	1.1	-	IK16TT	IK16TT	6
2.6 Turbo 4x4	244			01/99-02/08	VQ20	5602	1.1	-	IQ20TT	IQ20TT	6
SKYLINE (V35) (03-)											
3.5 4x4	206	VQ35DE		08/03-	VKH16	5617	1.1	-	IKH16TT	IKH16TT	6
STANZA (81-85)											
1.6	60	CA16S		08/81-12/85	Q20PR-U	3007	0.8	Q20TT	IQ20TT	IQ20TT	4
1.8	65/66	CA18; CA18S		08/81-12/85	W20EPR-U	3047	0.8	W20TT	IW20TT	IW20TT	4
1.8 SGL	66	CA18S		03/83-12/85	W20EPR-U	3047	0.8	W20TT	IW20TT	IW20TT	4
SUNNY (70-82)											
1.2	38	A12		11/77-02/82	W14EPR-U	6011	0.8	-	IW16TT	IW16TT	4
1.4 (HBL310)	48	A14		11/77-02/82	W20EPR-U	3047	0.8	W20TT	IW20TT	IW20TT	4
SUNNY I (82-90)											
1.3	44	E13		03/82-08/90	W20EPR-U	3047	0.8	W20TT	IW20TT	IW20TT	4
1.5	55	E15S		03/82-10/86	W16EPR-U	3021	0.8	W16TT	IW16TT	IW16TT	4
1.6 4x4	66	E16I		07/86-10/88	W16EPR-U11	3201	1.1	W16TT	IW16TT	IW16TT	4
SUNNY II (86-91)											
1.0	37	E10S		07/86-09/90	W16EPR-U	3021	0.8	W16TT	IW16TT	IW16TT	4
1.3	44	E13S		06/86-10/91	W20EPR-U	3047	0.8	W20TT	IW20TT	IW20TT	4
1.4 LX	55	GA14S		10/88-08/91	Q20PR-U	3007	0.8	Q20TT	IQ20TT	IQ20TT	4
1.5	52	E15S		06/86-10/88	W16EPR-U	3021	0.8	W16TT	IW16TT	IW16TT	4
1.5	52	E15S	OEM Optional	06/86-06/87	W16EPR-U	3021	0.8	W16TT	IW16TT	IW16TT	4
1.6	62	E16S		06/86-10/88	W20EPR-U	3047	0.8	W20TT	IW20TT	IW20TT	4
1.6 GTI 16V	81	CA16D		05/87-05/89	PQ20R	3117	1.1	Q20TT	IQ20TT	IQ20TT	4
1.6 GTI 16V	81	CA16D		02/87-10/88	Q14R-U11	3183	1.1	-	IQ16TT	IQ16TT	4
1.6 i	54	E16i		06/86-05/89	W16EPR-U11	3201	1.1	W16TT	IW16TT	IW16TT	4
1.6 i 12V	66	GA16i		06/86-06/91	Q20PR-U11	3008	1.1	Q20TT	IQ20TT	IQ20TT	4
1.6 i 12V 4x4	66	GA16i		10/88-08/90	Q20PR-U11	3008	1.1	Q20TT	IQ20TT	IQ20TT	4
1.6 i 4x4 (A)	54	E16i		06/86-10/90	W16EPR-U11	3201	1.1	W16TT	IW16TT	IW16TT	4
1.7 D	40	CD17		01/86-06/91	DG-307		11V				4
1.8 GTI 16V	92	CA18D		01/89-06/91	PQ20R	3117	1.1	Q20TT	IQ20TT	IQ20TT	4
SUNNY III (90-00)											
1.4 i	55	GA14DE; GA14DS		10/90-05/95	K20PR-U	3145	0.8	K20TT	IK20TT	IK20TT	4
1.4 i 16V	64	GA14DE		10/90-06/95	K16PR-U	3191	0.8	K16TT	IK16TT	IK16TT	4
1.6	75	GA16DE		07/95-03/00	K16PR-U	3191	0.8	K16TT	IK16TT	IK16TT	4
1.6 i	66	GA16DE; GA16DEL; GA16DS		10/90-03/00	K20PR-U	3145	0.8	K20TT	IK20TT	IK20TT	4
1.6 i 16V	66/75	GA16DE		10/92-03/00	K16PR-U	3191	0.8	K16TT	IK16TT	IK16TT	4
1.6 i 16V 4WD	66	GA16DS		10/90-05/95	K20PR-U	3145	0.8	K20TT	IK20TT	IK20TT	4
1.6 i 16V 4x4	75	GA16DE		10/92-03/00	K20PR-U	3145	0.8	K20TT	IK20TT	IK20TT	4
1.6 L	75	GA16DE		11/92-04/96	K16PR-U	3191	0.8	K16TT	IK16TT	IK16TT	4
1.7 D	40	CD17		11/90-03/00	DG-307		11V				4
2.0 D	55	CD20		10/90-03/00	DG-304		11V				4
2.0 GTI 16V	105	SR20DE		10/90-05/95	PK20PR-L11	3142	1.1	-	IK20TT	IK20TT	4
2.0 GTI-R 4x4	162	SR20DET		10/90-05/95	PK20PR-P8	3245	0.8	-	IK20TT	IK20TT	4
2.0 i 16V	105	SR20DE		10/90-05/95	Q16PR-U11	5016	1.1	Q16TT	IQ16TT	IQ16TT	4
TEANA (03-08)											
2.0	103	QR20DE		04/06-06/08	VKH20	5618	1.1	-	IKH20TT	IKH20TT	4
2.3	127	VQ23DE		04/06-06/08	VKH16	5617	1.1	-	IKH16TT	IKH16TT	6
3.5	170	VQ35DE		04/06-06/08	VKH16	5617	1.1	-	IKH16TT	IKH16TT	6
TEANA (08-)											
2.5	134	VQ25DE		07/08-	FXE20HR11	3439	1.1	-	IXEH20TT	IXEH20TT	6
3.5	183	VQ35DE		07/08-	VFXEH22	5646	1.1	-	IXEH22TT	IXEH22TT	6
TERRANO I (87-96)											
2.4 i 4WD	76	Z24i		10/87-02/93	W16EPR-U	3021	0.8	W16TT	IW16TT	IW16TT	4
2.7 TD 4WD	73	TD27T		02/89-02/96	DG-137		11V				4
3.0 i 4WD	109	VG30E		01/90-02/93	K20R-U	3122	0.8	K20TT	IK20TT	IK20TT	6

Spark & Glow Plugs



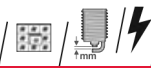



Application Tables







	KW										QTY
NISSAN <i>continued</i>											
TERRANO II (92-)											
2.4 4WD	85/87	KA24E		05/96-	K16GPR-U11	3135	1.1	-	-	-	4
2.4 i 12V 4WD	91	KA24E		02/93-06/96	K16GPR-U11	3135	1.1	-	-	-	4
2.7 TD 4WD	74	TD27T		02/93-01/02	DG-137		11V				4
2.7 TDi 4WD	92	TD27Ti		05/96-	DG-137		11V				4
2.7 TDi 4WD	92	TD27Ti		06/98-06/06	DG-307		11V				4
3.0 Di 4WD	113	ZD30		05/02-	DG-605		11V				4
TIIDA (04-)											
1.5	80	HR15DE		05/04-02/07	FXE20HE11	3436	1.1	-	IXEH20ETT	IXEH20ETT	4
1.5	80	HR15DE	OEM Optional	05/04-02/07	FXE16HE11	3438	1.1	-	-	FXE16HE11	4
1.5 4x4	80	HR15DE		05/04-02/07	FXE20HE11	3436	1.1	-	IXEH20ETT	IXEH20ETT	4
1.5 4x4	80	HR15DE	OEM Optional	05/04-02/07	FXE16HE11	3438	1.1	-	-	FXE16HE11	4
1.5 dCi	76/78	K9K 728; K9K 772		01/07-	DG-005		11V				4
1.6	81	HR16DE		09/07-	FXE20HR11	3439	1.1	-	IXEH20TT	IXEH20TT	4
1.8	81/93	HR18DE; MR18DE		05/04-	FXE20HR11	3439	1.1	-	IXEH20TT	IXEH20TT	4
1.8 4x4	81	HR18DE		05/04-02/07	FXE20HR11	3439	1.1	-	IXEH20TT	IXEH20TT	4
TITAN (03-)											
5.6	227	VK56DE		10/03-	VKH16	5617	1.1	-	IKH16TT	IKH16TT	8
5.6 4x4	227	VK56DE		10/03-	VKH16	5617	1.1	-	IKH16TT	IKH16TT	8
5.6 Flex-Fuel 4WD	227	VK56DE		10/03-12/06	VKH16	5617	1.1	-	IKH16TT	IKH16TT	8
TRADE (93-98)											
2.0 D	49	LD20		04/93-10/98	DG-307		11V				4
3.0 D	63/78	BD30II; BD-30Ti		01/94-12/98	DG-005		11V				4
TRADE (96-04)											
2.3 D	55	LD23		06/96-10/01	DG-137		11V				4
3.0 TD	81	BD-30Ti		11/98-09/04	DG-005		11V				4
3.0 TDIC	78	BD-30Ti		06/96-10/01	DG-005		11V				4
75	55	LD23		05/97-12/00	DG-137		11V				4
100	78	BD-30Ti		01/96-12/98	DG-005		11V				4
URVAN (81-98)											
2.0	64	Z20		05/87-05/97	W16EPR-U	3021	0.8	W16TT	IW16TT	IW16TT	4
2.0	55	H20		07/81-11/82	W20EPR-U	3047	0.8	W20TT	IW20TT	IW20TT	4
2.0 (E23B)	64	Z20		12/82-11/88	W16EPR-U	3021	0.8	W16TT	IW16TT	IW16TT	4
2.3 D	51	TD23		01/88-05/97	DG-198		11V				4
2.5 D	59	TD25		12/88-05/97	DG-198		11V				4
VANETTE (81-87)											
1.5	51	A15		04/87-12/87	W16EPR-U	3021	0.8	W16TT	IW16TT	IW16TT	4
1.5	51	A15		01/83-09/86	W20EPR-U	3047	0.8	W20TT	IW20TT	IW20TT	4
VANETTE (86-95)											
1.5	51	A15S		10/86-11/94	W16EPR-U	3021	0.8	W16TT	IW16TT	IW16TT	4
2.0	66	Z20S		07/87-01/90	W16EPR-U	3021	0.8	W16TT	IW16TT	IW16TT	4
2.0	66	Z20S		01/90-08/94	W20EPR-U	3047	0.8	W20TT	IW20TT	IW20TT	4
2.0 D	49	LD20II		07/91-01/95	DG-307		11V				4
2.0 D (ULC22)	47/49	LD20		10/86-12/95	DG-307		11V				4
2.4 i (SLC22)	74/77	Z24i		10/86-11/94	W16EPR-U	3021	0.8	W16TT	IW16TT	IW16TT	4
VANETTE CARGO (95-)											
1.6 i	71/72	GA16DE		01/95-11/01	K16PR-U	3191	0.8	K16TT	IK16TT	IK16TT	4
2.0 D	49	LD20		01/95-	DG-307		11V				4
2.3 D	55	LD23		01/95-	DG-137		11V				4
X-TRAIL (01-)											
2.0	103	QR20DE		07/01-03/07	K16HPR-U11	6076	1.1	KH16TT	IKH16TT	IKH16TT	4
2.0	110	QR20DE		09/01-03/07	K20HR-U11	3381	1.1	KH20TT	IKH20TT	IKH20TT	4
2.0 4x4	103	QR20DE		07/01-	K16HPR-U11	6076	1.1	KH16TT	IKH16TT	IKH16TT	4
2.0 4x4	110	QR20DE		09/01-03/07	K20HR-U11	3381	1.1	KH20TT	IKH20TT	IKH20TT	4
2.2 dCi	84/100	YD22DDTi		12/03-03/07	DG-197		11V				4
2.2 dCi 4x4	100	YD22DDTi		12/03-03/07	DG-197		11V				4
2.2 DCi FWD	84	YD22DDTi		06/01-09/03	DG-197		11V				4
2.2 Di 4x4	84	YD22ETi		07/01-	DG-197		11V				4
2.5 4x4	121	QR25DE		09/02-03/07	K16HPR-U11	6076	1.1	KH16TT	IKH16TT	IKH16TT	4
2.5 4x4	132	QR25DE		11/02-03/07	K20HR-U11	3381	1.1	KH20TT	IKH20TT	IKH20TT	4
X-TRAIL (07-)											
2.0	103/104	MR20DE		06/07-	FXE20HR11	3439	1.1	-	IXEH20TT	IXEH20TT	4
2.0 FWD	104	MR20DE		03/07-	FXE20HR11	3439	1.1	-	IXEH20TT	IXEH20TT	4
2.0 FWD	103	MR20DE	JJP	06/08-	FXE20HR11	3439	1.1	-	IXEH20TT	IXEH20TT	4
2.5 4x4	124	QR25DE		10/09-	FXE20HR11	3439	1.1	-	IXEH20TT	IXEH20TT	4
2.5 4x4	124	QR25DE		06/07-09/09	K16HPR-U11	6076	1.1	KH16TT	IKH16TT	IKH16TT	4







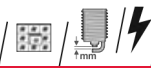



	KW								QTY
NISSAN CV									
ATLEON									
	78/87	BD-30Ti		09/00-	DG-005		11V		4
CABSTAR									
	96	YD25DDTi; YD25ETi		09/06-	DG-197		11V		4
	50/66	SD23; TD23; TD27		12/81-06/92	DG-198		11V		4
CABSTAR E									
	78/88	BD-30Ti		10/98-10/06	DG-005		11V		4
	55/66	LD23; TD27T		10/98-10/06	DG-137		11V		4
ECO-T									
	80	BD-30Ti		01/97-12/00	DG-005		11V		4
NSU									
TT (65-71)									
1.2	48			07/65-11/71	W22ESR-U	3098	0.8	-	4
TTS (70-71)									
1.0	52			01/70-11/71	W22ESR-U	3098	0.8	-	4
OPEL									
ADAM (12-)									
1.2	51	A 12 XEL		10/12-	KJ20CR-L11	3169	1.1	K20TT	4
1.4	64/74	A 14 XEL; A 14 XER		10/12-	KJ20CR-L11	3169	1.1	K20TT	4
1.4 LPG	64	A 14 XEL		07/13-	VK20T	5501	0.8	-	4
AGILA (00-07)									
1.0	44	Z10XEP(60)		08/03-12/07	KJ16CR-L11	3132	1.1	K16TT	3
1.0 12V	43	Z 10 XE		09/00-12/07	K20TXR	5063	1.0	K20TT	3
1.2 16V	55	Z 12 XE		09/00-12/07	K20TXR	5063	1.0	K20TT	4
1.2 16V Twinport	59	Z 12 XEP		07/04-12/07	KJ16CR-L11	3132	1.1	K16TT	4
1.3 CDTi	51	Z 13 DT		08/03-12/07	DG-171		11V		4
AGILA (08-)									
1.0	48/50	K10B		04/08-	ZXU20PR11	3452	1.1	-	3
1.0 LPG	48	K10B		01/10-	ZXU20PR11	3452	1.1	-	3
1.2	63/69	K12B		04/08-	ZXU20PR11	3452	1.1	-	4
1.2 LPG	63	K12B		04/08-	ZXU20PR11	3452	1.1	-	4
1.3 CDTi	55	Z 13 DTJ		04/08-	DG-171		11V		4
ANTARA (06-)									
2.0 CDTi	93/110	Z 20 DMH; Z 20 S		05/06-12/11	DG-604		4.4V		4
2.0 CDTi 4x4	110	Z 20 DMH; Z 20 S		05/06-12/11	DG-604		4.4V		4
2.4	123	A24XE		12/10-	ITL16	5349	1.1	-	4
2.4	103/104	Z 24 XE; Z 24 XED		05/06-	K20TXR	5063	1.0	K20TT	4
2.4 4x4	123	A24XE		12/10-	ITL16	5349	1.1	-	4
2.4 4x4	103	Z 24 XE		01/07-02/11	K20TXR	5063	1.0	K20TT	4
2.4 LPG	103	Z 24 XE	LPG / GPL	10/08-	VK20	5604	1.1	-	4
2.4 LPG 4x4	103	Z 24 XE	LPG / GPL	10/08-	VK20	5604	1.1	-	4
3.0	190	A 30 XH		11/10-	PT16VR13	5068	1.3	TV16TT	6
3.2 V6	167	10 HM; Z 32 SEE		03/07-	PT16VR13	5068	1.3	TV16TT	6
ARENA (97-01)									
1.9 D	44	F8Q 600; F8Q 606		03/98-08/01	DG-008		11V		4
2.5 D	55	S8U 758; S8U 780; S8U 782		03/98-08/01	DG-004		11.5V		4
ASCONA A (70-75)									
1.9 SR	65/66	19 S		10/70-08/75	W20FPR-U	3070	0.7	WF20TT	4
ASCONA B (75-81)									
1.3 N	44	13 N		03/79-08/81	W20EPR-U	3047	0.8	W20TT	4
1.3 S	55	13 S		08/79-08/81	W20EPR-U	3047	0.8	W20TT	4
1.6 N	44	16 N		09/75-08/81	W20FP-U	3068	0.7	WF20TT	4
1.6 S	55	16 S		09/75-08/81	W20FP-U	3068	0.7	WF20TT	4
1.9 N	55	19 N		08/76-08/81	W20FP-U	3068	0.7	WF20TT	4
1.9 S	66	19 S		09/75-08/81	W20FP-U	3068	0.7	WF20TT	4
2.0 D	43	20 D	Eng: 90310>	11/79-08/81	DG-001		11V		4
2.0 E	81	20 E		08/79-08/81	W20FP-U	3068	0.7	WF20TT	4
2.0 N	66	20 N		08/77-08/81	W20FPR-U	3070	0.7	WF20TT	4
2.0 S	74	20 S		08/77-08/81	W20FPR-U	3070	0.7	WF20TT	4
ASCONA C (81-88)									
1.3 N	44	13 N		09/81-08/86	W20EPR-U	3047	0.8	W20TT	4
1.3 S	55	13 S		09/81-08/88	W20EPR-U	3047	0.8	W20TT	4
1.6	60	16 SV		09/86-08/88	W20EPR-U	3047	0.8	W20TT	4
1.6	55	16 N		09/81-08/88	W20FP-U	3068	0.7	WF20TT	4
1.6 D	40	16 D; 16 DA		03/82-08/88	DG-001		11V		4







Spark & Glow Plugs











Application Tables







	KW				Standard 			Twin Tip 			QTY
OPEL continued											
ASCONA C (81-88) continued											
1.6 i	55	E 16 NZ		09/87-08/88	W16EPR-U	3021	0.8	W16TT	IW16TT	IW16TT	4
1.6 i CAT	55	C 16 NZ		09/86-08/88	K20TXR	5063	1.0	K20TT	IK20TT	IK20TT	4
1.6 S	66	16 SH		09/81-08/86	W20EPR-U	3047	0.8	W20TT	IW20TT	IW20TT	4
1.8	62	E 18 NV		09/87-08/88	W20EPR-U	3047	0.8	W20TT	IW20TT	IW20TT	4
1.8 E	74	C 18 NE; S 18 NV		01/85-08/86	W20EPR-U	3047	0.8	W20TT	IW20TT	IW20TT	4
1.8 i	85	18 E		09/82-08/86	W20EPR-U	3047	0.8	W20TT	IW20TT	IW20TT	4
2.0 i	74	C20NE(100)		08/87-08/88	W20EPR-U	3047	0.8	W20TT	IW20TT	IW20TT	4
2.0 i	85	20 NE	Ch: P7000001, R1000001, R5000001>	09/86-08/88	K20TXR	5063	1.0	K20TT	IK20TT	IK20TT	4
2.0 i	85	20 NE	Ch: P7000001, R5000001, R1000001>	09/86-08/88	K20TXR	5063	1.0	K20TT	IK20TT	IK20TT	4
2.0 i CAT	85	C 20 NE	Ch: P7000001, R1000001, R5000001>	09/86-08/88	K20TXR	5063	1.0	K20TT	IK20TT	IK20TT	4
2.0 i CAT	85	C 20 NE	Ch: R5000001, R1000001, P7000001>	09/86-08/88	K20TXR	5063	1.0	K20TT	IK20TT	IK20TT	4
2.0 i GT	95	20 SEH		03/87-08/88	W20EPR-U	3047	0.8	W20TT	IW20TT	IW20TT	4
ASTRA F (91-01)											
1.4	55/60	14 NV; 14 SE	Ch: >02BF1476	09/91-09/98	W20EPR-U	3047	0.8	W20TT	IW20TT	IW20TT	4
1.4	55/60	14 NV; 14 SE	Ch: 02BF1477>	09/91-09/98	K20TXR	5063	1.0	K20TT	IK20TT	IK20TT	4
1.4 i	44	C 14 NZ; X 14 NZ	Ch: >02BF1476	09/91-09/98	W20EPR-U	3047	0.8	W20TT	IW20TT	IW20TT	4
1.4 i	44	C 14 NZ; X 14 NZ	Ch: 02BF1477>	09/91-09/98	K20TXR	5063	1.0	K20TT	IK20TT	IK20TT	4
1.4 i 16V	66	X 14 XE		01/96-09/98	K20TXR	5063	1.0	K20TT	IK20TT	IK20TT	4
1.4 Si	60	C 14 SE	Ch: >02BF1476	03/92-03/01	W20EPR-U	3047	0.8	W20TT	IW20TT	IW20TT	4
1.4 Si	60	C 14 SE	Ch: 02BF1477>	03/92-03/01	K20TXR	5063	1.0	K20TT	IK20TT	IK20TT	4
1.6	55	16 LZ2; 16 NZR		09/95-09/98	K20TXR	5063	1.0	K20TT	IK20TT	IK20TT	4
1.6 i	52/55	C 16 NZ; X 16 SZ; X 16 SZR	Ch: >02BF1476	02/93-03/01	W20EPR-U	3047	0.8	W20TT	IW20TT	IW20TT	4
1.6 i	52/55	C 16 NZ; X 16 SZ; X 16 SZR	Ch: 02BF1477>	02/93-03/01	K20TXR	5063	1.0	K20TT	IK20TT	IK20TT	4
1.6 i 16V	74	X 16 XEL		08/94-09/98	K20TXR	5063	1.0	K20TT	IK20TT	IK20TT	4
1.6 i 16V	74	X 16 XEL	Ch: >02BF1476	08/94-01/98	W20EPR-U	3047	0.8	W20TT	IW20TT	IW20TT	4
1.6 i 16V	74	X 16 XEL	Ch: 02BF1477>	08/94-01/98	K20TXR	5063	1.0	K20TT	IK20TT	IK20TT	4
1.6 Si	74	C 16 SE	Ch: >02BF1476	03/92-12/94	W20EPR-U	3047	0.8	W20TT	IW20TT	IW20TT	4
1.6 Si	74	C 16 SE	Ch: 02BF1477>	03/92-12/94	K20TXR	5063	1.0	K20TT	IK20TT	IK20TT	4
1.7 D	42/ 44/ 50	17 D; 17 DR; X 17 DTL		03/92-08/96	DG-001		11V				4
1.7 TD	50	X 17 DTL		08/94-01/99	DG-001		11V				4
1.7 TDS	60	17 DT (TC4EE1)	Eng: >956632	12/91-09/98	DG-104		11V				4
1.7 TDS	60	17 DT (TC4EE1)	Eng: 956633>	12/91-09/98	DG-300		11V				4
1.8 i	66	C 18 NZ	Ch: >02BF1476	09/91-09/98	W20EPR-U	3047	0.8	W20TT	IW20TT	IW20TT	4
1.8 i	66	C 18 NZ	Ch: 02BF1477>	09/91-09/98	K20TXR	5063	1.0	K20TT	IK20TT	IK20TT	4
1.8 i 16V	82/ 85/ 92	18 SE; C 18 SEL; C 18 XEL; X 18 XE		06/93-09/96	K20TXR	5063	1.0	K20TT	IK20TT	IK20TT	4
2.0 GSI 16V	110	C 20 XE	Ch: >02BF1476	09/91-01/98	W20EPR-U	3047	0.8	W20TT	IW20TT	IW20TT	4
2.0 GSI 16V	110	C 20 XE	Ch: 02BF1477>	09/91-01/98	K20TXR	5063	1.0	K20TT	IK20TT	IK20TT	4
2.0 i	85	C 20 NE	Ch: >02BF1476	09/91-09/98	W20EPR-U	3047	0.8	W20TT	IW20TT	IW20TT	4
2.0 i	85	C 20 NE	Ch: 02BF1477>	09/91-09/98	K20TXR	5063	1.0	K20TT	IK20TT	IK20TT	4
2.0 i 16V	100	X 20 XEV		02/95-09/98	K20TXR	5063	1.0	K20TT	IK20TT	IK20TT	4
2.0 i 16V	100/ 110	C 20 XE; X 20 XEV	Ch: >02BF1476	03/93-01/98	W20EPR-U	3047	0.8	W20TT	IW20TT	IW20TT	4
2.0 i 16V	100/ 110	C 20 XE; X 20 XEV	Ch: 02BF1477>	03/93-01/98	K20TXR	5063	1.0	K20TT	IK20TT	IK20TT	4







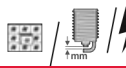



	KW								QTY		
OPEL <i>continued</i>											
ASTRA F CLASSIC (98-05)											
1.2 i	48	X 12 XE		03/98-08/00	K20TXR	5063	1.0	K20TT	IK20TT	IK20TT	4
1.4 i	44/66	X 14 NZ; X 14 XE		01/98-01/05	K20TXR	5063	1.0	K20TT	IK20TT	IK20TT	4
1.6 i	55	X 16 SZR		01/98-01/05	K20TXR	5063	1.0	K20TT	IK20TT	IK20TT	4
1.6 i 16V	74	X 16 XEL		01/98-01/05	K20TXR	5063	1.0	K20TT	IK20TT	IK20TT	4
1.7 TD	50	X 17 DTL		03/98-08/00	DG-001		11V				4
1.8	81	Z 18 XEL		02/03-07/04	K20TXR	5063	1.0	K20TT	IK20TT	IK20TT	4
1.8 i	85	X 18 XE1		03/98-08/00	K20TXR	5063	1.0	K20TT	IK20TT	IK20TT	4
2.0 Di	60	X 20 DTL		03/98-08/00	DG-118		11V				4
2.0 DTi	74	X 20 DTH		08/99-08/00	DG-118		11V				4
2.0 i	100/118	X 20 XER; X 20 XEV		03/98-08/00	K20TXR	5063	1.0	K20TT	IK20TT	IK20TT	4
ASTRA G (98-09)											
1.2 16V	48/55	X 12 XE; Z 12 XE		02/98-07/04	K20TXR	5063	1.0	K20TT	IK20TT	IK20TT	4
1.4	66	Z 14 XEP		09/07-12/09	K20TXR	5063	1.0	K20TT	IK20TT	IK20TT	4
1.4 16V	66	X 14 XE; Z 14 XE	Ch: >42000000, 45000000, 48000000, 4B000000	02/98-01/05	K20TXR	5063	1.0	K20TT	IK20TT	IK20TT	4
1.4 16V	66	X 14 XE; Z 14 XE	Ch: 42000001, 45000001, 46000001, 48000001, 4B000001>	02/98-01/05	KJ16CR-L11	3132	1.1	K16TT	IK16TT	IK16TT	4
1.6	55/ 62/ 70/ 76	X 16 SZR; Z 16 SE; Z 16 XEP; Z 16 YNG; Z16SE/E2(85)		01/99-12/09	K20TXR	5063	1.0	K20TT	IK20TT	IK20TT	4
1.6	76	Z 16 XEP	Ch: 42000001, 45000001, 46000001, 48000001, 4B000001>	12/02-12/09	KJ16CR-L11	3132	1.1	K16TT	IK16TT	IK16TT	4
1.6	76	Z 16 XEP	Ch: >42000000, 45000000, 48000000, 4B000000	12/02-12/09	K20TXR	5063	1.0	K20TT	IK20TT	IK20TT	4
1.6 16V	74	C 16 SEL; X 16 XEL; Z 16 XE		02/98-05/05	K20TXR	5063	1.0	K20TT	IK20TT	IK20TT	4
1.6 16V	74/76	Z 16 XE; Z 16 XEP	Ch: >42000000, 45000000, 48000000, 4B000000	03/00-10/05	K20TXR	5063	1.0	K20TT	IK20TT	IK20TT	4
1.6 16V	74/76	Z 16 XE; Z 16 XEP	Ch: 42000001, 45000001, 46000001, 48000001, 4B000001>	03/00-10/05	KJ16CR-L11	3132	1.1	K16TT	IK16TT	IK16TT	4
1.6 CNG	71	Z 16 YNG		03/03-07/04	IK20L	5358	1.1	-	IK20TT	IK20TT	4
1.6 LPG	74	Z 16 XE		06/02-01/05	K20TXR	5063	1.0	K20TT	IK20TT	IK20TT	4
1.7 CDTi	59	Z 17 DTL		04/03-12/09	DG-302		11V				4
1.7 DTi 16V	55	Y 17 DT		02/00-01/05	DG-302		11V				4
1.7 TD	50	X 17 DTL		09/98-04/05	DG-001		11V				4
1.8 16V	85/92	X 18 XE1; Z 18 XE		02/98-07/04	K20TXR	5063	1.0	K20TT	IK20TT	IK20TT	4
2.0 16V	100	C 20 SEL; X 20 XEV		02/98-01/05	K20TXR	5063	1.0	K20TT	IK20TT	IK20TT	4
2.0 16V OPC	118	X 20 XER		11/99-09/02	K20TXR	5063	1.0	K20TT	IK20TT	IK20TT	4
2.0 16V Turbo	140/ 141/ 147	Z 20 LET		09/00-10/05	K20TXR	5063	1.0	K20TT	IK20TT	IK20TT	4
2.0 DI	60	X 20 DTL; Y 20 DTL		09/98-04/05	DG-118		11V				4
2.0 DTi 16V	74	Y 20 DTH		08/99-08/02	DG-118		11V				4
2.0 DTi 16V	74	Y 20 DTH		09/02-01/05	DG-142		11V				4
2.0 OPC	141/ 147	Z 20 LET		03/02-10/05	K20TXR	5063	1.0	K20TT	IK20TT	IK20TT	4
2.2 16V	108	Z 22 SE		09/00-05/05	PT16VR13	5068	1.3	TV16TT	ITV16TT	ITV16TT	4
2.2 DTi	86/92	Y 22 DTR		09/02-10/05	DG-142		11V				4
ASTRA H (04-)											
1.2	59	Z 12 XEP		08/05-	KJ16CR-L11	3132	1.1	K16TT	IK16TT	IK16TT	4
1.3 CDTi	66	Z 13 DTH		08/05-	DG-171		11V				4
1.4	55/ 59/ 66	Z 14 XEL; Z 14 XEP; Z14XEL		08/04-	KJ16CR-L11	3132	1.1	K16TT	IK16TT	IK16TT	4
1.4 LPG	66	Z 14 XEP		08/09-	KJ20CR-L11	3169	1.1	K20TT	IK20TT	IK20TT	4
1.6	76/77	Z 16 XE1; Z 16 XEP		02/04-	KJ20CR-L11	3169	1.1	K20TT	IK20TT	IK20TT	4







	KW											QTY
OPEL continued												
ASTRA H (04-) continued												
1.6	85	A 16 XER; Z 16 XER	Ch: >92999999; 95999999; 98999999; 9G999999; 9B999999	12/06-	KJ16CR-L11	3132	1.1		K16TT	IK16TT	IK16TT	4
1.6	85	A 16 XER; Z 16 XER	Ch: A2000001; A8000001; AG000001>	12/06-	KJ20CR-L11	3169	1.1		K20TT	IK20TT	IK20TT	4
1.6 LPG	85	Z 16 XER	Ch: >92999999; 95999999; 98999999; 9G999999; 9B999999	08/09-	KJ16CR-L11	3132	1.1		K16TT	IK16TT	IK16TT	4
1.6 LPG	85	Z 16 XER	Ch: A2000001; A8000001; AG000001>	08/09-	KJ20CR-L11	3169	1.1		K20TT	IK20TT	IK20TT	4
1.6 Turbo	132	Z 16 LET; Z16LET(180)		02/07-09/10	IK20L	5358	1.1	-		IK20TT	IK20TT	4
1.6 Turbo	132	Z 16 LET; Z16LET(180)		02/07-	KJ16CR-L11	3132	1.1		K16TT	IK16TT	IK16TT	4
1.7 CDTI	59/ 74/ 81/ 92	A 17 DTJ; A 17 DTR; Z 17 DTH; Z 17 DTJ; Z 17 DTL; Z 17 DTR		03/04-	DG-302		11V					4
1.8	92	Z 18 XE		03/04-	KJ16CR-L11	3132	1.1		K16TT	IK16TT	IK16TT	4
1.8	103	A 18 XER; Z 18 XER	Ch: >D2999999; D5999999; D8999999; DG999999; 9B999999	01/06-	KJ16CR-L11	3132	1.1		K16TT	IK16TT	IK16TT	4
1.8	103	A 18 XER; Z 18 XER	Ch: E2000001; E8000001; EG000001>	01/06-	KJ20CR-L11	3169	1.1		K20TT	IK20TT	IK20TT	4
1.9 CDTi	103/ 110	Z 19 DTH		12/04-	DG-170		11V					4
1.9 CDTI	74/88	Z 19 DTL	Ch: >72045139;750 30986;7800739 1	09/05-	DG-122		11V					4
1.9 CDTI	74/88	Z 19 DTL	Ch: 72045140:7503 0987;78007392 ;8B000001>	09/05-	DG-196		11V					4
1.9 CDTi 16V	88	Z 19 DTJ		08/04-	DG-170		11V					4
2.0 Turbo	125/ 147	Z 20 LEL; Z 20 LER		03/04-	KJ16CR-L11	3132	1.1		K16TT	IK16TT	IK16TT	4
2.0 Turbo	177	Z 20 LEH		03/05-	PK20PR-P8	3245	0.8	-		IK20TT	IK20TT	4
ASTRA J (09-)												
1.3 CDTI	70	A 13 DTE		12/09-	DG-621		4.4V					4
1.4	64/74	A 14 XEL; A 14 XER		12/09-	KJ20CR-L11	3169	1.1		K20TT	IK20TT	IK20TT	4
1.6	132	A16LET		10/11-	IK20L	5358	1.1	-		IK20TT	IK20TT	4
1.6	85	A 16 XER		12/09-	KJ20CR-L11	3169	1.1		K20TT	IK20TT	IK20TT	4
1.6 LPG	84	A 16 XER		10/12-	KJ20CR-L11	3169	1.1		K20TT	IK20TT	IK20TT	4
1.6 Turbo	132	A 16 LET; A16LET		12/09-	IK20L	5358	1.1	-		IK20TT	IK20TT	4
1.7 CDTI	74/ 81/ 92	A 17 DTC; A 17 DTE; A 17 DTJ; A 17 DTL; A 17 DTN; A 17 DTR		12/09-	DG-302		11V					4
1.8	103	A 18 XER		10/11-	KJ20CR-L11	3169	1.1		K20TT	IK20TT	IK20TT	4
2.0	206	A 20 NFT		04/12-	ITV20	5339	1.1	-		ITV20TT	ITV20TT	4
2.0 BiTurbo CDTI	143	A 20 DTR	Stop & Start(-), Ch: >B3999999;B8 999999;BG999 999	10/12-	DG-608		4.4V					4
2.0 CDTI	118/ 121	A 20 DTH	Stop & Start(-), Ch: >B3999999;B8 999999;BG999 999	10/10-	DG-608		4.4V					4
CALIBRA (90-97)												
2.0 i	85	C 20 NE		07/93-07/97	K20TXR	5063	1.0		K20TT	IK20TT	IK20TT	4
2.0 i	85	C 20 NE		06/90-06/93	W16EPR-U	3021	0.8		W16TT	IW16TT	IW16TT	4
2.0 i 16V	100/ 110	C 20 XE; X 20 XEV		06/90-07/97	K20TXR	5063	1.0		K20TT	IK20TT	IK20TT	4
2.0 i 16V 4x4	100/ 110	C 20 XE; X 20 XEV		06/90-07/97	K20TXR	5063	1.0		K20TT	IK20TT	IK20TT	4
2.0 i 4x4	85	C 20 NE		07/93-07/97	K20TXR	5063	1.0		K20TT	IK20TT	IK20TT	4









	KW					Standard		Twin Tip		QTY	
OPEL <i>continued</i>											
CALIBRA (90-97) <i>continued</i>											
2.0 i 4x4	85	C 20 NE		06/90-06/93	W16EPR-U	3021	0.8	W16TT	IW16TT	IW16TT	4
2.0 i Turbo 4x4	150	C 20 LET		03/92-07/97	KJ20CR-U11	3451	1.1	K20TT	IK20TT	IK20TT	4
2.5 i V6	125	C 25 XE; X 25 XE		04/93-07/97	K20TXR	5063	1.0	K20TT	IK20TT	IK20TT	6
CAMPO (87-)											
2.2 D (TFR52)	39/45	C223		08/87-09/96	DG-124		11V				4
2.2 D 4x4 (TFS52)	39/45	C223		08/87-09/96	DG-124		11V				4
2.3 (TFR16)	69/72	4ZDI		08/91-09/96	W20EPR-U11	3049	1.1	W20TT	IW20TT	IW20TT	4
2.3 4x4 (TFS16)	69/72	4ZDI		08/91-09/96	W20EPR-U11	3049	1.1	W20TT	IW20TT	IW20TT	4
2.5 D (TFR54)	56	4 JA1		08/91-06/94	DG-108		11V				4
2.5 D 4x4 (TFS54)	56	4 JA1		08/91-06/94	DG-108		11V				4
2.5 DTI	74	4 JA1		12/01-	DG-108		11V				4
2.5 DTI 4x4	74	4 JA1		12/01-	DG-108		11V				4
2.5 TD (TFR54)	56	4 JA1T		07/94-	DG-108		11V				4
2.5 TD 4x4 (TFS54)	56	4 JA1T		07/94-	DG-108		11V				4
3.1 TD (TFR69)	80	4 JG2T		12/92-	DG-104		11V				4
3.1 TD 4x4 (TFS69)	80	4 JG2T		12/92-	DG-104		11V				4
COMBO (94-01)											
1.2	33	X12SZ	Ch: > 19334656, 19341712	07/94-10/01	W16EPR-U	3021	0.8	W16TT	IW16TT	IW16TT	4
1.2	33	C12NZ;X12SZ	Ch: 19K87118>	07/94-10/01	K20TXR	5063	1.0	K20TT	IK20TT	IK20TT	4
1.4	44/60	C 14 NZ; C 14 SE; X 14 SZ		07/94-10/01	K20TXR	5063	1.0	K20TT	IK20TT	IK20TT	4
1.4 16V	66	X 14 XE		08/99-10/01	K20TXR	5063	1.0	K20TT	IK20TT	IK20TT	4
1.7 D	44	17 D (4EE1); X 17 D (4EE1)		07/94-10/01	DG-300		11V				4
COMBO (01-)											
1.3 CDTI 16V	51/55	Y 13 DT; Z 13 DT; Z 13 DTJ		10/04-	DG-171		11V				4
1.4	66	Z 14 XEP		10/04-	KJ16CR-L11	3132	1.1	K16TT	IK16TT	IK16TT	4
1.4 16V	66	Z 14 XEP		08/05-	KJ16CR-L11	3132	1.1	K16TT	IK16TT	IK16TT	4
1.6	64	Z 16 SE		10/01-	K20TXR	5063	1.0	K20TT	IK20TT	IK20TT	4
1.6 CNG	69/71	Z 16 YNG	LPG / GPL	04/05-	PK20PR-P8	3245	0.8	-	IK20TT	IK20TT	4
1.6 CNG 16V	69	Z 16 YNG		06/06-	PK20PR-P8	3245	0.8	-	IK20TT	IK20TT	4
1.6 CNG 16V	69/71	Z 16 YNG; Z16YNG(96)	LPG / GPL	04/05-	PK20PR-P8	3245	0.8	-	IK20TT	IK20TT	4
1.7 CDTI 16V	74	Z 17 DTH		12/04-	DG-302		11V				4
1.7 DI 16V	48	Y 17 DTL		10/01-	DG-302		11V				4
1.7 DTI 16V	55	Y 17 DT		10/01-	DG-302		11V				4
COMBO (12-)											
1.3 CDTI	66	A 13 FD		02/12-	DG-621		4.4V				4
1.4	70/88	A 14 FC; A 14 FP		02/12-	XU22EPR-U	3179	0.9	XU22TT	-	VXU22	4
1.4 CNG	88	A 14 FC		02/12-	VXU22	5608	0.9	-	-	VXU22	4
1.6 CDTI	66/ 74/ 77	A 16 FDH; A 16 FDL		02/12-	DG-608		4.4V				4
2.0 CDTI	99	A 20 FD		02/12-	DG-608		4.4V				4
COMMODORE C (78-82)											
2.5 E	96	25E		12/80-12/82	W16EPR-U	3021	0.8	W16TT	IW16TT	IW16TT	6
2.5 S	85	25S		08/78-12/82	W16EPR-U	3021	0.8	W16TT	IW16TT	IW16TT	6
CORSA A (82-93)											
1.0	33	10 S		02/86-04/89	W20FPR-U	3070	0.7	WF20TT	-	-	4
1.0	33	10 S		09/82-03/93	W20FP-U	3068	0.7	WF20TT	-	-	4
1.2	40	12 ST		02/86-04/89	W20EPR-U	3047	0.8	W20TT	IW20TT	IW20TT	4
1.2	33	E 12 GV		09/82-08/90	W20FPR-U	3070	0.7	WF20TT	-	-	4
1.2	44	12 S		09/82-08/90	W20FP-U	3068	0.7	WF20TT	-	-	4
1.2 i	33	C 12 NZ	Eng: 19341713>	09/89-03/93	K20TXR	5063	1.0	K20TT	IK20TT	IK20TT	4
1.2 N	38	12 NV		01/90-03/93	W16EPR-U	3021	0.8	W16TT	IW16TT	IW16TT	4
1.2 N	33	E 12 GV		01/85-10/87	W20FPR-U	3070	0.7	WF20TT	-	-	4
1.2 S	40	12 ST		09/82-03/93	W20EPR-U	3047	0.8	W20TT	IW20TT	IW20TT	4
1.3	44/51	13 NB; 13 SB; C 13 N		02/86-04/89	W20EPR-U	3047	0.8	W20TT	IW20TT	IW20TT	4
1.3 i	44	C 13 N		09/86-09/90	W20EPR-U	3047	0.8	W20TT	IW20TT	IW20TT	4
1.3 S	51	13 SB		09/82-10/89	W20EPR-U	3047	0.8	W20TT	IW20TT	IW20TT	4
1.4 i	44	C 14 NZ	Eng: 02BF1476;192 416 23>	10/89-03/93	K20TXR	5063	1.0	K20TT	IK20TT	IK20TT	4









	KW										QTY
OPEL <i>continued</i>											
CORSA A (82-93) <i>continued</i>											
1.4 S	53	14 NV	Eng: >02BF1476	09/89-03/93	W20EPR-U	3047	0.8	W20TT	IW20TT	IW20TT	4
1.4 Si	60	C 14 SE	Eng: 02BD1414>	09/91-03/93	K20TXR	5063	1.0	K20TT	IK20TT	IK20TT	4
1.5 D	37	15 D (4EC1)	Eng: >804794	06/87-11/92	DG-143		5V				4
1.5 D	37	15 D (4EC1)	Eng: 804795>	06/87-11/92	DG-124		11V				4
1.5 TD	49	15 DT (T4EC1)	Eng: >804794	10/87-03/93	DG-159		5V				4
1.5 TD	49	15 DT (T4EC1)	Eng: 804795>	10/87-03/93	DG-104		11V				4
1.6 GSI	55/ 72/ 74	C 16 NZ; C 16 SEI; E 16 SE		05/88-09/92	W20EPR-U	3047	0.8	W20TT	IW20TT	IW20TT	4
1.6 GSI CAT	74	C 16 SE		02/92-03/93	W20EPR-U	3047	0.8	W20TT	IW20TT	IW20TT	4
CORSA B (93-00)											
1.0 i 12V	40	X 10 XE		11/96-09/00	K20TXR	5063	1.0	K20TT	IK20TT	IK20TT	3
1.2 i	33	12 NZ; C 12 NZ; X 12 SZ	Ch: >19334656, 19341717	03/93-09/00	W16EPR-U	3021	0.8	W16TT	IW16TT	IW16TT	4
1.2 i	33	12 NZ; C 12 NZ; X 12 SZ	Ch: 19K87118>	03/93-09/00	K20TXR	5063	1.0	K20TT	IK20TT	IK20TT	4
1.2 i 16V	48	X 12 XE		03/98-09/00	K20TXR	5063	1.0	K20TT	IK20TT	IK20TT	4
1.4 i	40/44	C 14 NZ; C14NZ;X14SZ; X 14 SZ		08/95-09/00	K20TXR	5063	1.0	K20TT	IK20TT	IK20TT	4
1.4 i	40/44	C14NZ		03/93-07/95	W16EPR-U	3021	0.8	W16TT	IW16TT	IW16TT	4
1.4 i 16V	67	X 14 XE		09/94-08/99	K20PBR-S10	5061	1.0	K20TT	IK20TT	IK20TT	4
1.4 i 16V	63/66	C 14 SEL; X 14 XE		09/94-09/00	K20TXR	5063	1.0	K20TT	IK20TT	IK20TT	4
1.4 Si	60	C 14 SE	Ch: >02BD1413, 19263161	03/93-09/00	W16EPR-U	3021	0.8	W16TT	IW16TT	IW16TT	4
1.4 Si	60	C 14 SE	Ch: 02LP3953, 19K87118, X6000001>	03/93-09/00	K20TXR	5063	1.0	K20TT	IK20TT	IK20TT	4
1.5 D	37	15 D (4EC1)		03/93-09/00	DG-300		11V				4
1.5 TD	49	15 DT (T4EC1); X 15 DT (T4EC1)		03/93-09/00	DG-300		11V				4
1.6 GSI 16V	80	C 16 XE		03/93-09/00	K20TXR	5063	1.0	K20TT	IK20TT	IK20TT	4
1.6 i 16V	74/78	C 16 SEL; X 16 XE		09/94-09/00	K20TXR	5063	1.0	K20TT	IK20TT	IK20TT	4
1.7 D	44	17 D (4EE1); X 17 D (4EE1)		02/96-09/00	DG-300		11V				4
CORSA C (00-09)											
1.0	43	Z 10 XE		09/00-12/09	K20TXR	5063	1.0	K20TT	IK20TT	IK20TT	3
1.0	44	Z 10 XEP		06/03-12/09	KJ16CR-L11	3132	1.1	K16TT	IK16TT	IK16TT	3
1.2	55	Z 12 XE		09/00-12/09	K20TXR	5063	1.0	K20TT	IK20TT	IK20TT	4
1.2	59	Z 12 XEP		07/05-	KJ16CR-L11	3132	1.1	K16TT	IK16TT	IK16TT	4
1.2 16V	55	Z 12 XE		09/00-	K20TXR	5063	1.0	K20TT	IK20TT	IK20TT	4
1.2 Twinport	59	Z 12 XEP		07/04-12/09	KJ16CR-L11	3132	1.1	K16TT	IK16TT	IK16TT	4
1.3 CDTI	51	Z 13 DT		06/03-12/09	DG-171		11V				4
1.3 CDTI 16V	51	Z 13 DT		08/05-	DG-171		11V				4
1.4	66	Z 14 XE		09/00-12/09	K20TXR	5063	1.0	K20TT	IK20TT	IK20TT	4
1.4	66	Z 14 XEP		08/03-	KJ16CR-L11	3132	1.1	K16TT	IK16TT	IK16TT	4
1.4 Twinport	66	Z 14 XEP		06/03-12/09	KJ16CR-L11	3132	1.1	K16TT	IK16TT	IK16TT	4
1.7 CDTI	74	Z 17 DTH		06/03-	DG-302		11V				4
1.7 DI	48	Y 17 DTL		09/00-12/09	DG-302		11V				4
1.7 DI 16V	48	Y 17 DTL		09/00-	DG-302		11V				4
1.7 DTI	55	Y 17 DT		09/00-12/09	DG-302		11V				4
1.7 DTI 16V	55	Y 17 DT		09/00-	DG-302		11V				4
1.8	92	Z 18 XE		09/00-12/09	K20TXR	5063	1.0	K20TT	IK20TT	IK20TT	4
CORSA D (06-)											
1.0	44/48	A 10 XEP		07/06-	KJ16CR-L11	3132	1.1	K16TT	IK16TT	IK16TT	3
1.0	44	Z 10 XEP		07/06-	KJ20CR-L11	3169	1.1	K20TT	IK20TT	IK20TT	3
1.2	59	Z 12 XEP		07/06-	KJ16CR-L11	3132	1.1	K16TT	IK16TT	IK16TT	4
1.2	51/63	A 12 XEL; A 12 XER		06/10-	KJ20CR-L11	3169	1.1	K20TT	IK20TT	IK20TT	4
1.2 LPG	59	Z 12 XEP		09/09-	KJ20CR-L11	3169	1.1	K20TT	IK20TT	IK20TT	4
1.2 LPG	61/63	A 12 XER		06/11-	VK20T	5501	0.8	-	IK20TT	IK20TT	4
1.3 CDTI	55/66	Z 13 DTH; Z 13 DTJ		07/06-	DG-171		11V				4
1.3 CDTI	70	A 13 DTE; A 13 DTR; Z 13 DTE		06/10-	DG-621		4.4V				4

	KW								QTY		
OPEL <i>continued</i>											
CORSA D (06-) <i>continued</i>											
1.4	66	Z 14 XEP		07/06-	KJ16CR-L11	3132	1.1	K16TT	IK16TT	IK16TT	4
1.4	64/74	A 14 XEL; A 14 XER		09/09-	KJ20CR-L11	3169	1.1	K20TT	IK20TT	IK20TT	4
1.4 LPG	66	Z 14 XEP		07/06-	KJ20CR-L11	3169	1.1	K20TT	IK20TT	IK20TT	4
1.4 LPG	64	A 14 XEL		09/09-	VK20T	5501	0.8	-	IK20TT	IK20TT	4
1.6 Turbo	110/ 141/ 155	A 16 LES; A16LEL; A16LER; B 16 LES		02/07-	IK20L	5358	1.1	-	IK20TT	IK20TT	4
1.6 Turbo	141	Z16LER(192)		02/07-	PK20PR-L11	3142	1.1	-	IK20TT	IK20TT	4
1.7 CDTI	92/96	A 17 DTS; Z 17 DTR		07/06-	DG-302		11V				4
FRONTERA A (92-98)											
2.0 i (52SUD2, 55SUD2)	85	C 20 NE; X 20 SE	Ch: P7000001, R1000001, R5000001>	03/92-10/98	K20TXR	5063	1.0	K20TT	IK20TT	IK20TT	4
2.2 i (54MWL4)	100	X 22 XE		03/95-10/98	K20TXR	5063	1.0	K20TT	IK20TT	IK20TT	4
2.3 TD (5JMWL4)	74	23 DTR		03/92-10/98	DG-001		11V				4
2.4 i (53MWL4)	92	C 24 NE		03/92-02/95	W20FPR-U	3070	0.7	WF20TT	-	-	4
2.5 TDS	85	25TDS (VM41B)		09/96-10/98	DG-109		11V				4
2.8 TD (53SUD2)	83	28 TDI (4JB1T)		03/95-08/96	DG-108		11V				4
2.8 TD (5BMWL4)	83	28 TDI (4JB1T)		03/95-10/98	DG-108		11V				4
FRONTERA B (98-)											
2.2 DTI	88	Y 22 DTH	Ch: 1V500001>	09/02-	DG-142		11V				4
2.2 DTI (6B_ZC, 6B_VF, 6B_66, 6B_76)	85	X22DTH	Ch: >YV699999	10/98-09/02	DG-118		11V				4
2.2 DTI (6B_ZC, 6B_VF, 6B_66, 6B_76)	85	Y22DTH	Ch: 1V500001>	10/98-09/02	DG-142		11V				4
2.2 i (6B_ZC, 6B_VF, 6B_66, 6B_76)	100	X22SE;Y22SE		10/98-07/05	K16PR-U11	3130	1.1	K16TT	IK16TT	IK16TT	4
3.2 i (6B1VF, 6B1_6)	151	6VD1;Y32NE		10/98-07/05	PK16PR-L11	3275	1.1	-	IK16TT	IK16TT	6
GT (68-73)											
1.9	66	19 S		09/68-08/73	W20FPR-U	3070	0.7	WF20TT	-	-	4
GT (07-)											
2.0	194	LNF; Z 20 NHH		06/07-	ITV20	5339	1.1	-	ITV20TT	ITV20TT	4
INSIGNIA (08-)											
1.6	85	A16XER		07/08-	KJ16CR-L11	3132	1.1	K16TT	IK16TT	IK16TT	4
1.6 Turbo	132	A16LET		07/08-	IK20L	5358	1.1	-	IK20TT	IK20TT	4
1.8	103	A 18 XER		07/08-	KJ20CR-L11	3169	1.1	K20TT	IK20TT	IK20TT	4
2.0 Biturbo CDTI 4x4	140	A 20 DTR		07/08-	DG-608		4.4V				2
2.0 CDTI	81/ 96/ 118/ 120	A 20 DT; A 20 DTC; A 20 DTH; A 20 DTJ; A 20 DTL		07/08-	DG-608		4.4V				2
2.0 CDTI 4x4	118/ 120	A 20 DTH		06/10-	DG-608		4.4V				2
2.0 E85 Turbo	162	A 20 NHT		09/10-	ITV20	5339	1.1	-	ITV20TT	ITV20TT	4
2.0 Turbo	162	A 20 NHT		07/08-	ITV20	5339	1.1	-	ITV20TT	ITV20TT	4
2.0 Turbo 4x4	162/ 184	A 20 NHT; A 20 NHT		07/08-	ITV20	5339	1.1	-	ITV20TT	ITV20TT	4
2.0 Turbo E85	162	A 20 NHT		07/08-	ITV20	5339	1.1	-	ITV20TT	ITV20TT	4
KADETT B (65-73)											
1.1	33/ 37/ 40/ 44	11 N; 11 S; 11 SR		09/65-07/71	W20FPR-U	3070	0.7	WF20TT	-	-	4
1.1 S	40	11 S		09/65-07/71	W20FPR-U	3070	0.7	WF20TT	-	-	4
1.1 SR	44	11 SR		11/66-07/71	W20FPR-U	3070	0.7	WF20TT	-	-	4
1.9	66	19 S		08/67-08/73	W20FPR-U	3070	0.7	WF20TT	-	-	4
KADETT C (73-79)											
1.2	38/40	12 N		08/73-07/79	W20FP-U	3068	0.7	WF20TT	-	-	4
1.2 S	44	12 S		08/73-07/79	W20FP-U	3068	0.7	WF20TT	-	-	4
KADETT D (79-84)											
1.0	30/33	10 N; 10 S; 10S(50)		09/79-08/82	W20FPR-U	3070	0.7	WF20TT	-	-	4
1.2	39/40	12 N; 12 ST; 12N		08/79-08/84	W20FPR-U	3070	0.7	WF20TT	-	-	4
1.2 S	44	12 S; 12S		08/79-08/84	W20FPR-U	3070	0.7	WF20TT	-	-	4
1.3 N	44	13N		08/79-08/84	W20EPR-U	3047	0.8	W20TT	IW20TT	IW20TT	4
1.3 S	55	13S		08/79-08/84	W20EPR-U	3047	0.8	W20TT	IW20TT	IW20TT	4
1.6	51/55	16 N		09/79-08/84	W20EPR-U	3047	0.8	W20TT	IW20TT	IW20TT	4
1.6 D	40	16 D		03/82-08/84	DG-001		11V				4
1.6 S	66	16 SH		09/81-08/84	W20EPR-U	3047	0.8	W20TT	IW20TT	IW20TT	4
1.8 GT/E	85	18E		02/83-08/84	W20EPR-U	3047	0.8	W20TT	IW20TT	IW20TT	4
KADETT E (84-94)											
1.2	40	12S;12ST		09/84-07/86	W20EPR-U	3047	0.8	W20TT	IW20TT	IW20TT	4

	KW				Standard			Twin Tip			QTY
											
OPEL continued											
KADETT E (84-94) continued											
1.3 i CAT	44	C13N		09/85-08/91	W20EPR-U	3047	0.8	W20TT	IW20TT	IW20TT	4
1.3 N	44	13N;13NB; 13N;C13N; 13N		09/84-08/91	W20EPR-U	3047	0.8	W20TT	IW20TT	IW20TT	4
1.3 S	55	13S		09/84-12/89	W20EPR-U	3047	0.8	W20TT	IW20TT	IW20TT	4
1.4 i	44	C14NZ		01/90-03/93	W20EPR-U	3047	0.8	W20TT	IW20TT	IW20TT	4
1.4 S	55	14NV		01/90-08/91	W20EPR-U	3047	0.8	W20TT	IW20TT	IW20TT	4
1.5 TD	53	15 DT (T4EC1)	Eng: >817252	07/88-08/91	DG-159		5V				4
1.5 TD	53	15 DT (T4EC1)	Eng: 817253>	07/88-08/91	DG-104		11V				4
1.6	60	16SV		09/86-12/91	W20EPR-U	3047	0.8	W20TT	IW20TT	IW20TT	4
1.6 D	40	16 D; 16 DA		08/84-12/89	DG-001		11V				4
1.6 i	55/60	16SV; C16LZ;E16NZ; C16NZ		07/89-03/93	W20EPR-U	3047	0.8	W20TT	IW20TT	IW20TT	4
1.6 i CAT	55	16SV; C16LZ;C16NZ; C16LZ		10/87-08/91	W20EPR-U	3047	0.8	W20TT	IW20TT	IW20TT	4
1.6 S	60/66	16S-OHC; 16SV		09/84-08/91	W20EPR-U	3047	0.8	W20TT	IW20TT	IW20TT	4
1.7 D	42/44	17 D; 17 DR		01/89-07/94	DG-001		11V				4
1.8	82/84	18 SE; 18SE		09/87-08/91	W20EPR-U	3047	0.8	W20TT	IW20TT	IW20TT	4
1.8 E	74	C18NE		10/85-08/86	W20EPR-U	3047	0.8	W20TT	IW20TT	IW20TT	4
1.8 GSI	85	18E;18SE		09/84-08/86	W20EPR-U	3047	0.8	W20TT	IW20TT	IW20TT	4
1.8 i	66/ 74/ 85	18E;18SE; C18NE; C18NZ;S18NV; C18NZ		09/84-01/91	W20EPR-U	3047	0.8	W20TT	IW20TT	IW20TT	4
1.8 i	85	18 E; 18 SE		09/84-08/86	W20PR-U	5046	0.7	-	-	-	4
1.8 S	62	18SE; E 18 NV		09/87-08/91	W20EPR-U	3047	0.8	W20TT	IW20TT	IW20TT	4
2.0 GSI	85/95	20NE; 20SEH		09/86-08/91	W20EPR-U	3047	0.8	W20TT	IW20TT	IW20TT	4
2.0 GSI 16V	110/ 115	C20XE		12/87-08/91	K20PR-U	3145	0.8	K20TT	IK20TT	IK20TT	4
2.0 GSI 16V CAT	110	C20XE		03/88-08/91	K20PR-U	3145	0.8	K20TT	IK20TT	IK20TT	4
2.0 GSI CAT	85	C20NE(115)		09/86-08/91	W20EPR-U	3047	0.8	W20TT	IW20TT	IW20TT	4
2.0 i	85	20NE		10/86-08/91	W20EPR-U	3047	0.8	W20TT	IW20TT	IW20TT	4
2.0 i CAT	85	C20NE(115)		10/86-08/91	W20EPR-U	3047	0.8	W20TT	IW20TT	IW20TT	4
MANTA A (70-75)											
1.6	55	16 S		02/75-08/75	W20EPR-U	3047	0.8	W20TT	IW20TT	IW20TT	4
1.9 S	65/66	19 S		09/70-08/75	W20FPR-U	3070	0.7	WF20TT	-	-	4
MANTA B (75-88)											
1.3 N	44	13N		03/79-12/80	W20EPR-U	3047	0.8	W20TT	IW20TT	IW20TT	4
1.3 S	55	13S		08/79-08/86	W20EPR-U	3047	0.8	W20TT	IW20TT	IW20TT	4
1.6 N	44	16N		09/75-12/80	W20EPR-U	3047	0.8	W20TT	IW20TT	IW20TT	4
1.6 S	55	16S-CVH		09/75-12/81	W20EPR-U	3047	0.8	W20TT	IW20TT	IW20TT	4
1.8 S	66	18S		07/82-07/86	W20EPR-U	3047	0.8	W20TT	IW20TT	IW20TT	4
1.9 S	66	19 S		09/75-12/80	W20FPR-U	3070	0.7	WF20TT	-	-	4
2.0 E	81	20E		08/77-08/88	W20FPR-U	3070	0.7	WF20TT	-	-	4
2.0 S	74	20S		08/77-08/84	W20FPR-U	3070	0.7	WF20TT	-	-	4
MERIVA A (03-10)											
1.3 CDTI	51/55	Y 13 DT; Z 13 DT; Z 13 DTJ		09/03-05/10	DG-171		11V				4
1.4 16V Twinport	66	Z 14 XEP		07/04-05/10	KJ16CR-L11	3132	1.1	K16TT	IK16TT	IK16TT	4
1.4 16V Twinport LPG	66	Z 14 XEP		07/04-05/10	KJ20CR-L11	3169	1.1	K20TT	IK20TT	IK20TT	4
1.6	64	Z 16 SE		05/03-05/10	K20TXR	5063	1.0	K20TT	IK20TT	IK20TT	4
1.6	77	Z16XEP(105)		01/06-05/10	KJ16CR-L11	3132	1.1	K16TT	IK16TT	IK16TT	4
1.6 16V	74	Z16XE(100)		05/03-01/06	K20TXR	5063	1.0	K20TT	IK20TT	IK20TT	4
1.6 Turbo	132	Z 16 LET		09/05-05/10	PK20PR-L11	3142	1.1	-	IK20TT	IK20TT	4
1.7 CDTI	74/92	A 17 DTR; Z 17 DT; Z 17 DTH; Z 17 DTR		09/03-05/10	DG-302		11V				4
1.7 DTI	48/55	Y 17 DTL		09/03-05/10	DG-302		11V				4
1.8	92	Z 18 XE		05/03-05/10	K20TXR	5063	1.0	K20TT	IK20TT	IK20TT	4
MERIVA B (10-)											
1.3 CDTI	55/70	A 13 DTC; A 13 DTE		06/10-	DG-621		4.4V				4
1.4	74	A 14 XER; B 14 XER		06/10-	KJ20CR-L11	3169	1.1	K20TT	IK20TT	IK20TT	4
1.7 CDTI	74/ 81/ 96	A 17 DT; A 17 DTI; A 17 DTS		06/10-	DG-302		11V				4
MOKKA (12-)											
1.6	85	A16XER		06/12-	KJ16CR-L11	3132	1.1	K16TT	IK16TT	IK16TT	4
1.8	103	A 18 XER		01/13-	KJ20CR-L11	3169	1.1	K20TT	IK20TT	IK20TT	4
1.8 4x4	103	A 18 XER		01/13-	KJ20CR-L11	3169	1.1	K20TT	IK20TT	IK20TT	4
MONTEREY A (91-98)											
3.1 TD (UBS69_)	84	4 JG2TC		09/91-07/98	DG-104		11V				4











	KW					Standard		Twin Tip		QTY	
OPEL <i>continued</i>											
MONTEREY A (91-98) <i>continued</i>											
3.2 (UBS25_)	130	6VDI		06/92-07/98	Q20PR-U	3007	0.8	Q20TT	IQ20TT	IQ20TT	6
MONTEREY B (98-99)											
3.0 DTI	117	4 JX1		07/98-08/99	DG-186		11V				4
3.5 V6 24V	158	6 VE1		07/98-08/99	PK16PR-L11	3275	1.1	-	IK16TT	IK16TT	6
MONZA A (78-86)											
2.0 E	85	20E		03/83-10/84	W20FPR-U	3070	0.7	WF20TT	-	-	4
2.2 E	85	22E		11/84-08/86	W20FPR-U	3070	0.7	WF20TT	-	-	4
2.5 E	103	25E		06/84-08/86	W20FPR-U	3070	0.7	WF20TT	-	-	6
2.8	103	28H		02/78-04/81	W20FPR-U	3070	0.7	WF20TT	-	-	6
3.0 GSE	132	30E;C30NE		06/81-08/86	W20FPR-U	3070	0.7	WF20TT	-	-	6
MOVANO A (98-)											
1.9 DTI	59/60	F9Q 770; F9Q 772; F9Q 774		09/00-	DG-005		11V				4
2.2 DTI	66	G9T 720; G9T 722; G9T 750		09/00-	DG-126		11V				4
2.5 CDTI	73/74/88/107	G9U 632; G9U 650		10/03-	DG-126		11V				4
2.5 D	59	S8U 770; S8U 772		07/98-09/00	DG-004		11.5V				4
2.5 DTi	73/84	G9U 720; G9U 724; G9U 750; G9U 754		10/01-	DG-126		11V				4
3.0 DTI	100	ZD3 200; ZD3 202		10/03-	DG-605		11V				4
OLYMPIA A (67-71)											
1.9	66	19 S		08/67-08/71	W20FPR-U	3070	0.7	WF20TT	-	-	4
OMEGA A (86-94)											
1.8	65/85	18 SEH; 18SEH; E 18 NVR		09/86-03/94	W20EPR-U	3047	0.8	W20TT	IW20TT	IW20TT	4
1.8 N	60	18 NV		09/86-08/87	W20EPR-U	3047	0.8	W20TT	IW20TT	IW20TT	4
1.8 S	66	18 SV		09/86-03/94	W20EPR-U	3047	0.8	W20TT	IW20TT	IW20TT	4
2.0	73	C 20 NEJ		09/90-03/94	K20TXR	5063	1.0	K20TT	IK20TT	IK20TT	4
2.0	74	C20NE(100)		09/90-03/94	W16EPR-U	3021	0.8	W16TT	IW16TT	IW16TT	4
2.0	90	20 SE		09/86-03/94	W20EPR-U	3047	0.8	W20TT	IW20TT	IW20TT	4
2.0 i	85	C 20 NE	Ch: R1000001, R5000001, P7000001>	09/86-03/94	K20TXR	5063	1.0	K20TT	IK20TT	IK20TT	4
2.0 i	85	C 20 NE	Ch: R5000001, R1000001, P7000001>	09/86-03/94	K20TXR	5063	1.0	K20TT	IK20TT	IK20TT	4
2.3 D	54	23 YD		09/86-03/94	DG-001		11V				4
2.3 TD	66	23 YDT		09/86-08/88	DG-001		11V				4
2.3 TD Interc.	74	23 DTR		08/88-03/94	DG-001		11V				4
2.4 i	92	C 24 NE		09/88-03/94	W20FPR-U	3070	0.7	WF20TT	-	-	4
2.6 i	110	C 26 NE		09/90-03/94	W20FPR-U	3070	0.7	WF20TT	-	-	6
3.0	115/130	30 NE; C 30 LE		03/87-03/94	W20FPR-U	3070	0.7	WF20TT	-	-	6
3.0 (3000)	115/130	30 NE; C 30 LE		03/87-09/90	W20FPR-U	3070	0.7	WF20TT	-	-	6
3.0 (3000) CAT	130	C 30 NE		03/88-03/94	W20FP-U	3068	0.7	WF20TT	-	-	6
3.0 24V	147	C 30 SEJ		09/89-03/94	K20TXR	5063	1.0	K20TT	IK20TT	IK20TT	6
3.0 24V (3000)	147/150	C 30 SEJ		09/89-03/94	K20TXR	5063	1.0	K20TT	IK20TT	IK20TT	6
3.0 CAT	130	C 30 NE		03/87-03/94	W20FP-U	3068	0.7	WF20TT	-	-	6
OMEGA B (94-03)											
2.0	85/90	20 SE; X 20 SE; XF 20 E		03/94-12/00	K20TXR	5063	1.0	K20TT	IK20TT	IK20TT	4
2.0 16V	100	X 20 XEV		03/94-09/99	K20TXR	5063	1.0	K20TT	IK20TT	IK20TT	4
2.0 DTI 16V	74	X 20 DTH		09/97-09/00	DG-118		11V				4
2.2 16V	106	Y 22 XE; Z 22 XE		09/99-07/03	K20TXR	5063	1.0	K20TT	IK20TT	IK20TT	4
2.2 DTI 16V	81/86/88	Y 22 DTH; Y 22 DTR		09/00-07/03	DG-142		11V				4
2.5 D	96	X 25 TD		05/94-05/99	DG-001		11V				6
2.5 DTI	110	Y 25 DT		09/01-07/03	DG-145		11V				6
2.5 TD	96	25 DT; X 25 DT; X 25 TD		04/94-07/03	DG-001		11V				6
2.5 V6	125	X 25 XE		03/94-09/00	K20TNR	3304	1.0	K20TT	IK20TT	IK20TT	6
2.6	138			05/94-05/99	K20TNR	3304	1.0	K20TT	IK20TT	IK20TT	6
2.6 V6	132	Y 26 SE		09/00-07/03	K20TNR	3304	1.0	K20TT	IK20TT	IK20TT	6
3.0 V6	155	X 30 XE		04/94-02/01	K20TNR	3304	1.0	K20TT	IK20TT	IK20TT	6
3.2 V6	160	Y 32 SE		02/01-07/03	K20TNR	3304	1.0	K20TT	IK20TT	IK20TT	6







	KW									QTY
OPEL continued										
REKORD B (65-67)										
1.9	66	19 S		08/65-02/67	W20FPR-U	3070	0.7	WF20TT	-	4
REKORD C (66-71)										
1.9	66	19 S		08/66-12/71	W20FPR-U	3070	0.7	WF20TT	-	4
REKORD D (72-77)										
1.7	44/49	17 N		01/72-08/77	W20FPR-U	3070	0.7	WF20TT	-	4
1.7 S	61	17 S		01/72-02/75	W20FPR-U	3070	0.7	WF20TT	-	4
1.9	55/66	19 N; 19 SH		03/75-08/77	W20FPR-U	3070	0.7	WF20TT	-	4
1.9 S	71	19 SH		01/72-02/75	W20FPR-U	3070	0.7	WF20TT	-	4
2.0	74	20 S		09/75-08/77	W20FPR-U	3070	0.7	WF20TT	-	4
2.0 S	74	20 S		09/75-08/77	W20FPR-U	3070	0.7	WF20TT	-	4
REKORD E (77-86)										
1.7	44	17N		09/77-07/81	W20FPR-U	3070	0.7	WF20TT	-	4
1.8	55	18N		11/82-07/84	W20EPR-U	3047	0.8	W20TT	IW20TT	4
1.8 E	74	C18NV		05/85-08/86	W20EPR-U	3047	0.8	W20TT	IW20TT	4
1.8 S	66	18 S		11/82-08/86	W20EPR-U	3047	0.8	W20TT	IW20TT	4
1.9	55	19 N		09/77-10/82	W20FP-U	3068	0.7	WF20TT	-	4
2.0 D	43	20 D		09/77-10/82	DG-001		11V			4
2.0 E	81	20 E; 20E		09/77-10/84	W20FPR-U	3070	0.7	WF20TT	-	4
2.0 S	74	20 S		08/77-08/86	W20FPR-U	3070	0.7	WF20TT	-	4
2.1 D	44	21 D		09/77-07/78	DG-001		11V			4
2.2 D	48/52	23 D		08/78-08/86	DG-001		11V			4
2.2 E	85	22 E		11/84-08/86	W20FPR-U	3070	0.7	WF20TT	-	4
2.2 TD	63	23 TD		06/84-08/86	DG-001		11V			4
2.3 D	52	23 D		11/82-08/86	DG-001		11V			4
SENATOR A (78-87)										
2.0 E	85	20E		03/83-10/84	W20FPR-U	3070	0.7	WF20TT	-	4
2.2 E	85	22 E		11/84-08/87	W20FPR-U	3070	0.7	WF20TT	-	4
2.2 TD	63	23 TD		11/84-02/87	DG-001		11V			4
2.5 E	103	25 E		09/84-08/87	W20FP-U	3068	0.7	WF20TT	-	6
2.8	103	28 H		02/78-04/81	W20FP-U	3068	0.7	WF20TT	-	6
3.0 E	132	30 E		02/78-12/86	W20FP-U	3068	0.7	WF20TT	-	6
SENATOR B (87-93)										
2.5 i	103	25NE		09/90-09/93	W20FPR-U	3070	0.7	WF20TT	-	6
2.6 i	110	C 26 NE		09/90-09/93	W20FPR-U	3070	0.7	WF20TT	-	6
3.0	115/ 130	30 NE; C 30 LE		09/87-09/93	W20FPR-U	3070	0.7	WF20TT	-	6
3.0 24V	150	C 30 SE		09/89-09/93	K20TXR	5063	1.0	K20TT	IK20TT	6
3.0 i CAT	130	C 30 NE		01/88-09/93	W20FP-U	3068	0.7	WF20TT	-	6
SIGNUM (03-)										
1.8	103	Z 18 XER		09/05-	KJ16CR-L11	3132	1.1	K16TT	IK16TT	4
1.8	90	Z 18 XE	Ch: >31999999	05/03-	K20TXR	5063	1.0	K20TT	IK20TT	4
1.8	90	Z 18 XE	Ch: 41000001>	05/03-	KJ16CR-L11	3132	1.1	K16TT	IK16TT	4
1.9 CDTI	110	Z 19 DTH		04/04-	DG-170		11V			4
1.9 CDTI	74/88	Z 19 DT	Ch: >71021891	04/04-	DG-122		11V			4
1.9 CDTI	74/88	Z 19 DT	Ch: 71021892>	04/04-	DG-196		11V			4
2.0 DTI	74	Y 20 DTH		05/03-	DG-142		11V			4
2.0 Turbo	129	Z20NET(MY6A)		05/03-11/08	PK20PR-L11	3142	1.1	-	IK20TT	4
2.2 direct	114	Z22YH(P2CA);Z22YH(P35A)		05/03-11/08	K20PBR	5060	0.85	K20TT	IK20TT	4
2.2 DTI	92	Y 22 DTR		05/03-	DG-142		11V			4
2.8	206	Z 28 NET		10/06-08/08	IKH20	5344	1.1	-	IKH20TT	6
2.8 V6 Turbo	169/ 184	Z 28 NEL; Z 28 NET		09/05-08/08	IKH20	5344	1.1	-	IKH20TT	6
3.0 V6 CDTI	130/ 135	Y 30 DT; Z 30 DT		05/03-12/08	DG-312		11V			6
3.2 V6	155	Z32SE(211)		05/03-09/05	K20TXR	5063	1.0	K20TT	IK20TT	6
SINTRA (96-99)										
2.2 DTI	85	X 22 DTH		07/97-04/99	DG-118		11V			4
2.2 i 16V	104	X 22 XE		11/96-04/99	K20TXR	5063	1.0	K20TT	IK20TT	4
3.0 i 24V	148	X 30 XE		11/96-04/99	K20TXR	5063	1.0	K20TT	IK20TT	6
SPEEDSTER (00-)										
2.0	162	Z 20 LET		10/03-08/06	K20TXR	5063	1.0	K20TT	IK20TT	4
2.0 Turbo	147	Z 20 LET		04/03-	K20TXR	5063	1.0	K20TT	IK20TT	4
2.2	108	Z 22 SE		09/00-	PT16VR13	5068	1.3	TV16TT	ITV16TT	4
TIGRA (94-00)										
1.4 16V	63/66	X 14 XE		07/94-12/00	K20TXR	5063	1.0	K20TT	IK20TT	4

	KW								QTY		
OPEL <i>continued</i>											
TIGRA (94-00) <i>continued</i>											
1.6 16V	74/78	C 16 SEL; X 16 XE		07/94-08/98	K20TXR	5063	1.0	K20TT	IK20TT	IK20TT	4
TIGRA TwinTop (04-)											
1.3 CDTI	51	Z 13 DT		06/04-	DG-171		11V				4
1.4	66	Z 14 XEP		06/04-	KJ16CR-L11	3132	1.1	K16TT	IK16TT	IK16TT	4
1.8	92	Z 18 XE		06/04-08/09	KJ16CR-L11	3132	1.1	K16TT	IK16TT	IK16TT	4
VECTRA A (88-95)											
1.4 S	55	14 NV	Eng: >02BF1476	04/88-06/92	W20EPR-U	3047	0.8	W20TT	IW20TT	IW20TT	4
1.6	60	16 SV		09/88-05/93	W20EPR-U	3047	0.8	W20TT	IW20TT	IW20TT	4
1.6 i	52/55	16 LZ2; X 16 SZ		09/93-11/95	K20TXR	5063	1.0	K20TT	IK20TT	IK20TT	4
1.6 i	55	C 16 NZ; C 16 NZ2; E 16 NZ	Check Hex size	09/93-11/95	K20TXR	5063	1.0	K20TT	IK20TT	IK20TT	4
1.6 i	55	C 16 NZ; C 16 NZ2; E 16 NZ	Check Hex size	09/88-08/93	W16EPR-U	3021	0.8	W16TT	IW16TT	IW16TT	4
1.6 i CAT	55	C 16 NZ; C 16 NZ2	Check Hex size	09/93-11/95	K20TXR	5063	1.0	K20TT	IK20TT	IK20TT	4
1.6 i CAT	55	C 16 NZ; C 16 NZ2	Check Hex size	09/88-08/93	W16EPR-U	3021	0.8	W16TT	IW16TT	IW16TT	4
1.6 S	60	16 SV		09/88-05/93	W20EPR-U	3047	0.8	W20TT	IW20TT	IW20TT	4
1.7 D	42/44	17 D; 17 DR		09/88-11/95	DG-001		11V				4
1.7 TD	60	17 DT (TC4EE1)	Eng: >731417	03/90-11/95	DG-124		11V				4
1.7 TD	60	17 DT (TC4EE1)	Eng: 731418>	03/90-11/95	DG-300		11V				4
1.8 i	66	18 SV		09/88-10/90	W20EPR-U	3047	0.8	W20TT	IW20TT	IW20TT	4
1.8 i CAT	66	C 18 NZ		03/90-11/95	W16EPR-U	3021	0.8	W16TT	IW16TT	IW16TT	4
1.8 S	65/66	18 SV; E 18 NVR		09/88-10/90	W20EPR-U	3047	0.8	W20TT	IW20TT	IW20TT	4
1.8 S 4x4	65	E 18 NVR		01/89-07/89	W20EPR-U	3047	0.8	W20TT	IW20TT	IW20TT	4
2.0	74	C 20 NEF		09/88-09/89	IW16	5305	1.1	-	IW16TT	IW16TT	4
2.0	74	C20NE(100)		04/88-09/89	W16EPR-U	3021	0.8	W16TT	IW16TT	IW16TT	4
2.0 i	95	20 SEH		09/88-09/92	W20EPR-U	3047	0.8	W20TT	IW20TT	IW20TT	4
2.0 i	85	20 NE	Ch: P7000001, R1000001, R5000001>	09/88-10/90	K20TXR	5063	1.0	K20TT	IK20TT	IK20TT	4
2.0 i 16V	100	X 20 XEV		06/94-11/95	K20TXR	5063	1.0	K20TT	IK20TT	IK20TT	4
2.0 i 16V 4x4	100	X 20 XEV		06/94-11/95	K20TXR	5063	1.0	K20TT	IK20TT	IK20TT	4
2.0 i 16V CAT	110	C 20 XE	Eng: 14002935;1410 43 55>	02/90-11/95	K20TXR	5063	1.0	K20TT	IK20TT	IK20TT	4
2.0 i 4x4	95	20 SEH		01/89-09/92	W20EPR-U	3047	0.8	W20TT	IW20TT	IW20TT	4
2.0 i 4x4	85	20 NE	Ch: P7000001, R1000001, R5000001>	01/89-10/90	K20TXR	5063	1.0	K20TT	IK20TT	IK20TT	4
2.0 i 4x4 CAT	85	C 20 NE	Ch: P7000001, R1000001, R5000001>	01/89-11/95	K20TXR	5063	1.0	K20TT	IK20TT	IK20TT	4
2.0 i CAT	85	C 20 NE	Ch: R1000001, R5000001, P7000001>	09/88-11/95	K20TXR	5063	1.0	K20TT	IK20TT	IK20TT	4
2.0 i CAT	85	C 20 NE	Ch: R5000001, R1000001, P7000001>	09/88-11/95	K20TXR	5063	1.0	K20TT	IK20TT	IK20TT	4
2.0 i GT	95	20 SEH		09/88-11/95	W20EPR-U	3047	0.8	W20TT	IW20TT	IW20TT	4
2.0 i Turbo 4x4	150	C 20 LET		06/94-11/95	K20R-U	3122	0.8	K20TT	IK20TT	IK20TT	4
2.5 V6	125	C 25 XE		02/93-11/95	K20TXR	5063	1.0	K20TT	IK20TT	IK20TT	6
2000 16V 4x4	110	20 XEJ		01/89-10/90	Q20PR-U	3007	0.8	Q20TT	IQ20TT	IQ20TT	4
2000/GT 16V	110	20 XEJ		01/89-06/94	Q20PR-U	3007	0.8	Q20TT	IQ20TT	IQ20TT	4
2000/GT 16V 4x4 CAT	110	C 20 XE	Eng: 14104355;1400 29 35>	02/90-11/95	K20TXR	5063	1.0	K20TT	IK20TT	IK20TT	4
2000/GT 16V CAT	110	C 20 XE	Eng: 14002935;1410 43 55>	02/90-11/95	K20TXR	5063	1.0	K20TT	IK20TT	IK20TT	4
VECTRA B (95-03)											
1.6 GL	60	16 SV		09/95-08/96	K20TXR	5063	1.0	K20TT	IK20TT	IK20TT	4
1.6 i	55	16 LZ2; X 16 SZR		10/95-04/02	K20TXR	5063	1.0	K20TT	IK20TT	IK20TT	4
1.6 i 16V	74	X 16 XEL; Y 16 XE; Z 16 XE		10/95-07/02	K20TXR	5063	1.0	K20TT	IK20TT	IK20TT	4
1.7 TD	60	X 17 DT (TC4EE1)		10/95-12/98	DG-300		11V				4
1.8 i 16V	85/92	X 18 XE; X 18 XE1; Z 18 XEL		10/95-07/03	K20TXR	5063	1.0	K20TT	IK20TT	IK20TT	4

Spark & Glow Plugs



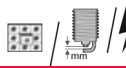





Application Tables







	KW										QTY
OPEL continued											
VECTRA B (95-03) continued											
2.0 DI 16V	60	X 20 DTL	Ch: > V1;V5;V7;VL;V P: VS	11/96-04/02	DG-133		11V				4
2.0 DI 16V	60	X 20 DTL	Ch: W1;W5;W7;XL; WP; WS>	11/96-04/02	DG-118		11V				4
2.0 DTI 16V	74	Y 20 DTH		06/97-07/03	DG-142		11V				4
2.0 DTI 16V	74	X 20 DTH	Ch: W1;W5;W7;XL; WP; WS>	06/97-07/03	DG-118		11V				4
2.0 i	82	20 NEJ		10/95-02/02	K20TXR	5063	1.0	K20TT	IK20TT	IK20TT	4
2.0 i 16V	100	C 20 SEL; X 20 XEV		10/95-09/00	K20TXR	5063	1.0	K20TT	IK20TT	IK20TT	4
2.2 DTI 16V	88/92	Y 22 DTR		09/00-07/03	DG-142		11V				4
2.2 i 16V	108	Z 22 SE		09/00-07/03	PT16VR13	5068	1.3	TV16TT	ITV16TT	ITV16TT	4
2.5	144	X 25 XE		10/99-06/00	K20TXR	5063	1.0	K20TT	IK20TT	IK20TT	6
2.5 i V6	125	X 25 XE		10/95-09/00	K20TXR	5063	1.0	K20TT	IK20TT	IK20TT	6
2.6 i V6	125	Y 26 SE		09/00-07/03	K20TXR	5063	1.0	K20TT	IK20TT	IK20TT	6
i 500 2.5	143	X 25 XE		05/98-09/00	K20TXR	5063	1.0	K20TT	IK20TT	IK20TT	6
VECTRA C (02-)											
1.6	74/77	Z16XE(100); Z16XEP(105)		08/05-02/09	KJ16CR-L11	3132	1.1	K16TT	IK16TT	IK16TT	4
1.6	77	Z16XEP(105)	Ch: > 31999999, 38999999	01/06-	K20TXR	5063	1.0	K20TT	IK20TT	IK20TT	4
1.6 16V	74	Z16XE(100)		06/04-09/05	K20TXR	5063	1.0	K20TT	IK20TT	IK20TT	4
1.6 16V	74	Z16XE(100)		10/05-02/09	KJ16CR-L11	3132	1.1	K16TT	IK16TT	IK16TT	4
1.6 16V	74	Z16XEP(105)	Ch: > 31999999, 38999999	06/04-	K20TXR	5063	1.0	K20TT	IK20TT	IK20TT	4
1.6 16V	74	Z16XEP(105)	Ch: 41000001, 48000001>	06/04-09/05	KJ16CR-L11	3132	1.1	K16TT	IK16TT	IK16TT	4
1.8	81/ 90/ 103	Z18XE(122); Z18XEL(110); Z18XER(140)		10/03-02/09	KJ16CR-L11	3132	1.1	K16TT	IK16TT	IK16TT	4
1.8	81	Z18XEL(110)	Flexible fuel	04/02-09/05	K20TXR	5063	1.0	K20TT	IK20TT	IK20TT	4
1.8 16V	90	Z18XEL(110). Z18GPL		08/02-09/05	K20TXR	5063	1.0	K20TT	IK20TT	IK20TT	4
1.8 16V	90	Z18XE(122);Z18XE(1 25); Z18XE(122)		04/02-02/09	KJ16CR-L11	3132	1.1	K16TT	IK16TT	IK16TT	4
1.8 16V	90	Z18GPL	Flexible fuel	04/02-01/03	K20TXR	5063	1.0	K20TT	IK20TT	IK20TT	4
1.9 CDTI	110	Z 19 DTH		04/04-	DG-170		11V				4
1.9 CDTI	74/88	Z 19 DT; Z 19 DTL	Ch: > 71021891; 48999999	04/04-	DG-122		11V				4
1.9 CDTI	74/88	Z 19 DT; Z 19 DTL	Ch: 71021892; 78>	04/04-	DG-196		11V				4
2.0 16V Turbo	129	Z20NET(MY6A)		03/03-02/09	PK20PR-L11	3142	1.1	-	IK20TT	IK20TT	4
2.0 DTI	74	Y 20 DTH		10/03-	DG-142		11V				4
2.0 DTI 16V	74	Y 20 DTH		04/02-	DG-142		11V				4
2.0 Turbo	129	Z20NET(MY6A)		10/03-02/09	PK20PR-L11	3142	1.1	-	IK20TT	IK20TT	4
2.2 16V	108	Z 22 SE		04/02-	PT16VR13	5068	1.3	TV16TT	ITV16TT	ITV16TT	4
2.2 direct	114	Z22YH(P2CA)		10/03-02/09	K20PBR	5060	0.85	K20TT	IK20TT	IK20TT	4
2.2 DTI	92	Y 22 DTR		10/03-	DG-142		11V				4
2.2 DTI 16V	92	Y 22 DTR		04/02-	DG-142		11V				4
2.8 V6 Turbo	169/ 184/ 188/ 206	Z 28 NEL; Z 28 NET		08/05-08/08	IKH20	5344	1.1	-	IKH20TT	IKH20TT	6
2.8 V6 Turbo OPC	206	Z 28 NET		09/06-09/08	IKH20	5344	1.1	-	IKH20TT	IKH20TT	6
3.0 CDTI	130/ 135	Y 30 DT; Z 30 DT		06/03-	DG-312		11V				6
3.0 V6 CDTI	130/ 135	Y 30 DT; Z 30 DT		10/03-	DG-312		11V				6
3.2 V6	155	Z32SE(210)		08/02-09/05	K20TXR	5063	1.0	K20TT	IK20TT	IK20TT	6
VIVARO A (01-)											
1.9 DI	60	F9Q 762; F9Q 774		08/01-	DG-005		11V				4
1.9 DTI	74	F9Q 760		08/01-	DG-005		11V				4
2.0 16V	88	F4R 720; F4R.7.20		08/01-	PK20PR-P8	3245	0.8	-	IK20TT	IK20TT	4
2.0 ECOTEC	86	F4R 820		08/06-	K20TXR	5063	1.0	K20TT	IK20TT	IK20TT	4

	KW								QTY		
OPEL <i>continued</i>											
VIVARO A (01-) <i>continued</i>											
2.0 ECOTEC	86	F4R 820		08/06-	PK20PR-P8	3245	0.8	-	IK20TT	IK20TT	4
2.5 CDTI	84/107	G9U 630		08/06-	DG-126		11V				4
2.5 DTI	99	G9U 730		05/03-	DG-126		11V				4
ZAFIRA A (99-05)											
1.6 16V	74	Z 16 XE		04/99-06/05	K20TXR	5063	1.0	K20TT	IK20TT	IK20TT	4
1.6 16V	74	X16XEL		04/99-06/05	KJ20CR-L11	3169	1.1	K20TT	IK20TT	IK20TT	4
1.6 CNG	71	Z16YNG(96)	Flexible fuel	09/01-06/05	PK20PR-P8	3245	0.8	-	IK20TT	IK20TT	4
1.8 16V	85/92	X 18 XE1; Z 18 XE		04/99-06/05	K20TXR	5063	1.0	K20TT	IK20TT	IK20TT	4
2.0 DI 16V	60	X 20 DTL		10/99-06/05	DG-118		11V				4
2.0 DTI 16V	74	Y 20 DTH	Ch: >22999999; 25999999; 26999999; 28999999; 2B999999; 2H999999; 2G	09/00-06/05	DG-118		11V				4
2.0 DTI 16V	74	Y 20 DTH	Ch: 32000001; 35000001; 36000001; 38000001; 3B000001; 3H000001; 4G000001>	09/00-06/05	DG-142		11V				4
2.0 OPC	141/147	Z 20 LET		09/01-06/05	K20TXR	5063	1.0	K20TT	IK20TT	IK20TT	4
2.0 OPC	147	Z 20 LER		11/02-06/05	KJ16CR-L11	3132	1.1	K16TT	IK16TT	IK16TT	4
2.2 16V	108	Z 22 SE		09/00-06/05	PT16VR13	5068	1.3	TV16TT	ITV16TT	ITV16TT	4
2.2 DTI 16V	86/92	Y 22 DTR		01/02-06/05	DG-142		11V				4
ZAFIRA B (05-)											
1.6	77	Z16XEP(105)		07/05-07/08	KJ16CR-L11	3132	1.1	K16TT	IK16TT	IK16TT	4
1.6	85	A 16 XER; Z 16 XER	Ch: > 92999999; 9G999999	01/08-	KJ16CR-L11	3132	1.1	K16TT	IK16TT	IK16TT	4
1.6	85	A 16 XER; Z 16 XER	Ch: A2000001; AG000001>	01/08-	KJ20CR-L11	3169	1.1	K20TT	IK20TT	IK20TT	4
1.6 CNG	69	Z16YNG(94)	Flexible fuel	07/08-	PK20PR-P8	3245	0.8	-	IK20TT	IK20TT	4
1.7 CDTI	81/92	A 17 DTJ; A 17 DTR; Z 17 DTJ		01/08-	DG-302		11V				4
1.8	103	A 18 XER; Z 18 XER	Ch: > D2999999; AG999999	07/05-	KJ16CR-L11	3132	1.1	K16TT	IK16TT	IK16TT	4
1.8	103	A 18 XER; Z 18 XER	Ch: E2000001>	07/05-	KJ20CR-L11	3169	1.1	K20TT	IK20TT	IK20TT	4
1.9 CDTI	110	Z 19 DTH		07/05-	DG-170		11V				4
1.9 CDTI	74/88	Z 19 DTL	Ch: > 62999999;6G9 999 9	07/05-	DG-122		11V				4
1.9 CDTI	74/88	Z 19 DTL	Ch: 72000001;7G0 000 1>	07/05-	DG-196		11V				4
2.0	125/147	Z 20 LEL; Z 20 LER		07/05-	KJ16CR-L11	3132	1.1	K16TT	IK16TT	IK16TT	4
2.0	177	Z 20 LEH		01/06-	PK20PR-P8	3245	0.8	-	IK20TT	IK20TT	4
2.2	110	Z22YH(150)		07/08-	K20PBR	5060	0.85	K20TT	IK20TT	IK20TT	4
2.2	110	Z22YH(P35A)		07/05-07/08	KJ16CR-L11	3132	1.1	K16TT	IK16TT	IK16TT	4
ZAFIRA C (11-)											
1.8	85/88	A 18 XEL		10/11-	KJ16CR-L11	3132	1.1	K16TT	IK16TT	IK16TT	4
1.8	103	A 18 XER		10/11-	KJ20CR-L11	3169	1.1	K20TT	IK20TT	IK20TT	4
1.8 LPG	101	A 18 XER		10/11-	VK20	5604	1.1	-	IK20TT	IK20TT	4
2.0 CDTi	118/121	A 20 DTH		01/12-	DG-608		4.4V				3
PANTHER											
KALLISTA (82-93)											
1.6	71			01/82-12/92	K20PR-U	3145	0.8	K20TT	IK20TT	IK20TT	4
PERODUA											
ALZA (09-)											
1.5	76	3SZ-VE		03/09-	SXU22PR9	3434	0.9	-	-	VXU22I	4
KENARI (00-)											
1.0	41	EJ-DE		10/00-	K16TNR-S9	3329	0.9	K16TT	IK16TT	IK16TT	3

Spark & Glow Plugs

Application Tables







PERODUA <i>continued</i>	KW				Standard			Twin Tip			QTY
											
PERODUA <i>continued</i>											
MYVI (06-11)											
1.3	63	K3-VE		01/06-06/11	K20R-U11	3139	1.1	K20TT	IK20TT	IK20TT	4
PEUGEOT											
104 (72-88)											
0.9	33/34	108 (XV3); 108 (XV5)		07/74-10/83	T20EPR-U	5032	0.8	T20TT	IT20TT	IT20TT	4
1.0	32	108C (XV8)		09/83-06/88	T20EPR-U	5032	0.8	T20TT	IT20TT	IT20TT	4
1.1	49	121 (XW3S)		08/75-06/80	T20EPR-U	5032	0.8	T20TT	IT20TT	IT20TT	4
1.1	37/42	109 (XW3); 109F (XW7)		08/79-06/88	T20EP-U	5031	0.8	T20TT	IT20TT	IT20TT	4
1.1	48	XW3S		09/73-09/79	T22EP-U	5040	0.8	-	-	-	4
1.2	42	129 (XZ5)		08/79-06/83	T20EP-U	5031	0.8	T20TT	IT20TT	IT20TT	4
1.4	53	150 (XY6B)		08/79-06/84	T20EP-U	5031	0.8	T20TT	IT20TT	IT20TT	4
106 I (91-96)											
1.0	33/37	CDY (TU9M); CDZ (TU9M); TU9		09/91-04/96	Q16PR-U	3137	0.8	Q16TT	IQ16TT	IQ16TT	4
1.1	44	HDZ (TU1M)		07/95-04/96	K20TXR	5063	1.0	K20TT	IK20TT	IK20TT	4
1.3	72	TU2J2		10/93-04/96	K22PBR-S	5062	0.85	-	-	VK22	4
1.4	69	KFZ (TU3J2/Z)		09/91-04/96	IK22	5310	0.8	-	-	VK22	4
1.4	51	K5A (TU3)		08/91-03/96	K20PR-U	3145	0.8	K20TT	IK20TT	IK20TT	4
1.4	55	KDY (TU3M)		03/95-04/96	K20TXR	5063	1.0	K20TT	IK20TT	IK20TT	4
1.4 D	37	K9Y (TUD3Y)		09/92-04/96	DG-004		11.5V				4
1.5 D	40/43	VJY (TUD5)		06/94-04/96	DG-003		11V				4
1.6	65	NFZ (TU5JP)		06/93-04/96	K16PR-U	3191	0.8	K16TT	IK16TT	IK16TT	4
1.6	76	NFY (TU5J2)		01/94-04/96	K20TNR-S	3196	1.0	K20TT	IK20TT	IK20TT	4
106 II (96-)											
1.0 i	33/37	CDY (TU9M); CDZ (TU9M)		05/96-	K20TXR	5063	1.0	K20TT	IK20TT	IK20TT	4
1.1 i	40/44	HDY (TU1M); HDZ (TU1M); HFX (TU1JP)		05/96-	K20TXR	5063	1.0	K20TT	IK20TT	IK20TT	4
1.4 i	55	KFX (TU3JP)		05/96-07/04	K20TXR	5063	1.0	K20TT	IK20TT	IK20TT	4
1.5 D	40/42	VJX (TUD5); VJY (TUD5)		05/96-	DG-003		11V				4
1.6 i	65	NFZ (TU5JP)		05/96-	K16PR-U	3191	0.8	K16TT	IK16TT	IK16TT	4
1.6 i	74	NFW (TU5J2); NFY (TU5J2)		05/96-	K20TNR-S	3196	1.0	K20TT	IK20TT	IK20TT	4
1.6 S16	87	NFX (TU5J4)		05/96-	K16PR-U	3191	0.8	K16TT	IK16TT	IK16TT	4
107 (05-)											
1.0	50	1KR (384 F)		06/05-	K16HR-U11	3482	1.1	KH16TT	IKH16TT	IKH16TT	3
1.4 HDi	40	8HT (DV4TD)		06/05-	DG-113		11V				4
108 (14-)											
1.0	51	1KR-FE		07/14-	SC16HR11	3499	1.1	-	IXEH20TT	IXEH20TT	3
1.0 VTi	51	1KR-FE		07/14-	SC16HR11	3499	1.1	-	IXEH20TT	IXEH20TT	3
205 I (83-94)											
1.0	33	108C (XV8)		02/83-10/87	T20EP-U	5031	0.8	T20TT	IT20TT	IT20TT	4
1.1	36/37	109F (XW7); 109N (XW7)		02/83-10/87	T20EP-U	5031	0.8	T20TT	IT20TT	IT20TT	4
1.1 CJ	44	HDZ (TU1M)		10/89-12/94	Q16PR-U	3137	0.8	Q16TT	IQ16TT	IQ16TT	4
1.3	47	G1A		02/84-10/87	Q20P-U	3125	0.8	Q20TT	IQ20TT	IQ20TT	4
1.4	62	K2B (TU3S)		08/87-07/88	K20PR-U	3145	0.8	K20TT	IK20TT	IK20TT	4
1.4	44	150D (XY7); 150G (XY7)		02/83-10/87	T20EP-U	5031	0.8	T20TT	IT20TT	IT20TT	4
1.4	53/58	150 (XY6B); 150H (XY8)		02/83-10/87	T22EP-U	5040	0.8	-	-	-	4
1.4 CJ	55	KDY (TU3M)		07/92-12/94	Q16PR-U	3137	0.8	Q16TT	IQ16TT	IQ16TT	4
1.4 CJ	49	K1D (TU3A)		03/89-12/94	Q20PR-U	3007	0.8	Q20TT	IQ20TT	IQ20TT	4
1.4 CJ	44	150D (XY7); 150G (XY7)		03/88-05/89	T20EP-U	5031	0.8	T20TT	IT20TT	IT20TT	4
1.4 CJ CAT	44	KAY (TU3CP)		01/89-09/93	Q16P-U11	3254	1.1	Q16TT	IQ16TT	IQ16TT	4
1.4 CT	58	150B (XY8); 150H (XY8)		04/86-07/87	T22EP-U	5040	0.8	-	-	-	4
1.5	63	Y2/K		02/84-10/87	K20PR-U	3145	0.8	K20TT	IK20TT	IK20TT	4
1.6	85			08/87-07/92	K20PR-U	3145	0.8	K20TT	IK20TT	IK20TT	4
1.6	53	B1E (XU51C)		03/87-10/87	Q20P-U	3125	0.8	Q20TT	IQ20TT	IQ20TT	4
1.6	55	B1A (XU51C)		08/86-10/87	T20EP-U	5031	0.8	T20TT	IT20TT	IT20TT	4
1.6	55	BAZ (XU5CP)		08/86-10/87	T22EP-U	5040	0.8	-	-	-	4
1.6 CJ	65	BDY (XU5M3Z)		08/92-12/94	Q16PR-U	3137	0.8	Q16TT	IQ16TT	IQ16TT	4
1.6 CTI	76	180Z (XU5J)		04/86-07/87	T22EP-U	5040	0.8	-	-	-	4
1.6 GTI	76	180A (XU5J)		12/84-10/87	T22EP-U	5040	0.8	-	-	-	4
1.7 Diesel	44	161A (XUD7)		08/83-10/87	DG-001		11V				4
1.8 Rally	147			07/84-02/86	T20EPR-U	5032	0.8	T20TT	IT20TT	IT20TT	4





	KW					Standard			Twin Tip				QTY	
PEUGEOT <i>continued</i>														
205 I (83-94) <i>continued</i>														
1.9 CTi	74/92	DFZ (XU9J1)		08/87-07/92	K20PR-U	3145	0.8	K20TT	IK20TT	IK20TT				4
1.9 CTI	75	DFZ (XU9J1)		11/89-12/94	Q16PR-U	3137	0.8	Q16TT	IQ16TT	IQ16TT				4
1.9 GTI	94	D6B (XU9JA)		10/86-10/87	IK22	5310	0.8	-	-	-			VK22	4
205 II (87-98)														
1.0	33	TU9		10/87-09/98	Q20P-U	3125	0.8	Q20TT	IQ20TT	IQ20TT				4
1.1	44	HDZ (TU1M)		07/89-05/97	IK16	5303	1.1	-	-	IK16TT	IK16TT			4
1.1	36	109N (XW7)		10/87-10/90	Q16P-U11	3254	1.1	Q16TT	IQ16TT	IQ16TT				4
1.1	40	H1B (TU1)		10/87-10/90	Q20PR-U	3007	0.8	Q20TT	IQ20TT	IQ20TT				4
1.1 XA	40	E1		07/87-10/88	Q20PR-U	3007	0.8	Q20TT	IQ20TT	IQ20TT				4
1.2	47	F1		01/87-12/90	Q20P-U	3125	0.8	Q20TT	IQ20TT	IQ20TT				4
1.3	47	G1A		08/90-07/92	Q20P-U	3125	0.8	Q20TT	IQ20TT	IQ20TT				4
1.3 Rallye	74	TU24		10/87-10/90	K22PBR-S	5062	0.85	-	-	-			VK22	4
1.4	55/ 58/ 62	150B (XY8); 150H (XY8); K2B (TU3S); KFX (TU3JP)		06/87-05/97	IK20	5304	1.1	-	-	IK20TT	IK20TT			4
1.4	63	Y2/K		06/87-07/87	K20PR-U	3145	0.8	K20TT	IK20TT	IK20TT				4
1.4	55	TU32		08/90-05/97	K20TXR	5063	1.0	K20TT	IK20TT	IK20TT				4
1.4	49	K1D (TU3A)		10/87-10/90	Q16P-U11	3254	1.1	Q16TT	IQ16TT	IQ16TT				4
1.4	53	150 (XY6B)		01/87-07/88	T20EPR-U	5032	0.8	T20TT	IT20TT	IT20TT				4
1.4	44	150D (XY7); 150G (XY7)		10/87-05/89	T20EP-U	5031	0.8	T20TT	IT20TT	IT20TT				4
1.4 CAT	44	KAY (TU3CP)		08/87-07/90	Q20PR-U	3007	0.8	Q20TT	IQ20TT	IQ20TT				4
1.6	66	171 (XU5S)		08/90-07/92	Q20PR-U	3007	0.8	Q20TT	IQ20TT	IQ20TT				4
1.6	55	BAZ (XU5CP)		10/87-09/98	Q20P-U	3125	0.8	Q20TT	IQ20TT	IQ20TT				4
1.6	53	B1E (XU51C)		10/87-09/98	T22EP-U	5040	0.8	-	-	-				4
1.6 Aut.	65	BDY (XU5M2Z)		05/90-09/98	Q20PR-U	3007	0.8	Q20TT	IQ20TT	IQ20TT				4
1.6 Aut.	58			10/87-12/90	Q20P-U	3125	0.8	Q20TT	IQ20TT	IQ20TT				4
1.6 GTI	85			10/87-12/89	Q20PR-U	3007	0.8	Q20TT	IQ20TT	IQ20TT				4
1.6 GTI	76	180Z (XU5J)		10/87-12/89	Q22P-U	3255	0.8	-	-	-			VQ22	4
1.6 GTX	69	J2		01/87-10/91	K20PR-U	3145	0.8	K20TT	IK20TT	IK20TT				4
1.7 Diesel	44	161A (XUD7)		07/87-	DG-001		11V							4
1.8 TD	57	A8B (XUD7TE)		01/94-09/98	DG-001		11V							4
1.8 XDT	58	XUD7T		08/90-05/97	DG-001		11V							4
1.9 Diesel	47	DJZ (XUD9Y)		10/87-09/98	DG-001		11V							4
1.9 GTI	88	DKZ (XU9JAZ)		10/87-07/90	IK20	5304	1.1	-	-	IK20TT	IK20TT			4
1.9 GTI	94	D6B (XU9JA)		10/87-12/92	Q20P-U	3125	0.8	Q20TT	IQ20TT	IQ20TT				4
206 (98-)														
1.1	40/44	HFX (TU1JP)		08/98-	K20PR-U	3145	0.8	K20TT	IK20TT	IK20TT				4
1.1 i	44	HFX (TU1JP); HFZ (TU1JP)		09/98-	K20PR-U	3145	0.8	K20TT	IK20TT	IK20TT				4
1.4	55	KFV (TU3A); KFW (TU3JP)		07/02-	K20PR-U	3145	0.8	K20TT	IK20TT	IK20TT				4
1.4 16V	65	KFU (ET3J4)		10/03-02/07	XE20HR-U9	3427	0.9	-	-	IXEH20TT	IXEH20TT			4
1.4 HDi	50	8HX (DV4TD)		09/01-	DG-113		11V							4
1.4 HDi	50	8HZ (DV4TD)		10/05-03/09	DG-180		11V							4
1.4 HDi	51	8HX (DV4TD)	Ch: >10220	09/02-11/04	DG-113		11V							4
1.4 HDi	51	8HX (DV4TD)	Ch: 10221>	12/04-02/07	DG-180		11V							4
1.4 HDi eco 70	50	8HX (DV4TD); 8HZ (DV4TD)		09/01-	DG-113		11V							4
1.4 HDi eco 70	50	8HZ (DV4TD)		09/08-	DG-180		11V							4
1.4 i	55	KFW (TU3JP); KFX (TU3JP)		09/98-	K20PR-U	3145	0.8	K20TT	IK20TT	IK20TT				4
1.4 LPG	55	KFV (TU3JP)		05/06-09/07	K20PR-U	3145	0.8	K20TT	IK20TT	IK20TT				4
1.6	81			05/05-07/08	K16HPR-U11	6076	1.1	KH16TT	IKH16TT	IKH16TT				4
1.6 16V	80	NFU (TU5JP4)		12/00-	K16HPR-U11	6076	1.1	KH16TT	IKH16TT	IKH16TT				4
1.6 HDi 110	80	9HY (DV6TED4); 9HZ (DV6TED4)		05/04-	DG-113		11V							4
1.6 i	65	NFZ (TU5JP)		09/98-12/00	K16PR-U	3191	0.8	K16TT	IK16TT	IK16TT				4
1.9 D	51	WJZ (DW8)		09/98-05/07	DG-003		11V							4
2.0 16V	100	RFN (EW10J4)		07/02-02/07	K16HPR-U11	6076	1.1	KH16TT	IKH16TT	IKH16TT				4
2.0 HDi	66	RHY (DW10TD)		07/02-	DG-116		11V							4
2.0 HDi 90	66	RHY (DW10TD)		12/99-	DG-116		11V							4
2.0 RC	130	RFK (EW10J4S)		07/03-	K20HR-U11	3381	1.1	KH20TT	IKH20TT	IKH20TT				4
2.0 S16	99/ 100	RFN (EW10J4); RFR (DEW10J4)		04/99-02/07	K16HPR-U11	6076	1.1	KH16TT	IKH16TT	IKH16TT				4
206 CC (00-)														
1.6 16V	80	NFU (TU5JP4)		09/00-	K16HPR-U11	6076	1.1	KH16TT	IKH16TT	IKH16TT				4
1.6 HDi 110	80	9HZ (DV6TED4)		04/05-	DG-113		11V							4

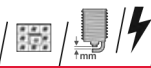





Spark & Glow Plugs









Application Tables











KW	KW	KW	KW	KW	Standard			Twin Tip			QTY
					Standard	Standard	Standard	Twin Tip	Twin Tip	Twin Tip	
PEUGEOT <i>continued</i>											
206 CC (00-) <i>continued</i>											
2.0 S16	100	RFN (EW10J4)		09/00-02/07	K16HPR-U11	6076	1.1	KH16TT	IKH16TT	IKH16TT	4
206+ (09-)											
1.1	44	HFX (TU1A); HFX (TU1JP); TU1AE5		01/09-	K20PR-U	3145	0.8	K20TT	IK20TT	IK20TT	4
1.4 HDi eco 70	50	8HX (DV4TD); 8HZ (DV4TD)		01/09-	DG-180		11V				4
1.4 i	54/55	KFT (TU3A); KFV (TU3A); KFW (TU3A)		01/09-	K20PR-U	3145	0.8	K20TT	IK20TT	IK20TT	4
1.6 16V	80	NFU (TU5JP4)		07/10-	K16HPR-U11	6076	1.1	KH16TT	IKH16TT	IKH16TT	4
207 (06-)											
1.4	53/54/55	KFV (TU3A); KFW (TU3A)		02/06-	K20PR-U	3145	0.8	K20TT	IK20TT	IK20TT	4
1.4 16V	70	8FS (EP3); EP3; EP3C		06/07-	VXUH22	5611	0.9	-	-	VXUH22	4
1.4 16V	65	KFU (ET3J4)		02/06-	XE20HR-U9	3427	0.9	-	IXEH20TT	IXEH20TT	4
1.4 Bioflex	60	KFW (TU3A)		11/08-	K20PR-U	3145	0.8	K20TT	IK20TT	IK20TT	4
1.4 HDi	50	8HR (DV4C); 8HZ (DV4TD)		02/06-	DG-180		11V				4
1.6	81	N6A (TU5JP4)		08/08-	K16HPR-U11	6076	1.1	KH16TT	IKH16TT	IKH16TT	4
1.6 16V	80	NFU (TU5JP4)		02/06-	K16HPR-U11	6076	1.1	KH16TT	IKH16TT	IKH16TT	4
1.6 16V	88	5FS (EP6C); EP6		02/07-	VXUH22	5611	0.9	-	-	VXUH22	4
1.6 16V RC	128	5FY (EP6DTS)		02/07-	VXUH22	5611	0.9	-	-	VXUH22	4
1.6 16V Turbo	110/115	5FR (EP6DT); 5FX (EP6DT)		02/06-	VXUH22	5611	0.9	-	-	VXUH22	4
1.6 16V VTi	88	5FS (EP6C); EP6		02/07-	VXUH22	5611	0.9	-	-	VXUH22	4
1.6 Bioflex	83			01/08-	K20HR-U11	3381	1.1	KH20TT	IKH20TT	IKH20TT	4
1.6 HDi	66/68/80	9HP (DV6DTE); 9HV (DV6TED4); 9HX (DV6ATED4); 9HY (DV6TED4); 9HZ (DV6TED4)		02/06-	DG-180		11V				4
1.6 HDi	82	9HR (DV6C)		08/09-	DG-603		5V				4
1.6 HDi 110	82	9HR (DV6C)		08/09-	DG-180		11V				4
208 (12-)											
1.0	50			03/12-	IXUH22I	5356	0.9	-	-	VXUH22I	3
1.2	60			03/12-	IXUH22I	5356	0.9	-	-	VXUH22I	3
1.4	70	8FS (EP3); EP3C		03/12-	VXUH22	5611	0.9	-	-	VXUH22	4
1.4 HDi	50	8HP (DV4C); 8HR (DV4C)		03/12-	DG-603		5V				4
1.6	88/115	5FS (EP6C); 5FV (EP6DT); EP6CDT		03/12-	VXUH22	5611	0.9	-	-	VXUH22	4
1.6 HDi	68/84	9HP (DV6DTE)		03/12-	DG-603		5V				4
301 (12-)											
1.2 VTi 72	53			11/12-	IXUH22I	5356	0.9	-	-	VXUH22I	3
1.6 HDi 90	68	9HF (DV6DTE)		11/12-	DG-603		5V				4
305 I (77-82)											
1.3	44	118 (XL5)		11/77-09/82	T20EPR-U	5032	0.8	T20TT	IT20TT	IT20TT	4
1.3	48	XL5		11/77-09/82	T20EP-U	5031	0.8	T20TT	IT20TT	IT20TT	4
1.5	54/65	117 (XR5S); 142 (XR5)		05/80-09/82	T20EP-U	5031	0.8	T20TT	IT20TT	IT20TT	4
1.5 Diesel	36	149 (XID)		11/77-09/82	DG-001		11V				4
305 II (82-90)											
1.1	43	XK5		11/82-12/88	T20EP-U	5031	0.8	T20TT	IT20TT	IT20TT	4
1.3	44	118 (XL5)		10/82-08/86	T20EPR-U	5032	0.8	T20TT	IT20TT	IT20TT	4
1.5	50/54	142 (XR5); 142 (XR5A)		10/82-10/86	T20EP-U	5031	0.8	T20TT	IT20TT	IT20TT	4
1.6	54/55	B1A (XU51C); BAZ (XU5CP)		11/86-12/88	Q20PR-U	3007	0.8	Q20TT	IQ20TT	IQ20TT	4
1.6	66/69/71	171 (XU5S)		09/83-08/87	T22EP-U	5040	0.8	-	-	-	4
1.9	72	DFZ (XU9J1)		11/86-12/88	Q20PR-U	3007	0.8	Q20TT	IQ20TT	IQ20TT	4
1.9	75	159 (XU9S)		10/82-10/87	T20EPR-U	5032	0.8	T20TT	IT20TT	IT20TT	4
1.9	72	DFZ (XU9J1)		11/86-07/87	T20EP-U	5031	0.8	T20TT	IT20TT	IT20TT	4
1.9 D	47/48	162 (XUD9); D9A (XUD9)		10/82-07/88	DG-001		11V				4
1.9 Diesel	47/48	162 (XUD9); D9A (XUD9)		10/82-12/88	DG-001		11V				4
306 (93-02)											
1.1	44	HDZ (TU1M)		07/95-05/01	K20TXR	5063	1.0	K20TT	IK20TT	IK20TT	4
1.1	44	HDZ (TU1M)		06/94-06/95	Q16PR-U	3137	0.8	Q16TT	IQ16TT	IQ16TT	4

	KW								QTY		
PEUGEOT <i>continued</i>											
306 (93-02) <i>continued</i>											
1.4	55	KFX (TU3JP)		07/95-04/02	K20TXR	5063	1.0	K20TT	IK20TT	IK20TT	4
1.4 SL	55	KFX (TU3JP)		07/95-05/01	K20TXR	5063	1.0	K20TT	IK20TT	IK20TT	4
1.6	65	NFZ (TU5JP)		05/93-10/00	K16PR-U	3191	0.8	K16TT	IK16TT	IK16TT	4
1.6	66/72	NFT		07/00-05/01	K20PR-U	3145	0.8	K20TT	IK20TT	IK20TT	4
1.6	72	NFT		10/00-04/02	K20TXR	5063	1.0	K20TT	IK20TT	IK20TT	4
1.6 SR	65	NFZ (TU5JP)		06/94-10/00	K16PR-U	3191	0.8	K16TT	IK16TT	IK16TT	4
1.8	74	LFZ (XU7JP)		07/95-04/02	K20TXR	5063	1.0	K20TT	IK20TT	IK20TT	4
1.8	74	LFZ (XU7JP)		05/93-06/95	Q20PR-U	3007	0.8	Q20TT	IQ20TT	IQ20TT	4
1.8 16V	81	LFY (XU7JP4)		03/97-04/02	K20TXR	5063	1.0	K20TT	IK20TT	IK20TT	4
1.8 D	43	A9A (XUD7)		05/93-05/01	DG-001		11V				4
1.8 ST	74	LFZ (XU7JP)		06/94-06/95	Q20PR-U	3007	0.8	Q20TT	IQ20TT	IQ20TT	4
1.9 D	47/ 50/ 51/ 55/ 69	DHV (XUD9BSD); DJY (XUD9A); DJZ (XUD9Y); XUD9TE		04/93-05/01	DG-001		11V				4
1.9 D	51	WJY (DW8B); WJZ (DW8)		09/98-04/02	DG-003		11V				4
1.9 DT	66	DHY (XUD9TE)		05/93-05/01	DG-001		11V				4
1.9 SLD	47/50	DJY (XUD9A); DJZ (XUD9Y)		06/94-05/01	DG-001		11V				4
1.9 SRDT	66	DHY (XUD9TE)		06/94-05/01	DG-001		11V				4
1.9 STD	51	XUD9		02/94-10/95	DG-001		11V				4
1.9 TD	66	DHY (XUD9TE)		02/97-04/02	DG-001		11V				4
2.0	89/97	RFV (XU10J4R); RFX (XU10J2)		03/97-04/02	K20TXR	5063	1.0	K20TT	IK20TT	IK20TT	4
2.0 16V	97	RFV (XU10J4R)		03/97-04/02	K20TXR	5063	1.0	K20TT	IK20TT	IK20TT	4
2.0 HDi 90	66	RHY (DW10TD)		06/99-04/02	DG-116		11V				4
2.0 S16	120	RFS (XU10J4RS)		03/96-05/01	K20TNR	3304	1.0	K20TT	IK20TT	IK20TT	4
2.0 S16	110/ 112	RFT (XU10J4); RFY (XU10J4Z)		05/93-05/01	Q22PR-U	3010	0.8	-	-	VQ22	4
2.0 ST	89	RFX (XU10J2)		07/94-05/01	K20TXR	5063	1.0	K20TT	IK20TT	IK20TT	4
2.0 XSi	89	RFX (XU10J2)		05/93-05/01	K20TXR	5063	1.0	K20TT	IK20TT	IK20TT	4
307 (00-)											
1.4	55	KFW (TU3JP)		09/01-06/05	K20PR-U	3145	0.8	K20TT	IK20TT	IK20TT	4
1.4 16V	65	KFU (ET3J4)		11/03-01/08	XE20HR-U9	3427	0.9	-	IXEH20TT	IXEH20TT	4
1.4 HDi	50	8HX (DV4TD); 8HZ (DV4TD)		10/01-	DG-113		11V				4
1.4 HDi 70	50	8HZ (DV4TD)		03/02-01/05	DG-113		11V				4
1.6	81			07/06-	K16HPR-U11	6076	1.1	KH16TT	IKH16TT	IKH16TT	4
1.6 16V	80	NFU (TU5JP4)		08/00-	K16HPR-U11	6076	1.1	KH16TT	IKH16TT	IKH16TT	4
1.6 BioFlex	80	NFU (TU5JP4)		09/07-	K20HR-U11	3381	1.1	KH20TT	IKH20TT	IKH20TT	4
1.6 HDi	66	9HV (DV6ATED4); 9HX (DV6ATED4)		04/05-	DG-113		11V				4
1.6 HDi	66	9HV (DV6ATED4); 9HX (DV6ATED4)		04/05-	DG-180		11V				4
1.6 HDi 110	80	9HY (DV6TED4); 9HZ (DV6TED4)		02/04-	DG-113		11V				4
1.6 HDi 110	80	9HY (DV6TED4); 9HZ (DV6TED4)		02/04-	DG-180		11V				4
1.6 HDi 90	66	9HV (DV6ATED4); 9HX (DV6ATED4)		12/06-	DG-113		11V				4
1.6 HDi 90	66	9HV (DV6ATED4); 9HX (DV6ATED4)		12/06-	DG-180		11V				4
2.0	100/ 105	RFN (EW10J4)		03/02-03/09	K16HPR-U11	6076	1.1	KH16TT	IKH16TT	IKH16TT	4
2.0 16V	100/ 103	RFJ (EW10A); RFN (EW10J4)		03/02-11/07	K16HPR-U11	6076	1.1	KH16TT	IKH16TT	IKH16TT	4
2.0 16V	130	RFK (EW10J4S)		10/03-03/09	K20HR-U11	3381	1.1	KH20TT	IKH20TT	IKH20TT	4
2.0 HDi 110	79	RHS (DW10ATED)		08/00-	DG-116		11V				4
2.0 HDi 135	100	RHR (DW10BTED4)		10/03-	DG-116		11V				4
2.0 HDi 135	100	RHR (DW10BTED4)		06/05-	DG-181		11V				4
2.0 HDi 90	66	RHY (DW10TD)		08/00-	DG-116		11V				4
308 I (07-)											
1.4 16V	70/72	8FS (EP3); EP3		09/07-	VXUH22	5611	0.9	-	-	VXUH22	4
1.6 16V	88/ 103/ 110/ 115/ 128	5FT (EP6DT); 5FX (EP6DT); 5FY (EP6DTS); EP6CDT		09/07-	VXUH22	5611	0.9	-	-	VXUH22	4
1.6 BioFlex	80/82	NFU (TU5JP4)		04/08-	K20HR-U11	3381	1.1	KH20TT	IKH20TT	IKH20TT	4
1.6 GTi	147	EP6CDTX		07/10-	VXUH22	5611	0.9	-	-	VXUH22	4

	KW				Standard			Twin Tip				QTY
PEUGEOT <i>continued</i>												
308 I (07-) <i>continued</i>												
1.6 HDi	66/80	9HV (DV6ATED4); 9HX (DV6ATED4); 9HZ (DV6TED4)		09/07-	DG-180		11V					4
1.6 HDi	68/82/84	9HP (DV6DTE); 9HR (DV6C)		11/09-	DG-603		5V					4
1.6 THP	147	EP6CDTX		10/10-	VXUH22	5611	0.9	-	-	VXUH22		4
2.0 Bioflex	103	RFJ (EW10A)		01/08-	K20HR-U11	3381	1.1	KH20TT	IKH20TT	IKH20TT		4
2.0 HDi	100/103	RHR (DW10BTED4)		09/07-	DG-181		11V					4
2.0 HDi	103/110/120	RHE (DW10CTED4); RHF (DW10BTED4); RHH (DW10CTED4); RHR (DW10BTED4)		04/09-	DG-603		5V					4
308 II (13-)												
1.6 BlueHDi 120	88	BHZ (DV6FC)		11/13-	DG-603		5V					4
1.6 HDi	68/85			09/13-	DG-603		5V					4
1.6 HDi 92	68			03/14-	DG-603		5V					4
2.0 BlueHDi 150	110			11/13-	DG-603		5V					4
309 I (85-89)												
1.1	40	E1		10/85-07/89	Q20PR-U	3007	0.8	Q20TT	IQ20TT	IQ20TT		4
1.3	47	G1A		10/85-07/89	Q20P-U	3125	0.8	Q20TT	IQ20TT	IQ20TT		4
1.4	55	KDY (TU3M); KDZ (TU3M)		03/89-07/89	K20PR-U	3145	0.8	K20TT	IK20TT	IK20TT		4
1.4	49	K1D (TU3A)		03/89-07/89	Q20P-U	3125	0.8	Q20TT	IQ20TT	IQ20TT		4
1.4	62	K2B (TU3S)		03/89-07/89	Q22P-U	3255	0.8	-	-	VQ22		4
1.5	63	Y2/K		06/87-12/89	Q20PR-U	3007	0.8	Q20TT	IQ20TT	IQ20TT		4
1.6	83			07/86-06/89	K20PR-U	3145	0.8	K20TT	IK20TT	IK20TT		4
1.6	53/76	180Z (XU5J); B1E (XU51C)		07/87-07/89	Q20PR-U	3007	0.8	Q20TT	IQ20TT	IQ20TT		4
1.6	69			01/86-07/89	Q20P-U	3125	0.8	Q20TT	IQ20TT	IQ20TT		4
1.6	55/59	B1A (XU51C)		10/85-07/89	T22EP-U	5040	0.8	-	-	-		4
1.6 CAT	55	BAZ (XU5CP)		09/86-12/89	Q20PR-U	3007	0.8	Q20TT	IQ20TT	IQ20TT		4
1.9	72/80	DDZ (XU9M); DFZ (XU9J1)		07/87-07/89	Q20PR-U	3007	0.8	Q20TT	IQ20TT	IQ20TT		4
1.9	75	D2B (XU9S)		10/85-07/89	T20EP-U	5031	0.8	T20TT	IT20TT	IT20TT		4
1.9 D	47	162 (XUD9); D9A (XUD9)		06/86-07/89	DG-001		11V					4
1.9 GTI	88/94	D6B (XU9JA); DKZ (XU9JAZ)		10/86-07/89	Q20PR-U	3007	0.8	Q20TT	IQ20TT	IQ20TT		4
309 II (89-93)												
1.1	44	HDZ (TU1M)		08/90-12/93	Q20PR-U	3007	0.8	Q20TT	IQ20TT	IQ20TT		4
1.1	40	H1B (TU1)		09/89-10/93	Q20R-U	3140	0.8	Q20TT	IQ20TT	IQ20TT		4
1.4	55	KDY (TU3M); KDZ (TU3M)		07/89-12/93	K20PR-U	3145	0.8	K20TT	IK20TT	IK20TT		4
1.4	49	K1D (TU3A)		07/90-10/92	Q20PR-U	3007	0.8	Q20TT	IQ20TT	IQ20TT		4
1.6	65/68	B2A (XU52C/K); BDY (XU5M2Z)		07/89-12/93	Q20PR-U	3007	0.8	Q20TT	IQ20TT	IQ20TT		4
1.6	69	B2A (XU52C/K)		07/89-12/91	Q20P-U	3125	0.8	Q20TT	IQ20TT	IQ20TT		4
1.6 GTi	85			09/89-10/93	K20PR-U	3145	0.8	K20TT	IK20TT	IK20TT		4
1.8 Diesel	44	161A (XUD7)		07/89-12/93	DG-001		11V					4
1.9	72/80	DDZ (XU9M); DFZ (XU9J1)		08/89-12/93	Q20PR-U	3007	0.8	Q20TT	IQ20TT	IQ20TT		4
1.9 Diesel	47	162 (XUD9); D9A (XUD9); DJZ (XUD9Y)		07/89-12/93	DG-001		11V					4
1.9 GTI	88	DKZ (XU9JAZ)		07/89-12/93	Q20PR-U	3007	0.8	Q20TT	IQ20TT	IQ20TT		4
1.9 GTI 16V	108/116	D6C (XU9J4); DFW (XU9J4Z)		08/89-12/93	K22PBR-S	5062	0.85	-	-	VK22		4
405 I (87-93)												
1.4	47	K5A (TU3)		01/87-07/92	Q20P-U	3125	0.8	Q20TT	IQ20TT	IQ20TT		4
1.6	68/69	B2A (XU52C/K)		05/88-08/92	K20PR-U	3145	0.8	K20TT	IK20TT	IK20TT		4
1.6	53/55/65/66/69	B1E (XU51C); B2A (XU52C/K); BAZ (XU5CP); BDY (XU5M2Z); BDZ (XU5M)		01/87-12/92	Q20PR-U	3007	0.8	Q20TT	IQ20TT	IQ20TT		4
1.6	66	BDZ (XU5M)		10/88-08/92	Q20P-U	3125	0.8	Q20TT	IQ20TT	IQ20TT		4
1.8 TD	66	A8A (XUD7TE); AJZ (XUD7TEY)		10/88-08/92	DG-001		11V					4
1.8 Turbo Diesel	66	A8A (XUD7TE); AJZ (XUD7TEY)		03/88-12/92	DG-001		11V					4











	KW					Standard		Twin Tip		QTY	
PEUGEOT <i>continued</i>											
405 I (87-93) <i>continued</i>											
1.9	77/80/88	DDZ (XU9M); DFZ (XU9J1); DKZ (XU9JAZ)		10/88-08/92	Q20PR-U	3007	0.8	Q20TT	IQ20TT	IQ20TT	4
1.9	70/72/80/90/93	D2C (XU92C); D6A (XU9J2); DDZ (XU9M); DFZ (XU9J1)		07/87-12/92	Q20P-U	3125	0.8	Q20TT	IQ20TT	IQ20TT	4
1.9 4x4	88/93	DKZ (XU9JAZ)		07/90-07/92	K20PR-U	3145	0.8	K20TT	IK20TT	IK20TT	4
1.9 4x4	80	DDZ (XU9M)		07/88-12/92	Q20PR-U	3007	0.8	Q20TT	IQ20TT	IQ20TT	4
1.9 4x4	80	DDZ (XU9M)		10/88-08/92	Q20P-U	3125	0.8	Q20TT	IQ20TT	IQ20TT	4
1.9 D	47/51	D9B (XUD9A); DJY (XUD9A); DJZ (XUD9Y)		10/88-08/92	DG-001		11V				4
1.9 Diesel	47/51	D9B (XUD9A); DJZ (XUD9Y)		03/88-12/92	DG-001		11V				4
1.9 Injection	77	DFZ (XU9J1)		07/87-12/92	Q20PR-U	3007	0.8	Q20TT	IQ20TT	IQ20TT	4
1.9 Sport MI-16	108/116	D6C (XU9J4); DFW (XU9J4Z)		07/87-12/92	K22PBR-S	5062	0.85	-	-	VK22	4
1.9 SPort MI-16 4x4	108	DFW (XU9J4Z)		04/88-12/92	K22PBR-S	5062	0.85	-	-	VK22	4
405 II (92-99)											
1.4	58	TU3.2(K2D)		07/93-06/94	K20PR-U	3145	0.8	K20TT	IK20TT	IK20TT	4
1.4	55	KDX (TU3MC)		08/92-10/96	Q20PR-U	3007	0.8	Q20TT	IQ20TT	IQ20TT	4
1.6	65	BDY (XU5M2Z)		08/92-10/96	Q20PR-U	3007	0.8	Q20TT	IQ20TT	IQ20TT	4
1.8	74	LFZ (XU7JP)		08/92-10/96	Q20PR-U	3007	0.8	Q20TT	IQ20TT	IQ20TT	4
1.9 D	47/50/51/52	D9B (XUD9A); DJY (XUD9A); DJZ (XUD9Y)		08/92-11/99	DG-001		11V				4
1.9 TD	66/69	DHY (XUD9TE)		08/92-05/97	DG-001		11V				4
2.0	89	RFX (XU10J2)		08/92-10/96	Q20PR-U	3007	0.8	Q20TT	IQ20TT	IQ20TT	4
2.0 4x4	89	RFX (XU10J2)		08/92-10/96	Q16PR-U	3137	0.8	Q16TT	IQ16TT	IQ16TT	4
2.0 MI-16	112	RFY (XU10J4Z)		08/92-10/95	K20PBR	5060	0.85	K20TT	IK20TT	IK20TT	4
2.0 T 16 X4	144	RGZ (XU10J4TE/Z)		08/92-10/95	K20TXR	5063	1.0	K20TT	IK20TT	IK20TT	4
2.0 X4	89	RFX (XU10J2)		08/92-10/95	Q16PR-U	3137	0.8	Q16TT	IQ16TT	IQ16TT	4
406 (95-04)											
1.6	65	BFZ (XU5JP)		11/95-03/99	K20TXR	5063	1.0	K20TT	IK20TT	IK20TT	4
1.8	66	LFX (XU7JB)		05/97-03/99	K20TXR	5063	1.0	K20TT	IK20TT	IK20TT	4
1.8 16V	85	6FZ (EW7J4)		10/00-10/04	K16HPR-U11	6076	1.1	KH16TT	IKH16TT	IKH16TT	4
1.8 16V	81	LFY (XU7JP4)		11/95-10/00	K20TXR	5063	1.0	K20TT	IK20TT	IK20TT	4
1.9 D	55	DHW (XUD9SD)		10/96-10/04	DG-001		11V				4
1.9 TD	66/68	DHX (XUD9TE); DHY (XUD9TE)		01/96-05/04	DG-001		11V				4
2.0 16V	99/100	RFN (EW10J4); RFR (DEW10J4)		01/99-06/04	K16HPR-U11	6076	1.1	KH16TT	IKH16TT	IKH16TT	4
2.0 16V	97	RFV (XU10J4R)		11/95-12/04	K20TXR	5063	1.0	K20TT	IK20TT	IK20TT	4
2.0 HDi 110	79/80	RHS (DW10ATED); RHZ (DW10ATED)		06/98-05/04	DG-116		11V				4
2.0 HDi 90	66	RHY (DW10TD)		02/99-10/04	DG-116		11V				4
2.0 Turbo	108	RGX (XU10J2TE)		04/96-10/04	K20TXR	5063	1.0	K20TT	IK20TT	IK20TT	4
2.1 TD 12V	80	P8C (XUD11BTE)		01/96-10/04	DG-001		11V				4
2.2	116	3FZ (EW12J4)		07/00-10/04	K16HPR-U11	6076	1.1	KH16TT	IKH16TT	IKH16TT	4
2.2	116	3FZ (EW12J4)		03/02-12/04	K20TXR	5063	1.0	K20TT	IK20TT	IK20TT	4
2.2 HDi	98	4HX (DW12TED4/FAP)		03/00-12/04	DG-116		11V				4
3.0 24V	140	XFZ (ES9J4)		10/96-10/04	K20TXR	5063	1.0	K20TT	IK20TT	IK20TT	6
3.0 V6	152	XFX (ES9J4S)		03/00-12/04	IKH16	5343	1.1	-	IKH16TT	IKH16TT	6
3.0 V6 24V	140	XFZ (ES9J4)		03/97-12/04	K20TXR	5063	1.0	K20TT	IK20TT	IK20TT	6
407 (04-)											
1.6 HDi 110	80	9HZ (DV6TED4)	Ch: >RPO 10783	05/04-05/06	DG-113		11V				4
1.6 HDi 110	80	9HZ (DV6TED4)	Ch: RPO 10784>	06/06-	DG-180		11V				4
1.8	85	6FZ (EW7J4)		05/04-	K16HPR-U11	6076	1.1	KH16TT	IKH16TT	IKH16TT	4
1.8 16V	92	6FY (EW7A)		09/05-12/09	K16HPR-U11	6076	1.1	KH16TT	IKH16TT	IKH16TT	4
2.0	100	RFN (EW10J4)		05/04-10/05	K16HPR-U11	6076	1.1	KH16TT	IKH16TT	IKH16TT	4
2.0 16V	103	RFJ (EW10A)		09/05-12/09	K16HPR-U11	6076	1.1	KH16TT	IKH16TT	IKH16TT	4
2.0 Bioflex	103	RFJ (EW10A)		09/07-	K16HPR-U11	6076	1.1	KH16TT	IKH16TT	IKH16TT	4
2.0 HDi	100/103	RHF (DW10BTED4); RHR (DW10BTED4)		05/07-05/11	DG-181		11V				4
2.0 HDi	110/120	RHE (DW10CTED4); RHH (DW10CTED4)		07/09-	DG-603		5V				4
2.0 HDi 135	100	RHR (DW10BTED4)		05/04-	DG-181		11V				4







	KW									QTY	
PEUGEOT <i>continued</i>											
407 (04-) <i>continued</i>											
2.2	116	3FZ (EW12J4)		05/04-	K16HPR-U11	6076	1.1	KH16TT	IKH16TT	IKH16TT	4
2.2 16V	120	3FY (EW12J4)		09/05-03/09	K16HPR-U11	6076	1.1	KH16TT	IKH16TT	IKH16TT	4
2.2 HDi	120	4HP (DW12BTED4)		06/08-12/09	DG-614		11V				4
2.2 HDi 170	125	4HT (DW12BTED4)		05/06-12/09	DG-614		11V				4
2.7 HDi	150	DT17TED4		10/05-	DG-140		11V				6
3.0	155	XFV (ES9A)		05/04-03/09	VKH16	5617	1.1	-	IKH16TT	IKH16TT	6
3.0 V6	155	XFV (ES9A)		10/05-03/09	VKH16	5617	1.1	-	IKH16TT	IKH16TT	6
504 (68-89)											
1.6	46	XC7P		01/80-06/87	W20EP-U	3043	0.8	W20TT	IW20TT	IW20TT	4
1.8	55	XM7		08/81-07/85	W20EPR-U	3047	0.8	W20TT	IW20TT	IW20TT	4
1.8	53	XM7		07/87-12/89	W20EP-U	3043	0.8	W20TT	IW20TT	IW20TT	4
1.8 (F01, E01)	54	XM7		04/71-07/86	W20EP-U	3043	0.8	W20TT	IW20TT	IW20TT	4
1.8 (M03)	58	XM7		01/71-06/83	W20EP-U	3043	0.8	W20TT	IW20TT	IW20TT	4
1.9 D	40	XD4x88		01/80-12/89	DG-001		11V				4
1.9 D (M20)	40	XD4x88		07/79-07/86	DG-001		11V				4
2.0	75/78	107 (XN2)		08/77-08/84	Q20PR-U	3007	0.8	Q20TT	IQ20TT	IQ20TT	4
2.0 (A1, A13, MY1, MY3)	71	106 (XN1)		03/71-06/86	Q20PR-U	3007	0.8	Q20TT	IQ20TT	IQ20TT	4
2.0 (D11, F11)	68	XN1		04/71-07/86	W20EP-U	3043	0.8	W20TT	IW20TT	IW20TT	4
2.0 TI (A12, A14)	78	107 (XN2)		01/75-06/83	W20EP-U	3043	0.8	W20TT	IW20TT	IW20TT	4
2.1 D (A20, M20)	48	XD4x90		06/78-07/86	DG-001		11V				4
2.1 D (E20, F20)	48	XD4x90		04/71-07/86	DG-001		11V				4
2.3 D	51	134 (XD2)		01/80-12/89	DG-001		11V				4
2.3 D (A40, A45)	51	134 (XD2)		07/75-12/83	DG-001		11V				4
2.3 D (D40, F40)	51	134 (XD2)		07/75-07/86	DG-001		11V				4
2.7	106	140 (ZMJ)		10/77-08/84	T20EP-U	5031	0.8	T20TT	IT20TT	IT20TT	6
505 (79-95)											
1.8	55/ 60/ 62	105 (XM7); 105C (XM7A)		06/81-10/86	Q20PR-U	3007	0.8	Q20TT	IQ20TT	IQ20TT	4
2.0	60/71	106 (XN1)		11/80-11/87	Q20PR-U	3007	0.8	Q20TT	IQ20TT	IQ20TT	4
2.0	81	829 (ZEJ)		10/85-09/89	T22EP-U	5040	0.8	-	-	-	4
2.0	69/72	106 (XN1); 106E (XN1A)		08/83-11/87	W20EP-U	3043	0.8	W20TT	IW20TT	IW20TT	4
2.0 TI,STI	81	829 (ZEJ)		08/79-10/86	T22EP-U	5040	0.8	-	-	-	4
2.2	84	851X (ZDJL)		01/86-12/93	T22EP-U	5040	0.8	-	-	-	4
2.2 GTI	90/96	851B (ZDJL)		08/83-12/93	T22EP-U	5040	0.8	-	-	-	4
2.2 Turbo Injection	128	N9T;N9TE		06/87-12/88	W20EPB	5065	0.85	W20TT	IW20TT	IW20TT	4
2.2 Turbo Injection	110/ 114	176B (N9TE); 176X (N9TE)		03/84-10/88	W22EP-U	3085	0.8	W22TT	-	VW22	4
2.3 Diesel	59	147 (XD2S)		04/82-06/86	DG-001		11V				4
2.3 Turbo Diesel	59	147 (XD2S)		09/80-06/81	DG-001		11V				4
2.5 Diesel	51/55	155 (XD3)		08/83-12/93	DG-001		11V				4
2.5 Turbo Diesel	66/77	152A (XD3T); 152B (XD3TE)		10/83-12/93	DG-001		11V				4
2.8 GTI V6	105	154X (ZN3J)		06/86-12/93	T20EPR-U	5032	0.8	T20TT	IT20TT	IT20TT	6
508 (10-)											
1.6 HDi	82/84	9HD (DV6CTED); 9HR (DV6C)		11/10-	DG-603		5V				4
1.6 THP	115	EP6CDT		11/10-	VXUH22	5611	0.9	-	-	VXUH22	4
1.6 VTi	88	5FS (EP6C)		11/10-	VXUH22	5611	0.9	-	-	VXUH22	4
2.0 BlueHDi 150	110	AHX (DW10FD)		04/14-	DG-603		5V				4
2.0 BlueHDi 180	133	AHW (DW10FC)		04/14-	DG-603		5V				4
2.0 HDi	103	RHF (DW10BTED4)		11/10-	DG-181		11V				4
2.0 HDi	100/ 120	RHH (DW10CTED4); RHR (DW10BTED4)		11/10-	DG-603		5V				4
2.0 HDi Hybrid4 AWC	120/ 147	RHC (DW10CTED4)		11/10-	DG-603		5V				4
2.0 HDi RXH Hybrid4	147	RHC (DW10CTED4)		12/11-	DG-603		5V				4
604 (77-87)											
2.0	70			03/83-01/84	K20PR-U	3145	0.8	K20TT	IK20TT	IK20TT	4
2.3 TD	59	147 (XD2S)		09/79-05/83	DG-001		11V				4
2.5 TD	66	152A (XD3T)		08/83-12/86	DG-001		11V				4
2.7 SL	100	112 (ZM)		08/77-05/83	T20EPR-U	5032	0.8	T20TT	IT20TT	IT20TT	6
2.7 TI,STI	106	140 (ZMJ)		08/77-05/83	T20EPR-U	5032	0.8	T20TT	IT20TT	IT20TT	6
2.8 GTI	110	154A (ZMJK)		09/83-07/87	T20EPR-U	5032	0.8	T20TT	IT20TT	IT20TT	6
605 (89-99)											
2.0	79/89	RFZ (XU10J2Z)		06/89-09/99	Q20PR-U	3007	0.8	Q20TT	IQ20TT	IQ20TT	4
2.0	84	R5A (XU102C)		06/89-06/94	Q22PR-U	3010	0.8	-	-	VQ22	4
2.0 16V	97	RFV (XU10J4R)		07/94-09/99	K20TXR	5063	1.0	K20TT	IK20TT	IK20TT	4

	KW										QTY
PEUGEOT <i>continued</i>											
605 (89-99) <i>continued</i>											
2.0 Turbo	104/108	RGX (XU10J2TE); RGY (XU10J2TE)		07/91-09/99	K20TXR	5063	1.0	K20TT	IK20TT	IK20TT	4
2.1 D	60	P9A (XUD11A)		06/89-07/95	DG-001		11V				4
2.1 TD 12V	80	P8C (XUD11BTE)		08/94-09/99	DG-001		11V				4
2.1 Turbo Diesel	80	PHZ (XUD11ATE)		06/89-09/99	DG-001		11V				4
2.5 Turbo Diesel	95	THY (DK5ATE)		07/94-09/99	DG-001		11V				4
3.0	123/147	UFZ (ZPJ)		08/89-06/94	K20PBR	5060	0.85	K20TT	IK20TT	IK20TT	6
3.0 SV 24	147	UKZ (ZPJ4/Z)		08/89-09/99	K20PBR	5060	0.85	K20TT	IK20TT	IK20TT	6
607 (00-)											
2.0	100	RFN (EW10J4)		02/00-09/04	K16HPR-U11	6076	1.1	KH16TT	IKH16TT	IKH16TT	4
2.0 HDi	79/80	RHS (DW10ATED); RHZ (DW10ATED)		05/00-	DG-116		11V				4
2.0 HDi	100	RHR (DW10BTED4)		09/05-	DG-181		11V				4
2.2 16V	116/120	3FY (EW12J4); 3FZ (EW12J4)		02/00-11/07	K16HPR-U11	6076	1.1	KH16TT	IKH16TT	IKH16TT	4
2.2 HDi	98	4HX (DW12TED4/FAP)		02/00-	DG-116		11V				4
2.7 HDi 24V	150	DT17TED4		12/04-	DG-140		11V				6
3.0 V6 24V	152/155	XFV (ES9A); XFX (ES9J4S)		02/00-03/09	VKH16	5617	1.1	-	IKH16TT	IKH16TT	6
806 (94-02)											
1.8	73	LFW (XU7JP)		07/95-08/02	K20TXR	5063	1.0	K20TT	IK20TT	IK20TT	4
1.9 TD	66/68	DHX (XUD9TE); DHY (XUD9TE)		07/95-08/02	DG-001		11V				4
2.0	89	RFU (XU10J2)		06/94-08/02	K20TXR	5063	1.0	K20TT	IK20TT	IK20TT	4
2.0 16V	100	RFN (EW10J4)		09/00-08/02	K16HPR-U11	6076	1.1	KH16TT	IKH16TT	IKH16TT	4
2.0 16V	97	RFV (XU10J4R)		05/98-09/00	K20TXR	5063	1.0	K20TT	IK20TT	IK20TT	4
2.0 HDi	80	RHZ (DW10ATED)		08/99-08/02	DG-116		11V				4
2.0 HDi 16V	80	RHW (DW10ATED4)		08/99-08/02	DG-116		11V				4
2.0 Turbo	108	RGX (XU10J2TE)		06/94-08/02	K20TXR	5063	1.0	K20TT	IK20TT	IK20TT	4
2.1 td 12V	80	P8C (XUD11BTE)		06/96-08/99	DG-001		11V				4
807 (02-)											
2.0	100	RFN (EW10J4)		06/02-10/05	K16HPR-U11	6076	1.1	KH16TT	IKH16TT	IKH16TT	4
2.0 16V	103	RFJ (EW10A)		09/05-	K16HPR-U11	6076	1.1	KH16TT	IKH16TT	IKH16TT	4
2.0 HDi	79	RHM (DW10ATED4); RHT (DW10ATED4); RHW (DW10ATED4)		06/02-	DG-116		11V				4
2.0 HDi	88/100	RHK (DW10UTED4); RHR (DW10BTED4)		02/06-	DG-181		11V				4
2.0 HDi	120	RHH (DW10CTED4)		06/09-	DG-603		5V				4
2.2	116	3FZ (EW12J4)		06/02-09/05	K16HPR-U11	6076	1.1	KH16TT	IKH16TT	IKH16TT	4
2.2 HDi	120/125	4HT (DW12BTED4)		06/06-	DG-614		11V				4
2.2 HDi	94	4HX (DW12TED4/FAP)	Ch: >09666	06/02-04/03	DG-116		11V				4
2.2 HDi	94	4HX (DW12TED4/FAP)	Ch: 09667>	06/02-06/06	DG-181		11V				4
3.0 V6	150	XFX (ES9J4S)		06/02-09/05	VKH16	5617	1.1	-	IKH16TT	IKH16TT	6
1007 (05-)											
1.4	54	KFV (TU3JP)		04/05-07/10	K20PR-U	3145	0.8	K20TT	IK20TT	IK20TT	4
1.4 16V	65	KFU (ET3J4)		10/05-07/07	XE20HR-U9	3427	0.9	-	IXEH20TT	IXEH20TT	4
1.4 HDi	50	8HX (DV4TD); 8HZ (DV4TD)		04/05-	DG-113		11V				4
1.4 HDi	50	8HX (DV4TD); 8HZ (DV4TD)		04/05-	DG-180		11V				4
1.6 16V	80	NFU (TU5JP4)		04/05-	K16HPR-U11	6076	1.1	KH16TT	IKH16TT	IKH16TT	4
1.6 HDi	80	9HZ (DV6TED4)		06/07-	DG-180		11V				4
2008 (13-)											
1.2 VTi	60			03/13-	IXUH22I	5356	0.9	-	-	VXUH22I	3
1.4 HDi	50	8HR (DV4C)		06/13-	DG-603		5V				4
1.6 HDi	68/84	9HD (DV6CTED); 9HP (DV6DTE)		03/13-	DG-603		5V				4
1.6 VTi	88	5FS (EP6C)		03/13-	VXUH22	5611	0.9	-	-	VXUH22	4
3008 (09-)											
1.6 BlueHdi	88	BHZ (DV6FC)		05/14-	DG-603		5V				4
1.6 HDi	80	9HZ (DV6TED4)		06/09-	DG-180		11V				4
1.6 HDi	82/84	9HD (DV6CTED); 9HR (DV6C)		08/10-	DG-603		5V				4
1.6 THP	110/115	5FV (EP6DT); 5FX (EP6DT)		06/09-	VXUH22	5611	0.9	-	-	VXUH22	4

Spark & Glow Plugs



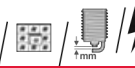

Application Tables

	KW										QTY
PEUGEOT <i>continued</i>											
3008 (09-) <i>continued</i>											
1.6 VTi	88	5FS (EP6C); EP6		06/09-	VXUH22	5611	0.9	-	-	VXUH22	4
2.0 HDi	100/ 110/ 120	RHE (DW10CTED4); RHH (DW10CTED4)		06/09-	DG-603		5V				4
2.0 HDi Hybrid4	120/ 147	RHH (DW10CTED4)		02/11-	DG-603		5V				4
4007 (07-)											
2.0	108	4B11		11/10-	VFK20F			-	IK20TT	IK20TT	4
2.0 4x4	108	4B11		11/10-	VFK20F			-	IK20TT	IK20TT	4
2.2 HDi	115	4HK (DW12MTED4); 4HN (DW12MTED4)		02/07-	DG-614		11V				4
2.4 16V	125			01/08-06/10	K16PSR-B8	3437	0.8	-	IK16TT	IK16TT	4
4008 (12-)											
1.6 HDi AWC	84			05/12-	DG-603		5V				4
2.0	110	4B11		05/13-	VFK20F			-	IK20TT	IK20TT	4
2.0 AWC	110	4B11		05/12-	VFK20F			-	IK20TT	IK20TT	4
5008 (09-)											
1.6 16V	88/ 115	5FS (EP6C); EP6; EP6CDT		09/09-	VXUH22	5611	0.9	-	-	VXUH22	4
1.6 HDi	80	9HZ (DV6TED4)		09/09-	DG-180		11V				4
1.6 HDi	82/84	9HD (DV6CTED); 9HR (DV6C)		08/10-	DG-603		5V				4
2.0 HDi	100/ 110/ 120	RHE (DW10CTED4); RHH (DW10CTED4)		09/09-	DG-603		5V				4
BIPPER (08-)											
1.3 HDi 75	55	199 A9.000		10/10-	DG-171		11V				4
1.4	54	KFV (TU3A)		02/08-	K20PR-U	3145	0.8	K20TT	IK20TT	IK20TT	4
1.4 HDi	50	8HS (DV4TED)		02/08-	DG-180		11V				4
BOXER (94-02)											
1.9 D	50/51	D9B (XUD9AU); DJY (XUD9A)		03/94-04/02	DG-001		11V				4
1.9 TD	66/68	D8C (XUD9UTF); DHY (XUD9TE)		08/94-04/02	DG-001		11V				4
1.9 TD 4x4	68	D8C (XUD9UTF)		07/96-04/02	DG-001		11V				4
2.0 4x4	80			03/96-09/98	K20TXR	5063	1.0	K20TT	IK20TT	IK20TT	4
2.0 HDi	62	RHV (DW10UTD)		08/01-04/02	DG-116		11V				4
2.0 i	80	RFW (XU10J2)		06/94-04/02	K20TXR	5063	1.0	K20TT	IK20TT	IK20TT	4
2.0 i	80	RFW (XU10J2)		03/94-03/95	Q20PR-U	3007	0.8	Q20TT	IQ20TT	IQ20TT	4
2.0 i 4x4	80	RFW (XU10J2)		08/96-04/02	K20TXR	5063	1.0	K20TT	IK20TT	IK20TT	4
2.5 D	63	T9A (DJ5)		03/94-04/02	DG-001		11V				4
2.5 D 4x4	63	T9A (DJ5)		07/96-04/02	DG-001		11V				4
2.5 TD	76	T8A (DJ5T)		03/94-04/02	DG-001		11V				4
2.5 TD 4x4	76	T8A (DJ5T)		07/96-04/02	DG-001		11V				4
2.5 TDI	79	THX (DJ5TED)		01/97-04/02	DG-161		11V				4
2.5 TDI 4x4	79	THX (DJ5TED)		01/97-04/02	DG-161		11V				4
2.8 HDi	93/94	8140.43S (F28DTCR)		10/00-04/02	DG-111		11V				4
2.8 HDi 4x4	93/94	8140.43S (F28DTCR)		10/00-04/02	DG-111		11V				4
BOXER (02-)											
2.0	81	RFL (XU10J2U)		04/02-06/06	K20PR-U	3145	0.8	K20TT	IK20TT	IK20TT	4
2.0 HDi	62	RHV (DW10TD); RHV (DW10UTD)		04/02-	DG-116		11V				4
2.2 HDi	74	4HY (DW12UTED)		04/02-	DG-116		11V				4
2.8 HDi	94/ 107	8140.43N; 8140.43S (F28DTCR)		04/02-	DG-111		11V				4
2.8 HDi 4x4	94	8140.43S (F28DTCR)		04/02-	DG-111		11V				4
BOXER (06-)											
2.2 HDi 100	74	4HV (P22DTE)		04/06-	DG-130		11.5V				4
2.2 HDi 120	88	4HU (P22DTE)		04/06-	DG-130		11.5V				4
3.0 HDi	115			07/06-	DG-195		11V				4
3.0 HDi 145	107			04/10-	DG-195		11V				4
3.0 HDi 160	116	F1CE0481D (F30DT)		04/06-	DG-195		11V				4
3.0 HDi 175	130			03/11-	DG-195		11V				4
EXPERT (96-)											
1.6	58	222A2 (1580 SPI)		02/96-09/00	Q22PR-U	3010	0.8	-	-	VQ22	4
1.8	74	LFZ (XU7JP)		10/96-09/00	K16HPR-U11	6076	1.1	KH16TT	IKH16TT	IKH16TT	4
1.9 D	51	D9B (XUD9AU)		02/96-	DG-001		11V				4
1.9 D 70	51	WJY (DW8B); WJZ (DW8)		12/98-	DG-003		11V				4
1.9 TD	66/68	D8B (XUD9TE); DHX (XUD9TE)		02/96-	DG-001		11V				4

	KW								QTY		
PEUGEOT <i>continued</i>											
EXPERT (96-) <i>continued</i>											
2.0	100	RFN (EW10J4)		07/00-	K16HPR-U11	6076	1.1	KH16TT	IKH16TT	IKH16TT	4
2.0 HDI	69/80	RHW (DW10ATED4); RHX (DW10BTED4); RHZ (DW10ATED4); RHZ (DW10BTED4); RHZ (DW10CTED4)		07/00-	DG-116		11V				4
2.0 HDi	69/80	RHW (DW10ATED4); RHX (DW10BTED4)		10/00-12/03	DG-181		11V				4
2.0 HDI 16V	80	RHW (DW10ATED4)		07/00-	DG-116		11V				4
EXPERT (07-)											
1.6 HDi 90	66	9HU (DV6UTED4)		01/07-	DG-180		11V				4
1.6 HDi 90 16V	66	9HU (DV6UTED4)		01/07-	DG-180		11V				4
2.0 16V	103	RFH (EW10A); RFJ (EW10A)		01/07-	K16HPR-U11	6076	1.1	KH16TT	IKH16TT	IKH16TT	4
2.0 HDi 100	72			03/11-	DG-603		5V				4
2.0 HDi 120	88	RHK (DW10UTED4)		01/07-	DG-181		11V				4
2.0 HDi 120	88	RHK (DW10UTED4)	OE: 5960F4	01/07-	DG-181		11V				4
2.0 HDi 120 4x4	88	RHK (DW10UTED4)		01/07-	DG-181		11V				4
2.0 HDi 130	94	AHZ (DW10CD)		03/11-	DG-603		5V				4
2.0 HDi 140	100	RHR (DW10BTED4)		01/07-	DG-181		11V				4
2.0 HDi 165	120	RHH (DW10CTED4)		09/09-	DG-603		5V				4
J5 (81-90)											
1.8	51	169B (XM7T)		01/83-11/88	Q20PR-U	3007	0.8	Q20TT	IQ20TT	IQ20TT	4
1.8	51	169B (XM7T)	Flexible fuel	01/83-11/88	W20EPR-U	3047	0.8	W20TT	IW20TT	IW20TT	4
2.0	55/58	170 (XN1T); 170B (XN1T)		01/83-11/88	Q20PR-U	3007	0.8	Q20TT	IQ20TT	IQ20TT	4
2.0	58	XN1P		09/81-08/90	W20EP-U	3043	0.8	W20TT	IW20TT	IW20TT	4
2.0	58	170 (XN1T)	LPG / GPL	01/83-11/88	Q20PR-U	3007	0.8	Q20TT	IQ20TT	IQ20TT	4
2.5 D	54	CRD93 (U25/661)		09/81-09/90	DG-001		11V				4
J5 (90-94)											
1.8	51	169B (XM7T)		09/90-01/94	Q20PR-U	3007	0.8	Q20TT	IQ20TT	IQ20TT	4
1.9 D	51	D9B (XUD9A)		10/90-03/94	DG-001		11V				4
2.0	62	170D (XN1TACP)		10/90-02/94	Q20PR-U	3007	0.8	Q20TT	IQ20TT	IQ20TT	4
2.0	62	170D (XN1TACP); XN1TA		09/90-01/94	W20EP-U	3043	0.8	W20TT	IW20TT	IW20TT	4
2.5 D	54	CRD93 (U25/661)		10/90-02/94	DG-001		11V				4
2.5 D 4x4	54	CRD93 (U25/661)		10/90-03/94	DG-001		11V				4
2.5 TD	70	CRD93LS (U25/673)		10/90-02/94	DG-001		11V				4
2.5 TD 4x4	70	CRD93LS (U25/673)		10/90-03/94	DG-001		11V				4
J7 (68-80)											
1.6	44	XC7P		08/68-03/80	W20EP-U	3043	0.8	W20TT	IW20TT	IW20TT	4
1.8	48	XM7P		04/72-03/80	W20EPR-U	3047	0.8	W20TT	IW20TT	IW20TT	4
2.3 D	49	XD2P94		07/77-03/80	DG-001		11V				4
J9 (80-87)											
1.6	44	XC7P		03/80-06/87	W20EP-U	3043	0.8	W20TT	IW20TT	IW20TT	4
2.0	57	XN1P		03/80-06/87	W20EP-U	3043	0.8	W20TT	IW20TT	IW20TT	4
2.1 D	41	XDPX90		03/80-06/87	DG-001		11V				4
2.3 D	49	XD2PX94		03/80-07/82	DG-001		11V				4
2.5 D	53	XD3P		07/82-06/87	DG-001		11V				4
PARTNER / RANCH (96-)											
1.1	44	HDZ (TU1M); HFX (TU1JP)		06/96-	K20TXR	5063	1.0	K20TT	IK20TT	IK20TT	4
1.4	54	KFV (TU3A); KFW (TU3JP)		11/02-10/06	K20PR-U	3145	0.8	K20TT	IK20TT	IK20TT	4
1.4	55	TU32		06/96-	K20TXR	5063	1.0	K20TT	IK20TT	IK20TT	4
1.4	55	TU32		06/96-	Q20PR-U	3007	0.8	Q20TT	IQ20TT	IQ20TT	4
1.4	54	KFW (TU3JP)	Flexible fuel	11/02-10/06	K20PR-U	3145	0.8	K20TT	IK20TT	IK20TT	4
1.4 BiFuel	55	KFW (TU3JP)	Flexible fuel	04/03-05/08	K20PR-U	3145	0.8	K20TT	IK20TT	IK20TT	4
1.6	80	NFU (TU5JP4)		09/00-10/02	K16HPR-U11	6076	1.1	KH16TT	IKH16TT	IKH16TT	4
1.6 16V	80	NFU (TU5JP4)		07/01-	K16HPR-U11	6076	1.1	KH16TT	IKH16TT	IKH16TT	4
1.6 HDi 75	55	9HW (DV6BTED4)		02/06-	DG-113		11V				4
1.6 HDi 75	55	9HW (DV6BTED4)	Ch: >RPO 10783	02/06-05/06	DG-113		11V				4
1.6 HDi 75	55	9HW (DV6BTED4)	Ch: RPO 10784>	05/06-	DG-180		11V				4
1.6 HDi 90	66	DV6ATED4 (9HX)	Ch: >ORP 10783	02/06-05/06	DG-113		11V				4
1.6 HDi 90	66	DV6ATED4 (9HX)	Ch: ORP 10784>	05/06-05/08	DG-180		11V				4
1.8	66	LFX (XU7JB)		05/97-08/00	K20TXR	5063	1.0	K20TT	IK20TT	IK20TT	4
1.8 D	43	A9A (XUD7)		06/96-	DG-001		11V				4







Spark & Glow Plugs

Application Tables

	KW				Standard			Twin Tip				QTY
PEUGEOT <i>continued</i>												
PARTNER / RANCH (96-) <i>continued</i>												
1.9 D	50/51	DJY (XUD9A)		05/96-	DG-001		11V					4
1.9 D	51	WJY (DW8B); WJZ (DW8)		06/96-	DG-003		11V					4
1.9 D 4x4	51	WJY (DW8B)		04/04-	DG-003		11V					4
2.0 HDi	66	RHY (DW10TD)		02/00-	DG-116		11V					4
2.0 HDi 4x4	66	RHY (DW10TD)		04/04-	DG-116		11V					4
PARTNER / RANCH (08-)												
1.6	66/80/81	NFR (TU5JP4B); NFU (TU5JP4)		04/08-	K16HPR-U11	6076	1.1	KH16TT	IKH16TT	IKH16TT		4
1.6	72/88	5FS (EP6C)		04/10-	VXUH22	5611	0.9	-	-	VXUH22		4
1.6 HDi	55/80	9HN (DV6TED4); 9HT (DV6BTED4); 9HW (DV6BTED4); 9HZ (DV6TED4)		04/08-	DG-180		11V					4
1.6 HDi	84	9HL (DV6C)		03/13-	DG-181		11V					4
1.6 HDi	82	9HL (DV6C)		08/10-	DG-603		5V					4
1.6 HDi 16V	66	9HS (DV6TED4BU); 9HV (DV6TED4); 9HX (DV6ATED4)		04/08-	DG-180		11V					4
1.6 HDi 90	68	9HP (DV6DTE)		04/10-	DG-603		5V					4
RCZ (10-)												
1.6 16V	115/147	EP6CDT; EP6CDTX		03/10-	VXUH22	5611	0.9	-	-	VXUH22		4
2.0 HDi	120	RHH (DW10CTED4)		03/10-	DG-603		5V					4
PIAGGIO												
PORTER (93-)												
1.0	33/35	CB41; CB42		02/93-07/02	W20EPR-U	3047	0.8	W20TT	IW20TT	IW20TT		3
1.2 D	26	LDW1204		05/95-	DG-001		11V					4
1.3 16V	48	HCEL		06/98-	K20TNR-S	3196	1.0	K20TT	IK20TT	IK20TT		4
1.3 16V 4x4	48	HCEL		06/98-	K20TNR-S	3196	1.0	K20TT	IK20TT	IK20TT		4
1.3 i 16V	48			05/98-	K20TNR-S	3196	1.0	K20TT	IK20TT	IK20TT		4
1.3 i 16V 4x4	48			05/98-	K20TNR-S	3196	1.0	K20TT	IK20TT	IK20TT		4
1.3 LPG	48	HCEL		06/98-	K20TNR-S	3196	1.0	K20TT	IK20TT	IK20TT		4
PININFARINA												
SPIDEREUROPA (82-85)												
2000	76/77	132C3.031		03/82-11/85	W20EPR-U	3047	0.8	W20TT	IW20TT	IW20TT		4
2000 Volumex	99	232R14		06/83-11/85	W20EPR-U	3047	0.8	W20TT	IW20TT	IW20TT		4
PLYMOUTH												
BREEZE (95-01)												
2.0 16V	98	ECB		12/95-04/01	K20PR-U	3145	0.8	K20TT	IK20TT	IK20TT		4
2.4 16V	103/112	EDZ		12/95-04/01	K16R-U11	3120	1.1	K16TT	IK16TT	IK16TT		4
NEON (94-)												
2.0	98	ECB		10/94-09/99	K20PR-U	3145	0.8	K20TT	IK20TT	IK20TT		4
2.0 16V	98	ECB		05/94-	K20PR-U	3145	0.8	K20TT	IK20TT	IK20TT		4
VOYAGER (89-90)												
3.3 LE	112	EGA		10/89-09/90	W16EXR-U13	3213	1.3	W16TT	IW16TT	IW16TT		6
VOYAGER (95-01)												
3.3 Flex-Fuel	116	EGM		01/98-03/01	P16R13	3239	1.3	W20TT	IW20TT	IW20TT		6
3.3 i	116	EGM		01/95-03/01	P16R13	3239	1.3	W20TT	IW20TT	IW20TT		6
PONTIAC												
BONNEVILLE (86-)												
3.8 V6	122	LG3		09/86-	T16EPR-U	5022	0.8	T16TT	IT16TT	IT16TT		6
FIREBIRD (81-92)												
3.1	104	LH0		01/87-12/89	T20PR-U11	5036	1.1	-	ITF20TT	ITF20TT		6
5.0	127	E-TBI		09/87-12/89	T16PR-U	5025	0.9	-	ITF16TT	ITF16TT		8
5.0	112	LG4		12/81-10/89	T16PR-U11	5026	1.1	-	ITF16TT	ITF16TT		8
FIREBIRD (92-)												
3.4	119	L32		11/92-	T20PR-U15	5037	1.5	-	ITF20TT	ITF20TT		6
TRANS SPORT (89-97)												
2.3	101/108			01/93-03/97	Q20PR-U	3007	0.8	Q20TT	IQ20TT	IQ20TT		4
3.1	90	LG6		07/89-03/97	T16PR-U15	5027	1.5	-	ITF16TT	ITF16TT		6
3.8	112/123/127	L27		07/89-03/97	T20EPR-U15	5033	1.5	T20TT	IT20TT	IT20TT		6
TRANS SPORT (97-)												
3.4	137	LA1		09/98-	PT16EPR-L13	5070	1.3	-	IT16TT	IT16TT		6











Spark & Glow Plugs







Application Tables

	KW					Standard		Twin Tip		QTY	
PORSCHE											
356 (50-68)											
1300	32			01/50-12/55	W22FS-U	4025	0.7	-	-	4	
1300 S	44			01/50-12/55	W22FS-U	4025	0.7	-	-	4	
A 1500 GS Carrera	73/ 74/ 77/ 81	547/1		01/55-12/61	W24ESR-U	4033	0.8	-	-	4	
A 1600	44			01/55-12/59	W22FS-U	4025	0.7	-	-	4	
A 1600 GS Carrera	85			01/55-12/61	W22FS-U	4025	0.7	-	-	4	
A 1600 S	55	616.15		01/55-12/59	W22FS-U	4025	0.7	-	-	4	
A 1600 Super	55	616.15		01/55-12/59	W22FS-U	4025	0.7	-	-	4	
B 1600	44			01/59-12/63	W22FPR-U	4022	0.7	-	-	4	
B 1600 Super 75	55	616.15		01/59-12/63	W22FPR-U	4022	0.7	-	-	4	
B 1600 Super 90	66			01/59-12/63	W22FPR-U	4022	0.7	-	-	4	
B 2000 GS Carrera 2	96/ 103	587/1		01/59-12/64	W22FPR-U	4022	0.7	-	-	4	
C 1600	55	616.15		01/63-12/65	W22FPR-U	4022	0.7	-	-	4	
C 1600 SC	70			01/63-12/65	W22FPR-U	4022	0.7	-	-	4	
C 2000 GS Carrera 2	96	587/1		01/61-12/64	W22FPR-U	4022	0.7	-	-	4	
C 2000 GS Carrera 2	103			10/61-03/68	W22FPR-U	4022	0.7	-	-	4	
911 (901, 911) (63-79)											
2.0 E	103	901.09; 901.11		09/68-02/72	IW27	5317	0.7	-	-	6	
2.0 L	110			08/67-11/68	IW27	5317	0.7	-	-	6	
2.0 L	96	901.01; 901.05; 901.06; 901.07; 901.14; 901.17		01/63-11/68	W22FPR-U	4022	0.7	-	-	6	
2.0 S	118	901.02; 901.08		07/66-11/68	IW24	5316	0.7	-	-	6	
2.0 S	125	901.10		07/66-02/72	IW27	5317	0.7	-	-	6	
2.0 T	81	901.03; 901.13		06/67-02/72	IW24	5316	0.7	-	-	6	
2.2 E	114	911.01; 911.04		09/69-02/72	IW27	5317	0.7	-	-	6	
2.2 S	132	911.02		09/69-02/72	IW27	5317	0.7	-	-	6	
2.2 T	92	911.03; 911.06; 911.07; 911.08		01/70-12/72	IW24	5316	0.7	-	-	6	
2.3 E	121	911.52; 911.62		08/71-12/73	IW27	5317	0.7	-	-	6	
2.3 S	140	911.53; 911.63		08/71-01/76	IW27	5317	0.7	-	-	6	
2.3 T	96	911.57; 911.67		01/72-12/73	IW24	5316	0.7	-	-	6	
2.3 T	103	911.51; 911.61; 911.91; 911.96		08/71-12/73	IW27	5317	0.7	-	-	6	
2.7	110	911.41; 911.46; 911.92; 911.97		09/73-08/75	IW22	5307	0.8	-	-	VW22	
2.7	121	911.43; 911.48; 911.81; 911.82; 911.84; 911.85; 911.86; 911.89; 911.90; 911.94; 911.99		09/75-06/77	IW24	5316	0.7	-	-	6	
2.7 S	129	911.42; 911.47; 911.93; 911.98		08/73-01/76	IW24	5316	0.7	-	-	6	
2.7 S Carrera	129	911.42; 911.47; 911.93; 911.98		08/73-01/76	IW24	5316	0.7	-	-	6	
2.7 SC Carrera RS	154	911.83		08/72-01/79	IW27	5317	0.7	-	-	6	
911 (930) (75-90)											
3.0 SC	150	930.10		08/80-07/83	IW27	5317	0.7	-	-	6	
3.0 SC Carrera	132	930.03; 930.13		07/77-06/80	IW24	5316	0.7	-	-	6	
3.0 SC Carrera	138/ 147/ 154	930.02; 930.09; 930.12; 930.19		03/74-10/83	IW27	5317	0.7	-	-	6	
3.0 Turbo	191	930.50; 930.52		01/75-12/77	IW27	5317	0.7	-	-	6	
3.1 Carrera Speedster	160/ 170	930.20; 930.25		08/86-08/89	IW24	5316	0.7	-	-	6	
3.1 SC Carrera	152/ 170	930.20; 930.21		08/83-08/89	IW24	5316	0.7	-	-	6	
3.2	160	930.25		08/86-08/89	IW24	5316	0.7	-	-	6	
3.2 SC Carrera	152/ 170	930.20; 930.21; 930.26		08/83-08/89	IW24	5316	0.7	-	-	6	
3.3 SC Turbo	221	930.60; 930.66		09/77-06/87	IW27	5317	0.7	-	-	6	
3.3 Turbo	221/ 243	930.60; 930.66		06/86-11/90	IW27	5317	0.7	-	-	6	
911 (964) (88-94)											
3.3 Turbo	235	M 30.69		08/90-09/93	IW20	5306	1.1	-	IW20TT	IW20TT	6
3.3 Turbo S	261	M 30.69S		06/91-12/92	IW20	5306	1.1	-	IW20TT	IW20TT	6
3.6 Carrera	184	M 64.01; M 64.02		07/89-05/94	K22PBR-S	5062	0.85	-	-	VK22	6
3.6 Carrera 4	184	M 64.01		12/88-05/94	K22PBR-S	5062	0.85	-	-	VK22	6
3.6 Carrera RS	191	M 64.03		06/91-09/93	K22PBR-S	5062	0.85	-	-	VK22	6

Spark & Glow Plugs









Application Tables







	KW										QTY
PORSCHE <i>continued</i>											
911 (964) (88-94) <i>continued</i>											
3.6 Turbo	265	M 64.50		01/93-09/93	K22PBR-S	5062	0.85	-	-	VK22	6
911 (993) (93-97)											
3.6 Carrera	200/210	M 64.05; M 64.06; M 64.07; M 64.08; M64.21		07/94-09/97	K22PBR-S	5062	0.85	-	-	VK22	6
3.6 Carrera 4	200/210	M 64.05; M 64.07; M 64.21; M 64.23; M64.05; M64.21		07/94-09/97	K22PBR-S	5062	0.85	-	-	VK22	6
3.6 Turbo 4	300	M 64.60		03/95-09/97	K22PBR-S	5062	0.85	-	-	VK22	6
3.6 Turbo GT2	316	M 64.60R		03/95-09/97	K22TNR-S	3197	1.0	-	-	VK22	6
3.6 Turbo GT2 4	316/331	M 64.60R		08/95-09/97	K22TNR-S	3197	1.0	-	-	VK22	6
3.8 Carrera	210/221	M 64.05S; M 64.06S; M 64.21S; M64.05S; M64.21S		06/95-09/97	K22PBR-S	5062	0.85	-	-	VK22	6
3.8 Carrera 4	210/221	M 64.05S; M 64.06S; M 64.21S; M64.05S; M64.21S		06/95-09/97	K22PBR-S	5062	0.85	-	-	VK22	6
3.8 Carrera RS	221	M 64.20		06/95-09/97	K22PBR-S	5062	0.85	-	-	VK22	6
911 (996) (97-05)											
3.4 Carrera	221/235	M 96.01; M 96.04		02/98-08/05	K20TXR	5063	1.0	K20TT	IK20TT	IK20TT	6
3.4 Carrera 4	221/235	M 96.01; M 96.02; M 96.04		09/97-08/05	K20TXR	5063	1.0	K20TT	IK20TT	IK20TT	6
3.6	235	M 96.03		12/01-08/05	IK22	5310	0.8	-	-	VK22	6
3.6 Carrera	235	M 96.03		10/01-08/05	IK22	5310	0.8	-	-	VK22	6
3.6 Carrera 4	235	M 96.03		10/01-08/05	IK22	5310	0.8	-	-	VK22	6
3.6 Carrera 4S	254	M 96.03		06/02-08/05	IK22	5310	0.8	-	-	VK22	6
3.6 Carrera S	254	M 96.03		06/02-08/05	IK22	5310	0.8	-	-	VK22	6
3.6 GT2	340/355	M 96.70		04/01-08/05	K22TNR-S	3197	1.0	-	-	VK22	6
3.6 GT3	265	M 96.76		03/99-08/05	K22TNR-S	3197	1.0	-	-	VK22	6
3.6 GT3	280	M 96.79		01/04-08/05	XU22EPR-U	3179	0.9	XU22TT	-	VXU22	6
3.6 GT3	280	M 96.79	14 mm diameter+	03/03-12/03	K22TNR-S	3197	1.0	-	-	VK22	6
3.6 S	331	M 96.70		08/04-08/05	K22TNR-S	3197	1.0	-	-	VK22	6
3.6 Turbo 4	309	M 96.70		06/00-08/05	K22TNR-S	3197	1.0	-	-	VK22	6
3.6 Turbo 4S	331	M 96.70		02/03-08/05	K22TNR-S	3197	1.0	-	-	VK22	6
911 (997) (04-12)											
3.6 Carrera	239	M 96.05		07/04-12/08	IK22	5310	0.8	-	-	VK22	6
3.6 Carrera 4	239	M 96.05		04/05-12/08	IK22	5310	0.8	-	-	VK22	6
3.6 GT 2	390	M 97.70S		09/07-12/12	VK22	5610	0.8	-	-	VK22	6
3.6 GT 3	305	M 97.76		03/06-12/09	IXU22	5308	0.9	-	-	VXU22	6
3.6 GT2 RS	456	M 97.70		05/10-12/12	VK22	5610	0.8	-	-	VK22	6
3.6 Turbo	353	M 97.70		03/06-12/09	VK22	5610	0.8	-	-	VK22	6
3.8 Carrera 4S	261/280	M 97.01; M 97.01S		04/05-12/08	K22PBR-S	5062	0.85	-	-	VK22	6
3.8 Carrera S	261/280	M 97.01S; M97.01		07/04-12/08	K22PBR-S	5062	0.85	-	-	VK22	6
3.8 Carrera S	261	M 97.01		04/05-12/08	PK22PR-L11S	3284	1.1	-	-	VK22G	6
912 (65-70)											
1.6	66	616.36; 616.39; 616.40		01/65-02/70	W22FPR-U	4022	0.7	-	-	-	4
914 (69-76)											
/6 2.0	81	901.36; 901.37		11/69-12/73	W20ESR-U	3057	0.8	-	-	-	6
1.7	59	W		01/69-12/73	W20ESR-U	3057	0.8	-	-	-	4
1.8	63	AN		08/73-02/76	W20ESR-U	3057	0.8	-	-	-	4
2.0	74	GB		01/72-12/75	W20ESR-U	3057	0.8	-	-	-	4
924 (75-89)											
2.0	92	047.8;047.9		11/75-08/79	W22EPR-U	3088	0.8	W22TT	-	VW22	4
2.0 Turbo	125/130	M 31.01; M 31.03		11/78-10/86	IW24	5316	0.7	-	-	-	4
2.5 S	120	M44.10		10/81-12/84	W20EPR-U	3047	0.8	W20TT	IW20TT	IW20TT	4
2.5 S	110/118	M 44.07; M 44.08; M44.09		09/85-07/88	W22EPR-U	3088	0.8	W22TT	-	VW22	4
944 (81-91)											
2.5	110/118/120	M 44.01; M 44.02; M 44.03; M 44.04; M 44.05; M 44.06; M 44.07; M 44.08; M 44.09; M 44.10		06/81-07/87	W20EPR-U	3047	0.8	W20TT	IW20TT	IW20TT	4
2.5 S	140	M 44.40		08/86-07/88	W20EPR-U	3047	0.8	W20TT	IW20TT	IW20TT	4

	KW					Standard			Twin Tip			QTY
PORSCHE <i>continued</i>												
944 (81-91) <i>continued</i>												
2.5 Turbo	162/184	M44.12		08/85-07/91	W22EPR-U	3088	0.8	W22TT	-	VW22		4
2.7	121	M44.12		11/88-08/89	W22EPR-U	3088	0.8	W22TT	-	VW22		4
3.0 S2	155	M 44.41		12/88-07/91	W22EPR-U	3088	0.8	W22TT	-	VW22		4
959 (86-91)												
2.8	330	959.50		01/86-04/91	X24ESR-U	4101	0.7	-	-	-		6
968 (91-95)												
3.0	176	M 44.43		06/91-11/95	W20EPBR-S	5067	0.85	W20TT	IW20TT	IW20TT		4
BOXSTER (986) (96-04)												
2.5	150	M 96.20		09/96-08/99	K20TNR	3304	1.0	K20TT	IK20TT	IK20TT		6
2.7	155/162/168	M 96.22; M 96.23		06/99-12/04	K20PBR-S10	5061	1.0	K20TT	IK20TT	IK20TT		6
S 3.2	191	M96.24		07/02-12/04	K20PBR-S10	5061	1.0	K20TT	IK20TT	IK20TT		6
S 3.2	185/196	M96.21; M96.21+266		08/99-12/04	K20PBR-S10	5061	1.0	K20TT	IK20TT	IK20TT		6
BOXSTER (987) (04-11)												
2.7	176/180	M 96.25; M 97.20		11/04-11/08	IK22	5310	0.8	-	-	VK22		6
S 3.2	206	M96.26		11/04-08/06	IK22	5310	0.8	-	-	VK22		6
S 3.4	217/223	M97.21; M97.22(303)		07/06-04/09	IK22	5310	0.8	-	-	VK22		6
CARRERA GT (03-06)												
5.7	450	M 80.01		07/03-12/06	IK24	5311	0.8	-	-	-		10
CAYENNE (955) (02-10)												
3.0 TDI	176	M 05.9D		02/09-09/10	DG-193		4.4V					6
3.2	184	M02.2Y		10/03-12/06	K20PBR-S10	5061	1.0	K20TT	IK20TT	IK20TT		6
3.6	213	M 55.01		02/07-09/10	VXUHC22G	5652	0.9	-	-	VXHUC22G		6
S 4.5	250	M48.00		09/02-12/06	K20PBR-S10	5061	1.0	K20TT	IK20TT	IK20TT		8
Turbo 4.5	331	M48.50		09/02-12/06	VK22	5610	0.8	-	-	VK22		8
Turbo S 4.5	368/383	M 48.50S; M48.50-521		01/04-12/06	VK22	5610	0.8	-	-	VK22		8
CAYENNE (10-)												
3.0 Diesel	155/176/180	M 05.9E; MCN.RB; MCR.C; MCR.CA; MCR.CB; MCV.VC		06/10-	DG-193		4.4V					6
CAYMAN (987) (05-)												
2.7	180	M97.20		07/06-11/08	IK22	5310	0.8	-	-	VK22		6
S 3.4	217	M97.21		11/05-11/08	IK22	5310	0.8	-	-	VK22		6
PROTON												
AEROBACK (88-96)												
1.3	50/55	4 G 13		10/88-11/96	W20EPR-U	3047	0.8	W20TT	IW20TT	IW20TT		4
1.5	66			01/91-11/96	IW16	5305	1.1	-	IW16TT	IW16TT		4
1.5	55	4 G 15		01/91-09/93	W20EPR-U	3047	0.8	W20TT	IW20TT	IW20TT		4
1.5 LX	66	4 G 15 M		10/88-11/96	IW16	5305	1.1	-	IW16TT	IW16TT		4
1.6 EX	70	4 G 92		10/88-11/96	K20PR-U11	3121	1.1	K20TT	IK20TT	IK20TT		4
GEN 2 (04-)												
1.3	70	S4PE		06/04-	T20EPR-U	5032	0.8	T20TT	IT20TT	IT20TT		4
1.6	82	S4PH		06/04-	T20EPR-U	5032	0.8	T20TT	IT20TT	IT20TT		4
IMPIAN (01-)												
1.6	76	4 G 18 P		09/01-	K20PR-U11	3121	1.1	K20TT	IK20TT	IK20TT		4
JUMBUCK (02-)												
1.5	64	4 G 15		05/02-	W16EPR-U	3021	0.8	W16TT	IW16TT	IW16TT		4
PERSONA 300 (96-)												
313i	55	G 13 B		03/96-	W20EPR-U	3047	0.8	W20TT	IW20TT	IW20TT		4
315 GLi/GLSi	66	4 G 15 M		03/96-	IW20	5306	1.1	-	IW20TT	IW20TT		4
315 GLSi	64	G 15 B		09/96-	W20EPR-U	3047	0.8	W20TT	IW20TT	IW20TT		4
316	70	4 G 92		03/96-	K20PR-U11	3121	1.1	K20TT	IK20TT	IK20TT		4
316 GLXi	83	4 G 92		03/96-	K20PR-U11	3121	1.1	K20TT	IK20TT	IK20TT		4
318 16V GTI	99	4 G 93		03/96-	VK20	5604	1.1	-	IK20TT	IK20TT		4
PERSONA 400 (94-)												
413	55			01/94-	W16EPR-U11	3201	1.1	W16TT	IW16TT	IW16TT		4
413 GLSi	55	4 G 13		01/94-	W16EPR-U11	3201	1.1	W16TT	IW16TT	IW16TT		4
415 GLi/GLSi	66	4 G 15		01/94-	W20EPR-U11	3049	1.1	W20TT	IW20TT	IW20TT		4
416	70	4 G 92		08/00-02/02	K20PR-U11	3121	1.1	K20TT	IK20TT	IK20TT		4
416 GLXi	83	4 G 92		01/94-	K20PR-U11	3121	1.1	K20TT	IK20TT	IK20TT		4
416 i	70	4 G 92		12/95-	K20PR-U11	3121	1.1	K20TT	IK20TT	IK20TT		4
418	85	4 G 93 (DOHC)		05/96-	K20PR-U11	3121	1.1	K20TT	IK20TT	IK20TT		4
418 GLXi	85	4 G 93 (DOHC)		05/96-	K20PR-U11	3121	1.1	K20TT	IK20TT	IK20TT		4
420 GLS D	48	4 D 68		05/96-	DG-301		11V					4

Spark & Glow Plugs









Application Tables







	KW					Standard 			Twin Tip 			QTY
PROTON <i>continued</i>												
SAGA I (88-07)												
1.3 GLE 12V	50	4 G 13		01/91-06/96	W20EPR-U	3047	0.8	W20TT	IW20TT	IW20TT		4
1.3 GLS 12V	50	4 G 13		01/91-06/96	W20EPR-U	3047	0.8	W20TT	IW20TT	IW20TT		4
1.5 GLE 12V	55	4 G 15		01/91-06/96	W20EPR-U	3047	0.8	W20TT	IW20TT	IW20TT		4
1.5 GLS 12V	55	4 G 15		01/91-06/96	W20EPR-U	3047	0.8	W20TT	IW20TT	IW20TT		4
SALOON (91-96)												
1.3	50	4 G 13		01/91-09/93	W20EPR-U	3047	0.8	W20TT	IW20TT	IW20TT		4
1.5	55/66	4 G 15		01/91-11/96	W20EPR-U	3047	0.8	W20TT	IW20TT	IW20TT		4
SATRIA (96-)												
1.5	64	4 G 15		07/00-	W16EPR-U	3021	0.8	W16TT	IW16TT	IW16TT		4
WIRA (00-)												
1.3	55	4 G 13		08/00-	W16EPR-U	3021	0.8	W16TT	IW16TT	IW16TT		4
1.5	64	4 G 15		08/00-	W16EPR-U	3021	0.8	W16TT	IW16TT	IW16TT		4
1.6	70	4 G 92		08/00-02/02	K20PR-U11	3121	1.1	K20TT	IK20TT	IK20TT		4
PUCH												
G-MODELL (W460) (79-92)												
230 G	75	M 115.973		02/80-07/87	W20EP-U	3043	0.8	W20TT	IW20TT	IW20TT		4
230 GE	92	M 102.981; M 102.987		04/82-08/92	T20EP-U	5031	0.8	T20TT	IT20TT	IT20TT		4
240 GD	53	OM 616.936		03/79-08/87	DG-001		11V					4
250 GD	62	OM 602.930		10/87-12/92	DG-010		11.5V					5
280 GE	110	M 110.994		08/84-08/89	W20PR-U	5046	0.7	-	-	-		6
300 GD	65	OM 617.931		12/79-12/91	DG-001		11V					5
G-MODELL (W461) (92-)												
230 GE	92	M 102.987		06/93-	T20EP-U	5031	0.8	T20TT	IT20TT	IT20TT		4
290 GD/G 290 D	70	OM 602.942		04/92-	DG-010		11.5V					5
G 290 TD	88	OM 602.983		07/97-	DG-010		11.5V					5
G-MODELL (W463) (89-)												
230 GE	93	M 102.989		06/90-06/93	T20EP-U	5031	0.8	T20TT	IT20TT	IT20TT		4
300 GD	83	OM 603.931		09/89-	DG-010		11.5V					6
300 GE	125	M 103.987		06/90-	T20EP-U	5031	0.8	T20TT	IT20TT	IT20TT		6
350 G Turbo D	100	OM 603.972		09/91-	DG-010		11.5V					6
G 300 TD	130	OM 606.964		08/96-	DG-106		11.5V					6
G 500	218	M 113.962		04/98-	PK16PR11	3264	1.1	K16TT	IK16TT	IK16TT		8
RANGER												
REKORD (72-78)												
1700	61	17 S		02/72-12/78	W20FPR-U	3070	0.7	WF20TT	-	-		4
1900	71	19 SH		02/72-12/78	W20FPR-U	3070	0.7	WF20TT	-	-		4
2500	85	25 S		02/72-12/78	W20FPR-U	3070	0.7	WF20TT	-	-		6
2500 GTS	96	25 H		02/72-12/78	W20FPR-U	3070	0.7	WF20TT	-	-		6
RELIANT												
KITTEN (75-83)												
850	30			01/75-12/83	W16EPR-U	3021	0.8	W16TT	IW16TT	IW16TT		4
SCIMITAR (68-90)												
2.8 GTC	99			01/80-12/85	IW20	5306	1.1	-	IW20TT	IW20TT		6
1300	51			01/85-12/87	Q20PR-U	3007	0.8	Q20TT	IQ20TT	IQ20TT		4
RENAULT												
4 (62-93)												
0.8	19/20	839.7.06		09/71-09/82	W20EPR-U	3047	0.8	W20TT	IW20TT	IW20TT		4
0.8 (1123)	19/21/25	800.705; 800.7.05; B1B.7.07; 800; B1B.7.07		10/62-06/86	W20EPR-U	3047	0.8	W20TT	IW20TT	IW20TT		4
0.8 (2106)	25	800.7.05; B1B.7.07		09/66-06/86	W20EPR-U	3047	0.8	W20TT	IW20TT	IW20TT		4
0.8 (2391)	21	800.7.05		04/83-06/86	W20EPR-U	3047	0.8	W20TT	IW20TT	IW20TT		4
1.0	25	C1C 708		08/90-01/92	W20EPR-U	3047	0.8	W20TT	IW20TT	IW20TT		4
1.0 (112C)	25	C1C 708		06/87-01/92	W20EPR-U	3047	0.8	W20TT	IW20TT	IW20TT		4
1.1	32	C1E 714		06/86-06/90	W16FP-U	4019	0.7	-	-	-		4
1.1	33	688 712		02/78-03/84	W20EPR-U	3047	0.8	W20TT	IW20TT	IW20TT		4
1.1 (1128, S128)	25	C1E 714		06/78-06/90	W16FP-U	4019	0.7	-	-	-		4
1.1 (1128, S128)	25	688.7.12; C1E.7.14; C1E.7.18, C1E.7.19		06/78-06/90	W20EPR-U	3047	0.8	W20TT	IW20TT	IW20TT		4
1.1 (2370, 210B)	25	C1E 714		10/76-07/89	W16FP-U	4019	0.7	-	-	-		4
1.1 (2370, 210B)	25	688.7.11; C1E.7.14; C1E.7.18		10/76-06/86	W20EPR-U	3047	0.8	W20TT	IW20TT	IW20TT		4
1.1 (239B)	26	C1E.7.18; C1E.7.19		07/82-05/89	W20EPR-U	3047	0.8	W20TT	IW20TT	IW20TT		4
5 (72-85)												
0.8 (1221, 1391)	27	800.7.02; 800.7.10		01/82-12/84	W20EPR-U	3047	0.8	W20TT	IW20TT	IW20TT		4
0.8 (1221, 1391, 1220)	26	800.7.02; 800.7.10; 839.7.01		10/72-08/84	W20EPR-U	3047	0.8	W20TT	IW20TT	IW20TT		4

	KW					Standard		Twin Tip		QTY	
RENAULT <i>continued</i>											
5 (72-85) <i>continued</i>											
0.8 (2381)	26	800 710		07/77-08/84	W20EPR-U	3047	0.8	W20TT	IW20TT	IW20TT	4
1.0 (1222, 1392)	32	689 710		01/72-12/85	W20EPR-U	3047	0.8	W20TT	IW20TT	IW20TT	4
1.0 (2382)	32	689 710		07/75-06/79	W20EPR-U	3047	0.8	W20TT	IW20TT	IW20TT	4
1.1	33	688.7.13		09/80-12/85	W20EPR-U	3047	0.8	W20TT	IW20TT	IW20TT	4
1.1 (1227, 1397)	33	688.7.13;C1E.7.26		09/80-12/85	W20EPR-U	3047	0.8	W20TT	IW20TT	IW20TT	4
1.3 (1224, 1394)	47	810.7.25		09/75-09/84	W20EPR-U	3047	0.8	W20TT	IW20TT	IW20TT	4
1.3 (1225)	31	810.7.29		09/76-09/79	W20EPR-U	3047	0.8	W20TT	IW20TT	IW20TT	4
1.3 (1225, 1395)	33	810.7.19;810.7.29		06/79-09/84	W20EPR-U	3047	0.8	W20TT	IW20TT	IW20TT	4
1.3 (2387)	32	810.7.26		03/76-08/82	W20EPR-U	3047	0.8	W20TT	IW20TT	IW20TT	4
1.3 Automatik (1225, 1395)	40	810.7.29		06/79-09/84	W20EPR-U	3047	0.8	W20TT	IW20TT	IW20TT	4
1.4	81	840.26;C6J.7.50		06/84-01/85	IT27	5329	0.8	-	-	-	4
1.4 (1229, 1399)	46	847.7.12;C2J.7.13		01/82-12/85	W20EPR-U	3047	0.8	W20TT	IW20TT	IW20TT	4
1.4 (1229, 1399)	46	847 725		01/82-12/85	W20EP-U	3043	0.8	W20TT	IW20TT	IW20TT	4
1.4 Alpine A5 (1223)	68	840.25		09/77-09/81	T20EPR-U	5032	0.8	T20TT	IT20TT	IT20TT	4
1.4 Alpine Turbo (122B)	79	840.26;C6J.7.28; C6J.7.50		10/81-01/85	IT27	5329	0.8	-	-	-	4
1.4 Automatik (1229, 1399)	43	847.7.12;C2J.7.13		06/82-09/84	W20EPR-U	3047	0.8	W20TT	IW20TT	IW20TT	4
6 (69-87)											
0.8	25	800.02		10/69-04/80	W20EPR-U	3047	0.8	W20TT	IW20TT	IW20TT	4
1.1	33/35	688.10		08/70-04/80	W20EPR-U	3047	0.8	W20TT	IW20TT	IW20TT	4
8 (62-72)											
1.1	33	688.01		11/62-10/72	W20EPR-U	3047	0.8	W20TT	IW20TT	IW20TT	4
9 (81-89)											
1.1 (L421)	35	C1E.7.15		09/81-05/87	W20EPR-U	3047	0.8	W20TT	IW20TT	IW20TT	4
1.2 (L42S)	40	C1G.7.00;C1G.7.10		09/85-12/88	W20EPR-U	3047	0.8	W20TT	IW20TT	IW20TT	4
1.4 (L422, L42C)	44	C1J.7.15;C2J.7.30		12/81-12/88	W20EPR-U	3047	0.8	W20TT	IW20TT	IW20TT	4
1.4 (L423)	53	C2J.7.17;C2J.7.56; C2J.7.66		09/81-12/85	W20EPR-U	3047	0.8	W20TT	IW20TT	IW20TT	4
1.4 (L423, L42R)	49	C2J.7.17;C2J.7.20; C2J.7.66, C2J.7.68, C2J.7.94, C2J.7.95, C2J.7.97		09/85-12/88	W20EPR-U	3047	0.8	W20TT	IW20TT	IW20TT	4
1.4 Automatik (L423)	50	C2J.7.17;C2J.7.18; C2J.7.57, C2J.7.67		09/81-12/85	W20EPR-U	3047	0.8	W20TT	IW20TT	IW20TT	4
1.4 Turbo	85	C1J.7.70		12/86-09/88	IW24	5316	0.7	-	-	-	4
1.4 Turbo (L425)	77	C1J.7.60;C1J.7.64		04/84-12/86	IW24	5316	0.7	-	-	-	4
1.6 D (L424)	40	F8M 700; F8M 720; F8M 730		10/82-12/88	DG-001		11V				4
1.7 (L426)	59	F2N.7.97		09/87-12/89	W20EPR-U	3047	0.8	W20TT	IW20TT	IW20TT	4
1.7 (L426)	59	F2N.7.00;F2N.7.04		09/84-12/89	W24EPR-U	4136	0.8	-	-	-	4
1.7 (L42E)	69	F3N 708		06/87-12/88	W22EP-U	3085	0.8	W22TT	-	VW22	4
1.7 (L42F)	54	F3N 718		10/86-12/88	W20EPR-U	3047	0.8	W20TT	IW20TT	IW20TT	4
1.7 (L42L)	55	F2N.7.30		10/86-12/88	W24EPR-U	4136	0.8	-	-	-	4
1.7 (L42N)	65	F2N 710		10/86-12/88	W22EP-U	3085	0.8	W22TT	-	VW22	4
10 (66-72)											
1.1	33	688.01		05/66-10/72	W20EPR-U	3047	0.8	W20TT	IW20TT	IW20TT	4
11 (83-88)											
1.1 (B/C371)	35	C1E 715		03/83-06/86	W20EPR-U	3047	0.8	W20TT	IW20TT	IW20TT	4
1.1 (S371)	35	C1E 715		03/83-06/86	W20EPR-U	3047	0.8	W20TT	IW20TT	IW20TT	4
1.2 (B/C37S)	40	C1G 700		10/84-12/88	W20EPR-U	3047	0.8	W20TT	IW20TT	IW20TT	4
1.2 (S37S)	40	C1G 700		10/84-12/88	W20EPR-U	3047	0.8	W20TT	IW20TT	IW20TT	4
1.4 (B/C372, B/C37C)	44	C1J 715		03/83-12/88	W16EPR-U	3021	0.8	W16TT	IW16TT	IW16TT	4
1.4 (B/C373)	50/53	C2J 717; C2J.7.17;C2J.7.18		03/83-12/85	W20EPR-U	3047	0.8	W20TT	IW20TT	IW20TT	4
1.4 (B/C373, B/C37R)	49	C2J 768		03/83-12/88	W20EPR-U	3047	0.8	W20TT	IW20TT	IW20TT	4
1.4 (S372)	44	C1J 715		03/83-09/86	W16EPR-U	3021	0.8	W16TT	IW16TT	IW16TT	4
1.4 (S373)	50	C2J 768		03/83-12/86	W20EPR-U	3047	0.8	W20TT	IW20TT	IW20TT	4
1.4 Turbo (B/C375)	77/85	C1J.7.60;C1J.7.64; C1J.7.70		04/84-12/88	IW24	5316	0.7	-	-	-	4
1.6 D (B/C374)	40	F8M 700; F8M 720; F8M 730		08/83-12/88	DG-001		11V				4
1.6 D (S374)	40	F8M 700; F8M 720; F8M 730		08/83-12/88	DG-001		11V				4
1.7 (B/C376)	59	F2N 704		10/83-12/87	W22EP-U	3085	0.8	W22TT	-	VW22	4
1.7 (B/C37D)	64	F2N 742		06/87-12/88	W22EP-U	3085	0.8	W22TT	-	VW22	4
1.7 (B/C37E)	69	F3N 708		06/87-12/88	W22EP-U	3085	0.8	W22TT	-	VW22	4
1.7 (B/C37F)	55	F3N 718		10/84-12/88	W20EPR-U	3047	0.8	W20TT	IW20TT	IW20TT	4
1.7 (B/C37L)	54	F2N.7.17;F2N.7.30		10/86-12/88	W20EPR-U	3047	0.8	W20TT	IW20TT	IW20TT	4

Spark & Glow Plugs









Application Tables

RENAULT <i>continued</i>	KW				Standard			Twin Tip			QTY
											
11 (83-88) <i>continued</i>											
1.7 (B/C37N)	65	F2N 708		10/86-12/88	W22EP-U	3085	0.8	W22TT	-	WV22	4
12 (69-80)											
1.3	37	810-02		07/75-04/80	W20EPR-U	3047	0.8	W20TT	IW20TT	IW20TT	4
1.3 (1170)	37	810-02		07/75-04/80	W20EPR-U	3047	0.8	W20TT	IW20TT	IW20TT	4
1.3 (1170)	40	810-02/97		08/75-07/77	W20EP-U	3043	0.8	W20TT	IW20TT	IW20TT	4
1.3 (1170)	40	810-02/97		10/70-08/80	W20FP-U	3068	0.7	WF20TT	-	-	4
1.3 (1177)	44	810.05; 810.06		08/73-08/80	W20FP-U	3068	0.7	WF20TT	-	-	4
1.3 TS (1177, 1337)	44	810-06		08/72-08/80	W20EPR-U	3047	0.8	W20TT	IW20TT	IW20TT	4
1.4	49	C1J 791		08/76-05/79	W20EP-U	3043	0.8	W20TT	IW20TT	IW20TT	4
1.6	50	821.10; 821.11		08/70-08/76	W20EP-U	3043	0.8	W20TT	IW20TT	IW20TT	4
1.6	75/83	821.20		08/70-08/76	W27ES-V	4047	0.6	-	-	-	4
1.6 Gordini (1173)	83	807.20; 821.20		08/70-12/74	W27ES-V	4047	0.6	-	-	-	4
14 (76-83)											
1.2 (1210)	42/43	129		05/76-12/83	T20EPR-U	5032	0.8	T20TT	IT20TT	IT20TT	4
1.4 (1212)	52	150		09/79-06/83	T20EPR-U	5032	0.8	T20TT	IT20TT	IT20TT	4
1.4 (1213)	44	X5J		12/81-12/83	T20EPR-U	5032	0.8	T20TT	IT20TT	IT20TT	4
16 (65-80)											
1.5	40			09/65-10/75	W16EPR-U	3021	0.8	W16TT	IW16TT	IW16TT	4
1.6 TA	52			01/69-08/80	W20EPR-U	3047	0.8	W20TT	IW20TT	IW20TT	4
1.6 TL	40	821		07/75-08/80	W20EPR-U	3047	0.8	W20TT	IW20TT	IW20TT	4
1.6 TL (1152, 1153, 1157)	48	821.02;821.03		01/71-08/80	W20EPR-U	3047	0.8	W20TT	IW20TT	IW20TT	4
1.6 TS (1151, 1154)	61	807; 807.04; 807.05		09/68-08/80	W20EPR-U	3047	0.8	W20TT	IW20TT	IW20TT	4
1.6 TX (1156)	68	843.01		06/74-08/80	W20EPR-U	3047	0.8	W20TT	IW20TT	IW20TT	4
17 (72-80)											
1.6 Gordini	79	843.13		09/75-10/80	W24EPR-U	4136	0.8	-	-	-	4
18 (78-93)											
1.4	47	847 720		05/79-07/86	W20EP-U	3043	0.8	W20TT	IW20TT	IW20TT	4
1.4 (1340)	47	847 720		04/78-07/86	W20EP-U	3043	0.8	W20TT	IW20TT	IW20TT	4
1.4 (1350)	47	847 720		05/79-07/86	W20EP-U	3043	0.8	W20TT	IW20TT	IW20TT	4
1.6	52	A2M.7.23		08/86-11/93	W20EPR-U	3047	0.8	W20TT	IW20TT	IW20TT	4
1.6 (1341)	58	A2M.7.23;A2M.7.95		04/78-09/82	W20EPR-U	3047	0.8	W20TT	IW20TT	IW20TT	4
1.6 (1341)	54	A2M 723		04/82-07/86	W20EP-U	3043	0.8	W20TT	IW20TT	IW20TT	4
1.6 (1351)	58	841.7.17;841.7.18; 841.7.26, A2M.7.95		05/79-09/82	W20EPR-U	3047	0.8	W20TT	IW20TT	IW20TT	4
1.6 (1351)	54	A2M 723		01/82-07/86	W20EP-U	3043	0.8	W20TT	IW20TT	IW20TT	4
1.6 4x4	54	A2M 723		01/83-07/86	W20EP-U	3043	0.8	W20TT	IW20TT	IW20TT	4
1.6 TS	71	A6M 725		05/82-07/86	W20EP-U	3043	0.8	W20TT	IW20TT	IW20TT	4
1.6 TS (1342)	71	A6M 725		05/82-07/86	W20EP-U	3043	0.8	W20TT	IW20TT	IW20TT	4
1.6 Turbo	92	A5L.7.17		10/82-07/86	IW24	5316	0.7	-	-	-	4
1.6 Turbo (1345)	80/92	A5L.7.17		10/80-07/86	IW24	5316	0.7	-	-	-	4
1.6 Turbo (1355)	80	A5L.7.17;A7L.7.52		09/82-07/86	IW24	5316	0.7	-	-	-	4
1.6 Turbo Inj.	82	A7L.7.52		09/82-07/86	IW24	5316	0.7	-	-	-	4
2.0 (1343)	77	J6R.7.11;J6R.7.14; J6R.7.15, J6R.7.16		05/82-07/86	T20EPR-U	5032	0.8	T20TT	IT20TT	IT20TT	4
2.0 (1353)	77	J6R.7.11;J6R.7.14; J6R.7.16		10/81-07/86	T20EPR-U	5032	0.8	T20TT	IT20TT	IT20TT	4
2.0 4x4	76	J6R.7.14;J6R.7.16		05/83-12/86	T20EPR-U	5032	0.8	T20TT	IT20TT	IT20TT	4
2.1 Diesel	49/53	852 710; J8S 711		11/81-07/86	DG-001		11V				4
2.1 Diesel (1344)	49	852 710; J8S 711		11/81-07/86	DG-001		11V				4
2.1 Diesel (1354)	49	852 710; J8S 711		11/80-07/86	DG-001		11V				4
2.1 TD	65	J8S 712		11/81-07/86	DG-001		11V				4
19 I (88-92)											
1.2	40	C1G 730		01/88-12/92	W16EP-U	3018	0.8	W16TT	IW16TT	IW16TT	4
1.4	55/ 57/ 59	E6J 700; E7J 700		01/88-12/92	Q20P-U	3125	0.8	Q20TT	IQ20TT	IQ20TT	4
1.4 (B/C532) CAT	43	C3J 710		01/89-04/92	W16EPR-U	3021	0.8	W16TT	IW16TT	IW16TT	4
1.4 (B/C53P)	43	C2J 772		01/89-12/89	W16EP-U	3018	0.8	W16TT	IW16TT	IW16TT	4
1.4 (L532, L53P)	43	C3J 710		07/88-04/92	W16EPR-U	3021	0.8	W16TT	IW16TT	IW16TT	4
1.7	55	F2N 724		07/91-04/92	W20EPR-U	3047	0.8	W20TT	IW20TT	IW20TT	4
1.7	70	F3N 742		07/91-04/92	W22EPR-U	3088	0.8	W22TT	-	WV22	4
1.7	68	F2N 720		09/88-04/92	W24EPR-U	4136	0.8	-	-	-	4
1.7 (B/C53B)	54	F3N 740		09/88-04/92	W20EPR-U	3047	0.8	W20TT	IW20TT	IW20TT	4
1.7 (B/C53C)	66	F3N 742		09/88-04/92	W22EPR-U	3088	0.8	W22TT	-	WV22	4
1.7 (L533)	68	F2N 720; F2N 721		09/88-12/92	W22EPR-U	3088	0.8	W22TT	-	WV22	4
1.7 (L53B)	54	F3N 740		10/89-04/92	W20EPR-U	3047	0.8	W20TT	IW20TT	IW20TT	4
1.7 (L53C)	66	F3N 742		07/88-04/92	W22EPR-U	3088	0.8	W22TT	-	WV22	4
1.7 (L53F)	79	F3N 746		08/88-12/92	W22EPR-U	3088	0.8	W22TT	-	WV22	4

	KW					Standard		Twin Tip		QTY	
RENAULT <i>continued</i>											
19 I (88-92) <i>continued</i>											
1.8 16V	101	F7P 700		06/89-08/90	PT16VR13	5068	1.3	TV16TT	ITV16TT	ITV16TT	4
1.8 16V (B/C53D)	99	F7P 704		06/89-04/92	K20PBR-S10	5061	1.0	K20TT	IK20TT	IK20TT	4
1.8 16V (D53D)	101	F7P 704		07/91-04/92	K20PBR-S10	5061	1.0	K20TT	IK20TT	IK20TT	4
1.8 16V (L53D)	99	F7P 704		10/89-04/92	K20PBR-S10	5061	1.0	K20TT	IK20TT	IK20TT	4
1.9 D	48	F8Q 706; F8Q 742		01/88-12/92	DG-001		11V				4
1.9 D (B/C534, B/C53J)	47	F8Q 706; F8Q 742		09/88-04/92	DG-001		11V				4
1.9 D (L534, L53J)	47	F8Q 706; F8Q 742		10/89-04/92	DG-001		11V				4
1.9 DT	68	F8Q.7.40		09/90-04/92	DG-012		11V				4
1.9 TD (L53K)	68	F8Q 740		09/90-04/92	DG-012		11V				4
19 II (92-01)											
1.2	44	E7F 730		05/92-09/94	Q16P-U11	3254	1.1	Q16TT	IQ16TT	IQ16TT	4
1.2	40	C1G 730		03/92-12/95	W16EP-U	3018	0.8	W16TT	IW16TT	IW16TT	4
1.4	59	E7J.7.00;E7J.7.07		10/94-11/95	K20PR-U	3145	0.8	K20TT	IK20TT	IK20TT	4
1.4	57/59	E6J 700		03/92-12/95	Q20P-U	3125	0.8	Q20TT	IQ20TT	IQ20TT	4
1.4	44	C1J.7.42		05/92-09/94	W14EPR-U	6011	0.8	-	IW16TT	IW16TT	4
1.4 (532)	43	C3J 710		04/92-12/95	W16EPR-U	3021	0.8	W16TT	IW16TT	IW16TT	4
1.4 (B/C532)	43	C3J 710		04/92-12/95	W16EPR-U	3021	0.8	W16TT	IW16TT	IW16TT	4
1.4 (B/C535)	55	E7J 742		01/92-12/95	Q20P-U	3125	0.8	Q20TT	IQ20TT	IQ20TT	4
1.4 (L535)	55	E7J 742		11/93-12/95	Q16P-U11	3254	1.1	Q16TT	IQ16TT	IQ16TT	4
1.7	55	F3N 740		05/92-11/95	W20EPR-U	3047	0.8	W20TT	IW20TT	IW20TT	4
1.7	79	F3N 746		05/92-09/94	W22EPR-U	3088	0.8	W22TT	-	VW22	4
1.7 (B/C53B)	54	F3N 740		04/92-12/95	W20EPR-U	3047	0.8	W20TT	IW20TT	IW20TT	4
1.7 (B/C53C)	66	F3N 743		04/92-12/95	W22EPR-U	3088	0.8	W22TT	-	VW22	4
1.7 (D53C)	66	F3N 742		04/92-09/93	W22EPR-U	3088	0.8	W22TT	-	VW22	4
1.7 (L533)	68	F2N 720		01/93-08/95	W22EP-U	3085	0.8	W22TT	-	VW22	4
1.7 (L53B)	54	F3N 740		04/92-12/95	W20EPR-U	3047	0.8	W20TT	IW20TT	IW20TT	4
1.7 (L53C)	66	F3N 742		04/92-12/95	W22EPR-U	3088	0.8	W22TT	-	VW22	4
1.8	79	F3P 700		05/92-11/95	W20EPR-U	3047	0.8	W20TT	IW20TT	IW20TT	4
1.8	67	F3P 765		05/92-09/94	W20EP-U	3043	0.8	W20TT	IW20TT	IW20TT	4
1.8 (453A/F)	66	F3P 760		04/92-09/94	W20EP-U	3043	0.8	W20TT	IW20TT	IW20TT	4
1.8 (5/353A)	66	F3P 760		04/92-09/94	IW20	5306	1.1	-	IW20TT	IW20TT	4
1.8 (5/353F, B/C538)	79	F3P 682		05/94-12/95	W20EPR-U	3047	0.8	W20TT	IW20TT	IW20TT	4
1.8 (853A)	66	F3P 760		09/93-06/96	IW20	5306	1.1	-	IW20TT	IW20TT	4
1.8 (B/C538)	81	F3P 700		04/92-05/94	W20EPR-U	3047	0.8	W20TT	IW20TT	IW20TT	4
1.8 (B/C53Y)	65	F3P 760		04/92-09/94	IW20	5306	1.1	-	IW20TT	IW20TT	4
1.8 (D53V, 853F, D53C)	79	F3P 682		07/94-06/96	W20EPR-U	3047	0.8	W20TT	IW20TT	IW20TT	4
1.8 (D53Y)	65	F3P.7.06;F3P.7.07		04/92-06/96	W20EPR-U	3047	0.8	W20TT	IW20TT	IW20TT	4
1.8 (L538)	81	F3P 700		04/92-05/94	W20EPR-U	3047	0.8	W20TT	IW20TT	IW20TT	4
1.8 (L53V, L538)	79	F3P 682		05/94-12/95	W20EPR-U	3047	0.8	W20TT	IW20TT	IW20TT	4
1.8 (L53Y)	65	F3P 704		04/92-12/95	W20EPR-U	3047	0.8	W20TT	IW20TT	IW20TT	4
1.8 16V	101	F7P 704		05/92-04/94	K20PBR-S10	5061	1.0	K20TT	IK20TT	IK20TT	4
1.8 16V (B/C53D)	99	F7P 704		04/92-12/95	K20PBR	5060	0.85	K20TT	IK20TT	IK20TT	4
1.8 16V (D53D)	99	F7P 704		04/92-06/96	K20PBR-S10	5061	1.0	K20TT	IK20TT	IK20TT	4
1.8 16V (L53D)	99	F7P 704		04/92-12/95	K20PBR	5060	0.85	K20TT	IK20TT	IK20TT	4
1.9 D	48	F8Q 706; F8Q 742		03/92-12/95	DG-001		11V				4
1.9 D	68	F8Q 744		05/92-11/95	DG-012		11V				4
1.9 D (B/C53J)	47	F8Q 742		04/92-12/95	DG-001		11V				4
1.9 D (L53J)	47	F8Q 742		04/92-12/95	DG-001		11V				4
1.9 dT	68	F8Q 740		03/92-12/95	DG-012		11V				4
1.9 dT (B/C53T)	66	F8Q 744		04/92-12/95	DG-012		11V				4
1.9 dT (L53T)	66	F8Q 744		04/92-12/95	DG-012		11V				4
20 (75-83)											
1.6 (1271)	66/71	843.20;843.21		10/75-12/81	W20EPR-U	3047	0.8	W20TT	IW20TT	IW20TT	4
2.0 (1272)	80	829.00;829.01		10/77-10/80	T20EPR-U	5032	0.8	T20TT	IT20TT	IT20TT	4
2.0 (1277)	76	829.02;829.03		10/80-12/83	T20EPR-U	5032	0.8	T20TT	IT20TT	IT20TT	4
2.1 Diesel (1276)	47	852		10/80-12/83	DG-001		11V				4
2.1 TD	63	J8S 702		01/82-12/83	DG-001		11V				4
2.2 (1279)	85	851.00;851.01		10/80-12/83	T20EPR-U	5032	0.8	T20TT	IT20TT	IT20TT	4
21 (86-95)											
1.4 (B48D)	51	C2J.7.70;C2L.7.17		09/89-04/92	W20EPR-U	3047	0.8	W20TT	IW20TT	IW20TT	4
1.4 (L48D)	51	C2J.7.17;C2J.7.70; C2L.7.14, C2L.7.17		06/88-10/93	W20EPR-U	3047	0.8	W20TT	IW20TT	IW20TT	4
1.7	55/65	F2N 710; F2N 712		06/86-04/95	W22EP-U	3085	0.8	W22TT	-	VW22	4
1.7	65	F2N.7.11;F2N.7.58		07/89-05/93	W24EPR-U	4136	0.8	-	-	-	4
1.7 (B48E)	66	F3N 722		09/89-06/94	W22EP-U	3085	0.8	W22TT	-	VW22	4
1.7 (B48F)	54	F3N 726		09/89-10/92	W20EPR-U	3047	0.8	W20TT	IW20TT	IW20TT	4
1.7 (K/S481)	55	F2N 712		06/86-03/93	W22EP-U	3085	0.8	W22TT	-	VW22	4











Spark & Glow Plugs







Application Tables







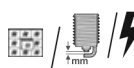

RENAULT <i>continued</i>	KW				Standard			Twin Tip			QTY
											
21 (86-95) <i>continued</i>											
1.7 (K/S482)	65	F2N 710		10/86-12/88	W22EP-U	3085	0.8	W22TT	-	VW22	4
1.7 (K48E)	66/69	F3N 722		06/86-12/93	W22EP-U	3085	0.8	W22TT	-	VW22	4
1.7 (K48F) CAT	54	F3N 726		09/89-06/93	W20EPR-U	3047	0.8	W20TT	IW20TT	IW20TT	4
1.7 (K48M)	54	F2N 750		06/86-12/89	W22EP-U	3085	0.8	W22TT	-	VW22	4
1.7 (K48N)	64	F2N 752		06/87-04/89	W24EPR-U	4136	0.8	-	-	-	4
1.7 (L481)	55	F2N 712		03/86-12/87	W22EP-U	3085	0.8	W22TT	-	VW22	4
1.7 (L482)	65	F2N 710		03/86-03/93	W22EP-U	3085	0.8	W22TT	-	VW22	4
1.7 (L48E)	66/69	F3N 722		03/86-02/94	W22EP-U	3085	0.8	W22TT	-	VW22	4
1.7 (L48M, L48F)	54	F2N 750		07/86-02/94	W22EP-U	3085	0.8	W22TT	-	VW22	4
1.7 (L48N)	64	F2N 752		06/87-04/89	W20EPR-U	3047	0.8	W20TT	IW20TT	IW20TT	4
1.9 D	47	F8Q 710		03/86-08/94	DG-001		11V				4
1.9 D (B48H, B48I)	47	F8Q 710		09/89-01/94	DG-001		11V				4
1.9 D (L48H, L48I)	47	F8Q 710		08/89-10/93	DG-001		11V				4
2.0	78	J6R 758		05/91-10/93	T20EP-U	5031	0.8	T20TT	IT20TT	IT20TT	4
2.0	75/86	J6R 758; J6R 759; J6R 792; J7R 750; J7R.7.50; J7R.7.51		04/86-05/93	T22EP-U	5040	0.8	-	-	-	4
2.0 (B48C)	88	J7R 746		09/89-12/93	T20EP-U	5031	0.8	T20TT	IT20TT	IT20TT	4
2.0 (B48R/Y)	99	J7R 740		02/90-10/92	K20PBR	5060	0.85	K20TT	IK20TT	IK20TT	4
2.0 (K483)	85	J7R 750		06/86-12/88	T22EP-U	5040	0.8	-	-	-	4
2.0 (K48C)	88	J7R 746		03/86-12/93	T20EP-U	5031	0.8	T20TT	IT20TT	IT20TT	4
2.0 (K48R)	99	J7R 740		06/90-02/94	K20PBR	5060	0.85	K20TT	IK20TT	IK20TT	4
2.0 (L483)	85	J7R 750		03/86-12/88	T22EP-U	5040	0.8	-	-	-	4
2.0 (L489)	75	J6R 758		03/86-10/93	T22EP-U	5040	0.8	-	-	-	4
2.0 (L48C)	88	J7R 746		03/86-12/93	T20EP-U	5031	0.8	T20TT	IT20TT	IT20TT	4
2.0 (L48R)	99	J7R 740		02/90-06/94	K20PBR	5060	0.85	K20TT	IK20TT	IK20TT	4
2.0 4x4	88	J7R 746		03/89-12/93	T20EP-U	5031	0.8	T20TT	IT20TT	IT20TT	4
2.0 4x4 (B48R/Y)	99	J7R 740		09/90-10/92	K20PBR	5060	0.85	K20TT	IK20TT	IK20TT	4
2.0 4x4 (L48R)	99	J7R 740		12/89-02/94	K20PBR	5060	0.85	K20TT	IK20TT	IK20TT	4
2.0 Turbo (L485)	129	J7R 752		04/87-03/90	T22EP-U	5040	0.8	-	-	-	4
2.0 Turbo (L48L)	119	J7R 756		02/90-10/92	IT22	5327	0.8	-	-	-	4
2.0 Turbo 4x4	129	J7R 752		08/89-10/93	T22EP-U	5040	0.8	-	-	-	4
2.0 Turbo 4x4 (L48L)	119	J7R 756		02/90-10/92	IT22	5327	0.8	-	-	-	4
2.0 TXi	100	J7R 740		07/89-05/93	K20PBR	5060	0.85	K20TT	IK20TT	IK20TT	4
2.1 D	49/50	J8S 704		06/86-08/94	DG-001		11V				4
2.1 D (B480)	51	J8S 784		04/92-06/94	DG-001		11V				4
2.1 D (B48V/B48O)	53	J8S 600; J8S 740		09/89-12/92	DG-001		11V				4
2.1 D (K/S486)	48	J8S 704		10/86-09/90	DG-001		11V				4
2.1 D (K/S48V, K/S48O)	53	J8S 600; J8S 740		08/89-12/92	DG-001		11V				4
2.1 D (K480)	51	J8S 784		02/92-09/95	DG-001		11V				4
2.1 D (L480)	51	J8S 784		10/92-06/94	DG-001		11V				4
2.1 D (L486)	48	J8S 704		03/86-12/89	DG-001		11V				4
2.1 D (L48V, L48O)	53	J8S 600; J8S 740		05/89-06/94	DG-001		11V				4
2.1 D 4x4 (K486)	48	J8S 704		10/88-05/92	DG-001		11V				4
2.1 TD	50	J8S 704		04/86-06/89	DG-001		11V				4
2.1 Turbo-D (B486, B488, B48V)	65	J8S 714; J8S 786; J8S 788		09/89-06/94	DG-001		11V				4
2.1 Turbo-D (K48A, K48W, K487, K488)	65	J8S 714; J8S 786; J8S 788		10/86-11/93	DG-001		11V				4
2.1 Turbo-D (L48A, L48W, L487, L488)	65	J8S 714; J8S 786; J8S 788		03/86-06/94	DG-001		11V				4
2.2	81	J7T 755		04/86-05/93	T22EP-U	5040	0.8	-	-	-	4
2.2 (B48K)	79	J7T 755		09/89-06/94	T22EP-U	5040	0.8	-	-	-	4
2.2 (K48K)	79	J7R.7.50; J7R.7.51		06/86-06/89	T22EP-U	5040	0.8	-	-	-	4
2.2 (L48K)	79	J7R.7.50; J7R.7.51		07/86-06/89	T22EP-U	5040	0.8	-	-	-	4
2.2 4x4 (K48K)	79	J7T 754; J7T 755		06/86-12/93	T22EP-U	5040	0.8	-	-	-	4
25 (84-93)											
2.0	88	J7R 722		03/87-12/93	T22EP-U	5040	0.8	-	-	-	4
2.0 (B297)	74	J6R 706; J6R 707; J6R 760; J6R 762; J6R 763		04/84-12/92	T20EPR-U	5032	0.8	T20TT	IT20TT	IT20TT	4
2.0 12V	103	J7R 721		06/88-12/93	K20PBR	5060	0.85	K20TT	IK20TT	IK20TT	4
2.0 12V (B294)	99	J7R 726		06/89-12/92	K20PBR	5060	0.85	K20TT	IK20TT	IK20TT	4
2.1 Diesel (B296)	46/51	J8S 706; J8S 736		04/84-12/92	DG-001		11V				4
2.1 Turbo-D FWD (B290, B29W)	63	J8S 708; J8S 738		04/84-12/92	DG-001		11V				4
2.2 (B29)	76	J7T.7.08		11/85-08/86	T20EPR-U	5032	0.8	T20TT	IT20TT	IT20TT	4
2.2 (B29)	76	J7T.7.32		06/87-03/89	T22EP-U	5040	0.8	-	-	-	4
2.2 (B29B)	79	J7T 732		09/86-12/92	T22EP-U	5040	0.8	-	-	-	4

Spark & Glow Plugs

Application Tables







	KW										QTY
RENAULT <i>continued</i>											
25 (84-93) <i>continued</i>											
2.2 (B29E)	89/91	J7T 706; J7T 731		04/84-12/89	T22EP-U	5040	0.8	-	-	-	4
2.4 V6 Turbo (B295)	133	Z7U 702		10/84-05/90	T22EP-U	5040	0.8	-	-	-	6
2.5 V6 Turbo (B29G)	151	Z7U 700		01/90-12/92	T22EP-U	5040	0.8	-	-	-	6
2.7 V6 Injection (B298)	104	Z7V 708; Z7V 709; Z7V 711		04/84-08/89	T20EPR-U	5032	0.8	T20TT	IT20TT	IT20TT	6
2.8 V6 (B293)	115	Z7W 700		06/87-02/90	T22EP-U	5040	0.8	-	-	-	6
2.8 V6 Injection (B29F)	110	Z7W 706; Z7W 707; Z7W 709		06/87-12/92	T22EP-U	5040	0.8	-	-	-	6
30 (75-86)											
2.1 Turbo-D (1270)	63	J8S 702		02/82-03/86	DG-001		11V				4
2.6 TS (1275)	94	144		07/78-01/82	T20EPR-U	5032	0.8	T20TT	IT20TT	IT20TT	6
2.6 TX (1278)	105	140		10/78-12/83	T20EPR-U	5032	0.8	T20TT	IT20TT	IT20TT	6
AVANTIME (01-03)											
2.0 16V Turbo (DE0U, DE0V)	120	F4R.7.60;F4R.7.61		11/01-05/03	PK20PR-P8	3245	0.8	-	IK20TT	IK20TT	4
2.2 dCi (DE01)	110	G9T 712		05/02-05/03	DG-126		11V				4
3.0 V6 (DE04, DE0T)	152	L7X.7.21		09/01-05/03	IKH16	5343	1.1	-	IKH16TT	IKH16TT	6
3.0 V6 (DE04, DE0T)	152	L7X.7.20		09/01-05/03	PK20PR-L11	3142	1.1	-	IK20TT	IK20TT	6
CAPTUR (13-)											
1.5 dCi 90	66			06/13-	DG-609		4.4V				4
CLIO I (90-98)											
1.1	36	C1E.7.00		04/92-08/92	W14EPR-U	6011	0.8	-	IW16TT	IW16TT	4
1.1	34	C1E 700		01/91-09/98	W16EPR-U	3021	0.8	W16TT	IW16TT	IW16TT	4
1.2	40	E7F 706		01/91-09/98	Q16PR-U	3137	0.8	Q16TT	IQ16TT	IQ16TT	4
1.2	44	E7F.7.00;E7F.7.04		01/91-02/96	Q16R-U	3129	0.8	Q16TT	IQ16TT	IQ16TT	4
1.2	40	C3G 720		06/94-02/98	W16EPR-U	3021	0.8	W16TT	IW16TT	IW16TT	4
1.2 (5/357Y, 5/357K)	40/43	D7F 730		01/96-09/98	Q16PR-U	3137	0.8	Q16TT	IQ16TT	IQ16TT	4
1.2 (B/C/S572)	44	E5F 710		05/90-03/96	Q16PR-U	3137	0.8	Q16TT	IQ16TT	IQ16TT	4
1.2 (B/C/S577)	40	C3G 720		01/96-12/96	W16EPR-U	3021	0.8	W16TT	IW16TT	IW16TT	4
1.2 (B/C/S57A, B/C57S, 5/357F, 5/357J, 5/357L, 5/357R)	43	E7F 700		05/90-09/98	Q16PR-U	3137	0.8	Q16TT	IQ16TT	IQ16TT	4
1.2 (B/C57R)	40	E7F 706		01/91-06/96	Q16PR-U	3137	0.8	Q16TT	IQ16TT	IQ16TT	4
1.4	57	E6J 712; E6J 713; E6J 760		05/90-02/98	K20PR-U	3145	0.8	K20TT	IK20TT	IK20TT	4
1.4	59	E7J 710		01/91-09/98	Q16PR-U	3137	0.8	Q16TT	IQ16TT	IQ16TT	4
1.4 (B/C57T, B/C57Y)	58	E7J 718		01/91-09/98	Q16PR-U	3137	0.8	Q16TT	IQ16TT	IQ16TT	4
1.4 (B57J, C57J)	55	E7J 757		01/91-09/98	Q16PR-U	3137	0.8	Q16TT	IQ16TT	IQ16TT	4
1.7 (B/C574)	68	F2N 770		01/91-12/93	W22EPR-U	3088	0.8	W22TT	-	VW22	4
1.8	70	F3P 710		01/91-09/98	W20EPR-U	3047	0.8	W20TT	IW20TT	IW20TT	4
1.8 (B/C578)	66	F3P 754		08/94-09/98	W20EP-U	3043	0.8	W20TT	IW20TT	IW20TT	4
1.8 (B/C57C, B/C57U)	65	F3P 710		01/91-09/98	W20EPR-U	3047	0.8	W20TT	IW20TT	IW20TT	4
1.8 16V (C57D)	99	F7P 722		01/91-03/96	K20PBR-S10	5061	1.0	K20TT	IK20TT	IK20TT	4
1.8 Rsi (B/C579)	80	F3P 712		01/93-08/95	W20EPR-U	3047	0.8	W20TT	IW20TT	IW20TT	4
1.8 Rsi (B/C57H)	79	F3P 758		08/95-09/98	W22EP-U	3085	0.8	W22TT	-	VW22	4
1.9 D	48	F8Q 730		01/91-09/98	DG-001		11V				4
1.9 D	48	F8Q 676		05/96-02/98	DG-009		11V				4
1.9 D (B/C/S576, B/C/S57L)	47	F8Q 730; F8Q 732		01/91-09/98	DG-001		11V				4
1.9 D	40	F8Q 678		01/97-09/98	DG-001		11V				4
Williams (B/C57M)	108	F7R 700		01/94-09/98	K20BR-S10	3330	1.0	K20TT	IK20TT	IK20TT	4
CLIO II (98-)											
1.0	52	D4D.7.00;D4D.7.06; D4D.752		06/01-04/05	XE20HR-U9	3427	0.9	-	IXEH20TT	IXEH20TT	4
1.1 (SB0A, SB0F, SB1K, SB2D)	43	D7F 722		09/98-	K20TXR	5063	1.0	K20TT	IK20TT	IK20TT	4
1.2	55			06/01-	XE20HR-U9	3427	0.9	-	IXEH20TT	IXEH20TT	4
1.2 (BB0A, BB0F, BB10, BB1K, BB28, BB2D, BB2H, CB0A...)	43	D7F 720; D7F 726; D7F 746; D7F 764; D7F 766		09/98-	K20TXR	5063	1.0	K20TT	IK20TT	IK20TT	4
1.2 (BB0A, CB0A)	44	D7F 722		03/99-05/01	K20TXR	5063	1.0	K20TT	IK20TT	IK20TT	4
1.2 (SB0A, SB0F, SB10)	44	D7F 726		03/99-10/03	K20TXR	5063	1.0	K20TT	IK20TT	IK20TT	4
1.2 16V	54	D4F 706; D4F 712		06/06-	XE20HR-U9	3427	0.9	-	IXEH20TT	IXEH20TT	4
1.2 16V (BB05, BB0W, BB11, BB27, BB2T, BB2U, BB2V, CB05...)	55	D4F 712		06/01-	XE20HR-U9	3427	0.9	-	IXEH20TT	IXEH20TT	4
1.2 LPG	43	D7F 764; D7F 766		09/98-10/07	K20TXR	5063	1.0	K20TT	IK20TT	IK20TT	4
1.4 (B/CB0C)	55	E7J 634; E7J 780; K7J 700		09/98-05/05	K20TXR	5063	1.0	K20TT	IK20TT	IK20TT	4
1.4 16V (B/CB0L)	70	K4J 712; K4J 713		10/99-09/04	K20TXR	5063	1.0	K20TT	IK20TT	IK20TT	4
1.4 16V (B/CB0P)	72	K4J 710		08/00-	K20PR-U	3145	0.8	K20TT	IK20TT	IK20TT	4

	KW								QTY
RENAULT <i>continued</i>									
CLIO II (98-) <i>continued</i>									
1.5 dCi	50/59/60/74	K9K 702; K9K 712; K9K 714; K9K 716		01/04-	DG-005	11V			4
1.5 dCi (B/C2J)	50	K9K 700; K9K 714		08/04-	DG-005	11V			4
1.5 dCi (B/CB03)	59	K9K 702		06/01-10/03	DG-005	11V			4
1.5 dCi (B/CB07)	48	K9K 700; K9K 704		06/01-	DG-005	11V			4
1.5 dCi (B/CB08)	60	K9K 702		06/01-	DG-005	11V			4
1.5 dCi (B/CB3M)	47	K9K 740		06/05-	DG-005	11V			4
1.5 dCi (B/CB3N)	62	K9K 718		02/07-	DG-005	11V			4
1.5 dCi (SB07)	48	K9K 700; K9K 704		06/01-	DG-005	11V			4
1.6 (B/CB0D)	66	K7M 744; K7M 745		09/98-05/05	K20TXR	5063 1.0	K20TT	IK20TT	4
1.6 16V (BB01, BB0H, BB0T, BB14, BB1D, BB1R, BB2KL...)	79	K4M 708; K4M 740; K4M 742; K4M 743; K4M 744; K4M 745; K4M 748		09/98-	K20TXR	5063 1.0	K20TT	IK20TT	4
1.9 D (B/CB0E)	47	F8Q.630		09/98-05/05	DG-008	11V			4
1.9 D (B/CB0J)	48	F8Q 632		02/00-05/01	DG-112	11V			4
1.9 D (SB0E)	47	F8Q.630		09/98-05/05	DG-008	11V			4
1.9 D (SB0J)	48	F8Q 632		02/00-05/01	DG-112	11V			4
1.9 dTi (B/CB0U)	59	F9Q 780		12/99-05/05	DG-005	11V			4
1.9 DTi (SB0U)	59	F9Q 780		02/00-05/01	DG-005	11V			4
2.0 16V Sport	132	F4R 738		01/04-	PK20PR11	3168 1.1	K20TT	IK20TT	4
2.0 16V Sport (CB0M)	124	F4R 730; F4R 736		02/00-	PK20PR11	3168 1.1	K20TT	IK20TT	4
3.0 V6 Sport (CB1A)	166	L7X 760		11/00-12/02	IKH20	5344 1.1	-	IKH20TT	6
3.0 V6 Sport (CB1H, CB1U, CB2S)	187	L7X 762		12/02-05/05	IKH20	5344 1.1	-	IKH20TT	6
CLIO III (05-)									
1.2 (BR01, BR03, BR0E, CR0E)	57	D4F 764		10/05-	XE20HR-U9	3427 0.9	-	IXEH20TT	4
1.2 16V	58	D4F 764		06/05-04/09	XE20HR-U9	3427 0.9	-	IXEH20TT	4
1.2 16V Hi-Flex (BR1U, CR1U)	55	D4F 740; D4F 742	Flexible fuel	07/08-	XE20HR-U9	3427 0.9	-	IXEH20TT	4
1.2 16V Hi-Flex (KR0S)	55	D4F 740		07/08-04/09	XE20HR-U9	3427 0.9	-	IXEH20TT	4
1.2 16V (BR02, BR0J, BR11, CR02, CR0J, CR11)	55	D4F 740		06/05-	XE20HR-U9	3427 0.9	-	IXEH20TT	4
1.2 16V (BR0R, BR1D, BR1L, CR0R)	48	D4F 740		06/05-04/09	XE20HR-U9	3427 0.9	-	IXEH20TT	4
1.2 16V (KR02, KR0J)	55	D4F 740		02/08-	XE20HR-U9	3427 0.9	-	IXEH20TT	4
1.2 16V (KR0E)	58	D4F 764		02/08-04/09	XE20HR-U9	3427 0.9	-	IXEH20TT	4
1.2 Ethanol	55			07/08-	XE20HR-U9	3427 0.9	-	IXEH20TT	4
1.4 16V	72	K4J 780		06/05-	K20PR-U	3145 0.8	K20TT	IK20TT	4
1.5 dCi	47/48/60	K9K 750; K9K 752		06/05-	DG-005	11V			4
1.5 dCi	55/65	K9K 770; K9K 772		08/10-	DG-609	4.4V			4
1.5 dCi (BR0H, CR0H)	78	K9K 764; K9K 774		06/05-	DG-005	11V			4
1.5 dCi (BR17, CR17)	63	K9K 766		06/05-	DG-005	11V			4
1.5 dCi (BR1C, CR1C)	76	K9K 772		06/05-04/09	DG-005	11V			4
1.5 dCi (C/BR0G, C/BR1G)	50	K9K 714; K9K 768		06/05-	DG-005	11V			4
1.5 dCi (KR0F)	63	K9K 766		02/08-	DG-005	11V			4
1.5 dCi (KR0G)	50	K9K 714; K9K 768		02/08-	DG-005	11V			4
1.5 dCi (KR0H)	78	K9K 764; K9K 774		02/08-	DG-005	11V			4
1.5 dCi (KR1C, KR1N)	76	K9K 772		02/08-04/09	DG-005	11V			4
1.6 16V (BR05, BR0B, BR0Y, BR15, BR1J, BR1M, BR1Y, CR0B...)	82	K4M 800; K4M 801		06/05-	K20PR-U	3145 0.8	K20TT	IK20TT	4
1.6 16V (BR09, BR0T, CR09, CR0T)	65	K4M 804		06/05-04/09	K20PR-U	3145 0.8	K20TT	IK20TT	4
1.6 16V (KR0B)	82	K4M 800; K4M 801		02/08-	K20PR-U	3145 0.8	K20TT	IK20TT	4
1.6 16V (KR10)	94	K4M 862		11/08-	VK22	5610 0.8	-	VK22	4
1.6 16V GT (BR10, CR10)	94	K4M 862		06/09-	VK22	5610 0.8	-	VK22	4
2.0 16V (BR0C, BR0K, CR0C, CR0K)	102	M4R 700; M4R 701		09/06-	FXE20HR11	3439 1.1	-	IXEH20TT	4
2.0 16V Sport	145/148	F4R 830		02/06-	VK22	5610 0.8	-	VK22	4
CLIO IV (12-)									
1.2 16V	54	D4F 740		11/12-	XE20HR-U9	3427 0.9	-	IXEH20TT	4
1.5 dCi 75	55	K9K 612		11/12-	DG-609	4.4V			4
1.5 dCi 90	66	K9K 608		11/12-	DG-609	4.4V			4
DUSTER (09-)									
1.5 dCi	66	K9K 884		06/09-	DG-609	4.4V			4

	KW					Standard				QTY	
RENAULT <i>continued</i>											
DUSTER (09-) <i>continued</i>											
1.6 16V (HSAT)	75	K4M 616		02/12-	K20PR-U	3145	0.8	K20TT	IK20TT	IK20TT	4
2.0	98	F4R.4.00		02/12-	K20PR-U	3145	0.8	K20TT	IK20TT	IK20TT	4
ESPACE I (84-92)											
2.0 (J/S112)	74/80	J6R 234; J6R 734		07/84-12/90	T20EP-U	5031	0.8	T20TT	IT20TT	IT20TT	4
2.0 i (J116)	87	J7R 760		01/89-12/90	T22EP-U	5040	0.8	-	-	-	4
2.0 i Quadra (J116)	87	J7R 760		03/88-12/92	T22EP-U	5040	0.8	-	-	-	4
2.1 TD (J/S115)	65	J8S 240; J8S 774		10/84-12/90	DG-001		11V				4
2.2 (J117)	79	J7T 770		07/86-12/90	T22EP-U	5040	0.8	-	-	-	4
2.2 Quadra (J117)	79	J7T 770		01/88-12/90	T22EP-U	5040	0.8	-	-	-	4
ESPACE II (91-96)											
2.0 (J636)	76	J7R 768		01/91-10/96	T20EP-U	5031	0.8	T20TT	IT20TT	IT20TT	4
2.1 RTDT Quadra	65	J8S 772		01/91-05/92	DG-001		11V				4
2.1 TD (J633, J634, J/S635, J/S63D)	65	J8S 610; J8S 772; J8S 776; J8S 778		01/91-10/96	DG-001		11V				4
2.1 TD (J63E)	66	J8S 612		11/94-10/96	DG-001		11V				4
2.2 (J/S637, J63G)	79	J7T 772		01/91-10/96	T22EP-U	5040	0.8	-	-	-	4
2.2 4x4 (J/S637, J63G)	79	J7T 772; J7T 773		03/91-12/96	T22EP-U	5040	0.8	-	-	-	4
2.8 V6 (J638, J63J)	110	Z7W 712; Z7W 713; Z7W 717		01/91-10/96	T22EP-U	5040	0.8	-	-	-	6
ESPACE III (96-02)											
1.9 dTi (JE0M)	72	F9Q 722		02/99-10/02	DG-005		11V				4
2.0	102	F4R.7.00;F4R.7.01		09/01-10/02	K20PR-U	3145	0.8	K20TT	IK20TT	IK20TT	4
2.0 (JE0A)	84	F3R 728		11/96-10/00	W16EPR-U	3021	0.8	W16TT	IW16TT	IW16TT	4
2.0 16V (JE0N, JE0L, JE02)	103	F4R.7.00;F4R.7.01		10/98-10/02	K20PR-U	3145	0.8	K20TT	IK20TT	IK20TT	4
2.2 12V TD (JE0E, JE0H, JE0P)	83	G8T 714; G8T 716; G8T 760		11/96-10/00	DG-101		11V				4
2.2 D	84	G8T 716		11/97-01/00	DG-101		11V				4
2.2 dCi (JE0K)	95	G9T 642; G9T 710		10/00-10/02	DG-126		11V				4
2.2 dCi (JE0S)	85	G9T 710		07/00-10/02	DG-126		11V				4
3.0 (JE0D)	123	Z7X 775		11/96-10/98	K20TXR	5063	1.0	K20TT	IK20TT	IK20TT	6
3.0 V6 24V (JE0G, JE0R)	140	L7X 727		10/98-10/02	PK20PR11	3168	1.1	K20TT	IK20TT	IK20TT	6
ESPACE IV (02-)											
1.9 dCi (JK0U)	85	F9Q 820		04/03-02/05	DG-005		11V				4
1.9 dCi (JK0U, JK0G)	88	F9Q 680; F9Q 820; F9Q 826		11/02-	DG-005		11V				4
2.0 (JK09)	100	F4R.7.90;F4R.7.91; F4R.7.92		11/02-	PK20PR-P8	3245	0.8	-	IK20TT	IK20TT	4
2.0 (JK0N, JK0A, JK1D)	125	F4R.7.96;F4R.7.97		04/05-	PK20PR-P8	3245	0.8	-	IK20TT	IK20TT	4
2.0 Turbo (JK0B, JK0A, JK0N)	120	F4R.7.94;F4R.7.95		11/02-02/06	PK20PR-P8	3245	0.8	-	IK20TT	IK20TT	4
2.2 dCi (JK07)	102	G9T 645		02/06-	DG-126		11V				4
2.2 dCi (JK0H)	110	G9T 742; G9T 743		11/02-	DG-126		11V				4
3.0 dCi (JK0E, JK0Y)	133	P9X 715		01/06-	DG-312		11V				6
3.0 dCi (JK0J, JK0V)	130	P9X 701		11/02-	DG-312		11V				6
3.5 V6 (JK00, JK0F, JK0P, JK0S, JK0W)	177	V4Y 711; V4Y 715		11/02-	VKH16	5617	1.1	-	IKH16TT	IKH16TT	6
ESTAFETTE (62-81)											
1.1	29	688.01		02/62-12/81	W20EPR-U	3047	0.8	W20TT	IW20TT	IW20TT	4
1.3	29	810.01		08/69-01/80	W20EPR-U	3047	0.8	W20TT	IW20TT	IW20TT	4
EXPRESS (95-99)											
1.9 D	40/47	F8Q 640; F8Q 724; F8Q 776		07/95-10/99	DG-001		11V				4
FLUENCE (10-)											
1.5 dCi	70	K9K 826		07/14-	DG-609		4.4V				4
1.5 dCi (L30A)	63	K9K 830		02/10-	DG-609		4.4V				4
1.5 dCi (L30B)	78	K9K 832		02/10-	DG-609		4.4V				4
1.5 dCi (L30D, L30L)	81	K9K 836; K9K 837		02/10-	DG-609		4.4V				4
1.5 dCi (L30S)	66	K9K 834		02/10-	DG-609		4.4V				4
1.6 16V (L301, L30F, L30P, L30R)	81	K4M 838; K4M 839		02/10-	K20PR-U	3145	0.8	K20TT	IK20TT	IK20TT	4
2.0 16V (L30C, L30G, L30T, L30V)	103	M4R 714; M4R 751		02/10-	FXE20HR11	3439	1.1	-	IXEH20TT	IXEH20TT	4
FUEGO (80-85)											
1.4 TL/GTL	47	847.7.20		02/80-10/85	W14EPR-U	6011	0.8	-	IW16TT	IW16TT	4
1.4 TL/GTL	47	847 720		02/80-10/85	W20EP-U	3043	0.8	W20TT	IW20TT	IW20TT	4
1.6	52	A2M 723		04/83-10/85	W20EP-U	3043	0.8	W20TT	IW20TT	IW20TT	4
1.6 TS/GTS (1362)	71	A6M 725		10/80-10/85	W20EP-U	3043	0.8	W20TT	IW20TT	IW20TT	4
1.6 TS/GTS (1362)	71	A6M.1.25;A6M.7.25; A6M.7.26		10/80-10/85	W24EPR-U	4136	0.8	-	-	-	4
1.6 Turbo (1365)	97	A5L.7.50;A7L.23		08/83-10/85	IW24	5316	0.7	-	-	-	4







Spark & Glow Plugs







Application Tables





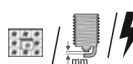

	KW					Standard		Twin Tip		QTY	
RENAULT <i>continued</i>											
FUEGO (80-85) <i>continued</i>											
2.0 TX/GTX (1363)	81	829 710		10/80-10/85	T20EPR-U	5032	0.8	T20TT	IT20TT	IT20TT	4
2.1 TD	65	J8S 712		08/82-10/85	DG-001		11V				4
GRAND SCÉNIC II (04-)											
1.5 dCi	60/76	K9K 722; K9K 734		04/04-	DG-005		11V				4
1.5 dCi (JM02, JM13)	74	K9K 728		04/04-	DG-005		11V				4
1.5 dCi (JM1E)	78	K9K 732		05/05-	DG-005		11V				4
1.6	83	K4M.7.82;K4M.8.12		04/04-07/08	K20PR-U	3145	0.8	K20TT	IK20TT	IK20TT	4
1.9 dCi	85			05/05-01/09	DG-005		11V				4
1.9 dCi (JM0G, JM12, JM1G, JM2C)	88	F9Q 812		04/04-	DG-005		11V				4
1.9 dCi (JM14)	96	F9Q 816; F9Q 818; F9Q EE 804; F9Q J 803		05/05-	DG-005		11V				4
1.9 dCi (JM15)	81	F9Q E 804		05/05-	DG-005		11V				4
2.0	99/120	F4R 770; F4R 771; F4R 776		04/04-04/09	K20PR-U	3145	0.8	K20TT	IK20TT	IK20TT	4
GRAND SCÉNIC III (09-)											
1.5 dCi	63/70/78/81	K9K 830; K9K 832; K9K 836; K9K 837; K9K 846		04/09-	DG-609		4.4V				4
1.6 16V (JZ0U)	81	K4M 858		02/09-	K20PR-U	3145	0.8	K20TT	IK20TT	IK20TT	4
1.9 dCi	96	F9Q 870; F9Q 872		02/09-	DG-619		4.4V				4
2.0 16V (JZ0G)	103	M4R 711		02/09-	FXE20HR11	3439	1.1	-	IXEH20TT	IXEH20TT	4
KANGOO (97-)											
1.2 (FC01, FC0A, FC0F)	43	D7F 710; D7F 720; D7F 722; D7F 726; D7F 744; D7F 746		08/97-	K20TXR	5063	1.0	K20TT	IK20TT	IK20TT	4
1.2 (FC1A)	44	D7F 764; D7F 766		07/98-07/01	K20TXR	5063	1.0	K20TT	IK20TT	IK20TT	4
1.2 (KC0A, KC0K, KC0F, KC01)	43	D7F 710; D7F 720; D7F 722; D7F 726; D7F 744; D7F 746		08/97-	K20TXR	5063	1.0	K20TT	IK20TT	IK20TT	4
1.2 16V (FC05)	55	D4F 712		10/01-	XE20HR-U9	3427	0.9	-	IXEH20TT	IXEH20TT	4
1.2 16V (KC03, KC05, KC06, KC0T, KC0W, KC1D)	55	D4F 712		06/01-	XE20HR-U9	3427	0.9	-	IXEH20TT	IXEH20TT	4
1.2 BiFuel	43	D7F 710; D7F 744		07/98-07/01	XE20HR-U9	3427	0.9	-	IXEH20TT	IXEH20TT	4
1.4 (FC0C, FC0B, FC0H, FC0M)	55	E7J 634		08/97-	K20PR-U	3145	0.8	K20TT	IK20TT	IK20TT	4
1.4 (KC0C, KC0H, KC0B, KC0M)	55	K7J 700		08/97-	K20TXR	5063	1.0	K20TT	IK20TT	IK20TT	4
1.5 dCi	42/45/50/62	K9K 704; K9K 714; K9K 716; K9K 718		07/03-	DG-005		11V				4
1.5 dCi (FC07, FC1R)	48	K9K 700; K9K 702; K9K 704		12/01-	DG-005		11V				4
1.5 dCi (FC08, FC09)	60	K9K 702; K9K 710		04/03-	DG-005		11V				4
1.5 dCi (FC1E)	50	K9K 714		06/05-	DG-005		11V				4
1.5 dCi (FC1G)	62	K9K 718		06/05-	DG-005		11V				4
1.5 dCi (FC1R)	42	K9K 704		12/02-	DG-005		11V				4
1.5 dCi (KC07)	48	K9K 700; K9K 704		03/03-12/05	DG-005		11V				4
1.5 dCi (KC08, KC09)	60	K9K 702; K9K 710		07/02-	DG-005		11V				4
1.6	66	K7M 746		09/99-06/01	K20TXR	5063	1.0	K20TT	IK20TT	IK20TT	4
1.6 16V	70	K4M 752		06/01-	K20PR-U	3145	0.8	K20TT	IK20TT	IK20TT	4
1.6 16V 4x4 (FC0L, FC0P, FC0S)	70	K4M 752		10/01-	K20PR-U	3145	0.8	K20TT	IK20TT	IK20TT	4
1.6 16V 4x4 (KC0P, KC0S, KC0L)	70	K4M 752		10/01-	K20PR-U	3145	0.8	K20TT	IK20TT	IK20TT	4
1.6 16V bivalent	60	K4M.7.54(GNV)	Flexible fuel	06/05-12/07	K20PR-U	3145	0.8	K20TT	IK20TT	IK20TT	4
1.9 D (FC0J)	48	F8Q 632		09/99-06/03	DG-112		11V				4
1.9 dCi (FC0V)	62	F9Q 782; F9Q 790		07/03-	DG-005		11V				4
1.9 dCi 4x4	62	F9Q 790		10/03-	DG-005		11V				4
1.9 dCi 4x4 (FC0V)	59/62	F9Q 782; F9Q 790		10/01-	DG-005		11V				4
1.9 dCi 4x4 (KC0V)	59	F9Q 782; F9Q 790		10/01-	DG-005		11V				4
1.9 dTi (FC0U)	59	F9Q 780		02/00-02/03	DG-005		11V				4
1.9 dTi (KC0U)	59	F9Q 780		02/00-02/03	DG-005		11V				4
D 55 1.9 (FC0D)	40	F8Q 662		08/97-	DG-008		11V				4
D 55 1.9 (KC0D)	40	F8Q 662		08/97-	DG-008		11V				4
D 65 1.9 (FC0E, FC02, FC0J, FC0N)	47	F8Q.630		08/97-	DG-008		11V				4
D 65 1.9 (FC0E, FC02, FC0J, FC0N)	47	F8Q.632		08/97-	DG-112		11V				4
D 65 1.9 (KC0E, KC02, KC0J, KC0N)	47	F8Q.630		08/97-02/03	DG-008		11V				4







Spark & Glow Plugs







Application Tables









	KW					Standard		Twin Tip		QTY	
RENAULT <i>continued</i>											
KANGOO (97-) <i>continued</i>											
D 65 1.9 (KC0E, KC0Z, KC0J, KC0N)	47	F8Q.632		03/03-12/06	DG-112		11V			4	
KANGOO (08-)											
1.5 dCi	50/ 55/ 78/ 80	K9K 608; K9K 800; K9K 802; K9K 804		02/08-	DG-005		11V			4	
1.5 dCi	55/ 66/ 78/ 80	K9K 608; K9K 802; K9K 804; K9K 808		03/11-	DG-609		4.4V			4	
1.5 dCi (FW0F)	76	K9K 806		02/08-	DG-005		11V			4	
1.5 dCi (KW0A)	50	K9K 800		02/08-	DG-005		11V			4	
1.5 dCi (KW0B)	63	K9K 802		02/08-	DG-005		11V			4	
1.5 dCi (KW0B)	63	K9K 802		02/08-	DG-609		4.4V			4	
1.5 dCi (KW0C, KW0F)	76	K9K 804; K9K 806		02/08-	DG-005		11V			4	
1.5 dCi (KW0F)	76	K9K 806		02/09-	DG-005		11V			4	
1.5 dCi (KW0G)	66	K9K 808		06/09-	DG-005		11V			4	
1.5 dCi (KW0G)	66	K9K 808		03/11-	DG-609		4.4V			4	
1.5 dCi 110	80	K9K 804		09/10-	DG-005		11V			4	
1.5 dCi 110	80	K9K 804		03/11-	DG-609		4.4V			4	
1.5 dCi 75	55	K9K 802		09/10-	DG-005		11V			4	
1.5 dCi 75	55	K9K 802; K9K 808		09/10-	DG-609		4.4V			4	
1.5 dCi 85 (FW0A, FW0B)	63	K9K 800; K9K 802		02/08-	DG-005		11V			4	
1.5 dCi 90 (FW0G)	66	K9K 808		06/09-	DG-609		4.4V			4	
1.6	64	K7M 750		02/08-	K20PR-U	3145	0.8	K20TT	IK20TT	IK20TT	4
1.6 (KW00, KW0Y)	64	K7M 750		02/08-	K20PR-U	3145	0.8	K20TT	IK20TT	IK20TT	4
1.6 (KW0D)	78	K4M 830		02/09-	K20PR-U	3145	0.8	K20TT	IK20TT	IK20TT	4
1.6 16V	78	K4M 830; K4M.7.08;K4M.8.30(105); K4M.8.31(105)		02/08-	K20PR-U	3145	0.8	K20TT	IK20TT	IK20TT	4
1.6 16V Hi-Flex	78	K4M 834	Flexible fuel	02/08-	K20PR-U	3145	0.8	K20TT	IK20TT	IK20TT	4
1.6 16V (KW0D)	78	K4M.7.08;K4M.8.30(105); K4M.8.31(105)		02/08-	K20PR-U	3145	0.8	K20TT	IK20TT	IK20TT	4
KOLEOS (08-)											
2.5 (HY0C, HY0N)	126	2TR 700; 2TR 702; 2TR 703		09/08-	FXE20HR11	3439	1.1	-	IXEH20TT	IXEH20TT	4
2.5 4x4 (HY0C, HY0N)	126	2TR 700; 2TR 702; 2TR 703		09/08-	FXE20HR11	3439	1.1	-	IXEH20TT	IXEH20TT	4
LAGUNA I (93-01)											
1.6 16V (B568, B561)	79	K4M 720; K4M 724		11/97-03/01	K20TXR	5063	1.0	K20TT	IK20TT	IK20TT	4
1.6 16V (K568)	79	K4M 720; K4M 724		11/97-03/01	K20TXR	5063	1.0	K20TT	IK20TT	IK20TT	4
1.8	69/70	F3P 674; F3P 676		06/95-02/01	W20EPR-U	3047	0.8	W20TT	IW20TT	IW20TT	4
1.8 (B56A/B)	66	F3P 724		11/93-03/01	W20EPR-U	3047	0.8	W20TT	IW20TT	IW20TT	4
1.8 (B56S/T/0)	66	F3P 678		08/95-03/01	W20EPR-U	3047	0.8	W20TT	IW20TT	IW20TT	4
1.8 (B56Z)	69	F3P 724		08/95-08/99	IW20	5306	1.1	-	IW20TT	IW20TT	4
1.8 (K56S/T/0)	66	F3P 678		09/95-03/01	W20EPR-U	3047	0.8	W20TT	IW20TT	IW20TT	4
1.8 (K56Z)	69	F3P 724		09/95-03/01	W20EPR-U	3043	0.8	W20TT	IW20TT	IW20TT	4
1.8 16V (B563, B564)	88	F4P 760		04/98-03/01	K20TXR	5063	1.0	K20TT	IK20TT	IK20TT	4
1.8 16V (K563, K564)	88	F4P 760		04/98-03/01	K20TXR	5063	1.0	K20TT	IK20TT	IK20TT	4
1.9 dCi (B56W)	79	F9Q 718		09/99-03/01	DG-005		11V			4	
1.9 dCi (K56W)	79	F9Q 718		09/99-03/01	DG-005		11V			4	
1.9 dTi (B56J)	72	F9Q 710; F9Q 716; F9Q 717		10/97-03/01	DG-005		11V			4	
1.9 dTi (B56J)	72	F9Q 716		10/97-03/01	DG-101		11V			4	
1.9 dTi (K56J)	72	F9Q 710		10/97-03/01	DG-005		11V			4	
1.9 dTi (K56J)	72	F9Q 716		10/97-03/01	DG-101		11V			4	
2.0	103	N7Q 700; N7Q 704		06/95-02/01	K20PBR-S10	5061	1.0	K20TT	IK20TT	IK20TT	4
2.0	80/84	F3R 611; F3R 768		10/98-03/01	W20EPR-U	3047	0.8	W20TT	IW20TT	IW20TT	4
2.0 (556A)	102	F4R 780		09/99-02/01	K20PR-U	3145	0.8	K20TT	IK20TT	IK20TT	4
2.0 (B56C/H/N)	83	F3R 723		11/93-03/01	W20EPR-U	3047	0.8	W20TT	IW20TT	IW20TT	4
2.0 (K56C/H)	83	F3R 723		09/95-03/01	W20EPR-U	3047	0.8	W20TT	IW20TT	IW20TT	4
2.0 16V (556A/B)	103	F4R 780		09/99-03/01	K20PR-U	3145	0.8	K20TT	IK20TT	IK20TT	4
2.0 16V (A56A/B)	103	F4R 780		09/99-03/01	K20PR-U	3145	0.8	K20TT	IK20TT	IK20TT	4
2.0 16V (B56D/M)	102	N7Q 700; N7Q 704		06/95-03/01	K20PBR-S10	5061	1.0	K20TT	IK20TT	IK20TT	4
2.0 16V (K56D/M)	102	N7Q 700; N7Q 704		09/95-03/01	K20PBR-S10	5061	1.0	K20TT	IK20TT	IK20TT	4
2.2 D (B56F/2)	61	G8T 706; G8T 752; G8T 790; G8T 794		11/93-03/01	DG-101		11V			4	
2.2 D (K56F/2, S56F)	61	G8T 706; G8T 752; G8T 790; G8T 794		09/95-03/01	DG-101		11V			4	
2.2 dT (B569)	83	G8T 760		03/96-03/01	DG-101		11V			4	







	KW								QTY		
RENAULT <i>continued</i>											
LAGUNA I (93-01) <i>continued</i>											
2.2 dT (K569)	83	G8T 760		03/96-03/01	DG-101		11V		4		
3.0 (B56E/R, B565)	123	Z7X 765		11/93-06/98	K20PBR	5060	0.85	K20TT	IK20TT	IK20TT	6
3.0 (K56R, K565)	123	Z7X 765		02/96-03/01	K20TXR	5063	1.0	K20TT	IK20TT	IK20TT	6
3.0 24V (B56V)	140	L7X 701		03/97-03/01	K20TXR	5063	1.0	K20TT	IK20TT	IK20TT	6
3.0 24V (K56V)	140	L7X.7.00;L7X.7.01		03/97-03/01	PK20PR-P8	3245	0.8	-	IK20TT	IK20TT	6
LAGUNA II (01-)											
1.6 16V	82	K4M 716		02/05-09/07	K20PR-U	3145	0.8	K20TT	IK20TT	IK20TT	4
1.6 16V	82	K4M.7.14	Flexible fuel	02/05-09/07	K20PR-U	3145	0.8	K20TT	IK20TT	IK20TT	4
1.6 16V (BG0A, BG0L)	79	K4M.7.10;K4M.7.11; K4M.7.18		03/01-09/07	K20PR-U	3145	0.8	K20TT	IK20TT	IK20TT	4
1.6 16V (BG0A, BG0L)	79	K4M.7.14	Flexible fuel	03/05-09/07	K20PR-U	3145	0.8	K20TT	IK20TT	IK20TT	4
1.6 16V (BG1G, BG1H)	82	K4M 716		02/05-09/07	K20PR-U	3145	0.8	K20TT	IK20TT	IK20TT	4
1.6 16V (KG0A, KG0L)	79	K4M.7.10;K4M.7.11		03/01-09/07	K20PR-U	3145	0.8	K20TT	IK20TT	IK20TT	4
1.6 FlexFuel	76	K4M.7.14	Flexible fuel	06/01-10/03	K20PR-U	3145	0.8	K20TT	IK20TT	IK20TT	4
1.8 16V	86/89	F4P.7.71;F4P.7.72; F4P.7.74, F4P.7.75; F4P.7.74		03/01-09/07	K20PR-U	3145	0.8	K20TT	IK20TT	IK20TT	4
1.8 16V (BG04, BG0B, BG0C, BG0V)	86	F4P.7.74		03/01-02/05	K20PR-U	3145	0.8	K20TT	IK20TT	IK20TT	4
1.8 16V (BG06, BG0J, BG0M)	85	F4P.7.70; F4P.7.71; F4P.7.74; F4P.7.75		03/01-09/07	K20PR-U	3145	0.8	K20TT	IK20TT	IK20TT	4
1.8 16V (BG0B, BG0C, BG0J, BG0M, BG0V)	89	F4P.7.70;F4P.7.74		03/01-09/07	K20PR-U	3145	0.8	K20TT	IK20TT	IK20TT	4
1.8 16V (BG0B, BG0M)	88	F4P.7.70;F4P.7.72; F4P.7.73		03/01-09/07	K20PR-U	3145	0.8	K20TT	IK20TT	IK20TT	4
1.8 16V (KG0B, KG0M)	88	F4P.7.70;F4P.7.72; F4P.7.73		03/01-09/07	K20PR-U	3145	0.8	K20TT	IK20TT	IK20TT	4
1.8 16V (KG0J)	85	F4P.7.70;F4P.7.71; F4P.7.74, F4P.7.75		03/01-09/07	K20PR-U	3145	0.8	K20TT	IK20TT	IK20TT	4
1.9 dCi	66/ 79/ 85/ 92	F9Q 718; F9Q 754		08/03-	DG-005		11V				4
1.9 dCi (BG05)	68	F9Q 664		03/04-	DG-005		11V				4
1.9 dCi (BG08, BG0G)	88	F9Q 650; F9Q 670; F9Q 674; F9Q 750		03/01-	DG-005		11V				4
1.9 dCi (BG0E)	77	F9Q 752		06/01-	DG-005		11V				4
1.9 dCi (BG0R)	74	F9Q 754		10/01-	DG-005		11V				4
1.9 dCi (BG1A, BG1V)	96	F9Q 758; F9Q 759		05/05-	DG-005		11V				4
1.9 dCi (BG1A, BG1W)	81	F9Q 674; F9Q 758		01/05-	DG-005		11V				4
1.9 dCi (KG05)	68	F9Q 664		03/04-	DG-005		11V				4
1.9 dCi (KG0E)	77	F9Q 752		06/01-	DG-005		11V				4
1.9 dCi (KG0E, KG0R)	74	F9Q 752		10/01-	DG-005		11V				4
1.9 dCi (KG0G)	88	F9Q 670; F9Q 674; F9Q 750		03/01-	DG-005		11V				4
1.9 dCi (KG12)	85	F9Q 758; F9Q 759		08/05-09/07	DG-005		11V				4
1.9 dCi (KG1A, KG1W)	81	F9Q 674; F9Q 758		01/05-	DG-005		11V				4
1.9 dCi (KG1V)	96	F9Q 758; F9Q 759		05/05-	DG-005		11V				4
2.0 16V	98/ 125	F4R 714; F4R.7.87		08/02-09/07	K20PR-U	3145	0.8	K20TT	IK20TT	IK20TT	4
2.0 16V	150	F4R.7.86(205)		01/05-09/07	PK20PR-P8	3245	0.8	-	IK20TT	IK20TT	4
2.0 16V	150	F4R.7.84		01/05-09/07	VK22	5610	0.8	-	-	VK22	4
2.0 16V	125/ 150	F4R.7.86 ;F4R.7.87; F4R.7.86(205)	OEM Optional	01/05-09/07	PK20PR-P8	3245	0.8	-	IK20TT	IK20TT	4
2.0 16V (BG00, BG0K, BG0P, BG0W)	99	F4R 715		08/02-	K20PR-U	3145	0.8	K20TT	IK20TT	IK20TT	4
2.0 16V (KG00, KG0K, KG0W)	99	F4R.7.12;F4R.7.13; F4R.7.14, F4R.7.15		08/02-09/07	K20PR-U	3145	0.8	K20TT	IK20TT	IK20TT	4
2.0 16V IDE (BG0N)	103	F5R 700; F5R 701		04/01-09/07	K16HPR-U11	6076	1.1	KH16TT	IKH16TT	IKH16TT	4
2.0 16V IDE (KG0N)	103	F5R 700; F5R 701		04/01-09/07	K16HPR-U11	6076	1.1	KH16TT	IKH16TT	IKH16TT	4
2.0 16V Turbo (BG0S, BG0Z, BG1L, BG1M)	120	F4R.7.64;F4R.7.65		01/03-09/07	PK20PR-P8	3245	0.8	-	IK20TT	IK20TT	4
2.0 16V Turbo (KG0S, KG0Z, KG1L, KG1M)	120	F4R.7.64;F4R.7.65		01/03-09/07	PK20PR-P8	3245	0.8	-	IK20TT	IK20TT	4
2.2 dCi	102	G9T 600; G9T 605; G9T 706; G9T 707		05/05-	DG-005		11V				4
2.2 dCi (BG0F)	110	G9T 700; G9T 702		10/01-	DG-126		11V				4
2.2 dCi (KG0F)	110	G9T 702		10/01-	DG-126		11V				4
3.0 V6 24V (BG01, BG02, BG0D, BG0Y)	152	L7X 731		03/05-09/07	IKH20	5344	1.1	-	IKH20TT	IKH20TT	6
3.0 V6 24V (KG0D)	152	L7X 731		03/05-09/07	IKH20	5344	1.1	-	IKH20TT	IKH20TT	6
LAGUNA III (07-)											
1.5 dCi	81	K9K 846		03/12-	DG-609		4.4V				4





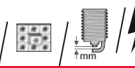

	KW					Standard		Twin Tip		QTY
RENAULT <i>continued</i>										
LAGUNA III (07-) continued										
1.5 dCi (BT00, BT0A, BT0T, BT1J)	81	K9K 780		10/07-	DG-005		11V			4
1.5 dCi (BT00, BT0A, BT0T, BT1J)	81	K9K 780		11/10-	DG-609		4.4V			4
1.5 dCi (KT0A)	81	K9K 780		10/07-	DG-005		11V			4
1.5 dCi (KT0A)	81	K9K 780		11/10-	DG-609		4.4V			4
1.6 16V (BT04, BT0D, BT0U)	81	K4M 824		10/07-	K20PR-U	3145	0.8	K20TT	IK20TT	IK20TT
1.6 16V (KT0D)	81	K4M 824		10/07-	K20PR-U	3145	0.8	K20TT	IK20TT	IK20TT
2.0 16V (BT05, BT0F, BT0W)	103	M4R 704		10/07-	FXE20HR11	3439	1.1	-	IXEH20TT	IXEH20TT
2.0 16V (KT0F, KT0W)	103	M4R 704		10/07-	FXE20HR11	3439	1.1	-	IXEH20TT	IXEH20TT
2.0 16V Hi-Flex (BT1H)	103	M4R 726		10/07-	FXE20HR11	3439	1.1	-	IXEH20TT	IXEH20TT
2.0 16V Hi-Flex (KT1H)	103	M4R 704; M4R 726		10/07-	FXE20HR11	3439	1.1	-	IXEH20TT	IXEH20TT
2.0 16V Turbo	125	F4R 811; F4Rt 811		10/07-	PK20PR-P8	3245	0.8	-	IK20TT	IK20TT
2.0 16V Turbo	125	F4R 811	OEM Optional	10/07-	VK22	5610	0.8	-	-	VK22
2.0 GT	150	F4R 800		03/08-	VK22	5610	0.8	-	-	VK22
3.5 V6 (DT0P)	175	V4Y 713		09/08-	FXE20HR11	3439	1.1	-	IXEH20TT	IXEH20TT
LATITUDE (10-)										
1.5 dCi (L70R)	81	K9K 782		07/10-	DG-609		4.4V			4
2.0 16V (L70B)	103	M4R 746		02/11-	FXE20HR11	3439	1.1	-	IXEH20TT	IXEH20TT
2.0 16V eco2 (L70B)	103	M4R 746		02/11-	FXE20HR11	3439	1.1	-	IXEH20TT	IXEH20TT
LOGAN I (04-)										
1.4	55	K7J 710		09/04-	K20PR-U	3145	0.8	K20TT	IK20TT	IK20TT
1.5 dCi	48/ 50/ 63/ 66	K9K 790; K9K 792; K9K 794; K9K 796		06/11-	DG-005		11V			4
1.5 dCi	63	K9K 796		11/12-	DG-609		4.4V			4
1.6	64/77	K4M 690; K4M 697; K7M 710		04/07-	K20PR-U	3145	0.8	K20TT	IK20TT	IK20TT
LOGAN II (13-)										
1.2	55	D4F 732		11/13-	XE20HR-U9	3427	0.9	-	IXEH20TT	IXEH20TT
MASTER I (80-98)										
2.2	71	J7T 788		08/93-02/98	T20EPR-U	5032	0.8	T20TT	IT20TT	IT20TT
2.4 D	53	S8U 731		09/86-10/89	DG-001		11V			4
2.5 DT	69	S9U 702		11/89-10/93	DG-001		11V			4
2.5 DT	70	S9U 740		08/93-02/98	DG-004		11.5V			4
28-35 2,5 D	55	S8U 742		08/89-07/98	DG-001		11V			4
28-35 2,5 TD	72	Sofim-8140.27.2580		08/89-07/98	DG-001		11V			4
28-35 2.0	58/59	829 730; 829 731; J5R 718; J5R.7.18		08/80-07/98	W20EPR-U	3047	0.8	W20TT	IW20TT	IW20TT
28-35 2.1 D	44	J8S 330		08/80-07/98	DG-001		11V			4
28-35 2.4 D	52	8140.61.2300; S8U 731		08/80-08/89	DG-001		11V			4
28-35 2.5 D	52/55	8140.61.2300; S8U 731; S8U 742		09/80-07/98	DG-001		11V			4
30 2,2	67	J7T 782		08/80-07/98	T20EPR-U	5032	0.8	T20TT	IT20TT	IT20TT
35 2,5 TD	69	8140.27.2500; 8140.27.2510; S9U 714; S9U 740		08/89-07/98	DG-004		11.5V			4
MASTER II (98-)										
1.9 dCi 80	60	F9Q 772; F9Q 774		11/01-	DG-005		11V			4
1.9 dTi	59	F9Q 770		09/00-	DG-005		11V			4
2.2 dCi 90	66	G9T 720; G9T 722; G9T 750		09/00-	DG-126		11V			4
2.5 D	59	S8U 770		07/98-01/01	DG-111		11V			4
2.5 dCi	74/ 84/ 88/ 107	G9U 632; G9U 650; G9U 750; G9U 754		08/06-	DG-126		11V			4
2.5 dCi 100 (ED4V, ED8V)	73	G9U 754		10/03-10/06	DG-126		11V			4
2.5 dCi 100 (FD0U, FD0V)	73	G9U 754		10/03-	DG-126		11V			4
2.5 dCi 100 (JDCV)	73	G9U 754		10/03-	DG-126		11V			4
2.5 dCi 120	84	G9U 720; G9U 724; G9U 754		10/01-09/03	DG-126		11V			4
2.8 dTi	84	S9W 702		07/98-10/01	DG-111		11V			4
3.0 dCi 120	85	ZD3 600		06/05-	DG-605		11V			4
3.0 dCi 140 (ED0S, UD0S)	100	ZD3 202		10/03-05/06	DG-605		11V			4
3.0 dCi 140 (HD0S, FD0S, HD1S)	100	ZD3 202		10/03-05/06	DG-605		11V			4
3.0 dCi 140 (JD0T)	100	ZD3 200; ZD3 202		10/03-	DG-605		11V			4
3.0 dCi 160	115	ZD3 A 604		06/05-	DG-605		11V			4







	KW					Standard			Twin Tip			QTY	
RENAULT <i>continued</i>													
MEGANE I (96-03)													
1.4 (LA0E, LA0V)	55	E7J 764		09/96-08/03	Q16PR-U	3137	0.8	Q16TT	IQ16TT	IQ16TT		4	
1.4 16V (BA0D, BA1H, BA0W, BA10)	70	K4J 714		03/99-08/03	Q16PR-U	3137	0.8	Q16TT	IQ16TT	IQ16TT		4	
1.4 16V (DA0D, DA1H, DA0W, DA10)	70	K4J 714		03/99-08/03	K20PR-U	3145	0.8	K20TT	IK20TT	IK20TT		4	
1.4 16V (EA0D, EA1H, EA0W, EA10)	70	K4J 714		03/99-08/03	K20PR-U	3145	0.8	K20TT	IK20TT	IK20TT		4	
1.4 16V (KA0D, KA1H, KA0W, KA10)	70	K4J 714		03/99-08/03	K20PR-U	3145	0.8	K20TT	IK20TT	IK20TT		4	
1.4 16V (LA0D, LA1H, LA0W, LA10)	70	K4J 714		03/99-08/03	K20PR-U	3145	0.8	K20TT	IK20TT	IK20TT		4	
1.4 e (BA0E, BA0V)	55	E7J 764		01/96-08/03	Q16PR-U	3137	0.8	Q16TT	IQ16TT	IQ16TT		4	
1.4 e (KA0V)	55	E7J.6.26		03/99-10/00	K20PR-U	3145	0.8	K20TT	IK20TT	IK20TT		4	
1.4 Eco (BA0T)	52	E7J 624		01/96-03/99	Q16PR-U	3137	0.8	Q16TT	IQ16TT	IQ16TT		4	
1.6 16V (BA11, BA04, BA0B, BA1J)	79	K4M 704		03/99-08/03	Q16PR-U	3137	0.8	Q16TT	IQ16TT	IQ16TT		4	
1.6 16V (DA0B, DA04, DA11)	79	K4M 708		03/99-08/03	K20PR-U	3145	0.8	K20TT	IK20TT	IK20TT		4	
1.6 16V (EA0B, EA04, EA11)	79	K4M 708		03/99-08/03	K20PR-U	3145	0.8	K20TT	IK20TT	IK20TT		4	
1.6 16V (KA0B, KA04, KA11)	79	K4M 704		03/99-08/03	K20PR-U	3145	0.8	K20TT	IK20TT	IK20TT		4	
1.6 16V (La04, LA11, LA0B, LA1C, LA1J)	79	K4M 708		03/99-08/03	K20PR-U	3145	0.8	K20TT	IK20TT	IK20TT		4	
1.6 e (BA0F, BA0S)	66	K7M 790		01/96-03/99	Q16PR-U	3137	0.8	Q16TT	IQ16TT	IQ16TT		4	
1.6 e (DA0F)	66	K7M 702		03/96-03/99	Q16PR-U	3137	0.8	Q16TT	IQ16TT	IQ16TT		4	
1.6 e (EA0F)	66	K7M 702		10/96-03/99	K20TXR	5063	1.0	K20TT	IK20TT	IK20TT		4	
1.6 e (KA0F)	66	K7M 702		03/99-08/03	K20PR-U	3145	0.8	K20TT	IK20TT	IK20TT		4	
1.6 e (LA0F, LA0S)	66	K7M 702; K7M 703; K7M 790		09/96-03/99	K20TXR	5063	1.0	K20TT	IK20TT	IK20TT		4	
1.6 i (BA0L)	55	K7M 720		01/96-03/99	Q16PR-U	3137	0.8	Q16TT	IQ16TT	IQ16TT		4	
1.6 i (LA0L)	55	K7M 720		09/96-03/99	Q16PR-U	3137	0.8	Q16TT	IQ16TT	IQ16TT		4	
1.8 16V (BA06, BA12, BA1A, BA1M, BA1R)	85	F4P 720; F4P 722		01/01-08/03	K20PR-U	3145	0.8	K20TT	IK20TT	IK20TT		4	
1.8 16V (KA0S, KA12, KA1A, KA1M, KA1R)	85	F4P 720; F4P 722		01/01-08/03	K20PR-U	3145	0.8	K20TT	IK20TT	IK20TT		4	
1.8 16V (LA06, LA12, LA1A, LA1M, LA1R)	85	F4P 720; F4P 722		01/01-08/03	K20PR-U	3145	0.8	K20TT	IK20TT	IK20TT		4	
1.9 D (KA0J, KA0R)	47	F8Q 622; F8Q 790		04/99-08/03	DG-112		11V					4	
1.9 D (LA0A, LA0U)	47	F8Q 620; F8Q 624		09/96-08/03	DG-009		11V					4	
1.9 D Eco (B/SA0U, BA0A)	47	F8Q 620; F8Q 624		01/96-08/03	DG-009		11V					4	
1.9 DCi	77	F9Q 732; F9Q 733		03/99-08/03	DG-005		11V					4	
1.9 dCi (BA05, BA1F)	75	F9Q 732; F9Q 733		02/01-08/03	DG-005		11V					4	
1.9 dCi (DA05, DA1F)	75	F9Q 732; F9Q 733		02/01-08/03	DG-005		11V					4	
1.9 dCi (KA05, KA1F)	75	F9Q 732; F9Q 733; F9Q 738		02/01-08/02	DG-005		11V					4	
1.9 dCi (LA05, LA1F)	75	F9Q 732; F9Q 733; F9Q 738		02/01-08/03	DG-005		11V					4	
1.9 dT (B/SA0K, B/SA0Y)	66	F8Q 784; F8Q 786		01/96-08/03	DG-012		11V					4	
1.9 dT (LA0K, LA0Y)	66	F8Q 784; F8Q 786		09/96-08/03	DG-012		11V					4	
1.9 dTi (BA08, BA0N)	72	F9Q 730; F9Q 731; F9Q 734; F9Q 736		03/97-02/01	DG-005		11V					4	
1.9 dTi (BA08, BA0N)	72	F9Q 730, F9Q 734		03/97-02/01	DG-101		11V					4	
1.9 dTi (BA1U)	59	F9Q 744		02/01-08/03	DG-005		11V					4	
1.9 dTi (DA0N)	72	F9Q 731, F9Q 736		03/97-02/01	DG-005		11V					4	
1.9 dTi (DA0N)	72	F9Q 734		03/97-02/01	DG-010		11.5V					4	
1.9 dTi (KA0N)	72	F9Q 731; F9Q 736		03/99-02/01	DG-005		11V					4	
1.9 dTi (KA1U)	59	F9Q 744		02/01-08/02	DG-005		11V					4	
1.9 dTi (LA08, LA0N)	72	F9Q 731, F9Q 736		03/97-02/01	DG-005		11V					4	
1.9 dTi (LA08, LA0N)	72	F9Q 730, F9Q 734		03/97-02/01	DG-101		11V					4	
1.9 dTi (LA1U)	59	F9Q 744		02/01-08/03	DG-005		11V					4	
1.9 TDI	69	F8Q 784		09/96-08/03	DG-012		11V					4	
2.0	85			05/98-05/01	W16EPR-U	3021	0.8	W16TT	IW16TT	IW16TT		4	
2.0 (EA0G)	84	F3R 750		04/97-08/03	W20EPR-U	3047	0.8	W20TT	IW20TT	IW20TT		4	
2.0 16V	102	F4R 770; F4R.7.46		01/02-08/03	K20PR-U	3145	0.8	K20TT	IK20TT	IK20TT		4	
2.0 16V (BA0H)	108	F7R 710		07/96-08/03	K20PBR	5060	0.85	K20TT	IK20TT	IK20TT		4	
2.0 16V (DA0H)	108	F7R 710		03/96-11/99	K20PBR	5060	0.85	K20TT	IK20TT	IK20TT		4	
2.0 16V (EA0H)	108	F7R 710		10/96-11/99	K20PBR	5060	0.85	K20TT	IK20TT	IK20TT		4	
2.0 16V IDE (DA03, DA0P, DA14)	103	F5R 740		11/99-08/03	K16HPR-U11	6076	1.1	KH16TT	IKH16TT	IKH16TT		4	
2.0 16V IDE (EA03, EA0P, EA14)	103	F5R 740		11/99-08/03	K16HPR-U11	6076	1.1	KH16TT	IKH16TT	IKH16TT		4	
2.0 i	80	F5R.7.40		03/99-10/00	K16HPR-U11	6076	1.1	KH16TT	IKH16TT	IKH16TT		4	
2.0 i	80	F3R 791; F3R 796		03/99-08/03	W20EPR-U	3047	0.8	W20TT	IW20TT	IW20TT		4	











	KW					Standard			Twin Tip			QTY	
RENAULT <i>continued</i>													
MEGANE I (96-03) <i>continued</i>													
2.0 i	80	F3R 750		03/99-08/03	W20EP-U	3043	0.8	W20TT	IW20TT	IW20TT		4	
2.0 i (BA0G)	84	F3R 750		01/96-08/03	W20EP-U	3043	0.8	W20TT	IW20TT	IW20TT		4	
2.0 i (DA0G)	84	F3R 750		03/96-08/03	W20EP-U	3043	0.8	W20TT	IW20TT	IW20TT		4	
2.0 i (EA0G)	80	F3R 791; F3R 796		03/99-02/03	W20EPR-U	3047	0.8	W20TT	IW20TT	IW20TT		4	
2.0 i (LA07, LA0G)	84	F3R 750		09/96-08/03	W20EP-U	3043	0.8	W20TT	IW20TT	IW20TT		4	
2.0 i (LA0G)	80	F3R 752		03/99-08/03	K20PR-U	3145	0.8	K20TT	IK20TT	IK20TT		4	
MEGANE II (02-)													
1.4	60/72	K4J 732; K4J.7.30(98);K4J.7.40(98)		09/03-10/08	K20PR-U	3145	0.8	K20TT	IK20TT	IK20TT		4	
1.4 16V	60	K4J 732		10/03-12/05	K20PR-U	3145	0.8	K20TT	IK20TT	IK20TT		4	
1.4 16V (BM0B, CM0B)	72	K4J.7.30(98);K4J.7.40(98)		11/02-10/08	K20PR-U	3145	0.8	K20TT	IK20TT	IK20TT		4	
1.5 dCi	60/63/74/76/78	K9K 722; K9K 724; K9K 728; K9K 729; K9K 732; K9K 734		08/03-	DG-005		11V					4	
1.5 dCi (BM0F, CM0F)	60	K9K 722		11/02-	DG-005		11V					4	
1.5 dCi (EM16)	76	K9K 734		01/07-	DG-005		11V					4	
1.5 dCi (EM1E)	78	K9K 732		03/06-	DG-005		11V					4	
1.5 dCi (KM13)	76	K9K 728		01/07-	DG-005		11V					4	
1.5 dCi (KM16, KM1E)	78	K9K 732; K9K 734		05/05-	DG-005		11V					4	
1.6	77/83	K4M 760; K4M 761; K4M 762; K4M 788		09/03-	K20PR-U	3145	0.8	K20TT	IK20TT	IK20TT		4	
1.6 16V	82	K4M.7.61;K4M.8.12; K4M.8.12; K4M.8.13; K4M.8.13		01/06-10/08	K20PR-U	3145	0.8	K20TT	IK20TT	IK20TT		4	
1.6 16V Hi-Flex	77	K4M 856		02/08-	K20PR-U	3145	0.8	K20TT	IK20TT	IK20TT		4	
1.6 16V (BM0C, CM0C)	83	K4M 760		11/02-10/08	K20PR-U	3145	0.8	K20TT	IK20TT	IK20TT		4	
1.6 Flex-Fuel	77	K4M 788		01/07-	PK20PR-P8	3245	0.8	-	IK20TT	IK20TT		4	
1.6 Hi-Flex	85			03/06-	PK20PR-P8	3245	0.8	-	IK20TT	IK20TT		4	
1.9 dCi	66/68/81/85/88/96	F9Q 800; F9Q 803; F9Q 804; F9Q 808; F9Q 816; F9Q 818		04/04-	DG-005		11V					4	
1.9 dCi (BM0G, CM0G)	88	F9Q 800		11/02-	DG-005		11V					4	
1.9 dCi (LM0G, LM1G, LM2C)	88	F9Q 800		09/03-	DG-005		11V					4	
1.9 dCi (LM14, LM1D)	81	F9Q 803; F9Q 804; F9Q 816; F9Q 818		05/05-	DG-005		11V					4	
2.0	99	F4R 770; F4R 771		08/03-10/08	K20PR-U	3145	0.8	K20TT	IK20TT	IK20TT		4	
2.0	169	F4R 774		08/06-	VK22	5610	0.8	-	-	VK22		4	
2.0 16V (BM0U, CM0U)	99	F4R 770		11/02-10/08	K20PR-U	3145	0.8	K20TT	IK20TT	IK20TT		4	
2.0 16V Turbo	120	F4R 776		05/04-01/09	VK22	5610	0.8	-	-	VK22		4	
2.0 Renault Sport	165	F4Rt 774		05/04-12/06	PK22PR8	3273	0.8	-	-	VK22		4	
2.0 Renault Sport	165	F4R 774		05/04-12/05	VK22	5610	0.8	-	-	VK22		4	
MEGANE III (08-)													
1.5 dCi	63/70/78/96	K9K 830; K9K G 832		11/08-	DG-609		4.4V					4	
1.5 dCi (BZ09, BZ0D)	81	K9K 836; K9K 836; K9K 837; K9K 846		02/09-	DG-609		4.4V					4	
1.5 dCi (BZ0C)	66	K9K H 834		11/08-	DG-609		4.4V					4	
1.5 dCi (DZ09, DZ0D, DZ1F, DZ1G)	81	K9K 837; K9K J 836		02/09-	DG-609		4.4V					4	
1.5 dCi (DZ0A)	63	K9K 830		11/08-	DG-609		4.4V					4	
1.5 dCi (DZ0B)	78	K9K G 832		02/09-	DG-609		4.4V					4	
1.5 dCi (DZ0C, DZ1A)	66	K9K H 834		11/08-	DG-609		4.4V					4	
1.5 dCi (EZ09, EZ1G, EZ0D)	81	K9K 837		06/10-	DG-609		4.4V					4	
1.5 dCi (KZ09, KZ0D, KZ1G, KZ1M, KZ1W)	81	K9K 836; K9K 836; K9K 837; K9K 846		02/09-	DG-609		4.4V					4	
1.5 dCi (KZ0C, KZ1A)	66	K9K 834		05/09-	DG-609		4.4V					4	
1.5 dCi (KZ1M, KZ1W)	78	K9K 836; K9K 846		02/09-	DG-609		4.4V					4	
1.6 16V (BZ0H)	74	K4M 848		11/08-	K20PR-U	3145	0.8	K20TT	IK20TT	IK20TT		4	
1.6 16V (BZ1B, BZ1H)	81	K4M 858		11/08-	K20PR-U	3145	0.8	K20TT	IK20TT	IK20TT		4	
1.6 16V (DZ0H)	74	K4M 848		11/08-	K20PR-U	3145	0.8	K20TT	IK20TT	IK20TT		4	
1.6 16V (DZ0U, DZ1B, DZ1H)	81	K4M 858		11/08-	K20PR-U	3145	0.8	K20TT	IK20TT	IK20TT		4	
1.6 16V (EZ0U, EZ1U)	81	K4M 858		06/10-	K20PR-U	3145	0.8	K20TT	IK20TT	IK20TT		4	

RENAULT <i>continued</i>	KW				Standard			Twin Tip			QTY
											
MEGANE III (08-) <i>continued</i>											
1.6 16V (KZ0H)	74	K4M 848		05/09-	K20PR-U	3145	0.8	K20TT	IK20TT	IK20TT	4
1.6 16V (KZ0U, KZ1B, KZ1U)	81	K4M 858		05/09-	K20PR-U	3145	0.8	K20TT	IK20TT	IK20TT	4
1.6 16V Bifuel (BZ03)	81	K4M 866		11/08-	PK20PR-P8	3245	0.8	-	IK20TT	IK20TT	4
1.6 16V Bifuel (DZ03, DZ1Y)	81	K4M 866		11/08-	PK20PR-P8	3245	0.8	-	IK20TT	IK20TT	4
1.6 16V Bifuel (KZ03)	81	K4M 866		11/08-	PK20PR-P8	3245	0.8	-	IK20TT	IK20TT	4
1.9 dCi	96	F9Q 870; F9Q 872		06/09-	DG-619		4.4V				4
1.9 dCi (BZ0N, BZ0J)	96	F9Q 870; F9Q 872		11/08-	DG-619		4.4V				4
1.9 dCi (DZ0N, DZ0J, DZ1J, DZ1K)	96	F9Q 870; F9Q 872		11/08-	DG-619		4.4V				4
1.9 dCi (EZ0J, EZ1S)	96	F9Q 870		06/10-	DG-619		4.4V				4
1.9 dCi (KZ0J, KZ0N, KZ1S)	96	F9Q 870; F9Q 872		05/09-	DG-619		4.4V				4
2.0 CVT (BZ0G, BZ1P)	103	M4R 711; M4R 713		02/09-	FXE20HR11	3439	1.1	-	IXEH20TT	IXEH20TT	4
2.0 CVT (DZ0G, DZ1E)	103	M4R 711		05/09-	FXE20HR11	3439	1.1	-	IXEH20TT	IXEH20TT	4
2.0 CVT (EZ0G, EZ1E, EZ1P)	103	M4R 711; M4R 713		06/10-	FXE20HR11	3439	1.1	-	IXEH20TT	IXEH20TT	4
2.0 CVT (KZ0G, KZ1P)	103	M4R 711; M4R F 713		05/09-	FXE20HR11	3439	1.1	-	IXEH20TT	IXEH20TT	4
2.0 TCe	162			09/12-	VK22	5610	0.8	-	-	VK22	4
2.0 TCe (BZ0K)	132	F4R 870		11/08-	PK20PR-P8	3245	0.8	-	IK20TT	IK20TT	4
2.0 TCe (DZ0K)	132	F4R 870		11/08-	PK20PR-P8	3245	0.8	-	IK20TT	IK20TT	4
2.0 TCe (EZ1T)	132	F4R 870; F4R 872		06/10-	PK20PR-P8	3245	0.8	-	IK20TT	IK20TT	4
2.0 TCe (KZ0K, KZ1T)	132	F4R 870; F4R 872		11/08-	PK20PR-P8	3245	0.8	-	IK20TT	IK20TT	4
MEGANE Scénic (96-99)											
1.4 i (JA0E)	55	E7J 764		01/97-09/99	Q16PR-U	3137	0.8	Q16TT	IQ16TT	IQ16TT	4
1.6 16V (JA0B, JA04, JA11)	79	K4M 700; K4M 701; K4M 704; K4M 708		04/98-10/99	K20TXR	5063	1.0	K20TT	IK20TT	IK20TT	4
1.6 e (JA0F)	66	K7M 703		10/96-10/99	Q16PR-U	3137	0.8	Q16TT	IQ16TT	IQ16TT	4
1.6 i (JA0L)	55	K7M 720		01/97-09/99	Q16PR-U	3137	0.8	Q16TT	IQ16TT	IQ16TT	4
1.9 D (JA0J)	47	F8Q 788		03/97-09/99	DG-008		11V				4
1.9 D (JA0J)	47	F8Q 620, 624		03/97-09/99	DG-009		11V				4
1.9 D (JA0J)	47	F8Q 622, 790		03/97-09/99	DG-112		11V				4
1.9 dT (JA0K, JA0Y)	66	F8Q 784; F8Q 786		01/97-09/99	DG-012		11V				4
1.9 dTi (JA0N)	72	F9Q 730; F9Q 734		04/97-09/99	DG-101		11V				4
2.0 i (JA0G)	80/84	F3R 750; F3R 796		01/97-09/99	W20EP-U	3043	0.8	W20TT	IW20TT	IW20TT	4
MODUS (04-)											
1.2 (FP0C, FP0K, FP0P)	48	D4F 740		05/05-12/07	XE20HR-U9	3427	0.9	-	IXEH20TT	IXEH20TT	4
1.2 (JP0C, JP0K, FP0C, FP0K, FP0P, JP0P, JP0T)	55	D4F 740		12/04-	XE20HR-U9	3427	0.9	-	IXEH20TT	IXEH20TT	4
1.2 (JP0S)	58	D4F 764		12/04-	XE20HR-U9	3427	0.9	-	IXEH20TT	IXEH20TT	4
1.2 16V Hi-Flex	55	D4F 740		10/08-	XE20HR-U9	3427	0.9	-	IXEH20TT	IXEH20TT	4
1.4 (JP01, JP0J)	72	K4J 770; K4J 780		12/04-	K20PR-U	3145	0.8	K20TT	IK20TT	IK20TT	4
1.5 dCi (FP0D, JP0D)	60	K9K 750		09/04-	DG-005		11V				4
1.5 dCi (FP0E, JP0E)	48	K9K 752		12/04-	DG-005		11V				4
1.5 dCi (FP0F, JP0F)	63	K9K 760; K9K 766		12/04-	DG-005		11V				4
1.5 dCi (FP0G, JP0G)	50	K9K 762; K9K 768		12/04-	DG-005		11V				4
1.5 dCi (JP02)	76	K9K 772		10/10-	DG-005		11V				4
1.5 dCi (JP02)	76	K9K 772		11/10-	DG-609		4.4V				4
1.5 dCi (JP0G, JP0H)	78	K9K 764		05/05-	DG-005		11V				4
1.5 dCi 75	55	K9K 770		10/10-	DG-609		4.4V				4
1.5 dCi 90	65	K9K 750		10/10-	DG-609		4.4V				4
1.6 (JP03, JP0B, JP0U, JP0Y, JP1G)	82	K4M.7.90; K4M.7.91; K4M.8.00, K4M.8.01		12/04-	K20PR-U	3145	0.8	K20TT	IK20TT	IK20TT	4
1.6 (JP0L, JP0V)	65	K4M 794		12/04-12/07	K20PR-U	3145	0.8	K20TT	IK20TT	IK20TT	4
RAPID (85-98)											
1.0	27	C1C 706		02/86-05/92	W20EPR-U	3047	0.8	W20TT	IW20TT	IW20TT	4
1.1	34	C1E 750		09/85-08/91	W16EPR-U	3021	0.8	W16TT	IW16TT	IW16TT	4
1.1 (F401)	33	C1E.7.62; C1E.7.64		09/91-04/95	W14EPR-U	6011	0.8	-	IW16TT	IW16TT	4
1.1 (F401)	33	C1E 762		07/85-04/95	W16EPR-U	3021	0.8	W16TT	IW16TT	IW16TT	4
1.1 (F40H)	33	C1E.7.56		06/87-09/91	W14EPR-U	6011	0.8	-	IW16TT	IW16TT	4
1.1 (F40H)	33	C1E 756		06/87-09/91	W16EPR-U	3021	0.8	W16TT	IW16TT	IW16TT	4
1.2	40	C1G.7.26		09/91-08/93	W14EPR-U	6011	0.8	-	IW16TT	IW16TT	4
1.2 (F406, G40A)	40	C3G.7.10; C3G.7.12		07/93-03/98	W16EXR-U	3031	0.8	W16TT	IW16TT	IW16TT	4
1.4	59	E6J.7.34; E6J.7.38; E7J.7.20, E7J.7.24, E7J.7.26, E7J.7.28		05/95-08/97	K20PR-U	3145	0.8	K20TT	IK20TT	IK20TT	4
1.4 (F402)	43	C1J.7.68		07/85-08/91	W20EPR-U	3047	0.8	W20TT	IW20TT	IW20TT	4
1.4 (F407) CAT	43	C3J 700		08/88-03/98	Q16P-U11	3254	1.1	Q16TT	IQ16TT	IQ16TT	4

	KW								QTY		
RENAULT <i>continued</i>											
RAPID (85-98) <i>continued</i>											
1.4 (F407) CAT	43	C3J.7.00;C3J.7.02; C3J.7.60, C3J.7.62		08/88-08/94	W14EPR-U	6011	0.8	-	IW16TT	IW16TT	4
1.4 (F40D)	58	E7J 728		01/94-03/98	Q16P-U11	3254	1.1	Q16TT	IQ16TT	IQ16TT	4
1.4 (F40M)	44	C2J 784		03/86-08/91	Q16P-U11	3254	1.1	Q16TT	IQ16TT	IQ16TT	4
1.4 (F40U, F40V)	55	E7J 726		09/91-03/98	Q16P-U11	3254	1.1	Q16TT	IQ16TT	IQ16TT	4
1.6 D (F404)	40	F8M 720; F8M 730; F8M 736		03/86-08/98	DG-001		11V				4
1.9 D (F40P, F40N, F40E)	47	F8Q 646; F8Q 722; F8Q 724; F8Q 774; F8Q 776		09/91-03/98	DG-001		11V				4
1.9 D (F40R)	40	F8Q 640		09/94-03/98	DG-001		11V				4
RODEO 4 (71-81)											
0.8	25	800 01		08/71-11/81	W20FP-U	3068	0.7	WF20TT	-	-	4
RODEO 5 (81-87)											
1.1	35	688 712		11/81-12/87	W16FP-U	4019	0.7	-	-	-	4
RODEO 6 (70-81)											
0.8	25	800.02		05/70-08/73	W20EPR-U	3047	0.8	W20TT	IW20TT	IW20TT	4
1.1	35	688.10		08/73-11/81	W20EPR-U	3047	0.8	W20TT	IW20TT	IW20TT	4
SAFRANE I (92-96)											
2.0 (B540)	77	J7R 732		11/92-07/96	T20EPR-U	5032	0.8	T20TT	IT20TT	IT20TT	4
2.0 12V (B542, B54E)	97	J7R 734		04/92-07/96	K20PBR	5060	0.85	K20TT	IK20TT	IK20TT	4
2.1 dT (B546)	65	J8S 760		11/93-07/96	DG-001		11V				4
2.2 (B541)	79	J7T 762		04/92-07/96	T20EPR-U	5032	0.8	T20TT	IT20TT	IT20TT	4
2.2 (B543)	101	J7T 760		04/92-07/96	K20PBR	5060	0.85	K20TT	IK20TT	IK20TT	4
2.5 dT (B548)	83	S8U 762; S8U 763		12/92-07/96	DG-001		11V				4
3.0 Biturbo 4x4 (B545)	193	Z7X 726		02/93-07/96	K22PBR-S	5062	0.85	-	-	VK22	6
3.0 V6 (B54B, B544)	123	Z7X 721; Z7X 722; Z7X 723; Z7X 753		12/92-07/96	K20PBR-S10	5061	1.0	K20TT	IK20TT	IK20TT	6
SAFRANE II (96-00)											
2.0 16V (B54L)	100	N7Q 710; N7Q 711		07/96-12/00	K20PBR-S10	5061	1.0	K20TT	IK20TT	IK20TT	4
2.2 dT (B54G)	83	G8T 740		07/96-12/00	DG-101		11V				4
2.5 20V (B54F)	121	N7U 700; N7U 701		07/96-12/00	K20PR-U	3145	0.8	K20TT	IK20TT	IK20TT	5
2.9 24V (B54N)	140	L7X 713		03/99-12/00	PK20PR11	3168	1.1	K20TT	IK20TT	IK20TT	6
3.0 V6 (B54M)	123	Z7X 755		07/96-12/00	K20PBR	5060	0.85	K20TT	IK20TT	IK20TT	6
SANDERO (Stepway) (07-)											
1.4	55	K7J 710		02/09-	K20PR-U	3145	0.8	K20TT	IK20TT	IK20TT	4
1.6	64/ 75/ 76	K7M 710		12/07-	K20PR-U	3145	0.8	K20TT	IK20TT	IK20TT	4
1.6	62	K7M 718		11/10-	K20TXR	5063	1.0	K20TT	IK20TT	IK20TT	4
SCÉNIC I (99-03)											
1.4 16V (JA0D, JA1H, Ja0W, JA10)	70	K4J 714; K4J 750		09/99-08/03	K20TXR	5063	1.0	K20TT	IK20TT	IK20TT	4
1.6	75/79	K4M 700; K4M 706; K4M 708; K4M 709		09/99-09/03	K20PR-U	3145	0.8	K20TT	IK20TT	IK20TT	4
1.6 BiFuel	79	K4M 704		09/99-04/01	VK20	5604	1.1	-	IK20TT	IK20TT	4
1.8 16V (JA12, JA1R, JA1M, JA1A)	85	F4P 720; F4P 722		01/01-08/03	K20PR-U	3145	0.8	K20TT	IK20TT	IK20TT	4
1.8 4x4	85	F4P 722		07/00-04/01	K20PR-U	3145	0.8	K20TT	IK20TT	IK20TT	4
1.9 D	47	F8Q 790		09/99-03/01	DG-112		11V				4
1.9 dCi (JA05, JA1F)	75	F9Q 732; F9Q 733		09/99-08/03	DG-005		11V				4
1.9 dCi RX4	74/75	F9Q 732; F9Q 740; F9Q 748; F9Q 796		11/00-08/03	DG-005		11V				4
1.9 dTi (JA0N)	72	F9Q 731, F9Q 736		09/99-08/03	DG-005		11V				4
1.9 dTi (JA0N)	72	F9Q 734		09/99-08/03	DG-101		11V				4
1.9 dTi (JA1U)	59	F9Q 744		02/01-08/03	DG-005		11V				4
2.0 16V	103	F4R.7.46;F4R.7.47		09/99-08/03	K20PR-U	3145	0.8	K20TT	IK20TT	IK20TT	4
2.0 16V (JA1B, JA1D)	102	F4R.7.40;F4R.7.41; F4R.7.46, F4R.7.47		07/00-08/03	K20PR-U	3145	0.8	K20TT	IK20TT	IK20TT	4
2.0 16V RX4	102	F4R.7.44		06/00-08/03	K20PR-U	3145	0.8	K20TT	IK20TT	IK20TT	4
SCÉNIC II (03-)											
1.4 (JM0B, JM0H, JM1A)	72	K4J.7.30(98);K4J.7.4 0(98)		06/03-09/06	K20PR-U	3145	0.8	K20TT	IK20TT	IK20TT	4
1.5 dCi (JM02, JM13)	74	K9K 728; K9K 729		11/03-	DG-005		11V				4
1.5 dCi (JM0F)	60	K9K 722		06/03-	DG-005		11V				4
1.5 dCi (JM16)	76	K9K 734		01/07-	DG-005		11V				4
1.5 dCi (JM1E)	78	K9K 732		05/05-	DG-005		11V				4
1.5 dCi (JM1F)	63	K9K 724		05/05-	DG-005		11V				4
1.6	77	K4M.7.64	Flexible fuel	06/06-07/06	K20PR-U	3145	0.8	K20TT	IK20TT	IK20TT	4
1.6 (JM0C, JM0J, JM1B)	83	K4M 761; K4M 782		06/03-12/05	K20PR-U	3145	0.8	K20TT	IK20TT	IK20TT	4







	KW				Standard 			Twin Tip 			QTY
RENAULT <i>continued</i>											
SCÉNIC II (03-) <i>continued</i>											
1.6 16V (JM1R)	82	K4M.8.12;K4M.8.13		10/05-07/08	K20PR-U	3145	0.8	K20TT	IK20TT	IK20TT	4
1.9 D	85	F9Q 812; F9Q J 803		06/06-	DG-005		11V				4
1.9 dCi	92	F9Q 804		06/03-	DG-005		11V				4
1.9 dCi (JM0G, JM12, JM1G, JM2C)	88	F9Q 812		06/03-	DG-005		11V				4
1.9 dCi (JM14)	96	F9Q 804; F9Q 816; F9Q 818; F9Q J 803		05/05-	DG-005		11V				4
1.9 dCi (JM15)	81	F9Q 804		05/05-	DG-005		11V				4
2.0 (JM05, JM0U, JM1N, JM1U, JM2V)	99	F4R 770; F4R 771		06/03-09/06	K20PR-U	3145	0.8	K20TT	IK20TT	IK20TT	4
2.0 16V Turbo (JM0W)	120	F4R 776		05/04-07/08	K20PR-U	3145	0.8	K20TT	IK20TT	IK20TT	4
SCÉNIC III (09-)											
1.5 dCi	63/70/78/81	K9K 830; K9K 832; K9K 836; K9K 837; K9K 846		04/09-	DG-609		4.4V				4
1.6 16V (JZ0U)	81	K4M 858		02/09-	K20PR-U	3145	0.8	K20TT	IK20TT	IK20TT	4
1.6 E85 (JZ03)	81	K4M 866	Flexible fuel	02/09-	K20PR-U	3145	0.8	K20TT	IK20TT	IK20TT	4
1.9 dCi	96	F9Q 870; F9Q 872		02/09-	DG-619		4.4V				4
2.0 16V (JZ0G, JZ1E)	103	M4R 710; M4R 711		02/09-	FXE20HR11	3439	1.1	-	IXEH20TT	IXEH20TT	4
SPORT Spider (95-99)											
2.0	108	F7R 710		12/95-08/96	K20PBR	5060	0.85	K20TT	IK20TT	IK20TT	4
2.0 16V	110	F7R 710		03/95-10/99	K20PBR	5060	0.85	K20TT	IK20TT	IK20TT	4
SUPER 5 (84-96)											
1.0 (B/C/400)	30	C1C 700		10/84-10/88	W20EPR-U	3047	0.8	W20TT	IW20TT	IW20TT	4
1.0 (S400)	30	C1C 700		10/84-06/87	W20EPR-U	3047	0.8	W20TT	IW20TT	IW20TT	4
1.1	35	C1E.7.60		10/89-12/90	W14EPR-U	6011	0.8	-	IW16TT	IW16TT	4
1.1 (B/C/401)	34	C1E.7.50;C1E.7.52		10/84-10/88	W20EPR-U	3047	0.8	W20TT	IW20TT	IW20TT	4
1.1 (B/C/401, B/C40H)	33	C1E.7.56		06/87-08/90	W14EPR-U	6011	0.8	-	IW16TT	IW16TT	4
1.1 (B/C/401, B/C40H)	33	C1E.7.54		01/86-06/89	W20EPR-U	3047	0.8	W20TT	IW20TT	IW20TT	4
1.1 (S401)	34	C1E.7.60		06/88-01/91	W14EPR-U	6011	0.8	-	IW16TT	IW16TT	4
1.1 (S401)	34	C1E.7.50		10/84-05/88	W20EPR-U	3047	0.8	W20TT	IW20TT	IW20TT	4
1.2 (B/C40F)	40	C1G.7.22		03/90-08/90	W14EPR-U	6011	0.8	-	IW16TT	IW16TT	4
1.2 (B/C40F)	40	C1G.7.02;C1G.7.20		01/87-08/90	W20EPR-U	3047	0.8	W20TT	IW20TT	IW20TT	4
1.2 (S40F, S407)	44	C1G.7.20;C3J.7.60		01/87-12/96	W20EPR-U	3047	0.8	W20TT	IW20TT	IW20TT	4
1.4 (B/C/407) CAT	43	C3J.7.00;C3J.7.02; C3J.7.60		10/85-12/96	W20EPR-U	3047	0.8	W20TT	IW20TT	IW20TT	4
1.4 (B/C402)	43	C1J.7.68;C1J.7.80		10/84-06/88	W20EPR-U	3047	0.8	W20TT	IW20TT	IW20TT	4
1.4 (B/C403)	52	C2J.7.00;C2J.7.80; C2J.7.81, C2J.7.88, C2J.7.89, C2J.7.98		10/84-07/89	W20EPR-U	3047	0.8	W20TT	IW20TT	IW20TT	4
1.4 (B/C40J)	49	C2J.7.82;C2J.7.89		06/87-07/89	W20EPR-U	3047	0.8	W20TT	IW20TT	IW20TT	4
1.4 (B/C40M)	44	C2J.7.84		06/87-08/90	W20EPR-U	3047	0.8	W20TT	IW20TT	IW20TT	4
1.4 Turbo (C405)	88	C1J.7.82;C1J.7.84; C1J.7.88		04/85-08/90	IW24	5316	0.7	-	-	-	4
1.6 D	40	F8M 730		04/85-12/90	DG-001		11V				4
1.6 D (B/C/404)	40	F8M 720; F8M 730		08/85-12/96	DG-001		11V				4
1.6 D (S404)	40	F8M 720		10/84-12/96	DG-001		11V				4
1.7	66	F2N.7.40		09/88-09/90	W24EPR-U	4136	0.8	-	-	-	4
1.7 (B/C408)	54	F3N 716; F3N 717		10/86-08/90	W20EPR-U	3047	0.8	W20TT	IW20TT	IW20TT	4
1.7 (B/C40K, B/C40G)	64	F2N.7.40;F2N.7.42		06/87-08/90	W24EPR-U	4136	0.8	-	-	-	4
1.7 i (C409)	69	F3N.7.02		10/86-08/91	W24EPR-U	4136	0.8	-	-	-	4
THALIA I (98-)											
1.2	43	D7F 744; D7F 746		02/98-10/03	XE20HR-U9	3427	0.9	-	IXEH20TT	IXEH20TT	4
1.2 16V	55	D4F 712		04/02-	XE20HR-U9	3427	0.9	-	IXEH20TT	IXEH20TT	4
1.4	55	K7J 700		08/00-	K20TXR	5063	1.0	K20TT	IK20TT	IK20TT	4
1.4 16V	72	K4J 712		08/00-	K20TXR	5063	1.0	K20TT	IK20TT	IK20TT	4
1.5 dCi	47/48/50/60	K9K 700; K9K 702; K9K 714; K9K 740		06/01-	DG-005		11V				4
1.6	66	K7M 746		03/98-	K20TXR	5063	1.0	K20TT	IK20TT	IK20TT	4
1.6 16V	79	K4M 740		04/02-09/08	K20PR-U	3145	0.8	K20TT	IK20TT	IK20TT	4
1.9 D	48	F8Q.630		02/98-05/01	DG-008		11V				4
THALIA II (08-)											
1.2 16V (LU2V)	55	D4F 728		09/08-	XE20HR-U9	3427	0.9	-	IXEH20TT	IXEH20TT	4
1.5 dCi	47/48/62	K9K 700; K9K 718; K9K 740		09/08-	DG-005		11V				4
1.6 16V	77	K4M 743		09/08-	K20PR-U	3145	0.8	K20TT	IK20TT	IK20TT	4
THALIA III (13-)											
1.5 dCi	66			12/13-	DG-609		4.4V				4

	KW					Standard		Twin Tip		QTY	
RENAULT <i>continued</i>											
TRAFIC (80-89)											
1.4	35	847 700; C1J 700		03/80-04/89	W20EPR-U	3047	0.8	W20TT	IW20TT	IW20TT	4
1.6	48	841 705		03/80-06/86	W16EP-U	3018	0.8	W16TT	IW16TT	IW16TT	4
1.6	48	A1M 707		01/83-06/86	W20EPR-U	3047	0.8	W20TT	IW20TT	IW20TT	4
1.6 4x4	48	A1M 707		03/80-08/86	W20EPR-U	3047	0.8	W20TT	IW20TT	IW20TT	4
1.7	50	F1N 724		06/86-04/89	W22EP-U	3085	0.8	W22TT	-	VW22	4
1.7	50	F1N 722; F1N 724		06/86-04/89	W24EPR-U	4136	0.8	-	-	-	4
2.0	59/60	J5R 716; J5R 726		03/80-04/89	W20EPR-U	3047	0.8	W20TT	IW20TT	IW20TT	4
2.0 4x4	59/60	J5R 716; J5R 726		05/85-04/89	W20EPR-U	3047	0.8	W20TT	IW20TT	IW20TT	4
2.1 D	43/44	852 720; 852 750; J8S 750		03/80-04/89	DG-001		11V				4
2.1 D 4x4	43	852 750		05/85-04/89	DG-001		11V				4
2.5 D	51	Sofim-8140.61.240		03/80-04/89	DG-001		11V				4
2.5 D	51	S8U 720;S8U 722		03/80-04/89	DG-004		11.5V				4
TRAFIC (89-01)											
1.4	35	C1J 700		05/89-06/91	W20EPR-U	3047	0.8	W20TT	IW20TT	IW20TT	4
1.7	50	F1N 720		08/92-08/94	W22EP-U	3085	0.8	W22TT	-	VW22	4
1.7	50/51	F1N 722; F1N 724; F1N.7.20		03/89-08/94	W24EPR-U	4136	0.8	-	-	-	4
1.9 D	44	F8Q 606		06/97-03/01	DG-008		11V				4
2.0	59/60	J5R 716; J5R 726		03/89-12/91	W20EPR-U	3047	0.8	W20TT	IW20TT	IW20TT	4
2.0 [RWD]	59	J5R 726		05/89-10/97	W20EPR-U	3047	0.8	W20TT	IW20TT	IW20TT	4
2.1 D	43/47	852 720; 852 750; J8S 620; J8S 758		05/89-10/97	DG-001		11V				4
2.1 D [RWD]	43/47	852 720; J8S 620; J8S 758		05/89-10/97	DG-001		11V				4
2.2	70	J7T 780		05/89-06/94	T20EPR-U	5032	0.8	T20TT	IT20TT	IT20TT	4
2.2	70/74	J7T 600; J7T 780		05/89-04/98	T20EP-U	5031	0.8	T20TT	IT20TT	IT20TT	4
2.2 4x4	70/74	J7T 600; J7T 780		05/89-04/98	T20EP-U	5031	0.8	T20TT	IT20TT	IT20TT	4
2.5 D	55/56	S8U 750; Sofim-8140.67.2580		03/89-03/01	DG-001		11V				4
2.5 D	51/55	S8U 720; S8U 758		05/89-03/01	DG-004		11.5V				4
2.5 D 4x4	55	S8U 750; S8U 752; Sofim-8140.67.2500		05/89-03/01	DG-001		11V				4
2.5 D 4x4	55	S8U 750;S8U 752		08/89-03/01	DG-004		11.5V				4
TRAFIC II (01-)											
1.9 dCi	59	F9Q 762		04/01-07/03	DG-005		11V				4
1.9 dCi 100 (EL0C)	74	F9Q 760		03/01-	DG-005		11V				4
1.9 dCi 100 (FL0C)	74	F9Q 760		03/01-	DG-005		11V				4
1.9 dCi 100 (JL0C)	74	F9Q 760		03/01-	DG-005		11V				4
1.9 dCi 80 (EL0B)	60	F9Q 762		03/01-	DG-005		11V				4
1.9 dCi 80 (FL0B)	60	F9Q 760; F9Q 762		03/01-	DG-005		11V				4
1.9 dCi 80 (JL0B)	60	F9Q 762		03/01-	DG-005		11V				4
2.0 (EL0A)	88	F4R.7.20;F4R.8.20(1 20)		03/01-	PK20PR-P8	3245	0.8	-	IK20TT	IK20TT	4
2.0 (FL0A)	88	F4R.7.20		03/01-07/06	PK20PR-P8	3245	0.8	-	IK20TT	IK20TT	4
2.0 (JL0A)	88	F4R.7.20		03/01-07/06	PK20PR-P8	3245	0.8	-	IK20TT	IK20TT	4
2.0 16V	86	F4R 820		08/06-	PK20PR-P8	3245	0.8	-	IK20TT	IK20TT	4
2.5 dCi 115	84	G9U 630		02/08-	DG-126		11V				4
2.5 dCi 135 (EL0D)	99	G9U 730		03/01-	DG-126		11V				4
2.5 dCi 135 (FL0D)	99	G9U 730		05/03-	DG-126		11V				4
2.5 dCi 135 (JL0D)	99	G9U 730		05/03-	DG-126		11V				4
2.5 dCi 145 (EL0J)	107	G9U 630		08/06-	DG-126		11V				4
2.5 dCi 145 (FL0J)	107	G9U 630		08/06-	DG-126		11V				4
2.5 dCi 145 (JL0J)	107	G9U 630		08/06-	DG-126		11V				4
TWINGO I (93-)											
1.2	44	D7F 702; D7F 703; D7F 704		09/98-08/00	K16TNR-S9	3329	0.9	K16TT	IK16TT	IK16TT	4
1.2 (C063, C064)	40	C3G 700; C3G 702		03/93-10/96	W16EP-U	3018	0.8	W16TT	IW16TT	IW16TT	4
1.2 (C066, C068)	43	D7F 700; D7F 701; D7F 702; D7F 703; D7F 704		05/96-	K16TNR-S9	3329	0.9	K16TT	IK16TT	IK16TT	4
1.2 (C067)	40	D7F 700; D7F 701		05/96-	K16TNR-S9	3329	0.9	K16TT	IK16TT	IK16TT	4
1.2 (S063, S064)	40	C3G 700; C3G 702		03/93-05/96	W16EP-U	3018	0.8	W16TT	IW16TT	IW16TT	4
1.2 (S066, S068)	43	D7F 700; D7F 701; D7F 702; D7F 703; D7F 704; D7F 706		05/96-	K16TNR-S9	3329	0.9	K16TT	IK16TT	IK16TT	4
1.2 16V (C060)	44	D4F 708		08/04-06/07	XE20HR-U9	3427	0.9	-	IXEH20TT	IXEH20TT	4
1.2 16V (C06C, C06D, C06K)	55	D4F 702		01/01-	XE20HR-U9	3427	0.9	-	IXEH20TT	IXEH20TT	4
1.2 LPG	44	D7F 702; D7F 708		10/03-05/07	K16TNR-S9	3329	0.9	K16TT	IK16TT	IK16TT	4

	KW				Standard			Twin Tip			QTY
											
RENAULT <i>continued</i>											
TWINGO II (07-)											
1.2 (CN0D)	43	D7F 800		03/07-	K20TXR	5063	1.0	K20TT	IK20TT	IK20TT	4
1.2 16V (CN04, CN0A, CN0B)	55	D4F 764; D4F 770; D4F 772		03/07-	XE20HR-U9	3427	0.9	-	IXEH20TT	IXEH20TT	4
1.2 16V (CN0K, CN0V)	56	D4F 772		03/07-	XE20HR-U9	3427	0.9	-	IXEH20TT	IXEH20TT	4
1.5 dCi (CN0E)	47	K9K 740		03/07-	DG-005		11V				4
1.5 dCi (CN0U)	62	K9K 718		04/08-	DG-005		11V				4
1.5 dCi 75	55	K9K 820		10/10-	DG-609		4.4V				4
1.5 dCi 90	63	K9K 820		10/10-	DG-609		4.4V				4
1.6 RS (CN0N, CN0R, CN0S)	98	K4M 854		05/08-	PK20PR-P8	3245	0.8	-	IK20TT	IK20TT	4
1.6 RS (CN0N, CN0R, CN0S)	98	K4M 854	OEM Optional	05/08-	VK22	5610	0.8	-	-	VK22	4
VEL SATIS (02-)											
2.0 16 V Turbo	125	F4R.7.66		04/04-	PK20PR-P8	3245	0.8	-	IK20TT	IK20TT	4
2.0 16V Turbo (BJ0K)	120	F4R.7.62;F4R.7.63; F4R.7.64, F4R.7.65, F4R.7.67, F4R.7.67(170)		06/02-	PK20PR-P8	3245	0.8	-	IK20TT	IK20TT	4
2.2 dCi	83			12/04-	DG-126		11V				4
2.2 dCi (BJ0E, BJ0F)	110	G9T 702; G9T 703		06/02-	DG-126		11V				4
2.2 dCi (BJ0E, BJ0F, BJ0G, BJ0H)	102	G9T 600; G9T 606; G9T 607; G9T 700; G9T 702		09/04-	DG-126		11V				4
2.2 dCi (BJ0H)	85	G9T 600		04/04-	DG-126		11V				4
3.0 dCi (BJ0J, BJ0N)	130	P9X 701		06/02-	DG-312		11V				6
3.0 dCi (BJ0S)	133	P9X 715		06/06-	DG-312		11V				6
3.5 (BJ01)	170	V4Y 715		10/04-	VKH16	5617	1.1	-	IKH16TT	IKH16TT	6
3.5 V6 (BJ0R, BJ0V, BJ0U)	177	V4Y 701; V4Y 711		06/02-	VKH16	5617	1.1	-	IKH16TT	IKH16TT	6
WIND (10-)											
1.6 (E4MB, E4MC)	98	K4M 854		07/10-	PK20PR-P8	3245	0.8	-	IK20TT	IK20TT	4
1.6 (E4MB, E4MC)	98	K4M 854	OEM Optional	07/10-	VK22	5610	0.8	-	-	VK22	4
RENAULT SAMSUNG											
QM5 (06-)											
2.5	126	2TR 702		12/06-	FXE20HR11	3439	1.1	-	IXEH20TT	IXEH20TT	4
2.5 4x4	126	2TR 702		12/06-	FXE20HR11	3439	1.1	-	IXEH20TT	IXEH20TT	4
RENAULT TRUCKS											
MASCOTT (99-10)											
90	63	8140.63.2585		01/99-12/01	DG-004		11.5V				4
90.35	63	8140.63.2585		01/99-12/01	DG-004		11.5V				4
120.35 (A00100003, A01100003)	85	DXi 3; ZD3 A 600		05/04-12/10	DG-605		11V				4
120.35 (A02100003)	85	DXi 3; ZD3 A 600		05/04-10/10	DG-605		11V				4
130	92	8140.43.S.2585; 8140.43.S.3585		01/99-06/04	DG-001		11V				4
130.35	92	8140.43.S.2585; 8140.43.S.3585		01/99-06/04	DG-001		11V				4
160.35 (A00100013, A01100013)	115	DXi 3; ZD3 A 604		05/04-12/10	DG-605		11V				4
160.35 (A02100013)	115	DXi 3; ZD3 A 604		05/04-10/10	DG-605		11V				4
RILEY											
ELF III (63-68)											
1.0	28			03/63-10/68	W20EPR-U	3047	0.8	W20TT	IW20TT	IW20TT	4
ROLLS-ROYCE											
CORNICHE (93-02)											
6.8	165			01/93-12/00	IW16	5305	1.1	-	IW16TT	IW16TT	8
6.8 V8 Turbo	242	L 410 M1T		01/00-09/02	IW16	5305	1.1	-	IW16TT	IW16TT	8
PHANTOM (02-)											
6.75	338	N73 B68 A		08/02-	K20TXR	5063	1.0	K20TT	IK20TT	IK20TT	12
6.75 V12	338	N73 B68 A		03/06-	K20TXR	5063	1.0	K20TT	IK20TT	IK20TT	12
SILVER Seraph (98-02)											
5.4	240			03/98-09/02	KJ14CR-L11	3167	1.1	-	-	VK16	12
SILVER Spirit (90-96)											
6.8	160/180/224/250			12/90-09/96	IW16	5305	1.1	-	IW16TT	IW16TT	8
ROVER											
25 (99-05)											
1.1 16V	55	11 K4F		01/04-05/05	PK20PR-P8	3245	0.8	-	IK20TT	IK20TT	4
1.4 16V	62/76	14 K4F; 14 K4M		10/99-05/05	PK16PR-L11	3275	1.1	-	IK16TT	IK16TT	4
1.4 16V	76	14 K4F	Flexible fuel	10/99-05/05	PK20PR-L11	3142	1.1	-	IK20TT	IK20TT	4







Spark & Glow Plugs







Application Tables







	KW					Standard			Twin Tip			QTY
ROVER <i>continued</i>												
25 (99-05) <i>continued</i>												
1.6 16V	80	16 K4F		10/99-05/05	PK16PR-L11	3275	1.1	-	IK16TT	IK16TT		4
1.6 16V	80	16 K4F	Flexible fuel	10/99-05/05	PK20PR-L11	3142	1.1	-	IK20TT	IK20TT		4
1.8 16V	85/107	18 K4F; 18 K4K		10/99-05/05	PK16PR-L11	3275	1.1	-	IK16TT	IK16TT		4
1.8 16V	85/107	18 K4F; 18 K4K	Flexible fuel	10/99-05/05	PK20PR-L11	3142	1.1	-	IK20TT	IK20TT		4
2.0 iDT	74/83	20 T2N		10/99-05/05	DG-101		11V					4
45 (00-05)												
1.4	76	14 K4F		02/00-05/05	PK16PR-L11	3275	1.1	-	IK16TT	IK16TT		4
1.4	76	14 K4F	Flexible fuel	02/00-05/05	PK20PR-L11	3142	1.1	-	IK20TT	IK20TT		4
1.6	80	16 K4F		02/00-05/05	PK16PR-L11	3275	1.1	-	IK16TT	IK16TT		4
1.6	80	16 K4F	Flexible fuel	02/00-05/05	PK20PR-L11	3142	1.1	-	IK20TT	IK20TT		4
1.8	86	18 K4F		02/00-05/05	PK16PR-L11	3275	1.1	-	IK16TT	IK16TT		4
1.8	86	18 K4F	Flexible fuel	02/00-05/05	PK20PR-L11	3142	1.1	-	IK20TT	IK20TT		4
2.0 iDT	74/83	20 T2N		02/00-05/05	DG-101		11V					4
2.0 V6	110	20K6F		02/00-02/04	PK16PR-L11	3275	1.1	-	IK16TT	IK16TT		6
2.0 V6	110	20K6		03/04-05/05	PK20PR-P8	3245	0.8	-	IK20TT	IK20TT		6
75 (99-05)												
1.8	88	K 1.8		02/99-05/05	PK16PR-L11	3275	1.1	-	IK16TT	IK16TT		4
1.8	88	K 1.8	Flexible fuel	02/99-05/05	PK20PR-L11	3142	1.1	-	IK20TT	IK20TT		4
1.8 Turbo	110	18 K4G		05/03-05/05	PK16PR-L11	3275	1.1	-	IK16TT	IK16TT		4
1.8 Turbo	110	18 K4G	Flexible fuel	05/03-05/05	PK20PR-L11	3142	1.1	-	IK20TT	IK20TT		4
2.0 CDT	85	M 47 R		02/99-05/05	DG-145		11V					4
2.0 CDTi	96	204D2		02/03-05/05	DG-145		11V					4
2.0 V6	110	20 K4F		02/99-05/05	PK16PR-L11	3275	1.1	-	IK16TT	IK16TT		6
2.0 V6	110	20 K4F	Flexible fuel	02/99-05/05	PK20PR-L11	3142	1.1	-	IK20TT	IK20TT		6
2.5 V6	129/130	25 K4F; KV 6		02/99-05/05	PK16PR-L11	3275	1.1	-	IK16TT	IK16TT		6
2.5 V6	129/130	25 K4F; KV 6	Flexible fuel	02/99-05/05	PK20PR-L11	3142	1.1	-	IK20TT	IK20TT		6
100 / METRO (90-98)												
111	44	11K2D		04/94-10/97	PK20PR-P8	3245	0.8	-	IK20TT	IK20TT		4
111 C/L/S	44	11K2A;11K2B;11K2D		03/90-12/98	PK20PR-P8	3245	0.8	-	IK20TT	IK20TT		4
114	55/75	14K2D; 14K4F4		04/94-10/98	K20PR-U	3145	0.8	K20TT	IK20TT	IK20TT		4
114 D	38	TUD 3		10/92-12/94	DG-004		11.5V					4
114 GTI 16V	69/76	14K4C; 14K4F4		03/90-01/95	K20PR-U	3145	0.8	K20TT	IK20TT	IK20TT		4
114 GTI/GT 16V CAT	66	14K4D		03/90-12/92	K20PR-U	3145	0.8	K20TT	IK20TT	IK20TT		4
114 S/L/GTA	55	14K2A;14K2B;14K2D		03/90-12/98	K20PR-U	3145	0.8	K20TT	IK20TT	IK20TT		4
115 D	42	TUD 5		12/94-12/98	DG-003		11V					4
200 (RF) (95-00)												
211	44	11K2F		01/98-03/00	PK20PR-P8	3245	0.8	-	IK20TT	IK20TT		4
214 i	55	14K2D		11/95-03/96	K20PR-U	3145	0.8	K20TT	IK20TT	IK20TT		4
214 i	55	14K2F		11/95-03/00	PK20PR-P8	3245	0.8	-	IK20TT	IK20TT		4
214 Si	76	14K4F4		11/95-03/96	K20PR-U	3145	0.8	K20TT	IK20TT	IK20TT		4
214 Si	76	14K4F4	OEM Optional	11/95-03/00	PK20PR-P8	3245	0.8	-	IK20TT	IK20TT		4
216 Si	82	16K4F4		11/95-03/00	PK20PR-P8	3245	0.8	-	IK20TT	IK20TT		4
218 K Vi	107	18K16		11/95-03/00	PK20PR-P8	3245	0.8	-	IK20TT	IK20TT		4
220 D/SD	63	20 T2R		11/95-03/00	DG-101		11V					4
220 SDi	77	20 T2N		11/95-03/00	DG-101		11V					4
200 (Xh) (85-89)												
213 S	54	EV		09/85-09/89	W20EPR-U11	3049	1.1	W20TT	IW20TT	IW20TT		4
216	61	H16A;H16B		03/85-09/89	K20PR-U	3145	0.8	K20TT	IK20TT	IK20TT		4
216 Vitesse	75	H16B-EFI		03/85-09/89	K20PR-U	3145	0.8	K20TT	IK20TT	IK20TT		4
200 (XW) (89-99)												
214	55	14K2D		09/93-10/95	K20PR-U	3145	0.8	K20TT	IK20TT	IK20TT		4
214 GSi/Si	70/76	14K4C; 14K4F4		01/90-10/95	K20PR-U	3145	0.8	K20TT	IK20TT	IK20TT		4
214 Si/Gsi	66	14K2D;14K4D		10/89-09/92	K20PR-U	3145	0.8	K20TT	IK20TT	IK20TT		4
216	90	D16A8		10/92-03/96	K20PR-U	3145	0.8	K20TT	IK20TT	IK20TT		4
216 GSi	82/85	D16A7;D16Z2;D16Z2		10/89-10/95	K20PR-U	3145	0.8	K20TT	IK20TT	IK20TT		4
216 GTi	90/96	D16A8;D16Z2;D16A9		09/90-10/95	K20PR-U	3145	0.8	K20TT	IK20TT	IK20TT		4
218 D	52			09/91-10/95	DG-001		11V					4
218 TD	65	XUD 7TE		09/91-10/95	DG-001		11V					4
220 GSi	100	20T4H		05/94-03/96	K20PR-U	3145	0.8	K20TT	IK20TT	IK20TT		4
220 GTi	100/103	20M4F; 20T4H		09/91-10/95	K20PR-U	3145	0.8	K20TT	IK20TT	IK20TT		4
220 Turbo	147	20T4G		10/92-03/96	K20PR-U	3145	0.8	K20TT	IK20TT	IK20TT		4







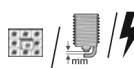

Spark & Glow Plugs











Application Tables







	KW				Standard 			Twin Tip 			QTY
ROVER continued											
400 (90-98)											
1.6 i	82/90	D16Z2		05/94-04/95	K20PR-U	3145	0.8	K20TT	IK20TT	IK20TT	4
1.8 i	107	18K4K		06/96-10/97	PK16PR-L11	3275	1.1	-	IK16TT	IK16TT	4
1.8 i	107	18K4K	Flexible fuel	06/96-10/97	PK20PR-L11	3142	1.1	-	IK20TT	IK20TT	4
1.8 TD	65	XUD 7TE		09/93-11/98	DG-001		11V				4
2.0 i	100	20T4H		05/94-04/95	K20PR-U	3145	0.8	K20TT	IK20TT	IK20TT	4
414	70	14K4F4		01/93-04/95	K20PR-U	3145	0.8	K20TT	IK20TT	IK20TT	4
414 GSI/SI	66	14K4C;14K4D		04/90-09/92	K20PR-U	3145	0.8	K20TT	IK20TT	IK20TT	4
414 GSI/SI CAT	76	14K4F4		01/93-04/95	K20PR-U	3145	0.8	K20TT	IK20TT	IK20TT	4
416 GSI	82	D16A7;D16Z2		04/90-04/95	K20PR-U	3145	0.8	K20TT	IK20TT	IK20TT	4
416 GSI/GSE	85	D16A7;D16Z2		04/90-04/95	K20PR-U	3145	0.8	K20TT	IK20TT	IK20TT	4
416 GTI	90	D16A8		04/90-09/92	K20PR-U	3145	0.8	K20TT	IK20TT	IK20TT	4
416 GTI/GTE	96	D16A9		04/90-09/92	K20PR-U	3145	0.8	K20TT	IK20TT	IK20TT	4
418 D	49			09/91-04/95	DG-001		11V				4
418 TD	65	XUD 7TE		09/91-04/95	DG-001		11V				4
420 GSI/SLI/GTI/Vite	100	20T4H		01/93-04/95	K20PR-U	3145	0.8	K20TT	IK20TT	IK20TT	4
420 GTI/GSI/Vitesse	103	20M4F		02/92-09/92	K20PR-U	3145	0.8	K20TT	IK20TT	IK20TT	4
420 Turbo	147	20T4G		01/93-04/95	K20PR-U	3145	0.8	K20TT	IK20TT	IK20TT	4
400 (95-00)											
414 Si	76	14K4F4		05/95-03/00	PK20PR-P8	3245	0.8	-	IK20TT	IK20TT	4
416 Si	83	D16Y3E		05/95-03/00	K20PR-U11	3121	1.1	K20TT	IK20TT	IK20TT	4
416 Si	82/83	16K4F4		05/95-03/00	PK20PR-P8	3245	0.8	-	IK20TT	IK20TT	4
416 Si	85	D16B2		05/95-03/00	Q20PR-U11	3008	1.1	Q20TT	IQ20TT	IQ20TT	4
420 D	63	20 T2R		11/95-03/00	DG-101		11V				4
420 Di	77	20 T2N		05/95-03/00	DG-101		11V				4
420 Si Lux	100	20T4H		12/95-03/00	PK20PR-P8	3245	0.8	-	IK20TT	IK20TT	4
600 (93-99)											
618 i/Si	85	F18A3		03/96-02/99	KJ20CR-L11	3169	1.1	K20TT	IK20TT	IK20TT	4
620 i	85	F20Z2		08/93-06/96	KJ20CR-L11	3169	1.1	K20TT	IK20TT	IK20TT	4
620 Sdi	77	20 T2N		12/94-02/99	DG-101		11V				4
620 Si	96	F20Z1		08/93-02/99	KJ20CR-L11	3169	1.1	K20TT	IK20TT	IK20TT	4
620 Ti Vitesse	147	20T4G		07/94-02/99	PK20PR-P8	3245	0.8	-	IK20TT	IK20TT	4
623 Si	116	H23A3		08/93-02/99	KJ20CR-L11	3169	1.1	K20TT	IK20TT	IK20TT	4
800 (86-99)											
2.5	129	25KV6F-175		02/96-10/98	K20PR-U	3145	0.8	K20TT	IK20TT	IK20TT	6
2.5 Si	129	25KV6F-175		02/96-10/98	K20PR-U	3145	0.8	K20TT	IK20TT	IK20TT	6
820 16 V I/SI (XS)	103	M16I		10/86-10/88	K20PR-U	3145	0.8	K20TT	IK20TT	IK20TT	4
820 16V Turbo (RS)	132	20T4G;20T4GG		01/92-02/99	K20PR-U	3145	0.8	K20TT	IK20TT	IK20TT	4
820 I/SI (RS)	100	20T4H		01/92-02/99	K20PR-U	3145	0.8	K20TT	IK20TT	IK20TT	4
820 I/SI (XS)	100/ 103	20T4H; M16E;M16I		10/88-02/99	K20PR-U	3145	0.8	K20TT	IK20TT	IK20TT	4
820 Sport	145	20T4G		04/94-03/96	K20PR-U	3145	0.8	K20TT	IK20TT	IK20TT	4
825 D/SD (XS)	87	425 SL1RR; 492 4 SHIRG		12/91-04/95	DG-001		11V				4
825 D/SD (XS)	87	425 SL1RR; 492 4 SHIRG		05/95-02/99	DG-109		11V				4
825 D/SD (XS)	87	425 SL1RR; 492 4 SHIRG		01/90-11/91	DG-202		11V				4
825 SD	87	425 SL1RR; 492 4 SHIRG		09/93-04/95	DG-001		11V				4
825 SD	87	425 SL1RR; 492 4 SHIRG		05/95-02/99	DG-109		11V				4
825 Si (RS)	129	25KV6F-175		04/96-02/99	K20PR-U	3145	0.8	K20TT	IK20TT	IK20TT	6
825 Si Lux (RS)	129	25KV6F-175		04/96-02/99	K20PR-U	3145	0.8	K20TT	IK20TT	IK20TT	6
825 Si/Sterling (XS)	123/ 127	C25A2		10/86-10/88	K20PR-U	3145	0.8	K20TT	IK20TT	IK20TT	6
825 Si/Sterling (XS) CAT	110	C25A2		10/86-02/88	K20PR-U	3145	0.8	K20TT	IK20TT	IK20TT	6
827 Si/Sterling (XS)	130	20M4G;C27A2		02/88-12/91	K20PR-U	3145	0.8	K20TT	IK20TT	IK20TT	6
827 Si/Sterling (XS) CAT	124	C27A1		02/88-09/91	K20PR-U	3145	0.8	K20TT	IK20TT	IK20TT	6
827 Vitesse (XS) CAT	124	C27A1		10/88-12/91	K20PR-U	3145	0.8	K20TT	IK20TT	IK20TT	6
827 Vitesse/SLI	130	20M4G;C27A2		10/88-12/91	K20PR-U	3145	0.8	K20TT	IK20TT	IK20TT	6
2000-3500 (76-86)											
2000	74	20V973		10/82-10/86	T20EPR-U	5032	0.8	T20TT	IT20TT	IT20TT	4
2400 TD	67	HR 492 HT		05/82-10/86	DG-202		11V				4
CABRIOLET (90-99)											
214 1.4	66/70	14K4C; 14K4D		01/92-09/92	K20PR-U	3145	0.8	K20TT	IK20TT	IK20TT	4
214 1.4i 16V	76	14K4F4		01/93-03/96	K20PR-U	3145	0.8	K20TT	IK20TT	IK20TT	4
216 1.6i	90	D16A8		01/92-03/96	K20PR-U	3145	0.8	K20TT	IK20TT	IK20TT	4
216 1.6i 16V	82	16K4F4;D16Z2		01/96-11/99	K20PR-U	3145	0.8	K20TT	IK20TT	IK20TT	4





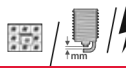

	KW					Standard			Twin Tip			QTY
ROVER <i>continued</i>												
COUPE (96-99)												
1.6 16 V	82	16K4F4		03/96-11/99	K20PR-U	3145	0.8		K20TT	IK20TT	IK20TT	4
1.8 16 V	107	18K4K		03/96-11/99	PK20PR-P8	3245	0.8		-	IK20TT	IK20TT	4
MAESTRO (90-95)												
1.3	49/51	12HE;12HF		09/90-01/95	W20EP-U	3043	0.8		W20TT	IW20TT	IW20TT	4
1.6	63	16H		09/90-04/92	K20PR-U	3145	0.8		K20TT	IK20TT	IK20TT	4
2.0 D	44			09/90-10/92	DG-001		11V					4
2.0 TD	60	BB		09/90-01/95	DG-001		11V					4
MINI (91-01)												
1.3	63			11/96-05/01	W20EPR-U	3047	0.8		W20TT	IW20TT	IW20TT	4
1.3 Cooper S	59			06/95-11/00	W20EPR-U	3047	0.8		W20TT	IW20TT	IW20TT	4
1.3 S	46	12 A2L		02/98-05/01	W20EPR-U	3047	0.8		W20TT	IW20TT	IW20TT	4
1000	30	99 HD 81		01/92-06/93	W20EPR-U	3047	0.8		W20TT	IW20TT	IW20TT	4
1300	37/ 39/ 45/ 46	12 A2A; 12 A2B; 12 A2D; 12 A2E; 12 A2L		10/92-11/00	W20EPR-U	3047	0.8		W20TT	IW20TT	IW20TT	4
1300 / Cooper	45	12 A2A		06/91-02/94	W20EPR-U	3047	0.8		W20TT	IW20TT	IW20TT	4
MINI-Moke (86-)												
1.0	29	99H		09/86-08/90	W16EPR-U	3021	0.8		W16TT	IW16TT	IW16TT	4
MONTEGO (84-95)												
2.0 D Turbo	60	BB		10/88-10/95	DG-001		11V					4
2.0 GTi	86	20HA;20HB59; 20HB60		10/88-10/91	W20EPR-U	3047	0.8		W20TT	IW20TT	IW20TT	4
2.0 GTi/LXi	75	20HA30/B43		12/90-12/93	W20EP-U	3043	0.8		W20TT	IW20TT	IW20TT	4
2.0 i CAT	75	20HA30;20HB43		12/90-01/92	W20EP-U	3043	0.8		W20TT	IW20TT	IW20TT	4
2.0 Turbo-D	60	BB		01/93-12/93	DG-001		11V					4
STREETWISE (03-05)												
1.4	62/76	14 K4F; 14 K4M	Ch: >471564	08/03-05/05	PK20PR-P8	3245	0.8		-	IK20TT	IK20TT	4
1.4	62/76	14 K4F; 14 K4M	Ch: 471565>	08/03-05/05	PK16PR-L11	3275	1.1		-	IK16TT	IK16TT	4
1.6	80	16 K4F	Ch: >471564	01/04-05/05	PK20PR-P8	3245	0.8		-	IK20TT	IK20TT	4
1.6	80	16 K4F	Ch: 471565>	01/04-05/05	PK16PR-L11	3275	1.1		-	IK16TT	IK16TT	4
1.8	86	18K4	Ch: 471565>	08/03-05/05	KJ20CR-L11	3169	1.1		K20TT	IK20TT	IK20TT	4
1.8	86	18K4	Flexible fuel	08/03-05/05	PK20PR-L11	3142	1.1		-	IK20TT	IK20TT	4
2.0 TD	74	20 T2N		08/03-05/05	DG-101		11V					4
SAAB												
9-3 (98-03)												
2.0 i	96	B204I		02/98-12/00	IQ16	5301	1.1		-	IQ16TT	IQ16TT	4
2.0 SE Turbo	147	B204R		02/98-01/99	Q22PR-U11	3257	1.1		-	-	VQ22	4
2.0 Turbo	110/ 113/ 151	B204E; B205E; B205R-205		10/99-08/03	PQ20R	3117	1.1		Q20TT	IQ20TT	IQ20TT	4
2.0 Turbo	136	B204L		02/98-08/03	Q22PR-U11	3257	1.1		-	-	VQ22	4
2.0 Turbo	113	B204E	OEM Optional	10/98-01/99	Q22PR-U11	3257	1.1		-	-	VQ22	4
2.2 TiD	85	D223L; X 22 DTH		02/98-11/00	DG-118		11V					4
2.2 TiD	92	D223L		11/00-09/02	DG-142		11V					4
2.3 i	110	B234I(149)		02/98-12/00	IQ20	5302	1.1		-	IQ20TT	IQ20TT	4
2.3 Turbo	165	B235R(224)		10/98-08/03	Q22PR-U11	3257	1.1		-	-	VQ22	4
9-3 (02-)												
1.8t	110	B207E		09/02-	PK20PR-L11	3142	1.1		-	IK20TT	IK20TT	4
1.8 i	90	Z18XE		03/05-01/09	KJ16CR-L11	3132	1.1		K16TT	IK16TT	IK16TT	4
1.8 t	110	B207E		03/05-01/06	PK20PR-L11	3142	1.1		-	IK20TT	IK20TT	4
1.9 TiD	88/ 110	Z 19 DTH		03/05-	DG-170		11V					4
1.9 TiD	88	Z 19 DT	Ch: >72045139;75030986;78007391	09/04-	DG-122		11V					4
1.9 TiD	88	Z 19 DT	Ch: 72045140;75030987;78007392 >	09/04-	DG-196		11V					4
1.9 TTiD	96/ 118/ 132	A 19 DTR; Z 19 DTR		12/07-	DG-608		4.4V					4
2.0 t	110/ 129/ 154	B207E; B207L; B207R		09/02-	PK20PR-L11	3142	1.1		-	IK20TT	IK20TT	4
2.0 T Bio Power XWD	154	B207R		06/08-	PK20PR-L11	3142	1.1		-	IK20TT	IK20TT	4
2.0 t BioPower	129/ 154	B207L; B207R		09/02-12/07	K22PR-U11	3192	1.1		-	-	VK22	4









	KW								QTY
SAAB continued									
9-3 (02-) continued									
2.0 t BioPower	129/154	B207L; B207R		01/08-	PK20PR-L11	3142 1.1	-	IK20TT	4
2.0 T BioPower XWD	154	B207R		01/08-	PK20PR-L11	3142 1.1	-	IK20TT	4
2.0 T XWD	154	B207R		06/08-	PK20PR-L11	3142 1.1	-	IK20TT	4
2.0 Turbo XWD	154	B207R		01/08-	PK20PR-L11	3142 1.1	-	IK20TT	4
2.2 TiD	92	D223L		09/02-	DG-142	11V			4
2.8 Turbo V6	188	B284L		12/07-08/08	IKH20	5344 1.1	-	IKH20TT	6
9-3X (09-)									
1.9 TTiD	132	Z 19 DTR		02/09-	DG-142	11V			4
2.0 T BioPower XWD	154	B207R		02/09-	PK20PR-L11	3142 1.1	-	IK20TT	4
2.0 T XWD	154	B207R		02/09-	PK20PR-L11	3142 1.1	-	IK20TT	4
9-5 (97-)									
1.9 TiD	110	Z 19 DTH		01/06-	DG-170	11V			4
2.0 t	110	B205E; B205E-D4; B205E-E2		09/01-02/07	PQ20R	3117 1.1	Q20TT	IQ20TT	4
2.0 t	110	B205E		09/97-08/01	Q20PR-U11	3008 1.1	Q20TT	IQ20TT	4
2.0 t	136/141	B205R	Ch: >X047592	10/98-	Q22PR-U11	3257 1.1	-	VQ22	4
2.0 t	136/141	B205R	Ch: X047593>	10/98-	Q20PR-U11	3008 1.1	Q20TT	IQ20TT	4
2.0 t Biopower	162	A 20 NFT		01/09-	ITV16	5338 1.1	-	ITV16TT	4
2.0 t BioPower	110/132	B205E		01/05-	PQ20R	3117 1.1	Q20TT	IQ20TT	4
2.0 Turbo SE	141	B205R	Ch: >X047592	10/98-07/00	Q22PR-U11	3257 1.1	-	VQ22	4
2.0 Turbo SE	141	B205R	Ch: X047593>	10/98-07/00	Q20PR-U11	3008 1.1	Q20TT	IQ20TT	4
2.2 TiD	88	D223L		03/02-	DG-118	11V			4
2.3 t	136	B235E		01/01-	PQ20R	3117 1.1	Q20TT	IQ20TT	4
2.3 t	125	B235E	Ch: >X047592	09/97-	Q22PR-U11	3257 1.1	-	VQ22	4
2.3 t	125/136	B235E	Ch: X047593>	09/97-08/01	Q20PR-U11	3008 1.1	Q20TT	IQ20TT	4
2.3 t	125	B235E	Ch: OEM Optional, > X047592	10/98-	Q22PR-U11	3257 1.1	-	VQ22	4
2.3 t BioPower	136	B235E		01/07-	PQ20R	3117 1.1	Q20TT	IQ20TT	4
2.3 Turbo	191	B235R(260)		11/05-07/09	PK22PR-L11S	3284 1.1	-	VK22G	4
2.3 Turbo	162/184/191	B235L; B235L-D4; B235L-E2; B235R(260); B235R; B235R-D4; B235R-E2		07/03-	PQ20R	3117 1.1	Q20TT	IQ20TT	4
2.3 Turbo	169	B235R(230)	Ch: Y086667>	10/99-09/01	PQ20R	3117 1.1	Q20TT	IQ20TT	4
2.3 Turbo	169	B235R(230)	Ch: OEM Optional, > Y086666	10/99-09/01	PK22PR-L11S	3284 1.1	-	VK22G	4
3.0 TiD	130	D308L		07/01-08/05	DG-312	11V			6
3.0 V6t	147	B308E		01/98-08/03	K22PR-U11	3192 1.1	-	VK22	6
9-5 (10-)									
1.6 Turbo	132	A16LET		05/10-	IK20L	5358 1.1	-	IK20TT	4
2.0 T BioPower	162	A 20 NFT		05/10-	ITV16	5338 1.1	-	ITV16TT	4
2.0 T BioPower XWD	162	A 20 NHT		05/10-	ITV20	5339 1.1	-	ITV20TT	4
2.0 TiD	118	A 20 DTH		05/10-	DG-608	4.4V			4
2.0 TTiD	140	A 20 DTR		05/10-	DG-608	4.4V			4
2.0 TTiD XWD	140	A 20 DTR		05/10-	DG-608	4.4V			4
2.0 Turbo	162	A 20 NHT		05/10-	ITV20	5339 1.1	-	ITV20TT	4
2.0 Turbo XWD	162	A 20 NHT		05/10-	ITV20	5339 1.1	-	ITV20TT	4
9-7X (05-)									
5.3	220	Vortec 5 300		12/05-05/08	IT16	5325 1.1	-	IT16TT	8
5.3	220	Vortec5300GPL; Vortec 5 300 Bi	Flexible fuel	12/05-05/08	VT16	5621 1.1	-	IT16TT	8
90 (84-87)									
2.0	74	B201C; SAAB02		08/84-08/87	W20EPR-U11	3049 1.1	W20TT	IW20TT	4
99 (68-84)									
2.0 GL	74	B20C; B20T		10/80-01/83	W20EPR-U11	3049 1.1	W20TT	IW20TT	4
900 I (78-94)									
2.0 -16	93	B202I		01/89-12/93	IQ16	5301 1.1	-	IQ16TT	4
2.0 -16	93	B202I		01/90-06/94	Q20P-U	3125 0.8	Q20TT	IQ20TT	4
2.0 8V Turbo	114	B201S		01/88-01/89	IW22	5307 0.8	-	VW22	4
2.0 c	74	B 20		09/79-12/88	W20EP-U	3043 0.8	W20TT	IW20TT	4









	KW					Standard			Twin Tip		QTY
SAAB <i>continued</i>											
900 I (78-94) <i>continued</i>											
2.0 EMS	87	BI 20		09/78-12/80	W20EP-U	3043	0.8	W20TT	IW20TT	IW20TT	4
2.0 i	85	BI 20		11/80-08/90	W20EP-U	3043	0.8	W20TT	IW20TT	IW20TT	4
2.0 S Turbo-16	104/ 107	B202S		07/91-12/93	IQ22	5313	0.8	-	-	VQ22	4
2.0 Turbo	103/ 110	B201S		01/86-01/89	IW22	5307	0.8	-	-	VW22	4
2.0 Turbo	107	BSI 20		09/78-07/85	W22EP-U	3085	0.8	W22TT	-	VW22	4
2.0 Turbo-16 S	129	B202L; B202XL		01/84-12/88	IQ22	5313	0.8	-	-	VQ22	4
2.0 Turbo-16 S	129	B202L		02/84-07/84	K22PR-U	3165	0.8	-	-	VK22	4
900 II (93-98)											
2.0 -16 Turbo	136	B204L		07/93-02/98	Q22PR-U11	3257	1.1	-	-	VQ22	4
2.0 i	96/98	B204I; B206I		12/93-02/98	IQ16	5301	1.1	-	IQ16TT	IQ16TT	4
2.0 i	96	B204I		12/93-02/98	Q20PR-U11	3008	1.1	Q20TT	IQ20TT	IQ20TT	4
2.3 -16	110	B234I(149); B234I		12/93-02/98	IQ20	5302	1.1	-	IQ20TT	IQ20TT	4
2.3 -16	110	B234I		07/93-02/98	Q20PR-U11	3008	1.1	Q20TT	IQ20TT	IQ20TT	4
2.5 -24 V6	125	B258I		07/93-02/98	K20TXR	5063	1.0	K20TT	IK20TT	IK20TT	6
9000 (84-98)											
2.0	99	B202I		10/88-08/90	Q20PR-U11	3008	1.1	Q20TT	IQ20TT	IQ20TT	4
2.0 -16	92/94	B202I; B202XI		12/85-12/88	Q20PR-U11	3008	1.1	Q20TT	IQ20TT	IQ20TT	4
2.0 -16 CD	96/ 110	B202I; B202S; B204E; B204I; B204S		09/93-12/98	Q20PR-U11	3008	1.1	Q20TT	IQ20TT	IQ20TT	4
2.0 -16 CS	94/96	B202I; B204I		01/89-12/98	Q20PR-U11	3008	1.1	Q20TT	IQ20TT	IQ20TT	4
2.0 -16 ND Turbo	110	B202S; B204E; B204S		09/93-12/98	Q22PR-U	3010	0.8	-	-	VQ22	4
2.0 -16 Turbo	118/ 120/ 127/ 129	B202L; B202XL		04/85-08/93	Q22PR-U	3010	0.8	-	-	VQ22	4
2.0 -16 Turbo CD	108/ 120/ 136	B202L; B202S; B202XL; B204E		09/89-12/98	Q22PR-U	3010	0.8	-	-	VQ22	4
2.0 -16 Turbo CS	136	B202L		09/88-12/98	Q22PR-U	3010	0.8	-	-	VQ22	4
2.0 16v	143	B202L		09/89-01/90	Q22PR-U	3010	0.8	-	-	VQ22	4
2.0 Carlsson	143	B204L		09/89-08/90	Q22PR-U	3010	0.8	-	-	VQ22	4
2.0 T16	150	B202L		06/89-10/90	Q22PR-U	3010	0.8	-	-	VQ22	4
2.3	110	B234I		10/89-12/93	Q20PR-U11	3008	1.1	Q20TT	IQ20TT	IQ20TT	4
2.3	165	B234R		09/90-10/98	Q22PR-U11	3257	1.1	-	-	VQ22	4
2.3 -16 Aero CS	162/ 165	B234R		02/93-12/98	Q22PR-U11	3257	1.1	-	-	VQ22	4
2.3 -16 CD	107	B234I		08/89-12/98	Q20PR-U11	3008	1.1	Q20TT	IQ20TT	IQ20TT	4
2.3 -16 CD Turbo	147	B234L		07/90-12/98	Q22PR-U11	3257	1.1	-	-	VQ22	4
2.3 -16 CDE	108	B234I		09/93-12/98	Q20PR-U11	3008	1.1	Q20TT	IQ20TT	IQ20TT	4
2.3 -16 CDE Eco-Power	125	B234E		09/93-12/98	Q22PR-U11	3257	1.1	-	-	VQ22	4
2.3 -16 CS	107	B234I		09/89-12/98	Q20PR-U11	3008	1.1	Q20TT	IQ20TT	IQ20TT	4
2.3 -16 CSE	108	B234I		09/93-12/98	Q20PR-U11	3008	1.1	Q20TT	IQ20TT	IQ20TT	4
2.3 -16 Turbo	143	B234L		09/90-12/98	Q22PR-U11	3257	1.1	-	-	VQ22	4
2.3 -16 Turbo CSE	147	B234L		09/93-12/98	Q22PR-U11	3257	1.1	-	-	VQ22	4
3.0 -24 V6 CD/CDE	155	B308I		07/94-12/98	K20TXR	5063	1.0	K20TT	IK20TT	IK20TT	6
3.0 -24 V6 CS/CSE	155	B308I		07/94-12/98	K20TXR	5063	1.0	K20TT	IK20TT	IK20TT	6
SANTANA											
LANDROVER 88 / 109 (71-91)											
2.3	52	11H		10/71-10/83	W20ESR-U	3057	0.8	-	-	-	4
SAMURAI (86-95)											
1.0	33	F10A		09/89-12/95	W16EXR-U	3031	0.8	W16TT	IW16TT	IW16TT	4
1.3	47			09/86-12/94	W20EPR-U	3047	0.8	W20TT	IW20TT	IW20TT	4
SEAT											
131 (78-86)											
2.0	85	131 C4.000		06/78-12/85	W22EPR-U	3088	0.8	W22TT	-	VW22	4
132 (73-82)											
2.0 D	40			05/73-12/80	DG-001		11V				4
2.2 D	44	OM 615.912		05/79-12/82	DG-001		11V				4
ALHAMBRA (7V) (96-10)											
1.8 T 20V	110	AJH		10/97-05/00	K20PBR-S10	5061	1.0	K20TT	IK20TT	IK20TT	4
1.8 T 20V	110	AWC		06/00-03/10	PK20PR-P8	3245	0.8	-	IK20TT	IK20TT	4
1.9 TDI	81	AFN; AVG		08/96-06/00	DG-005		11V				4
1.9 TDI	96/ 110	ASZ; BTB		11/02-11/08	DG-109		11V				4
1.9 TDI	66/85	1Z; AHU; ANU; AUJ; BVK	Ch: >7M-2-514 000	04/96-03/10	DG-005		11V				4
1.9 TDI	66/85	1Z; AHU; ANU; AUJ; BVK	Ch: 7M-2-514 001>	04/96-03/10	DG-109		11V				4







	KW										QTY
SEAT <i>continued</i>											
ALHAMBRA (7V) (96-10) <i>continued</i>											
1.9 TDI 4motion	85	AUY; BVK	Ch: >7M-2-514 000	06/00-03/10	DG-005		11V				4
1.9 TDI 4motion	85	AUY; BVK	Ch: 7M-2-514 001>	06/00-03/10	DG-109		11V				4
1.9 Tdi 4x4	96	ASZ		06/05-11/08	DG-109		11V				4
2.0 i	85	ADY; ATM		04/96-03/10	K20PBR-S10	5061	1.0	K20TT	IK20TT	IK20TT	4
2.8 V6	150	AYL		06/00-03/10	PKJ16CR-L11	3246	1.1	-	IK16TT	IK16TT	6
2.8 V6	150	AUE	50000km Lifetime, IridiumTough	06/00-04/02	VK16	5603	1.1	-	IK16TT	IK16TT	6
2.8 V6 4motion	150	AYL		06/00-03/10	PKJ16CR-L11	3246	1.1	-	IK16TT	IK16TT	6
2.8 V6 4motion	150	AUE	50000km Lifetime, IridiumTough	06/00-04/02	VK16	5603	1.1	-	IK16TT	IK16TT	6
ALHAMBRA (710) (10-)											
2.0 TDI	85/ 100/ 103/ 125	CFFA; CFFB; CFFE; CFGB		06/10-	DG-193		4.4V				4
2.0 TDI 4Drive	103	CFFB		05/11-	DG-193		4.4V				4
2.0 TSI	147	CCZA		11/10-	PK22PR8	3273	0.8	-	-	VK22	4
ALTEA (XL) (5P) (04-)											
1.4 16V	63	BXW		05/06-	KJ20DR-M11	3374	1.1	-	IK20TT	IK20TT	4
1.4 TSI	92	CAXC		11/07-	PKJ20CR8	3173	0.8	-	-	VK20G	4
1.6	75	BGU; BSE; BSF; CCSA; CMXA		03/04-	K20PBR-S10	5061	1.0	K20TT	IK20TT	IK20TT	4
1.6 LPG	75	CHGA		09/09-	K20PBR-S10	5061	1.0	K20TT	IK20TT	IK20TT	4
1.6 Multifuel	75	CCSA		10/06-	K20PBR-S10	5061	1.0	K20TT	IK20TT	IK20TT	4
1.6 TDI	66/77	CAYB; CAYC		10/09-	DG-193		4.4V				4
1.8 TFSI	118	BYT; BZB; CDA		01/07-	PK22PR8	3273	0.8	-	-	VK22	4
1.9 TDI	66/77	BJB; BKC; BLS; BXE; BXF		10/06-	DG-177		5V				4
2.0 FSI	110	BLY; BVZ		05/04-03/09	K20PR-U	3145	0.8	K20TT	IK20TT	IK20TT	4
2.0 FSI	110	BLR; BVY		05/04-03/09	VKA16	5622	1.1	-	-	VKA16	4
2.0 TDI	103	BMM		05/10-	DG-177		5V				4
2.0 TDI	100	AZV		03/04-05/09	DG-190		4.4V				4
2.0 TDI	125	CEGA		03/06-	DG-193		4.4V				4
2.0 TDI 16V	103	BKD		03/04-	DG-190		4.4V				4
2.0 TDI 4x4	103	BMM		05/10-	DG-177		5V				4
2.0 TDI 4x4	125	CEGA; CFJA		06/07-	DG-193		4.4V				4
2.0 TFSI	147	BWA		04/06-05/09	PK22PR8	3273	0.8	-	-	VK22	4
2.0 TFSI 4x4	147/ 155	BWA; CCZB		06/07-	PK22PR8	3273	0.8	-	-	VK22	4
AROSA (6H) (97-04)											
1.0	37	AHT		10/98-01/01	K20PBR-S10	5061	1.0	K20TT	IK20TT	IK20TT	4
1.0	37	AER		05/97-06/04	W20EPBR-S	5067	0.85	W20TT	IW20TT	IW20TT	4
1.4	44	AEX		05/97-06/04	W20EPBR-S	5067	0.85	W20TT	IW20TT	IW20TT	4
1.4 16V	74	AQQ		01/00-06/04	K20PBR-S10	5061	1.0	K20TT	IK20TT	IK20TT	4
1.4 TDI	55	AMF	Ch: >6H-2-009 700	01/00-06/04	DG-005		11V				3
1.4 TDI	55	AMF	Ch: 6H-2-009 701>	01/00-06/04	DG-109		11V				3
1.7 SDI	44	AKU		08/97-06/04	DG-005		11V				4
CORDOBA (6K1) (93-99)											
1.0 i	37	AER		09/96-06/99	W20EPBR-S	5067	0.85	W20TT	IW20TT	IW20TT	4
1.4 i	44	AEX; APQ		06/94-06/99	W20EPBR-S	5067	0.85	W20TT	IW20TT	IW20TT	4
1.4 i 16V	74	AFH		09/96-06/99	K20PBR-S10	5061	1.0	K20TT	IK20TT	IK20TT	4
1.6 i	74	AFT		07/96-10/99	K20PBR-S10	5061	1.0	K20TT	IK20TT	IK20TT	4
1.6 i	55	1F; ABU; AEE		05/94-06/99	W20EPBR-S	5067	0.85	W20TT	IW20TT	IW20TT	4
1.7 SDI	44	AKU		07/97-06/99	DG-005		11V				4
1.8 i	66	ADZ		02/93-06/99	W20EPBR-S	5067	0.85	W20TT	IW20TT	IW20TT	4
1.8 i 16V	95	ADL		10/93-08/96	K22PBR-S	5062	0.85	-	-	VK22	4
1.9 D	47/50	1Y		02/93-08/96	DG-012		11V				4
1.9 SDI	47	AEY		08/96-06/99	DG-005		11V				4
1.9 TD	55	AAZ		02/93-08/96	DG-012		11V				4
1.9 TDI	66/81	1Z; AFN; AHU		08/96-06/99	DG-005		11V				4
2.0 i	85	2E		02/93-06/99	K22PBR-S	5062	0.85	-	-	VK22	4
2.0 i 16V	110	ABF		08/96-06/99	PK22PR8	3273	0.8	-	-	VK22	4
CORDOBA (6K2) (99-02)											
1.0	37	AUC		06/99-10/02	PKJ16CR-L11	3246	1.1	-	IK16TT	IK16TT	4
1.4	44	AUD		06/99-12/02	PKJ16CR-L11	3246	1.1	-	IK16TT	IK16TT	4
1.4 16V	55/74	APE; AUB		02/00-10/02	K20PBR-S10	5061	1.0	K20TT	IK20TT	IK20TT	4







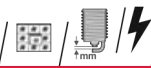



	KW								QTY		
SEAT <i>continued</i>											
CORDOBA (6K2) (99-02) <i>continued</i>											
1.6	74	AKL; AUR		06/99-12/02	K20PBR-S10	5061	1.0	K20TT	IK20TT	IK20TT	4
1.6	55	ALM		06/99-12/02	W20EPBR-S	5067	0.85	W20TT	IW20TT	IW20TT	4
1.8 T 20V Cupra	115	AQX		07/00-10/02	PK20PR-P8	3245	0.8	-	IK20TT	IK20TT	4
1.9 SDI	50	AGP; AQM		06/99-12/02	DG-005		11V				4
1.9 TDI	66/81	AGR; AHU; ALH; ASK; ASV		06/99-12/02	DG-005		11V				4
CORDOBA (6L) (02-09)											
1.2	47	AZQ; BME		10/02-06/06	KJ16CR-L11	3132	1.1	K16TT	IK16TT	IK16TT	3
1.2 12V	51	BBV		05/06-11/09	PK20PR-P8	3245	0.8	-	IK20TT	IK20TT	3
1.4 16V	55/74	BBY; BBZ; BKY		09/02-11/09	K20PBR-S10	5061	1.0	K20TT	IK20TT	IK20TT	4
1.4 16V	63	BXW		05/06-11/09	KJ20DR-M11	3374	1.1	-	IK20TT	IK20TT	4
1.4 16V	55	BBY	OEM Optional	09/02-04/04	PKJ16CR-L11	3246	1.1	-	IK16TT	IK16TT	4
1.4 TDI	51/ 55/ 59	AMF; BMS; BNM; BNV		05/05-11/09	DG-109		11V				3
1.6 16V	77	BTS		11/06-11/09	KJ20DR-M11	3374	1.1	-	IK20TT	IK20TT	4
1.9 SDI	47	ASY		09/02-11/09	DG-109		11V				4
1.9 TDI	74/96	ASZ; ATD; AXR; BLT		09/02-11/09	DG-109		11V				4
2.0	85	AZL; BBX		09/02-11/09	K20PBR-S10	5061	1.0	K20TT	IK20TT	IK20TT	4
EXEO (3R) (08-)											
1.6	75	ALZ		03/09-09/10	K20PBR-S10	5061	1.0	K20TT	IK20TT	IK20TT	4
1.6	75	ALZ	OEM Optional	03/09-09/10	PK20PR-P8	3245	0.8	-	IK20TT	IK20TT	4
1.8 T	110	CFMA		12/08-05/10	K20PBR-S10	5061	1.0	K20TT	IK20TT	IK20TT	4
1.8 T	110	CFMA	OEM Optional	12/08-05/10	PK20PR-P8	3245	0.8	-	IK20TT	IK20TT	4
1.8 TSI	88/ 118	CDHA; CDHB		05/10-	PK22PR8	3273	0.8	-	-	VK22	4
2.0 TDI	88/ 105/ 125	CAGA; CAGC; CAHA; CGLB; CJCA; CJCC		12/08-	DG-193		4.4V				4
2.0 TFSI	147/ 155	BWE; CDND		03/09-	PK22PR8	3273	0.8	-	-	VK22	4
FURA (82-86)											
0.9	29/ 31/ 33	100 GL 7000; HB 90		01/82-12/86	W20EPR-U	3047	0.8	W20TT	IW20TT	IW20TT	4
IBIZA I (84-93)											
0.9	29/32	146 A 000		08/86-05/93	W20EPR-U	3047	0.8	W20TT	IW20TT	IW20TT	4
1.2	44/47	021 A 1000		11/84-12/93	Q22P-U	3255	0.8	-	-	VQ22	4
1.2 i	52	021 C.1000		01/89-05/93	Q22P-U	3255	0.8	-	-	VQ22	4
1.5	63	021 A 2000		11/84-05/93	Q22P-U	3255	0.8	-	-	VQ22	4
1.5 i	65	021 D.2000		10/86-05/93	Q22PR-U	3010	0.8	-	-	VQ22	4
1.5 i	74	021 B.2000		03/88-05/93	Q22P-U	3255	0.8	-	-	VQ22	4
1.5 i CAT	66	021 C.2000		10/86-05/93	Q22P-U	3255	0.8	-	-	VQ22	4
1.7	72	021 A.3000		02/92-05/93	Q22P-U	3255	0.8	-	-	VQ22	4
1.7 D	40/42	022 A.5000		06/84-05/93	DG-001		11V				4
IBIZA II (6K1) (93-99)											
1.0	33	AAU		03/93-09/96	W20EPBR-S	5067	0.85	W20TT	IW20TT	IW20TT	4
1.0 i	37	AER		09/96-08/99	W20EPBR-S	5067	0.85	W20TT	IW20TT	IW20TT	4
1.3 i	40	AAV		03/93-08/99	W20EPBR-S	5067	0.85	W20TT	IW20TT	IW20TT	4
1.4 i	44	ABD		09/93-08/99	W20EPBR-S	5067	0.85	W20TT	IW20TT	IW20TT	4
1.4 i 16V	74	AFH		06/97-08/99	K20PBR-S10	5061	1.0	K20TT	IK20TT	IK20TT	4
1.6 i	74	AFT		04/96-08/99	K20PBR-S10	5061	1.0	K20TT	IK20TT	IK20TT	4
1.6 i	55	1F; ABU		03/93-08/99	W20EPBR-S	5067	0.85	W20TT	IW20TT	IW20TT	4
1.7 SDI	44			07/97-08/99	DG-005		11V				4
1.8 i	66	ADZ		03/93-08/99	W20EPBR-S	5067	0.85	W20TT	IW20TT	IW20TT	4
1.8 i 16V	95	ADL		11/93-08/96	K22PBR-S	5062	0.85	-	-	VK22	4
1.9 D	47/50	1Y		04/93-08/96	DG-012		11V				4
1.9 SDI	47	AEY		08/96-08/99	DG-005		11V				4
1.9 TD	55	AAZ		03/93-08/96	DG-012		11V				4
1.9 TDI	66/81	1Z; AFN; AHU		08/96-08/99	DG-005		11V				4
2.0 i	85	AGG		03/93-08/99	W20EPBR-S	5067	0.85	W20TT	IW20TT	IW20TT	4
2.0 i 16V	110	ABF		08/96-08/99	PK22PR8	3273	0.8	-	-	VK22	4
IBIZA III (6K2) (99-02)											
1.0	37	ALD; ANV; AUC		08/99-02/02	PKJ16CR-L11	3246	1.1	-	IK16TT	IK16TT	4
1.0 16V	51	AST; AVZ		10/99-02/02	W22EPR-U	3088	0.8	W22TT	-	VW22	4
1.4	44	AKK; ANW; AUD		08/99-02/02	PKJ16CR-L11	3246	1.1	-	IK16TT	IK16TT	4
1.4 16V	55/74	APE; AQQ; AUA; AUB		08/99-02/02	K20PBR-S10	5061	1.0	K20TT	IK20TT	IK20TT	4
1.6	74	AEH; AKL; APF; AUR		08/99-02/02	K20PBR-S10	5061	1.0	K20TT	IK20TT	IK20TT	4
1.6	55	ALM		08/99-02/02	W20EPBR-S	5067	0.85	W20TT	IW20TT	IW20TT	4







	KW				Standard 			Twin Tip 			QTY
SEAT <i>continued</i>											
IBIZA III (6K2) (99-02) <i>continued</i>											
1.8 T 20V Cupra	115	AQX; AYP		07/00-02/02	K20PBR-S10	5061	1.0	K20TT	IK20TT	IK20TT	4
1.9 SDI	50	AGP; AQM		08/99-02/02	DG-005		11V				4
1.9 TDI	66/81	AGR; ALH; ASK; ASV		08/99-02/02	DG-005		11V				4
IBIZA IV (6L) (02-09)											
1.2	44/47	AZQ; BBM; BME		02/02-05/08	KJ16CR-L11	3132	1.1	K16TT	IK16TT	IK16TT	3
1.2 12V	51	BXV		05/06-11/09	KJ16CR-L11	3132	1.1	K16TT	IK16TT	IK16TT	3
1.4 16V	55/74	AUB; BBY; BBZ; BKY		02/02-11/09	K20PBR-S10	5061	1.0	K20TT	IK20TT	IK20TT	4
1.4 16V	63	BXW		05/06-11/09	KJ20DR-M11	3374	1.1	-	IK20TT	IK20TT	4
1.4 16V	55	BBY; BKY	OEM Optional	02/02-12/07	PKJ16CR-L11	3246	1.1	-	IK16TT	IK16TT	4
1.4 TDI	51/59	BNM; BNV		05/05-11/09	DG-109		11V				3
1.4 TDI	55	AMF	Ch: >6L-2-001 500	05/02-12/05	DG-005		11V				3
1.4 TDI	55	AMF	Ch: 6L-2-001 501>	05/02-12/05	DG-109		11V				3
1.6 16V	77	BTS		11/06-11/09	KJ20DR-M11	3374	1.1	-	IK20TT	IK20TT	4
1.8 T Cupra R	132	BBU; BLZ		01/04-02/08	PK20PR-P8	3245	0.8	-	IK20TT	IK20TT	4
1.8 T FR	110	BJX; BKV		12/03-05/08	PK20PR-P8	3245	0.8	-	IK20TT	IK20TT	4
1.9 SDI	47	ASY		02/02-12/05	DG-005		11V				4
1.9 TDI	74/96	ASZ; ATD; AXR; BLT	Ch: >6L-2-001 500	02/02-11/09	DG-005		11V				4
1.9 TDI	74/96	ASZ; ATD; AXR; BLT	Ch: 6L-2-001 501>	02/02-11/09	DG-109		11V				4
1.9 TDI Cupra R	118	BPX; BUK	Ch: >6L-2-001 500	03/04-02/08	DG-005		11V				4
1.9 TDI Cupra R	118	BPX; BUK	Ch: 6L-2-001 501>	03/04-02/08	DG-109		11V				4
2.0	85	AZL; BBX		04/02-06/07	K20PBR-S10	5061	1.0	K20TT	IK20TT	IK20TT	4
IBIZA V (6J) (08-)											
1.2	44/51	BZG; CGPA; CGPB; CJLB		07/08-	KJ20DR-M11	3374	1.1	-	IK20TT	IK20TT	3
1.2 TDI	55	CFWA		04/10-	DG-193		4.4V				3
1.4	63	BXW; CGGB		03/08-	KJ20DR-M11	3374	1.1	-	IK20TT	IK20TT	4
1.4 TDI	59	BMS		07/08-06/10	DG-193		4.4V				3
1.4 TSI	110	CAVF		06/09-02/11	PKJ20CR8	3173	0.8	-	-	VK20G	4
1.4 TSI	110	CAVF		02/11-	SKJ20CR-A8	3371	0.8	-	-	-	4
1.4 TSI Cupra	132	CAVE; CTHE		06/09-02/11	PKJ20CR8	3173	0.8	-	-	VK20G	4
1.4 TSI Cupra	132	CAVE; CTHE		02/11-	SKJ20CR-A8	3371	0.8	-	-	-	4
1.6	77	BTS		07/08-	KJ20DR-M11	3374	1.1	-	IK20TT	IK20TT	4
1.6 LPG	60	CNKA		05/11-	KJ20DR-M11	3374	1.1	-	IK20TT	IK20TT	4
1.6 TDI	55/66/77	CAYA; CAYB; CAYC; CLNA		05/09-	DG-193		4.4V				4
1.9 TDI	66/77	BLS; BXJ		07/08-06/10	DG-177		5V				4
2.0	85	CEKA		10/08-	K20PBR-S10	5061	1.0	K20TT	IK20TT	IK20TT	4
2.0 TDI	105	CFHD		01/10-	DG-193		4.4V				4
INCA (6K9) (95-03)											
1.4 16V	55	AUA		04/00-06/03	K20PBR-S10	5061	1.0	K20TT	IK20TT	IK20TT	4
1.4 i	44	AUD		11/95-06/03	PKJ16CR-L11	3246	1.1	-	IK16TT	IK16TT	4
1.6 i	55	1F; AEE		11/95-09/00	W20EPBR-S	5067	0.85	W20TT	IW20TT	IW20TT	4
1.7 D	42	AHB		09/96-06/03	DG-005		11V				4
1.9 D	47	1Y		11/95-06/03	DG-012		11V				4
1.9 SDI	47	AEY; AYQ		11/95-06/03	DG-005		11V				4
1.9 TDI	66	ALH		09/96-06/03	DG-005		11V				4
LEON (1M) (99-06)											
1.4 16V	55	AHW - Eu3; APE; AXP; BCA		11/99-06/06	K20PBR-S10	5061	1.0	K20TT	IK20TT	IK20TT	4
1.6	74/75	AEH; AKL; BFQ		11/99-06/06	K20PBR-S10	5061	1.0	K20TT	IK20TT	IK20TT	4
1.6 16 V	77	BCB		09/00-06/06	K20PBR-S10	5061	1.0	K20TT	IK20TT	IK20TT	4
1.6 16 V	77	AZD; BCB		09/00-06/06	PKJ16CR-L11	3246	1.1	-	IK16TT	IK16TT	4
1.8 20V	92	AGN; APG		11/99-06/06	K20PBR-S10	5061	1.0	K20TT	IK20TT	IK20TT	4
1.8 20V T	132	APP		11/99-06/06	K20PBR-S10	5061	1.0	K20TT	IK20TT	IK20TT	4
1.8 20V T	132	APP; AUQ	OEM Optional	11/99-06/06	PK20PR-P8	3245	0.8	-	IK20TT	IK20TT	4
1.8 20V T 4	132	AJQ; ARY; AUQ		11/99-04/04	PK20PR-P8	3245	0.8	-	IK20TT	IK20TT	4
1.8 T Cupra R	154/165	AMK; BAM		02/02-06/06	PK20PR-P8	3245	0.8	-	IK20TT	IK20TT	4
1.9 SDI	50	AQM		11/99-06/06	DG-005		11V				4
1.9 TDI	66/81	AGR; AHF; ALH; ASV		11/99-06/06	DG-005		11V				4
1.9 TDI	74	AXR		10/05-06/06	DG-109		11V				4
1.9 TDI	110	ARL	Ch: >1M-2-062 000	09/00-06/06	DG-005		11V				4

	KW					Standard			Twin Tip			QTY
SEAT <i>continued</i>												
LEON (1M) (99-06) <i>continued</i>												
1.9 TDI	96/110	ARL; ASZ	Ch: 1M-2-062 001>	09/00-06/06	DG-109		11V					4
1.9 TDI Syncro	110	ARL	Ch: >1M-2-062 000	05/02-06/06	DG-005		11V					4
1.9 TDI Syncro	110	ARL	Ch: 1M-2-062 001>	05/02-06/06	DG-109		11V					4
2.8 Cupra 4	150	BDE		02/01-04/04	PKJ16CR-L11	3246	1.1	-		IK16TT	IK16TT	6
2.8 Cupra 4	150	AUE	50000km Lifetime, IridiumTough	02/01-04/01	VK16	5603	1.1	-		IK16TT	IK16TT	6
LEON (1P) (05-)												
1.4 16V	63	BXW		06/06-05/10	KJ20DR-M11	3374	1.1	-		IK20TT	IK20TT	4
1.4 TSI	92	CAXC		11/07-	PKJ20CR8	3173	0.8	-			VK20G	4
1.6	75	BSE; BSF; CCSA; CMXA		07/05-	K20PBR-S10	5061	1.0		K20TT	IK20TT	IK20TT	4
1.6 LPG	75	CHGA		12/09-	K20PBR-S10	5061	1.0		K20TT	IK20TT	IK20TT	4
1.6 MultiFuel	75	CMXA		11/10-	K20PBR-S10	5061	1.0		K20TT	IK20TT	IK20TT	4
1.6 TDI	66/77	CAYB; CAYC		02/10-	DG-193		4.4V					4
1.8 TSI	118	BZB; CDAA		06/07-	PK22PR8	3273	0.8	-			VK22	4
1.9 TDI	66/77	BKC; BLS; BXE; BXF		07/05-	DG-177		5V					4
2.0 Cupra R	195	CDLA		09/09-05/10	PK22PR8	3273	0.8	-			VK22	4
2.0 FSI	110	BLR; BLY; BVY; BVZ		07/05-05/10	K20PR-U	3145	0.8		K20TT	IK20TT	IK20TT	4
2.0 FSI	110	BLR; BLY; BVY; BVZ	OEM Optional	07/05-05/10	VKA16	5622	1.1	-			VKA16	4
2.0 TDI	103	BMM		10/05-	DG-177		5V					4
2.0 TDI	100	AZV		07/05-05/10	DG-190		4.4V					4
2.0 TDI	125	CEGA; CFJA		05/06-	DG-193		4.4V					4
2.0 TDI 16V	103	BKD		07/05-	DG-190		4.4V					4
2.0 TDI 16V	103	CFHC; CLCB		07/05-	DG-193		4.4V					4
2.0 TFSI	136/147/155/177	BWA1; BWJ; CCZB; CDLD		09/05-05/10	PK22PR8	3273	0.8	-			VK22	4
LEON (5F) (12-)												
1.6 TDI	66/77	CLHA; CLHB		11/12-	DG-193		4.4V					4
2.0 TDI	81/105/110/135	CKFC; CRMB; CRVA; CRVC; CUNA; CUPA		05/13-	DG-193		4.4V					4
MALAGA (84-93)												
1.2	44	021 A 1000		05/85-12/93	Q22P-U	3255	0.8	-			VQ22	4
1.5	63	021 A 2000		05/85-12/93	Q22P-U	3255	0.8	-			VQ22	4
1.5 i	74	021A		01/87-12/93	Q22PR-U	3010	0.8	-			VQ22	4
1.5 i CAT	66	021 A 2000		10/86-12/93	Q22P-U	3255	0.8	-			VQ22	4
1.7 D	40/42	022 A.5000		05/85-12/93	DG-001		11V					4
MARBELLA (86-98)												
0.8	25	08 NCA		08/86-12/93	W20EPR-U	3047	0.8		W20TT	IW20TT	IW20TT	4
0.9	29/32	08 NCB; 09 NCA; 100 GL 7000		01/87-10/98	W20EPR-U	3047	0.8		W20TT	IW20TT	IW20TT	4
0.9 CAT	29/30	08 NCB; 09 NCB; 100 GL 7000		01/87-10/98	W20EPR-U	3047	0.8		W20TT	IW20TT	IW20TT	4
PANDA (80-86)												
0.9	31	100 GL 3000		10/80-12/86	W20EPR-U	3047	0.8		W20TT	IW20TT	IW20TT	4
RITMO (78-83)												
1.7 D	41	022 A.5000		10/79-09/83	DG-001		11V					4
RONDA (82-88)												
1.2	44/47	021 A 1000		08/83-12/86	Q22P-U	3255	0.8	-			VQ22	4
1.5	63	021 A 2000		09/84-12/86	Q22P-U	3255	0.8	-			VQ22	4
1.6	68	138 AR 6000		08/83-09/85	W22EP-U	3085	0.8		W22TT		VW22	4
1.7 Diesel	40/41	022 A.5000		06/82-12/86	DG-001		11V					4
TERRA (87-96)												
0.9	29	09 NCA		01/87-12/96	W20EPR-U	3047	0.8		W20TT	IW20TT	IW20TT	4
0.9 CAT	29	09 NCB		01/90-12/95	W20EPR-U	3047	0.8		W20TT	IW20TT	IW20TT	4
1.3 D	33	MN		03/90-12/94	DG-012		11V					4
1.4 D	35	1 W		10/90-12/95	DG-012		11V					4
TOLEDO I (1L) (91-99)												
1.6 i	54/74	AFT; EZ		05/91-03/99	K20PBR-S10	5061	1.0		K20TT	IK20TT	IK20TT	4
1.6 i	52/54/55	1F		05/91-03/99	W20EPBR-S	5067	0.85		W20TT	IW20TT	IW20TT	4
1.8 16V	92	PL		05/91-03/99	K20PBR	5060	0.85		K20TT	IK20TT	IK20TT	4
1.8 16V	98	KR		05/91-03/99	K22PB	5069	0.85	-			VK22	4
1.8 i	66	ADZ		11/93-12/96	W20EPBR-S	5067	0.85		W20TT	IW20TT	IW20TT	4





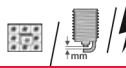

	KW									QTY	
SEAT <i>continued</i>											
TOLEDO I (1L) (91-99) <i>continued</i>											
1.8 i	65	RP		05/91-12/96	W22EPB	5066	0.85	W22TT	-	VW22	4
1.9 D	47/50	1Y		05/91-03/99	DG-012		11V				4
1.9 SDI	47	1Y		12/95-03/99	DG-012		11V				4
1.9 TD	55	AAZ		05/91-03/99	DG-012		11V				4
1.9 TDI	66/81	1Z; AFN; AHU		08/95-03/99	DG-005		11V				4
2.0 i	85	AGG		05/91-03/99	W20EPBR-S	5067	0.85	W20TT	IW20TT	IW20TT	4
2.0 i 16V	110	ABF		11/93-03/99	PK22PR8	3273	0.8	-	-	VK22	4
TOLEDO II (1M) (99-06)											
1.4 16V	55	AHW - Eu3; AXP		07/99-05/02	K20PBR-S10	5061	1.0	K20TT	IK20TT	IK20TT	4
1.6	74	AEH; AKL		04/99-09/00	K20PBR-S10	5061	1.0	K20TT	IK20TT	IK20TT	4
1.6 16V	77	AUS		09/00-04/02	K20PBR-S10	5061	1.0	K20TT	IK20TT	IK20TT	4
1.6 16V	77	AZD; BCB		09/00-07/04	PKJ16CR-L11	3246	1.1	-	IK16TT	IK16TT	4
1.8 20V	92	AGN; APG		04/99-07/04	K20PBR-S10	5061	1.0	K20TT	IK20TT	IK20TT	4
1.8 20VT	132	AUQ		05/01-07/04	PK20PR-P8	3245	0.8	-	IK20TT	IK20TT	4
1.9 SDI	50	AQM		11/99-06/04	DG-005		11V				4
1.9 TDI	66/81	AGR; AHF; ALH; ASV		04/99-05/06	DG-005		11V				4
1.9 TDI	110	ARL	Ch: >1M-2-062 000	10/00-05/06	DG-005		11V				4
1.9 TDI	96/ 110	ARL; ASZ	Ch: 1M-2-062 001>	10/00-05/06	DG-109		11V				4
2.3 V5	110	AGZ		04/99-05/01	K20TXR	5063	1.0	K20TT	IK20TT	IK20TT	5
2.3 V5 20V	125	AQN		05/01-05/06	PKJ16CR-L11	3246	1.1	-	IK16TT	IK16TT	5
TOLEDO III (5P) (04-09)											
1.6	75	BGU; BSE; BSF		10/04-05/09	K20PBR-S10	5061	1.0	K20TT	IK20TT	IK20TT	4
1.8 TFSI	118	BYT; BZB		01/07-05/09	PK22PR8	3273	0.8	-	-	VK22	4
1.9 TDI	77	BJB; BKC; BXE		10/04-05/09	DG-177		5V				4
2.0 FSI	110	BLR; BLY; BVY; BVZ		10/04-05/09	K20PR-U	3145	0.8	K20TT	IK20TT	IK20TT	4
2.0 FSI	110	BLR; BLY; BVY; BVZ	OEM Optional	10/04-05/09	VKA16	5622	1.1	-	-	VKA16	4
2.0 TDI	103	BMM		11/05-05/09	DG-177		5V				4
2.0 TDI	100	AZV		09/04-05/09	DG-190		4.4V				4
2.0 TDI	125	CEGA		01/06-05/09	DG-193		4.4V				4
2.0 TDI 16V	103	BKD		04/04-05/09	DG-190		4.4V				4
2.0 TFSI	147	BWA		11/05-05/09	PK22PR8	3273	0.8	-	-	VK22	4
TOLEDO IV (KG3) (12-)											
1.4 TSI	90	CAXA		07/12-	PKJ20CR8	3173	0.8	-	-	VK20G	4
1.6 TDI	77	CAYC; CLNA		07/12-	DG-193		4.4V				4
SHELBY											
SERIES 1 (98-)											
4.0	186			01/98-	ZT20EPR11	5087	1.1	T20TT	IT20TT	IT20TT	8
SKODA											
100 (70-77)											
1.0	29/31	OHV		01/70-12/77	W20FS-U	3073	0.7	WF20TT	-	-	4
105 / 120 (76-90)											
1.0 105 S,L	34	742,10		08/76-12/90	W20FP-U	3068	0.7	WF20TT	-	-	4
1.0 105 S,L,GL	33	742,10		08/76-08/83	W20FP-U	3068	0.7	WF20TT	-	-	4
1.2 120 L	38			08/76-12/90	W20FP-U	3068	0.7	WF20TT	-	-	4
1.2 120 LS	43	742.12 X		08/76-12/90	W20FP-U	3068	0.7	WF20TT	-	-	4
105 / 120 (83-90)											
1.0 105 S,L	32	742,10		02/88-12/90	W20FP-U	3068	0.7	WF20TT	-	-	4
1.0 105 S,L,LS	33	742,10		10/83-12/90	W20FP-U	3068	0.7	WF20TT	-	-	4
1.2 120 GLS	43	742.12 X		02/83-12/90	W20FP-U	3068	0.7	WF20TT	-	-	4
1.2 120 L	35/38	742,12		10/83-09/89	W20FPR-U	3070	0.7	WF20TT	-	-	4
110 (69-82)											
1.1 L	33/35			12/69-03/82	W20FSR-U	6053	0.7	WF20TT	-	-	4
1.1 LS	38	OHV		07/70-03/82	W20FSR-U	6053	0.7	WF20TT	-	-	4
1.1 R	38	OHV		07/70-03/82	W20FSR-U	6053	0.7	WF20TT	-	-	4
130 (85-91)											
GL (S135)	43	135/8		05/88-10/91	W22FP-U	4021	0.7	-	-	-	4
L, GL	45	742,13		02/85-10/91	W22FP-U	4021	0.7	-	-	-	4
1000 (64-70)											
MB	27/32			09/64-01/70	W16FSR	3033	0.7	-	-	-	4
MBX de Luxe	34			01/69-01/70	W16FSR	3033	0.7	-	-	-	4
1100 (69-70)											
MB	34			01/69-01/70	W16FSR	3033	0.7	-	-	-	4
FABIA (6Y) (99-08)											
1.0	37	AQV; ARV		12/99-08/02	K20PBR-S10	5061	1.0	K20TT	IK20TT	IK20TT	4
1.2	40	BMD		05/04-07/04	K20PBR-S10	5061	1.0	K20TT	IK20TT	IK20TT	3
1.2	40/47	AZQ; BMD; BME		01/03-12/07	KJ16CR-L11	3132	1.1	K16TT	IK16TT	IK16TT	3

	KW								QTY		
SKODA continued											
FABIA (6Y) (99-08) continued											
1.2	40	AWY	Eng: >3-671 670	07/01-10/02	SKJ16CR-L11	3396	1.1	-	IK16TT	IK16TT	3
1.2	40	AWY	Eng: 3-671 671>	10/02-12/07	KJ16CR-L11	3132	1.1	K16TT	IK16TT	IK16TT	3
1.2	40	AWY	Ch: >3-671 670	07/01-10/02	SKJ16CR-L11	3396	1.1	-	IK16TT	IK16TT	3
1.2	40	AWY	Ch: 3-671 671>	07/01-05/04	KJ16CR-L11	3132	1.1	K16TT	IK16TT	IK16TT	3
1.4	50	AME; AQW; ATZ		08/99-05/03	IK16	5303	1.1	-	IK16TT	IK16TT	4
1.4	44/50	AZE;AZF; AZE; AZF		04/00-05/03	K16TNR-S9	3329	0.9	K16TT	IK16TT	IK16TT	4
1.4 16V	55	BKY		08/04-03/08	KJ16CR-L11	3132	1.1	K16TT	IK16TT	IK16TT	4
1.4 16V	59	BUD		04/06-12/07	KJ20DR-M11	3374	1.1	-	IK20TT	IK20TT	4
1.4 16V	55/74	AUA; AUB; BBY; BBZ; BBZ-E4; BKY		12/99-12/07	K20PBR-S10	5061	1.0	K20TT	IK20TT	IK20TT	4
1.4 TDI	51/ 55/ 59	AMF; BNM; BNV		10/05-03/08	DG-109		11V				3
1.9 SDI	47	ASY		12/99-03/08	DG-005		11V				4
1.9 TDI	74	ATD; AXR	Ch: >6Y-2-451 087	01/00-03/08	DG-005		11V				4
1.9 TDI	74	ATD; AXR	Ch: 6Y-2-451 088>	01/00-03/08	DG-109		11V				4
1.9 TDI RS	96	ASZ; BLT		06/03-03/08	DG-109		11V				4
2.0	85	AZL		12/99-12/07	K20PBR-S10	5061	1.0	K20TT	IK20TT	IK20TT	4
FABIA (06-14)											
1.2	44/51	CGPA; CHFA		03/10-12/14	KJ20DR-M11	3374	1.1	-	IK20TT	IK20TT	3
1.2	51	BZG-E2; BZG-E4	Ch: >5J8 3074 394	10/07-03/10	KJ16CR-L11	3132	1.1	K16TT	IK16TT	IK16TT	3
1.2	51	BZG-E2; BZG-E4	Ch: 5J8 B501 226>	01/07-03/10	KJ16CR-L11	3132	1.1	K16TT	IK16TT	IK16TT	3
1.2	44	BBM	Ch: 5J8 B501 226>	12/06-03/10	KJ16CR-L11	3132	1.1	K16TT	IK16TT	IK16TT	3
1.2 12V	44	CGPB		11/11-12/14	KJ20DR-M11	3374	1.1	-	IK20TT	IK20TT	3
1.2 TDI	55	CFWA		05/10-12/14	DG-193		4.4V				3
1.4	63	BXW; CGGB		01/07-12/14	KJ20DR-M11	3374	1.1	-	IK20TT	IK20TT	4
1.4 TDI	51/59	BNM; BNV		02/07-03/10	DG-109		11V				3
1.4 TSI RS	132	CAVE; CTHE		05/10-12/14	PKJ20CR8	3173	0.8	-	-	VK20G	4
1.6	77	BTS; CFNA		04/07-12/14	KJ20DR-M11	3374	1.1	-	IK20TT	IK20TT	4
1.6 TDI	55/ 66/ 77	CAYA; CAYB; CAYC		03/10-12/14	DG-193		4.4V				4
1.9 TDI	77	BSW		04/07-03/10	DG-109		11V				4
FAVORIT (78) (89-97)											
1.3	50	136B		12/92-06/97	K20PR-U	3145	0.8	K20TT	IK20TT	IK20TT	4
1.3	40/42	135B; 781.135		12/92-06/97	Q16PR-U	3137	0.8	Q16TT	IQ16TT	IQ16TT	4
1.3 (135 E)	40	781.135E		09/91-06/95	Q16PR-U	3137	0.8	Q16TT	IQ16TT	IQ16TT	4
1.3 (135)	44	781.135		12/91-06/95	Q16PR-U	3137	0.8	Q16TT	IQ16TT	IQ16TT	4
1.3 (136)	45	OHC		08/91-08/92	Q20P-U	3125	0.8	Q20TT	IQ20TT	IQ20TT	4
1.3 (781)	50	136B		01/94-09/94	K20PR-U	3145	0.8	K20TT	IK20TT	IK20TT	4
1.3 135 (781)	42/ 43/ 44	781.135		10/90-09/94	Q16PR-U	3137	0.8	Q16TT	IQ16TT	IQ16TT	4
1.3 135 X,LX,GLX (781)	40	781.135E		01/90-09/94	Q20PR-U	3007	0.8	Q20TT	IQ20TT	IQ20TT	4
1.3 135L (781)	43	781.135		08/92-09/94	Q16PR-U	3137	0.8	Q16TT	IQ16TT	IQ16TT	4
1.3 136 (781)	45	136 L		10/90-08/92	Q20P-U	3125	0.8	Q20TT	IQ20TT	IQ20TT	4
FELICIA Fun (97-02)											
1.3	50	136M		06/97-03/01	K16PR-U	3191	0.8	K16TT	IK16TT	IK16TT	4
1.3	40	135M		06/97-04/02	Q16PR-U	3137	0.8	Q16TT	IQ16TT	IQ16TT	4
1.6	55	AEE		06/97-04/02	W20EPBR-S	5067	0.85	W20TT	IW20TT	IW20TT	4
1.9 D	47	AEF		06/97-04/02	DG-012		11V				4
FELICIA I (6U) (94-98)											
1.3	50	AMH		10/94-03/98	K20PR-U	3145	0.8	K20TT	IK20TT	IK20TT	4
1.3	40/43	AMG; AMJ		10/94-03/98	Q16PR-U	3137	0.8	Q16TT	IQ16TT	IQ16TT	4
1.3 LX	40	AMG		08/95-03/98	Q16PR-U	3137	0.8	Q16TT	IQ16TT	IQ16TT	4
1.3 LXI	50	AMH		08/95-03/98	K20PR-U	3145	0.8	K20TT	IK20TT	IK20TT	4
1.6 GLX	55	AEE		08/95-03/98	W20EPBR-S	5067	0.85	W20TT	IW20TT	IW20TT	4
1.6 LX	55	AEE		08/95-03/98	W20EPBR-S	5067	0.85	W20TT	IW20TT	IW20TT	4
1.9 D	47	AEF		10/95-03/98	DG-012		11V				4
FELICIA II (6U) (98-01)											
1.3	40/ 43/ 50	AMG; AMH		01/98-06/01	K16PR-U	3191	0.8	K16TT	IK16TT	IK16TT	4
1.6	55	AEE		01/98-06/01	W20EPBR-S	5067	0.85	W20TT	IW20TT	IW20TT	4

	KW										QTY
SKODA continued											
FELICIA II (6U) (98-01) continued											
1.9 D	47	AEF		01/98-06/01	DG-012		11V				4
OCTAVIA (1U) (96-10)											
1.4	44	AMD		04/99-03/01	K20PBR-S10	5061	1.0	K20TT	IK20TT	IK20TT	4
1.4 16V	55	AXP		09/00-12/10	K20PBR-S10	5061	1.0	K20TT	IK20TT	IK20TT	4
1.4 16V	55	BCA		08/00-12/10	PKJ16CR-L11	3246	1.1	-	IK16TT	IK16TT	4
1.6	74/75	AKL; AVU; BFQ		02/97-12/10	K20PBR-S10	5061	1.0	K20TT	IK20TT	IK20TT	4
1.6	55	AEE		09/96-09/04	W20EPBR-S	5067	0.85	W20TT	IW20TT	IW20TT	4
1.8	92	AGN		09/96-07/00	K20PBR-S10	5061	1.0	K20TT	IK20TT	IK20TT	4
1.8 20V	92	AGN		07/98-07/00	K20PBR-S10	5061	1.0	K20TT	IK20TT	IK20TT	4
1.8 T	110	AGU		08/97-12/10	PK20PR-P8	3245	0.8	-	IK20TT	IK20TT	4
1.8 T 4x4	110	AGU; AUM		05/01-05/06	PK20PR-P8	3245	0.8	-	IK20TT	IK20TT	4
1.9 SDI	50	AGP; AQM		06/97-12/03	DG-005		11V				4
1.9 TDI	66/ 74/ 81	AGR; AHF; ALH; ASV; ATD; AXR		08/97-03/10	DG-005		11V				4
1.9 TDI	74/96	ASZ; ATD; AXR		12/01-12/10	DG-109		11V				4
1.9 TDI 4x4	66/74	AGR; ATD		11/99-02/06	DG-005		11V				4
1.9 TDI 4x4	74	ATD		12/01-01/06	DG-109		11V				4
2.0	85	AEG; APK; AQY; AZH		04/99-05/07	K20PBR-S10	5061	1.0	K20TT	IK20TT	IK20TT	4
2.0	85	AZJ		04/99-05/07	PKJ16CR-L11	3246	1.1	-	IK16TT	IK16TT	4
2.0 4x4	85	AZH		08/00-09/04	K20PBR-S10	5061	1.0	K20TT	IK20TT	IK20TT	4
2.0 4x4	85/88	ATF; AZJ		01/00-12/10	PKJ16CR-L11	3246	1.1	-	IK16TT	IK16TT	4
RS 1.8 T	132	AUQ		05/01-01/06	PK20PR-P8	3245	0.8	-	IK20TT	IK20TT	4
OCTAVIA (1Z) (04-13)											
1.4	55	BCA		05/04-05/06	K20PBR-S10	5061	1.0	K20TT	IK20TT	IK20TT	4
1.4	59	BUUD; CGGA		06/04-06/13	KJ20DR-M11	3374	1.1	-	IK20TT	IK20TT	4
1.4 TSI	90	CAXA		11/08-06/13	PKJ20CR8	3173	0.8	-	-	VK20G	4
1.6	75	BGU; BSE; BSF; CCSA; CMXA		06/04-06/13	K20PBR-S10	5061	1.0	K20TT	IK20TT	IK20TT	4
1.6 FSI	85	BLF		02/04-10/08	K20PBR-S10	5061	1.0	K20TT	IK20TT	IK20TT	4
1.6 LPG	75	CHGA		08/09-11/12	K20PBR-S10	5061	1.0	K20TT	IK20TT	IK20TT	4
1.6 MultiFuel	75	CCSA; CMXA		01/08-06/13	K20PBR-S10	5061	1.0	K20TT	IK20TT	IK20TT	4
1.6 TDI	77	CAYC		06/09-04/13	DG-193		4.4V				4
1.6 TDI 4x4	77	CAYC		06/09-02/13	DG-193		4.4V				4
1.8 TSI	112/ 118	BZB; CDAA; CDAB		06/07-06/13	PK22PR8	3273	0.8	-	-	VK22	4
1.8 TSI	112/ 118	BZB; CDAA; CDAB	OEM Optional	06/07-06/13	VK22	5610	0.8	-	-	VK22	4
1.8 TSI 4x4	112/ 118	CDAA; CDAB		11/08-02/13	PK22PR8	3273	0.8	-	-	VK22	4
1.8 TSI 4x4	112/ 118	CDAA; CDAB	OEM Optional	11/08-02/13	VK22	5610	0.8	-	-	VK22	4
1.9 TDI	77	BJB; BKC; BLS; BXE		06/04-12/10	DG-177		5V				4
1.9 TDI 4x4	77	BKC; BLS; BXE		11/04-12/10	DG-177		5V				4
2.0 FSI	110	BLY; BVZ		11/04-10/08	K20PR-U	3145	0.8	K20TT	IK20TT	IK20TT	4
2.0 FSI	110	BLR; BVY; BLR; BVY		11/04-10/08	VKA16	5622	1.1	-	-	VKA16	4
2.0 FSI 4x4	110	BLX; BVX		11/04-10/08	VKA16	5622	1.1	-	-	VKA16	4
2.0 RS	147	BWA; CCZA		10/05-02/13	PK22PR8	3273	0.8	-	-	VK22	4
2.0 RS	147	BWA; CCZA	OEM Optional	10/05-02/13	VK22	5610	0.8	-	-	VK22	4
2.0 TDI	103	BMM		11/05-05/10	DG-177		5V				4
2.0 TDI	100	AZV		02/04-05/10	DG-190		4.4V				4
2.0 TDI	81	CFHF; CLCA		03/10-06/13	DG-193		4.4V				4
2.0 TDI 16V	100/ 103	AZV; BKD		02/04-05/13	DG-190		4.4V				4
2.0 TDI 16V	103	CFHC; CLCB		02/04-05/13	DG-193		4.4V				4
2.0 TDI 16V 4x4	103	CFHC		05/10-02/13	DG-193		4.4V				4
2.0 TDI 4x4	103	BMM		07/06-05/10	DG-177		5V				4
2.0 TDI 4x4	81	CFHF		05/11-02/13	DG-193		4.4V				4
2.0 TDI RS	125	CEGA		04/06-02/13	DG-193		4.4V				4
OCTAVIA (5E) (12-)											
1.6 TDI	66/77	CLHA; CLHB		11/12-	DG-193		4.4V				4
1.6 TDI 4x4	77	CLHA		11/12-	DG-193		4.4V				4
2.0 TDI	110	CKFC; CRMB		11/12-	DG-193		4.4V				4
2.0 TDI 4x4	110	CKFC		11/12-	DG-193		4.4V				4
2.0 TDI RS	135	CUNA; CUPA		05/13-	DG-193		4.4V				4
RAPID (HN) (12-)											
1.2	55	CGPC		07/12-	KJ20DR-M11	3374	1.1	-	IK20TT	IK20TT	4
1.4 TSI	90	CAXA		07/12-	PKJ20CR8	3173	0.8	-	-	VK20G	4
1.6	77	CFNA		07/12-	KJ20DR-M11	3374	1.1	-	IK20TT	IK20TT	4
1.6 TDI	77	CAYC; CLNA		07/12-	DG-193		4.4V				4



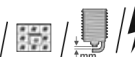



	KW								QTY		
SKODA continued											
RAPID (83-91)											
1.2 (120G)	43			02/83-12/90	W20FP-U	3068	0.7	WF20TT	-	-	4
1.3 (130G)	39/45	742.13; SKOD10		03/85-10/91	W20FPR-U	3070	0.7	WF20TT	-	-	4
1.3 S (135GL)	43	SKOD10		08/87-12/90	W20FPR-U	3070	0.7	WF20TT	-	-	4
ROOMSTER (5J) (06-)											
1.2	47/51	BME; BZG-E4		05/06-03/09	KJ16CR-L11	3132	1.1	K16TT	IK16TT	IK16TT	3
1.2	51	CGPA		03/09-	KJ20DR-M11	3374	1.1	-	IK20TT	IK20TT	3
1.2 TDI	55	CFWA		03/10-	DG-193		4.4V				3
1.4	63	BXW; CGGB		09/06-	KJ20DR-M11	3374	1.1	-	IK20TT	IK20TT	4
1.4 TDI	51/59	BMS; BNM; BNV		09/06-03/10	DG-109		11V				3
1.6	77	BTS; CFNA		09/06-	KJ20DR-M11	3374	1.1	-	IK20TT	IK20TT	4
1.6 TDI	66/77	CAYB; CAYC		03/10-	DG-193		4.4V				4
1.9 TDI	77	BSW		09/06-03/10	DG-109		11V				4
SUPERB (3T) (08-)											
1.4 TSI	92	CAXC		07/08-	PKJ20CR8	3173	0.8	-	-	VK20G	4
1.6 TDI	77	CAYC		09/10-	DG-193		4.4V				4
1.8 TSI	112/118	BZB; CDAA; CDAB		03/09-	PK22PR8	3273	0.8	-	-	VK22	4
1.8 TSI	112/118	BZB; CDAA; CDAB	OEM Optional	03/09-	VK22	5610	0.8	-	-	VK22	4
1.8 TSI 4x4	112/118	CDAA; CDAB		11/08-	PK22PR8	3273	0.8	-	-	VK22	4
1.8 TSI 4x4	112/118	CDAA; CDAB	OEM Optional	11/08-	VK22	5610	0.8	-	-	VK22	4
1.9 TDI	77	BLS; BXE		03/08-	DG-177		5V				4
2.0 TDI	125	CBBB; CFGB		07/08-	DG-193		4.4V				4
2.0 TDI 16V	103	BKD		01/09-	DG-190		4.4V				4
2.0 TDI 16V	103	CFFB; CLJA		01/09-	DG-193		4.4V				4
2.0 TDI 16V 4x4	103	CFFB		11/10-	DG-193		4.4V				4
2.0 TDI 4x4	125	CBBB; CFGB		09/08-	DG-193		4.4V				4
2.0 TSI	147	CCZA		05/10-	PK22PR8	3273	0.8	-	-	VK22	4
2.0 TSI	147	CCZA	OEM Optional	05/10-	VK22	5610	0.8	-	-	VK22	4
SUPERB (3U) (01-08)											
1.8 T	110	AWT		12/01-03/08	PK20PR-P8	3245	0.8	-	IK20TT	IK20TT	4
1.9 TDI	74/96	AVB; AVF; AWX		12/01-03/08	DG-109		11V				4
2.0	85	AZM		12/01-03/08	K20PBR-S10	5061	1.0	K20TT	IK20TT	IK20TT	4
2.5 TDI	114/120	AYM; BDG		12/01-03/08	DG-144		11V				6
2.8 V6	142	AMX; BBG		12/01-03/08	K20TXR	5063	1.0	K20TT	IK20TT	IK20TT	6
YETI (5L) (09-)											
1.4 TSI	90	CAXA		06/10-	PKJ20CR8	3173	0.8	-	-	VK20G	4
1.6 TDI	77	CAYC		11/10-	DG-193		4.4V				4
1.8 TSI 4x4	112/118	CDAA; CDAB		05/09-	PK22PR8	3273	0.8	-	-	VK22	4
1.8 TSI 4x4	112/118	CDAA; CDAB	OEM Optional	05/09-	VK22	5610	0.8	-	-	VK22	4
2.0 TDI	81/103	CFHA; CFHC; CLCA		11/09-	DG-193		4.4V				4
2.0 TDI 4x4	81/103/125	CBDB; CEGA; CFHC; CFHF; CFJA; CLCB		05/09-	DG-193		4.4V				4
SMART											
CABRIO (450) (00-04)											
0.6 (450.400, S1OLD2)	45	M 160.920; M 160 E6AL B05		01/01-01/04	K20TXR	5063	1.0	K20TT	IK20TT	IK20TT	6
0.6 (450.432)	52	M 160.920		06/02-01/04	K20TXR	5063	1.0	K20TT	IK20TT	IK20TT	6
0.6 (450.433, S1OLA1)	40	M 160.920; M 160 E6AL B03		03/00-01/04	K20TXR	5063	1.0	K20TT	IK20TT	IK20TT	6
0.8 CDI (450.401, 450.402, 450.403, S1OLC1)	30	OM 660.940; OM 660 DE 8LA		03/01-01/04	DG-184		11.5V				3
CITY-Coupe (450) (98-04)											
0.6 (450.330, 450.332)	52	M 160.920		06/02-01/04	K20TXR	5063	1.0	K20TT	IK20TT	IK20TT	6
0.6 (450.333, 450.335)	45	M 160.920; M 160 E6AL B05		01/01-01/04	K20TXR	5063	1.0	K20TT	IK20TT	IK20TT	6
0.6 (450.341, S1CLA1)	40	M 160.920; M 160 E6AL B03		07/98-01/04	K20TXR	5063	1.0	K20TT	IK20TT	IK20TT	6
0.6 (450.342, S1CLB1)	33	M 160.920; M 160 E6AL B04		07/98-01/04	K20TXR	5063	1.0	K20TT	IK20TT	IK20TT	6
0.8 CDI (450.300, 450.301, 450.302, 450.303, 450.306...)	30	OM 660.940; OM 660 DE 8LA		11/99-01/04	DG-184		11.5V				3
CROSSBLADE (450) (02-03)											
0.6 (450.418)	52	M 160.920		06/02-12/03	K20TXR	5063	1.0	K20TT	IK20TT	IK20TT	6











KW	KW	KW	NOTE	21	Standard			Twin Tip			QTY
					Standard	Standard	Standard	Twin Tip	Twin Tip	Twin Tip	
SMART <i>continued</i>											
FORFOUR (454) (04-06)											
1.1 (454.030)	55	M 134.910		01/04-06/06	K20HR-U11	3381	1.1	KH20TT	IKH20TT	IKH20TT	3
1.1 (454.033)	47	M 134.911		02/05-06/06	K20HR-U11	3381	1.1	KH20TT	IKH20TT	IKH20TT	3
1.3 (454.031)	70	M 135.930		01/04-06/06	K20HR-U11	3381	1.1	KH20TT	IKH20TT	IKH20TT	4
1.5 (454.032)	90	M 135.950		01/04-06/06	IKH20	5344	1.1	-	IKH20TT	IKH20TT	4
1.5 (454.032)	80	M 135.950		01/04-06/06	K20HR-U11	3381	1.1	KH20TT	IKH20TT	IKH20TT	4
1.5 CDI (454.000)	50	OM 639.939		09/04-06/06	DG-606		11.5V				3
1.5 CDI (454.001)	70	OM 639.939		09/04-06/06	DG-606		11.5V				3
FORTWO (450) (04-07)											
0.8 CDI (450.300, 450.301, 450.302, 450.303, 450.306)	30	OM 660.940; OM 660 DE 8LA		01/04-01/07	DG-184		11.5V				3
0.8 CDI (450.401, 450.402, 450.403)	30	OM 660.940; OM 660 DE 8LA		01/04-01/07	DG-184		11.5V				3
FORTWO (451) (07-)											
0.8 CDI (451.300)	33	OM 660.950		01/07-07/09	DG-184		11.5V				3
0.8 CDI (451.400)	33	OM 660.950		01/07-	DG-184		11.5V				3
1.0	88			01/10-	XU22HDR9	3445	0.9	XUH22TT	-	VXUH22	3
1.0 (451.330, 451.334)	45	M 132.910		01/07-	XU22HDR9	3445	0.9	XUH22TT	-	VXUH22	3
1.0 (451.331, 451.380)	52	M 132.910		01/07-	XU22HDR9	3445	0.9	XUH22TT	-	VXUH22	3
1.0 (451.431, 451.480)	52	M 132.910		01/07-	XU22HDR9	3445	0.9	XUH22TT	-	VXUH22	3
1.0 Brabus	88			04/12-	XU22HDR9	3445	0.9	XUH22TT	-	VXUH22	3
1.0 Brabus (451.333)	72	M 132.930		01/08-	XU22HDR9	3445	0.9	XUH22TT	-	VXUH22	3
1.0 Brabus (451.433)	72	M 132.930		01/08-	XU22HDR9	3445	0.9	XUH22TT	-	VXUH22	3
1.0 Turbo (451.332)	62	M 132.930		01/07-	XU22HDR9	3445	0.9	XUH22TT	-	VXUH22	3
1.0 Turbo (451.432)	62	M 132.930		01/07-	XU22HDR9	3445	0.9	XUH22TT	-	VXUH22	3
1.0 Turbo Brabus (451.333)	75	M 132.930		07/10-	XU22HDR9	3445	0.9	XUH22TT	-	VXUH22	3
1.0 Turbo Brabus (451.433)	75	M 132.930		07/10-	XU22HDR9	3445	0.9	XUH22TT	-	VXUH22	3
SPYKER											
C8 (00-)											
4.2	298	BFM		04/00-	IK22	5310	0.8	-	-	VK22	8
C8 Aileron (10-)											
4.2	298	BFM		04/10-	IK22	5310	0.8	-	-	VK22	8
C12 (07-)											
Zagato	368	BHT		12/07-	PKJ20CR-L11	3247	1.1	-	IK20TT	IK20TT	12
SSANGYONG											
ACTYON I (05-)											
2.3	110	G23D		11/06-01/11	Q16PR-U11	5016	1.1	Q16TT	IQ16TT	IQ16TT	4
2.3 4x4	110	G23D		11/06-01/11	Q16PR-U11	5016	1.1	Q16TT	IQ16TT	IQ16TT	4
CHAIRMAN (97-)											
2.3	110	M 111.970; M 111.974		07/97-01/11	Q16PR-U11	5016	1.1	Q16TT	IQ16TT	IQ16TT	4
ISTANA (92-)											
2.3	110			06/95-01/11	Q16PR-U11	5016	1.1	Q16TT	IQ16TT	IQ16TT	4
KORANDO (88-96)											
2.2 D	50	DC23		12/88-12/96	DG-124		11V				4
KORANDO (96-)											
2.0	94	M111E20		05/97-03/99	Q16PR-U11	5016	1.1	Q16TT	IQ16TT	IQ16TT	4
2.3	103/105/110	M 111.970; M 161.970; M111E23		05/97-01/11	Q16PR-U11	5016	1.1	Q16TT	IQ16TT	IQ16TT	4
2.3 D (KJ)	58	OM 601.940		12/96-	DG-010		11.5V				4
2.9 D	72	MB-OM 662		11/97-	DG-010		11.5V				5
2.9 D (KJ)	72	MB-OM 662		12/96-	DG-010		11.5V				5
2.9 TD	88			04/98-	DG-010		11.5V				5
3.2	156	M 104.995		01/99-09/05	Q16PR-U11	5016	1.1	Q16TT	IQ16TT	IQ16TT	6
3.2	162	M 104.992		06/97-	Q20PR-U	3007	0.8	Q20TT	IQ20TT	IQ20TT	6
3.2 (KJ)	154	M 104.995		12/96-09/05	Q16PR-U11	5016	1.1	Q16TT	IQ16TT	IQ16TT	6
3.2 4x4	154	M104.995		06/97-11/02	Q16PR-U11	5016	1.1	Q16TT	IQ16TT	IQ16TT	6
KYRON (05-)											
2.0 Xdi	104	D20DT		05/05-	DG-188		11V				4
2.0 Xdi 4x4	104	D20DT		05/05-	DG-188		11V				4
2.3	110	M 161.970		01/10-01/11	Q16PR-U11	5016	1.1	Q16TT	IQ16TT	IQ16TT	4
2.7 Xdi	121	D27DT		05/05-	DG-188		11V				5
3.2 M320 4WD	162	M104.995		03/08-	Q16PR-U11	5016	1.1	Q16TT	IQ16TT	IQ16TT	6
MUSSO (93-)											
2.0	93	M111E20		10/96-04/05	Q16PR-U11	5016	1.1	Q16TT	IQ16TT	IQ16TT	4
2.3	110	M161 E23		04/03-04/05	Q16PR-U11	5016	1.1	Q16TT	IQ16TT	IQ16TT	4
2.3	103	M 111.970		10/96-	Q20PR-U	3007	0.8	Q20TT	IQ20TT	IQ20TT	4







	KW								QTY
SSANGYONG <i>continued</i>									
MUSSO (93-) <i>continued</i>									
2.3 D	59	MB-OM 661; OM 601.940		10/95-	DG-010		11.5V		4
2.9 D	73	MB-OM 662		03/96-	DG-010		11.5V		5
2.9 TD	88			04/98-	DG-010		11.5V		5
3.2	162	M 104.992		06/96-	Q20PR-U	3007	0.8	Q20TT IQ20TT	6
REXTON (02-)									
2.3 RX230 4x4	110	G23D		05/02-01/11	Q16PR-U11	5016	1.1	Q16TT IQ16TT	4
2.7 Xdi	120	D27DT		08/04-	DG-188		11V		5
2.9 TD	88			04/02-	DG-010		11.5V		5
3.2	162	M104.995		04/02-	Q16PR-U11	5016	1.1	Q16TT IQ16TT	6
RODIUS I (05-)									
2.7 Xdi	120	D27DT		05/05-	DG-188		11V		5
2.7 Xdi 4WD	120	D27DT		05/05-	DG-188		11V		5
3.2	162	M104.995		05/05-	Q16PR-U11	5016	1.1	Q16TT IQ16TT	6
3.2 4WD	162	M104.995		07/07-	Q16PR-U11	5016	1.1	Q16TT IQ16TT	6
STAVIC (05-)									
3.2 4x4	162	M104.995		02/05-	Q16PR-U11	5016	1.1	Q16TT IQ16TT	6
SUBARU									
1800 XT COUPE (84-90)									
1.8 Turbo	100	EA82		11/85-07/90	W22EPR-U	3088	0.8	W22TT - VW22	4
1.8 Turbo 4WD	88/96/100	EA82		11/84-12/90	W22EPR-U	3088	0.8	W22TT - VW22	4
BRZ (12-)									
2.0	147	FA20		06/12-	VXEBH27	5686	0.8	- - VXEBH27	4
FORESTER (97-02)									
2.0	90	EJ20J		08/97-06/98	K16PR-U11	3130	1.1	K16TT IK16TT	4
2.0	92	EJ202		06/98-09/02	K20PR-U11	3121	1.1	K20TT IK20TT	4
2.0 S Turbo	125/130	EJ205	OEM Optional	06/98-09/02	PK20PR-P8	3245	0.8	- IK20TT	4
2.5 AWD	123	EJ25D		07/97-05/02	PK16PR-L11	3275	1.1	- IK16TT	4
FORESTER (02-)									
2.0	92	EJ20		09/02-	PK16PR11	3264	1.1	K16TT IK16TT	4
2.0 S Turbo	130	EJ20		09/02-12/07	PK20PR-P8	3245	0.8	- IK20TT	4
2.0 S Turbo	130	EJ20		01/08-	VKH20Y	5639	0.8	- - VKH20Y	4
2.0 X	116	EJ204		09/05-	VKH20	5618	1.1	- IKH20TT	4
2.0 X	116	EJ204	LPG / GPL	09/05-	VKH22	5619	0.8	- - VKH22	4
2.5	155	EJ25		12/03-	VKH20	5618	1.1	- IKH20TT	4
2.5 All-wheel Drive	121	EJ25D		07/05-	PK16PR-L11	3275	1.1	- IK16TT	4
2.5 RX Nato AWD	115	EJ25		11/02-08/05	VKH20	5618	1.1	- IKH20TT	4
2.5 XT	169	EJ255		09/05-	VKH20	5618	1.1	- IKH20TT	4
FORESTER (08-)									
2.0 AWD	110	FB20		12/11-	VFXEH22	5646	1.1	- IXEH22TT	4
2.0 AWD	110	EJ20		01/08-	VKH20	5618	1.1	- IKH20TT	4
2.5 AWD	126/169	EJ25; EJ255		06/08-	VKH20	5618	1.1	- IKH20TT	4
FORESTER (13-)									
2.0 X	110	FB20		03/13-	VFXEH22	5646	1.1	- IXEH22TT	4
IMPREZA (92-00)									
1.5	70			11/94-08/98	K20PR-U11	3121	1.1	K20TT IK20TT	4
1.5 L	66/70			11/95-09/00	K20PR-U11	3121	1.1	K20TT IK20TT	4
1.6	70	EJ161		09/98-09/00	K20PR-U11	3121	1.1	K20TT IK20TT	4
1.6 AWD	66	EJ161		12/96-12/00	K20PR-U11	3121	1.1	K20TT IK20TT	4
1.6 i	66/70	EJ16; EJ161		08/92-12/00	K20PR-U11	3121	1.1	K20TT IK20TT	4
1.6 i AWD	66/70	EJ16; EJ161		08/92-12/00	K20PR-U11	3121	1.1	K20TT IK20TT	4
1.8	76	EJ18		01/93-10/95	K20PR-U11	3121	1.1	K20TT IK20TT	4
1.8 i	76	EJ18E; EJ18ENX		11/95-06/96	K20PR-U11	3121	1.1	K20TT IK20TT	4
1.8 i AWD	76	EJ18		08/92-12/00	K20PR-U11	3121	1.1	K20TT IK20TT	4
2.0	85	EJ20E		09/96-08/98	K20PR-U11	3121	1.1	K20TT IK20TT	4
2.0	92	EJ201		09/98-09/00	PK20PR-P8	3245	0.8	- IK20TT	4
2.0 AWD	85	EJ20		12/95-09/98	K20PR-U11	3121	1.1	K20TT IK20TT	4
2.0 AWD	85/206	EJ205P		09/98-12/00	PK20PR-P8	3245	0.8	- IK20TT	4
2.0 i	85	EJ20E		11/95-09/98	K20PR-U11	3121	1.1	K20TT IK20TT	4
2.0 i	85/92	EJ20E; EJ201		09/98-09/00	PK20PR-P8	3245	0.8	- IK20TT	4
2.0 i 16V AWD	92	EJ20		06/98-12/00	PK20PR-P8	3245	0.8	- IK20TT	4
2.0 i AWD	85	EJ20		10/95-09/98	K20PR-U11	3121	1.1	K20TT IK20TT	4
2.0 i AWD	85/92	EJ20		06/98-12/00	PK20PR-P8	3245	0.8	- IK20TT	4
2.0 i Turbo AWD	155	EJ20 (Turbo)		03/94-12/00	PK20PR-P8	3245	0.8	- IK20TT	4







Spark & Glow Plugs

Application Tables

	KW				Standard 				Twin Tip 			QTY
SUBARU <i>continued</i>												
IMPREZA (92-00) <i>continued</i>												
2.0 Turbo AWD	155	EJ20G		12/96-12/00	PK20PR-P8	3245	0.8	-	IK20TT	IK20TT		4
2.0 Turbo GT AWD	155/160	EJ20 (Turbo); EJ205		03/94-12/00	PK20PR-P8	3245	0.8	-	IK20TT	IK20TT		4
IMPREZA (00-)												
1.5	81	EL15		10/05-	IKH20	5344	1.1	-	IKH20TT	IKH20TT		4
1.5	74	EJ15		06/01-09/05	PK16PR11	3264	1.1	K16TT	IK16TT	IK16TT		4
1.5 AWD	77/81	EL15		10/05-	IKH20	5344	1.1	-	IKH20TT	IKH20TT		4
1.6 AWD	70	EJ16(161)		12/00-08/05	K20PR-U11	3121	1.1	K20TT	IK20TT	IK20TT		4
2.0 AWD	92	EJ20		12/00-	KJ20SR11	3378	1.1	-	IK20TT	IK20TT		4
2.0 AWD	184/206	EJ205P		10/05-	PK20PR-P8	3245	0.8	-	IK20TT	IK20TT		4
2.0 i All-wheel Drive	92/118	EJ201; EJ204		12/02-12/07	KJ20SR11	3378	1.1	-	IK20TT	IK20TT		4
2.0 i All-wheel Drive	150	EJ205		12/01-11/02	PK20PR-P8	3245	0.8	-	IK20TT	IK20TT		4
2.0 i AWD	92	EJ20		12/00-	KJ20SR11	3378	1.1	-	IK20TT	IK20TT		4
2.0 i R AWD	118	EJ20; EJ204		09/05-	KJ20SR11	3378	1.1	-	IK20TT	IK20TT		4
2.0 i WRX All-wheel Drive	168	EJ205		12/02-09/05	PK22PR8	3273	0.8	-	-	VK22		4
2.0 i WRX AWD	168	EJ205		12/02-09/05	PK22PR8	3273	0.8	-	-	VK22		4
2.0 Turbo AWD	160	EJ205		12/00-	PK20PR-P8	3245	0.8	-	IK20TT	IK20TT		4
2.0 WRX STi All-wheel Drive	195	EJ207		12/02-09/05	PK22PR8	3273	0.8	-	-	VK22		4
2.0 WRX STi All-wheel Drive	195	EJ207	OEM Optional	12/02-09/05	VK22	5610	0.8	-	-	VK22		4
2.0 WRX STi AWD	195/206/235	EJ207; EJ208		11/01-	PK22PR8	3273	0.8	-	-	VK22		4
2.0 WRX STi AWD	195/206/235	EJ207; EJ208	OEM Optional	11/01-	VK22	5610	0.8	-	-	VK22		4
2.0 WRX Turbo AWD	160/165	EJ205		06/06-	PK20PR-P8	3245	0.8	-	IK20TT	IK20TT		4
2.0 WRX Turbo AWD	160/165	EJ205		12/00-06/06	PK22PR8	3273	0.8	-	-	VK22		4
2.5 AWD	199/221	EJ255; EJ257		10/05-	VKH22	5619	0.8	-	-	VKH22		4
2.5 i WRX AWD	169	EJ255		09/05-	VKH22	5619	0.8	-	-	VKH22		4
2.5 WRX	169	EJ255		09/05-	VKH22	5619	0.8	-	-	VKH22		4
2.5 WRX AWD	169	EJ255		09/05-	VKH22	5619	0.8	-	-	VKH22		4
2.5 WRX STi AWD	206	EJ257		09/05-	VKH22	5619	0.8	-	-	VKH22		4
IMPREZA (08-)												
1.5	79	EL15		02/08-	FK20HR11	3426	1.1	-	IKH20TT	IKH20TT		4
1.5 AWD	79	EL15		02/08-	FK20HR11	3426	1.1	-	IKH20TT	IKH20TT		4
1.5 F	79	EL15		02/08-	FK20HR11	3426	1.1	-	IKH20TT	IKH20TT		4
2.0	110	EJ204		02/08-	VKH20	5618	1.1	-	IKH20TT	IKH20TT		4
2.0	110	EJ204	LPG / GPL	02/08-	VKH22	5619	0.8	-	-	VKH22		4
2.0 i AWD	110	EJ204		01/11-	VKH20	5618	1.1	-	IKH20TT	IKH20TT		4
2.0 i AWD	110	EJ204	LPG / GPL	01/11-	VKH22	5619	0.8	-	-	VKH22		4
2.0 R AWD	110	EJ204		01/08-	VKH20	5618	1.1	-	IKH20TT	IKH20TT		4
2.0 R AWD	110	EJ204	LPG / GPL	01/08-	VKH22	5619	0.8	-	-	VKH22		4
2.5	221	EJ257		02/08-	VKH20Y	5639	0.8	-	-	VKH20Y		4
2.5 AWD	169/199	EJ255; EJ257		07/07-	VKH20Y	5639	0.8	-	-	VKH20Y		4
2.5 STi CS400 AWD	294	EJ257		04/10-	VKH20Y	5639	0.8	-	-	VKH20Y		4
2.5 WRX S AWD	188	EJ255		02/09-12/10	VKH20Y	5639	0.8	-	-	VKH20Y		4
2.5 WRX SE AWD	195	EJ255		06/12-	VKH20Y	5639	0.8	-	-	VKH20Y		4
2.5 WRX STi 330S AWD	243	EJ257		05/09-12/10	VKH20Y	5639	0.8	-	-	VKH20Y		4
2.5 WRX STi AWD	221	EJ257		01/08-	VKH20Y	5639	0.8	-	-	VKH20Y		4
IMPREZA (11-)												
1.6 i	84	FB16		06/12-	VFXEH22	5646	1.1	-	IXEH22TT	IXEH22TT		4
1.6 i AWD	84	FB16		06/12-	VFXEH22	5646	1.1	-	IXEH22TT	IXEH22TT		4
2.5 WRX STi AWD	221/236	EJ257		10/11-	VKH20Y	5639	0.8	-	-	VKH20Y		4
JUSTY I (84-95)												
1000	37/40	EF10		11/84-10/95	W20EPR-U11	3049	1.1	W20TT	IW20TT	IW20TT		3
1000 4WD (KAD-A)	37/40	EF10		11/84-11/94	W20EPR-U11	3049	1.1	W20TT	IW20TT	IW20TT		3
1200	49	EF12		05/87-10/95	W20EPR-U11	3049	1.1	W20TT	IW20TT	IW20TT		3
1200 4WD	50/55	EF12		10/86-12/94	W20EPR-U11	3049	1.1	W20TT	IW20TT	IW20TT		3
1200 4WD (KAD-A)	49	EF12		05/87-05/91	W20EPR-U11	3049	1.1	W20TT	IW20TT	IW20TT		3
JUSTY II (95-03)												
1.3 4x4	63	G13BB		04/01-11/03	VK20	5604	1.1	-	IK20TT	IK20TT		4
1.3 GX 4x4	50	EF13		10/95-11/03	W20EPR-U11	3049	1.1	W20TT	IW20TT	IW20TT		4







	KW										QTY
SUBARU <i>continued</i>											
JUSTY III (03-)											
1.3	69	M13A		09/03-	VK20	5604	1.1	-	IK20TT	IK20TT	4
1.5	73	M15A		09/03-	VK20	5604	1.1	-	IK20TT	IK20TT	4
JUSTY IV (07-)											
1.0	51	1KR-FE		01/07-	SK20HR11	3421	1.1	-	IKH20TT	IKH20TT	3
LEGACY I (89-94)											
1.6	70	EJ16		05/89-12/93	K20PR-U11	3121	1.1	K20TT	IK20TT	IK20TT	4
1.6 GL	70	EJ16		05/89-12/93	K20PR-U11	3121	1.1	K20TT	IK20TT	IK20TT	4
2.0	85	EJ20EN		08/91-12/93	K20PR-U11	3121	1.1	K20TT	IK20TT	IK20TT	4
1800	76	EJ18 SPI		01/89-07/94	K20PR-U11	3121	1.1	K20TT	IK20TT	IK20TT	4
1800 4WD	76	EJ18 SPI		01/89-07/94	K20PR-U11	3121	1.1	K20TT	IK20TT	IK20TT	4
2000	85	EJ20EN		09/91-12/93	K20PR-U11	3121	1.1	K20TT	IK20TT	IK20TT	4
2000 4WD	85	EJ20 EMPI		09/91-07/94	K20PR-U11	3121	1.1	K20TT	IK20TT	IK20TT	4
2000 Turbo 4WD	147	EJ20-GN		05/92-07/94	PK20PR-P8	3245	0.8	-	IK20TT	IK20TT	4
2000 Turbo Super 4WD	147	EJ20-GN		05/92-07/94	PK20PR-P8	3245	0.8	-	IK20TT	IK20TT	4
2200 4WD	100	EJ22 EMPI		01/89-07/94	K20PR-U11	3121	1.1	K20TT	IK20TT	IK20TT	4
2200 Super 4WD	100	EJ22 EMPI		01/89-07/94	K20PR-U11	3121	1.1	K20TT	IK20TT	IK20TT	4
LEGACY II (94-99)											
2.0 i	85	EJ20 EMPI; EJ20E		09/94-03/99	K20PR-U11	3121	1.1	K20TT	IK20TT	IK20TT	4
2.0 i 4WD	85	EJ20		09/94-11/98	PK22PR8	3273	0.8	-	-	VK22	4
2.0 i 4WD	85	EJ20	For vehicles with switchable power steering (city mode)	09/94-03/99	K20PR-U11	3121	1.1	K20TT	IK20TT	IK20TT	4
2.2	94	EJ22ER		07/94-06/97	K20PR-U11	3121	1.1	K20TT	IK20TT	IK20TT	4
2.2 i 4WD	94/96	EJ22 EMPI; EJ22ER		02/94-12/98	K20PR-U11	3121	1.1	K20TT	IK20TT	IK20TT	4
2.5 i 4WD	110	EJ25D		06/96-03/99	PK20PR11	3168	1.1	K20TT	IK20TT	IK20TT	4
LEGACY III (98-03)											
2.0	92	EJ201		04/99-08/03	K16PR-U11	3130	1.1	K16TT	IK16TT	IK16TT	4
2.0 AWD	92	EJ201		12/98-08/03	K16PR-U11	3130	1.1	K16TT	IK16TT	IK16TT	4
2.5	115	EJ251		10/98-08/03	K16PR-U11	3130	1.1	K16TT	IK16TT	IK16TT	4
2.5 AWD	115	EJ251		12/98-08/03	K16PR-U11	3130	1.1	K16TT	IK16TT	IK16TT	4
LEGACY IV (03-)											
2.0	101/ 121/ 132/ 140	EJ20		09/03-	VK20	5604	1.1	-	IK20TT	IK20TT	4
2.0 R	110	EJ204(150)		09/07-	VKH20	5618	1.1	-	IKH20TT	IKH20TT	4
2.0 R	110	EJ204	LPG / GPL	09/07-	VKH22	5619	0.8	-	-	VKH22	4
2.5	121	EJ25		09/03-	PK16PR-L11	3275	1.1	-	IK16TT	IK16TT	4
3.0 R	180	EZ30-245 - D4		09/03-	VKH20	5618	1.1	-	IKH20TT	IKH20TT	6
LEGACY OUTBACK (96-99)											
2.5	110	EJ25D		01/96-06/97	PK20PR11	3168	1.1	K20TT	IK20TT	IK20TT	4
LEGACY V (09-)											
2.0 i	110	204		09/09-	VKH20	5618	1.1	-	IKH20TT	IKH20TT	4
2.0 i	110	EJ204; FB20	LPG / GPL	09/09-	VKH22	5619	0.8	-	-	VKH22	4
2.0 i AWD	110	204		09/09-	VKH20	5618	1.1	-	IKH20TT	IKH20TT	4
2.0 i AWD	110	EJ204	LPG / GPL	09/09-	VKH22	5619	0.8	-	-	VKH22	4
2.5 GT	195	253		07/10-	VKH20Y	5639	0.8	-	-	VKH20Y	4
2.5 GT AWD	195	253		07/10-	VKH20Y	5639	0.8	-	-	VKH20Y	4
2.5 i	123	253		09/09-	VK20	5604	1.1	-	IK20TT	IK20TT	4
2.5 i AWD	123	253		09/09-	VK20	5604	1.1	-	IK20TT	IK20TT	4
LEONE I (78-84)											
1600	63	EA71		03/79-10/84	W20EP-U	3043	0.8	W20TT	IW20TT	IW20TT	4
1600 4WD	52	EA71		03/79-10/84	W20EP-U	3043	0.8	W20TT	IW20TT	IW20TT	4
1800 4WD	59/60	EA81		09/80-10/84	W20EP-U	3043	0.8	W20TT	IW20TT	IW20TT	4
1800 4WD (AM)	59	EA81		09/80-10/84	W20EP-U	3043	0.8	W20TT	IW20TT	IW20TT	4
1800 Super 4WD (AM, AJ)	60	EA81		09/80-10/84	W20EP-U	3043	0.8	W20TT	IW20TT	IW20TT	4
1800 Turismo 4WD	60	EA81		09/80-10/84	W20EP-U	3043	0.8	W20TT	IW20TT	IW20TT	4
LEONE II (84-94)											
1.8	66	EA82		06/85-07/87	W20EPR-U	3047	0.8	W20TT	IW20TT	IW20TT	4
1.8	77	EA82-105		06/85-07/86	W20EPR-U11	3049	1.1	W20TT	IW20TT	IW20TT	4
1.8 GL	59	EA81		08/86-07/89	W20EPR-U	3047	0.8	W20TT	IW20TT	IW20TT	4
1.8 Turbo AWD	100	EA82		06/85-07/86	W22EPR-U	3088	0.8	W22TT	-	VW22	4
1300	48	EA65-65		11/84-09/91	W20EPR-U11	3049	1.1	W20TT	IW20TT	IW20TT	4
1600	55	EA71-74		11/84-09/91	W20EPR-U11	3049	1.1	W20TT	IW20TT	IW20TT	4
1800 4WD	66/ 72/ 88	EA82		11/84-12/90	W20EPR-U	3047	0.8	W20TT	IW20TT	IW20TT	4
1800 4WD CAT	70	EA82-98		07/86-09/91	W20EPR-U11	3049	1.1	W20TT	IW20TT	IW20TT	4
1800 Super 4WD	96	EA82		03/89-12/90	W20EPR-U	3047	0.8	W20TT	IW20TT	IW20TT	4

	KW					Standard			Twin Tip				QTY	
SUBARU <i>continued</i>														
LEONE II (84-94) <i>continued</i>														
1800 Super 4WD CAT	70	EA82		07/86-02/92	W20EXR-U11	3067	1.1	W20TT	IW20TT	IW20TT			4	
1800 Super Turbo 4WD	100	EA82		11/84-12/90	W22EPR-U	3088	0.8	W22TT	-	VW22			4	
1800 Turbo 4WD	96/ 100	EA82		11/84-12/90	W22EPR-U	3088	0.8	W22TT	-	VW22			4	
LIBERO (83-00)														
1.0 4WD (E10, KJ6)	37	EF10; EF10JF1;EF10JL1; EF10JS1, EF10JT1		01/83-12/87	W20EPR-U11	3049	1.1	W20TT	IW20TT	IW20TT			3	
1.2 4WD (E12, KJ8)	38	EF12;EF12EF; EF12EN, EF12ER, EF12EX		08/86-01/98	W20EPR-U11	3049	1.1	W20TT	IW20TT	IW20TT			3	
1.2 i 4WD (E12, FA)	40	EF12ER		04/94-11/98	W20EPR-U11	3049	1.1	W20TT	IW20TT	IW20TT			3	
MV (78-86)														
1.6	52	EA71		06/78-04/81	W20EPR-U	3047	0.8	W20TT	IW20TT	IW20TT			4	
1.8	60/66	EA81		05/81-08/86	W20EPR-U	3047	0.8	W20TT	IW20TT	IW20TT			4	
1.8 All-wheel Drive	73			05/81-08/86	W20EPR-U	3047	0.8	W20TT	IW20TT	IW20TT			4	
OUTBACK (00-03)														
2.5	115	EJ251		10/00-08/03	K16PR-U11	3130	1.1	K16TT	IK16TT	IK16TT			4	
3.0 H6	154	EZ30		10/00-08/03	VKH20	5618	1.1	-	IKH20TT	IKH20TT			6	
OUTBACK (03-09)														
2.0	101	EJ20		09/03-10/05	VK20	5604	1.1	-	IK20TT	IK20TT			4	
2.5	121	EJ25D		11/03-09/09	PK16PR-L11	3275	1.1	-	IK16TT	IK16TT			4	
2.5	127	EJ251		09/08-09/09	VK20	5604	1.1	-	IK20TT	IK20TT			4	
3.0 AWD	180	EZ30-245 - D4		11/03-09/09	VKH20	5618	1.1	-	IKH20TT	IKH20TT			6	
OUTBACK (09-)														
2.5 i	123	253		09/09-	VK20	5604	1.1	-	IK20TT	IK20TT			4	
3.6 R	191	36D		09/09-	VKH20	5618	1.1	-	IKH20TT	IKH20TT			6	
REX II (81-89)														
700	27	EK42		08/82-06/89	W20EPR-U11	3049	1.1	W20TT	IW20TT	IW20TT			2	
REX III (89-92)														
0.7	35/47	EN07E		07/90-03/92	K20PR-U11	3121	1.1	K20TT	IK20TT	IK20TT			4	
0.7 4WD	35	EN07E		07/90-03/92	K20PR-U11	3121	1.1	K20TT	IK20TT	IK20TT			4	
0.7 Kompressor 4WD	47	EN07E		07/90-02/92	K20PR-U11	3121	1.1	K20TT	IK20TT	IK20TT			4	
SVX (92-97)														
3.3 i 24V 4WD (CXW)	162/ 169	EG33-220; EG33-230		09/92-12/97	PK20PR11	3168	1.1	K20TT	IK20TT	IK20TT			6	
TREZIA (11-)														
1.3	73	1NR-FE; 1NR-FKE		03/11-	SC20HR11	3444	1.1	-	IXEH22TT	IXEH22TT			4	
1.4 D	66	1ND-TV		03/11-	DG-240		11V						4	
TRIBECA (05-)														
3.0	180/ 184	EZ30		01/05-09/07	VKH20Y	5639	0.8	-	-	VKH20Y			6	
3.6	190	36D(258)		09/07-	VKH20	5618	1.1	-	IKH20TT	IKH20TT			6	
VIVIO (92-98)														
0.7	32	EN07A2M;EN07AEC; EN07AFM		08/92-10/95	K16PR-U11	3130	1.1	K16TT	IK16TT	IK16TT			4	
0.7	32	EN07ERC;EN07ERM		08/92-10/95	K20PR-U11	3121	1.1	K20TT	IK20TT	IK20TT			4	
660 4WD	32	EN07ERW		03/92-10/95	K20PR-U11	3121	1.1	K20TT	IK20TT	IK20TT			4	
XV (12-)														
2.0 i	110	FB20B		03/12-	VFXEH22	5646	1.1	-	IXEH22TT	IXEH22TT			4	
SUZUKI														
ALTO I (82-85)														
0.8 (SS80F, SS80G)	29	F8A		06/82-08/84	W16EXR-U	3031	0.8	W16TT	IW16TT	IW16TT			3	
ALTO II (86-93)														
0.8 (SB308/CA)	29	F8B		01/86-12/88	W16EPR-U	3021	0.8	W16TT	IW16TT	IW16TT			3	
ALTO III (93-02)														
1.0	43	G10B-58		01/00-06/02	K20PR-U	3145	0.8	K20TT	IK20TT	IK20TT			4	
1.0	39	G10B		09/94-09/98	W16EXR-U	3031	0.8	W16TT	IW16TT	IW16TT			4	
ALTO IV (02-08)														
1.1	46	F10D; F10DN		09/04-12/08	XU22EPR-U	3179	0.9	XU22TT	-	VXU22			4	
ALTO V (09-)														
1.0	50	K10B		01/09-	ZXU20PR11	3452	1.1	-	-	VXU22			3	
BALENO (95-02)														
1.3	52	G13BB - E6		09/96-05/02	K20PR-U	3145	0.8	K20TT	IK20TT	IK20TT			4	
1.3 16V	63	G13BB		03/97-05/02	K20PR-U	3145	0.8	K20TT	IK20TT	IK20TT			4	
1.3 i 16V	63	G13BB		07/95-05/02	K20PR-U	3145	0.8	K20TT	IK20TT	IK20TT			4	
1.6 i 16V	72	G16B		07/95-05/02	K20PR-U	3145	0.8	K20TT	IK20TT	IK20TT			4	
1.6 i 16V	73	G16BA		08/96-05/02	K20PR-U11	3121	1.1	K20TT	IK20TT	IK20TT			4	
1.6 i 16V 4x4	72	G16B		07/95-05/02	K20PR-U	3145	0.8	K20TT	IK20TT	IK20TT			4	

	KW					Standard		Twin Tip		QTY	
SUZUKI <i>continued</i>											
BALENO (95-02) <i>continued</i>											
1.6 i 16V 4x4	73	G16BA		08/96-05/02	K20PR-U11	3121	1.1	K20TT	IK20TT	IK20TT	4
1.8 GTX	89	J18A		03/96-05/02	K20PR-U11	3121	1.1	K20TT	IK20TT	IK20TT	4
1.8 i 16V	89	J18A		08/96-05/02	K20PR-U11	3121	1.1	K20TT	IK20TT	IK20TT	4
1.9 TD	55	DHV (XUD9BSD); DHW (XUD9SD)		04/98-05/02	DG-001		11V				4
CAPPUCINO (92-95)											
0.7 (EA11)	47	F6A-T(64)		02/92-08/95	IXU22	5308	0.9	-	-	VXU22	3
CARRY (80-85)											
0.8	27	F8A		11/80-10/85	W16EPR-U	3021	0.8	W16TT	IW16TT	IW16TT	4
CARRY (99-)											
1.3	58	G13BB		03/99-	W20EPR-U	3047	0.8	W20TT	IW20TT	IW20TT	4
1.3 16 V	58	G13BB/E6		03/00-01/04	K20PR-U	3145	0.8	K20TT	IK20TT	IK20TT	4
1.3 4x4	56	G13BB/E6		02/99-09/04	K20PR-U	3145	0.8	K20TT	IK20TT	IK20TT	4
GRAND VITARA (98-06)											
1.6	69	G16B		03/98-07/03	PK20PR-L11	3142	1.1	-	IK20TT	IK20TT	4
2.0 4x4	94	J20A(128)		03/98-07/03	K20PR-U11	3121	1.1	K20TT	IK20TT	IK20TT	4
2.0 4x4	94	J20A(128)	OEM Optional	03/98-07/03	VK20	5604	1.1	-	IK20TT	IK20TT	4
2.0 HDI 110	80	RHZ		07/01-09/05	DG-116		11V				4
2.0 HDI 110 16V	80	RHW		07/01-09/05	DG-116		11V				4
2.0 TD	64	RF		03/98-07/03	DG-146		11V				4
2.0 TD 4x4	63	RFM		04/00-09/05	DG-146		11V				4
2.5 V6 24V (FT)	106	H25A		04/98-07/03	K20PR-U11	3121	1.1	K20TT	IK20TT	IK20TT	6
2.5 V6 24V 4x4	116	H 25 A		04/01-07/03	K20PR-U11	3121	1.1	K20TT	IK20TT	IK20TT	6
2.7	135	H 27 A		09/03-08/06	VK20	5604	1.1	-	IK20TT	IK20TT	6
2.7 4x4	127/ 135	H27A; H27A-184		09/01-07/03	K20PR-U11	3121	1.1	K20TT	IK20TT	IK20TT	6
GRAND VITARA (05-)											
1.3	59/61	G13BB; M13A		05/05-	VK20	5604	1.1	-	IK20TT	IK20TT	4
1.6 All-wheel Drive	73/78	M16A		04/05-	K20PR-U11	3121	1.1	K20TT	IK20TT	IK20TT	4
1.6 All-wheel Drive	73/78	M16A	OEM Optional	04/05-	VK20	5604	1.1	-	IK20TT	IK20TT	4
1.9 DDiS	95	F9QB	Ch: > 0061000, OE: 18550-84A51	10/05-	DG-005		11V				4
2.0 All-wheel Drive	103	J20A		10/05-	K20PR-U11	3121	1.1	K20TT	IK20TT	IK20TT	4
2.0 All-wheel Drive	103	J20A	OEM Optional	10/05-	SK16PR-A11	3356	1.1	-	IK16TT	IK16TT	4
2.0 HDi All-wheel Drive	80	RHW		01/06-	DG-116		11V				4
2.4 All-wheel Drive	122/ 124	J24B		01/09-	K16HPR-U11	6076	1.1	KH16TT	IKH16TT	IKH16TT	4
2.4 All-wheel Drive	122/ 124	J24B	OEM Optional	01/09-	VKH20	5618	1.1	-	IKH20TT	IKH20TT	4
2.7 All-wheel Drive	135/ 138	H 27 A	OEM Optional	01/07-	VK20	5604	1.1	-	IK20TT	IK20TT	6
3.2 All-wheel Drive	171	N32A		01/09-	PT16VR13	5068	1.3	TV16TT	ITV16TT	ITV16TT	6
IGNIS I (00-03)											
1.3	61	M13A		10/00-09/03	K20PR-U11	3121	1.1	K20TT	IK20TT	IK20TT	4
1.3	61	M13A	LEAN BURN	10/00-09/03	SK20PR-A11	3418	1.1	-	IK20TT	IK20TT	4
1.3 4WD	61	M13A		10/00-09/03	K20PR-U11	3121	1.1	K20TT	IK20TT	IK20TT	4
1.3 4WD	61	M13A	LEAN BURN	10/00-09/03	SK16PR-A11	3356	1.1	-	IK16TT	IK16TT	4
IGNIS II (03-)											
1.3	69	M13A		09/03-	VK20	5604	1.1	-	IK20TT	IK20TT	4
1.3 4x4	69	M13A		09/03-	VK20	5604	1.1	-	IK20TT	IK20TT	4
1.3 DDiS	51	Z13DT		09/03-	DG-171		11V				4
1.5	73	M15A		09/03-	VK20	5604	1.1	-	IK20TT	IK20TT	4
1.5 4x4	73	M15A		09/03-	VK20	5604	1.1	-	IK20TT	IK20TT	4
1.5 Sport	80	M15A		12/03-	VK20	5604	1.1	-	IK20TT	IK20TT	4
JIMNY (98-)											
1.3 16V	59	G13BB/E6		09/98-	K20PR-U	3145	0.8	K20TT	IK20TT	IK20TT	4
1.3 16V	60	M13A(81);M13A(85)		04/02-	VK20	5604	1.1	-	IK20TT	IK20TT	4
1.3 16V 4WD	59	G13BB/E6		09/98-	K20PR-U	3145	0.8	K20TT	IK20TT	IK20TT	4
1.3 16V 4WD	60	M13A(81)		04/02-	VK20	5604	1.1	-	IK20TT	IK20TT	4
1.3 16V 4x4	63	M13A(85)		08/05-	VK20	5604	1.1	-	IK20TT	IK20TT	4
1.5 DDiS 4WD	48	K9K 700		12/03-	DG-005		11V				4
1.5 DDiS 4x4	63	K9K 266		08/05-	DG-005		11V				4
KIZASHI (10-)											
2.4	131/ 138	J24B		10/10-	VKH20	5618	1.1	-	IKH20TT	IKH20TT	4
2.4 4WD	138	J24B		04/12-	VKH20	5618	1.1	-	IKH20TT	IKH20TT	4
2.4 4x4	131	J24B		10/10-	VKH20	5618	1.1	-	IKH20TT	IKH20TT	4









Spark & Glow Plugs

Application Tables









	KW					Standard			Twin Tip			QTY
SUZUKI <i>continued</i>												
LIANA (01-)												
1.3	66	M13A(90)		07/01-01/06	SK20PR-A11	3418	1.1	-	IK20TT	IK20TT		4
1.3	66	M13A(90)		03/02-01/06	VK20	5604	1.1	-	IK20TT	IK20TT		4
1.4 DDIS	66	8HY		04/04-01/06	DG-113		11V					4
1.6	76	M16A		07/01-	K20PR-U11	3121	1.1	K20TT	IK20TT	IK20TT		4
1.6	76/79	M16A(107); M16A		02/04-	VK20	5604	1.1	-	IK20TT	IK20TT		4
1.6 4WD	76/78	M16A		03/02-01/04	K20PR-U11	3121	1.1	K20TT	IK20TT	IK20TT		4
1.6 4WD	76/78/79	M16A(107); M16A		02/04-	VK20	5604	1.1	-	IK20TT	IK20TT		4
1.6 i	78	M16A		04/02-01/04	K20PR-U11	3121	1.1	K20TT	IK20TT	IK20TT		4
1.6 i	78	M16A		02/04-	VK20	5604	1.1	-	IK20TT	IK20TT		4
1.8 i	92	M18A		01/04-01/06	VK20	5604	1.1	-	IK20TT	IK20TT		4
LJ 80 (80-84)												
0.8	29	F8A		01/80-01/81	W16EPR-U	3021	0.8	W16TT	IW16TT	IW16TT		4
SAMURAI (88-04)												
1.0 All-wheel Drive (SJ 410)	33	F10A		11/88-12/04	W16EPR-U	3021	0.8	W16TT	IW16TT	IW16TT		4
1.3	52	G13BA		11/88-03/98	W20EXR-U	3066	0.8	W20TT	IW20TT	IW20TT		4
1.3 (SJ 413)	47	G13A		11/88-12/04	W16EPR-U	3021	0.8	W16TT	IW16TT	IW16TT		4
1.3 All-wheel Drive	59	G13BA		01/00-12/04	W20EXR-U	3066	0.8	W20TT	IW20TT	IW20TT		4
1.3 All-wheel Drive (SJ 413)	44	G13A		11/88-12/04	W16EPR-U	3021	0.8	W16TT	IW16TT	IW16TT		4
1.3 All-wheel Drive (SJ 413)	51	G13BA		11/88-12/04	W20EXR-U	3066	0.8	W20TT	IW20TT	IW20TT		4
1.9 TD	46	XUD9		11/98-12/04	DG-001		11V					4
SJ 410 (81-88)												
1.0 (SJ410)	33	F10A		09/81-12/88	W16EPR-U	3021	0.8	W16TT	IW16TT	IW16TT		4
SJ 413 (84-90)												
1.3	44/47	G13A		09/84-08/90	W16EPR-U	3021	0.8	W16TT	IW16TT	IW16TT		4
SOLIO (11-)												
1.2	67	K12B		06/11-	ZXU20PR11	3452	1.1	-	-	VXU22		4
1.2 4WD	67	K12B		06/11-	ZXU20PR11	3452	1.1	-	-	VXU22		4
SPLASH (08-)												
1.0	48/50	K10B		01/08-	ZXU20PR11	3452	1.1	-	-	VXU22		3
1.2	63	K12B		01/08-	ZXU20PR11	3452	1.1	-	-	VXU22		4
1.2 VVT	66/67/69	K12B		09/10-	ZXU20PR11	3452	1.1	-	-	VXU22		4
1.3 CDTI	55	Z13DTJ		01/08-	DG-171		11V					4
SUPER CARRY (85-99)												
1.0	30	F10A		09/94-03/99	W16EP-U	3018	0.8	W16TT	IW16TT	IW16TT		4
1.0 (SK)	33	F10A		10/85-03/99	W16EPR-U	3021	0.8	W16TT	IW16TT	IW16TT		4
SWIFT I (83-89)												
1.3 (SA413, AA51)	50	G13DOHC		10/84-01/88	W20EPR-U	3047	0.8	W20TT	IW20TT	IW20TT		4
1.3 (SA413, AA53)	47	G13DOHC		08/86-01/88	W20EPR-U	3047	0.8	W20TT	IW20TT	IW20TT		4
SWIFT II (89-05)												
1.0 (SF310, AA44)	37	G10A	Check Hex size	09/96-05/01	K20P-U	3276	0.8	K20TT	IK20TT	IK20TT		3
1.0 (SF310, AA44)	37	G10A	Check Hex size	03/89-08/96	W20EPR-U	3047	0.8	W20TT	IW20TT	IW20TT		3
1.0 i (SF310, AA44)	39	G10A	Check Hex size	09/96-12/05	K20P-U	3276	0.8	K20TT	IK20TT	IK20TT		3
1.0 i (SF310, AA44)	39/40	G10A	Check Hex size	03/89-08/96	W20EPR-U	3047	0.8	W20TT	IW20TT	IW20TT		3
1.3	51/63	G13B; G13BB	HUP	09/96-12/03	W20EPR-U	3047	0.8	W20TT	IW20TT	IW20TT		4
1.3 (SF413, AB35)	50	G13B; G13BA - EU; G13B; G13BAK		03/89-05/01	W20EPR-U	3047	0.8	W20TT	IW20TT	IW20TT		4
1.3 (SF413, AH35)	52	G13BA - EU	JJP	03/89-12/91	W20EPR-U	3047	0.8	W20TT	IW20TT	IW20TT		4
1.3 (SF413, AH35, MA)	50	G13BAK	HUP	01/95-08/96	W20EPR-U	3047	0.8	W20TT	IW20TT	IW20TT		4
1.3 (SF413, AH35, MA)	50	G13B	JJP	04/92-08/96	W20EPR-U	3047	0.8	W20TT	IW20TT	IW20TT		4
1.3 4WD (SF413, AF35)	52	G13BAK4WD	JJP	10/89-12/91	W20EPR-U	3047	0.8	W20TT	IW20TT	IW20TT		4
1.3 GTi (SF413, AA34)	74	G13BDOHC; G13DOHC	JJP	03/89-08/96	W20EPR-U	3047	0.8	W20TT	IW20TT	IW20TT		4
1.3 i (SF413, AK35)	50	G13B		09/91-10/96	W20EPR-U	3047	0.8	W20TT	IW20TT	IW20TT		4
1.6 (SF416, AH14)	70	G16B		11/89-12/91	K20P-U	3276	0.8	K20TT	IK20TT	IK20TT		4
1.6 4WD (SF416, AJ14)	70	G16B		11/89-12/91	K20P-U	3276	0.8	K20TT	IK20TT	IK20TT		4
1.6 4x4	68	G16B		03/89-10/96	K20P-U	3276	0.8	K20TT	IK20TT	IK20TT		4
1.6 i (SF416, AH14)	68	G16B		01/90-05/01	K20P-U	3276	0.8	K20TT	IK20TT	IK20TT		4
1.6 i 4WD (SF416, AJ14)	68	G16B		01/90-05/01	K20P-U	3276	0.8	K20TT	IK20TT	IK20TT		4
SWIFT III (05-)												
1.3	68	M13AVVT(93)		02/05-01/11	VK20	5604	1.1	-	IK20TT	IK20TT		4
1.3 4x4	66	M13A		01/06-	VK20	5604	1.1	-	IK20TT	IK20TT		4
1.3 4x4	68	M13AVVT(93)	JJP	03/06-01/11	VK20	5604	1.1	-	IK20TT	IK20TT		4
1.3 DDIS	51/55	Z13DT; Z13DTJ		08/05-	DG-171		11V					4

Spark & Glow Plugs

Application Tables







	KW									QTY	
SUZUKI <i>continued</i>											
SWIFT III (05-) <i>continued</i>											
1.5	75	M15(109)	HUP, JJP	02/05-09/10	VK20	5604	1.1	-	IK20TT	IK20TT	4
1.5 4x4	74	M15(109)	HUP, JJP	02/05-09/10	VK20	5604	1.1	-	IK20TT	IK20TT	4
1.6	92	M16A		05/06-09/11	VK20	5604	1.1	-	IK20TT	IK20TT	4
SWIFT IV (10-)											
1.2	66/ 67/ 69	K12B		10/10-07/13	ZXU20PR11	3452	1.1	-	-	VXU22	4
1.2 4WD	67	K12B		08/12-07/13	ZXU20PR11	3452	1.1	-	-	VXU22	4
1.2 4x4	66/69	K12B		10/10-07/13	ZXU20PR11	3452	1.1	-	-	VXU22	4
1.6	100	M16A		01/12-	SK20HR11	3421	1.1	-	IKH20TT	IKH20TT	4
SX4 (06-)											
1.5	73	M15A	HUP	06/06-06/09	K16HPR-U11	6076	1.1	KH16TT	IKH16TT	IKH16TT	4
1.5	73	M15A	JJP	06/06-06/09	VK20	5604	1.1	-	IK20TT	IK20TT	4
1.5 VVT	82	M15A		07/10-	VK20	5604	1.1	-	IK20TT	IK20TT	4
1.6	74/ 75/ 79/ 88	M16A		06/06-	VK20	5604	1.1	-	IK20TT	IK20TT	4
1.6 DDIS	66	9HX		04/07-	DG-113		11V				4
1.6 VVT	79/88	M16A		06/06-	VK20	5604	1.1	-	IK20TT	IK20TT	4
1.6 VVT 4x4	79/ 82/ 88	M16A		06/06-	VK20	5604	1.1	-	IK20TT	IK20TT	4
1.9 DDIS	88	D19AA		06/06-	DG-196		11V				4
1.9 DDIS 4x4	88	D19AA		06/06-	DG-196		11V				4
2.0	107	J20A		06/06-	K16HPR-U11	6076	1.1	KH16TT	IKH16TT	IKH16TT	4
2.0 4x4	107	J20A		06/06-	K16HPR-U11	6076	1.1	KH16TT	IKH16TT	IKH16TT	4
2.0 DDIS	99	D20AA		07/09-	DG-608		4.4V				4
2.0 DDIS 4x4	99	D20AA		07/09-	DG-608		4.4V				4
SX4 S-Cross (13-)											
1.6	86/88	M16A		08/13-	SK20HR11	3421	1.1	-	IKH20TT	IKH20TT	4
1.6 DDIS	88			08/13-	DG-608		4.4V				4
VITARA (88-99)											
1.6	59	G16A		07/88-01/95	W16EPR-U	3021	0.8	W16TT	IW16TT	IW16TT	4
1.6 All-wheel Drive (ET)	60	G16A		07/88-12/91	W16EPR-U	3021	0.8	W16TT	IW16TT	IW16TT	4
1.6 All-wheel Drive (TA, TA01)	59	G16A		07/88-03/98	W16EPR-U	3021	0.8	W16TT	IW16TT	IW16TT	4
1.6 i 16V	71	G16B		07/90-03/99	K20PR-U	3145	0.8	K20TT	IK20TT	IK20TT	4
1.6 i 16V All-wheel Drive (ET, TA02)	71	G16B		07/90-03/98	K20PR-U	3145	0.8	K20TT	IK20TT	IK20TT	4
1.9 D (ET)	50/55	XUD9A; XUD9SD		01/95-03/99	DG-001		11V				4
1.9 D All-wheel Drive (ET)	50/55	XUD9A; XUD9SD		01/95-03/98	DG-001		11V				4
2.0 16V	97	J20A		12/96-03/99	K20PR-U	3145	0.8	K20TT	IK20TT	IK20TT	4
2.0 16V All-wheel Drive (ET, TA51)	97	J20A		12/96-03/98	K20PR-U	3145	0.8	K20TT	IK20TT	IK20TT	4
2.0 TD All-wheel Drive (ET)	52	RF		12/94-03/98	DG-116		11V				4
2.0 TD All-wheel Drive (ET)	52	RF		12/94-03/98	DG-146		11V				4
2.0 TD Intercooler All-wheel Drive (ET)	64	RF		12/95-03/98	DG-116		11V				4
2.0 TD Intercooler All-wheel Drive (ET)	64	RF		12/95-03/98	DG-146		11V				4
2.0 V6 24V All-wheel Drive (ET)	100	H 20 A		12/94-03/98	K20PR-U	3145	0.8	K20TT	IK20TT	IK20TT	6
2.5 V6 24V All-wheel Drive (FT)	118	H 25 A		12/95-03/98	K20PR-U	3145	0.8	K20TT	IK20TT	IK20TT	6
VITARA (03-05)											
2.0 HDI	64	RHP (DW10TD)		12/03-12/05	DG-116		11V				4
HDI	64	RHP (DW10TD)		12/03-12/05	DG-116		11V				4
WAGON R (03-05)											
1.0	39	G10A		07/03-08/05	K20P-U	3276	0.8	K20TT	IK20TT	IK20TT	3
1.2	59	Z 12 XEP		06/04-08/05	KJ16CR-L11	3132	1.1	K16TT	IK16TT	IK16TT	4
WAGON R+ (98-00)											
1.0 (MA61)	48	K10A		02/98-05/00	XU22EPR-U	3179	0.9	XU22TT	-	VXU22	4
1.2	51	K12A		02/98-05/00	XU22EPR-U	3179	0.9	XU22TT	-	VXU22	4
1.2 4WD	51	K12A		02/98-05/00	XU22EPR-U	3179	0.9	XU22TT	-	VXU22	4
WAGON R+ (00-)											
1.3	56/69	G13BB; M13AVVT(93)		05/00-01/08	K20PR-U11	3121	1.1	K20TT	IK20TT	IK20TT	4
1.3 4WD	56	G13BB		10/01-01/08	K20PR-U11	3121	1.1	K20TT	IK20TT	IK20TT	4
1.3 4WD	69	M13AVVT(93)		09/03-01/08	W20EPR-U11	3049	1.1	W20TT	IW20TT	IW20TT	4
1.3 DDIS	51	Z13DT		09/03-	DG-171		11V				4







KW	KW	KW	KW	KW	Standard			Twin Tip			QTY
					Standard	Standard	Standard	Twin Tip	Twin Tip	Twin Tip	
SUZUKI <i>continued</i>											
X-90 (95-97)											
1.6 i 16V 4x4	71	G16BA		09/95-12/97	K20PR-U	3145	0.8	K20TT	IK20TT	IK20TT	4
TALBOT											
180 (73-82)											
1.9 D	44			01/82-12/82	DG-001		11V				4
1307-1510 (75-84)											
1510 1.6	66	J2;J2A		07/81-06/82	W20EPR-U	3047	0.8	W20TT	IW20TT	IW20TT	4
Simca 1307 1.3	40/ 44/ 50	G1; G1D		07/75-01/80	W20EPR-U	3047	0.8	W20TT	IW20TT	IW20TT	4
Simca 1307 1.3S	60	G1		07/75-12/78	W20EPR-U	3047	0.8	W20TT	IW20TT	IW20TT	4
Simca 1308 1.4	55/63	Y2		11/78-07/79	W20EPR-U	3047	0.8	W20TT	IW20TT	IW20TT	4
Simca 1510 1.4	51/ 55/ 63	Y1;Y2		01/80-01/82	W20EPR-U	3047	0.8	W20TT	IW20TT	IW20TT	4
Simca 1510 1.6	54/65	J2;J2A		10/78-01/82	W20EPR-U	3047	0.8	W20TT	IW20TT	IW20TT	4
EXPRESS 1000 -1500 (82-94)											
1.9 D	51	XUD9A		07/87-10/90	DG-001		11V				4
2.5 D	54	CRD93		07/82-10/94	DG-001		11V				4
2.5 D All-wheel Drive	54	CRD93		11/88-10/94	DG-001		11V				4
2.5 TD	70	CRD93LS		06/87-10/94	DG-001		11V				4
2.5 TD All-wheel Drive	70	CRD93LS		11/88-10/94	DG-001		11V				4
EXPRESS 1000 -1800 (81-94)											
1.9 D	51	XUD9A		07/87-10/90	DG-001		11V				4
HORIZON (78-86)											
1.1	40/43	E1B		01/79-09/84	W20EPR-U	3047	0.8	W20TT	IW20TT	IW20TT	4
1.3	40/ 43/ 47/ 50	2G1-BTC; G1/BTC		07/79-06/86	W20EPR-U	3047	0.8	W20TT	IW20TT	IW20TT	4
1.4	48/ 51/ 61	2Y1; 2Y2; Y1;Y1B; Y2, Y2S; Y2		07/79-06/86	W20EPR-U	3047	0.8	W20TT	IW20TT	IW20TT	4
1.6	66	J1B;J2A; J2S		07/82-06/86	W20EPR-U	3047	0.8	W20TT	IW20TT	IW20TT	4
1.9 Diesel	47/48	XUD9		07/82-06/86	DG-001		11V				4
MURENA (80-85)											
1.6	66	J2		08/81-01/83	W20EPR-U	3047	0.8	W20TT	IW20TT	IW20TT	4
2.1	85	N2		01/82-01/83	W20EPR-U	3047	0.8	W20TT	IW20TT	IW20TT	4
RANCHO (77-84)											
1.4	59	Y2		01/77-07/84	W20EPR-U	3047	0.8	W20TT	IW20TT	IW20TT	4
SAMBA (81-86)											
0.9	31	XV5;XV8		01/81-12/85	T20EPR-U	5032	0.8	T20TT	IT20TT	IT20TT	4
1.1	37	XW7		01/81-01/85	T20EPR-U	5032	0.8	T20TT	IT20TT	IT20TT	4
1.2 Rallye	65	XZ7R		01/83-01/85	T20EPR-U	5032	0.8	T20TT	IT20TT	IT20TT	4
1.4	44/ 53/ 58	XY6B;XY7; XY8		01/83-01/85	T20EPR-U	5032	0.8	T20TT	IT20TT	IT20TT	4
1.4 Rallye	58	XY6		01/83-10/86	T20EPR-U	5032	0.8	T20TT	IT20TT	IT20TT	4
SIMCA (1609, 1610) (76-80)											
1610 2.0 D	44			09/76-12/80	DG-001		11V				4
SOLARA (80-86)											
1.3	40	G1D		02/80-01/83	W20EPR-U	3047	0.8	W20TT	IW20TT	IW20TT	4
1.6	51/ 54/ 65/ 66	J1;J1A; J1A; J2A;J1; J2A		09/81-01/85	W20EPR-U	3047	0.8	W20TT	IW20TT	IW20TT	4
TAGORA (80-87)											
2.1	85	N2		06/80-12/83	W20EPR-U	3047	0.8	W20TT	IW20TT	IW20TT	4
2.3 Turbo Diesel	59	XD2S		08/81-12/83	DG-001		11V				4
2.6	122	9L6		08/81-10/83	T20EPR-U	5032	0.8	T20TT	IT20TT	IT20TT	6
TATA											
INDICA (98-)											
1.4 i	55	475 Si		10/98-	K20PR-U	3145	0.8	K20TT	IK20TT	IK20TT	4
LOADBETA (94-06)											
1.9 D	50/66			08/94-12/06	DG-001		11V				4
1.9 D All-wheel Drive	66			11/95-12/06	DG-001		11V				4
TOFAS											
DOGAN (76-02)											
1.6	59			01/76-05/92	W20EPR-U	3047	0.8	W20TT	IW20TT	IW20TT	4
1.6	59			06/92-12/01	W22EPR-U	3088	0.8	W22TT	-	VW22	4
1.6 i.e	61			01/99-12/02	W22EPR-U	3088	0.8	W22TT	-	VW22	4
1.6 IE	66			01/97-07/02	W22EPR-U	3088	0.8	W22TT	-	VW22	4

	KW					Standard			Twin Tip		QTY
TOFAS <i>continued</i>											
KARTAL (91-)											
1.6	55			01/91-05/92	W20EPR-U	3047	0.8	W20TT	IW20TT	IW20TT	4
1.6	55			06/92-	W22EPR-U	3088	0.8	W22TT	-	VW22	4
1.6 IE	66			01/97-07/02	W22EPR-U	3088	0.8	W22TT	-	VW22	4
SAHIN (80-03)											
1.4 Mirafiori	51			01/80-12/03	W20EPR-U	3047	0.8	W20TT	IW20TT	IW20TT	4
1.6 IE	63			01/97-07/02	W22EPR-U	3088	0.8	W22TT	-	VW22	4
1.6 S	59			01/80-05/92	W20EPR-U	3047	0.8	W20TT	IW20TT	IW20TT	4
1.6 S	59			06/92-12/03	W22EPR-U	3088	0.8	W22TT	-	VW22	4
TOYOTA											
4 RUNNER (N10) (89-96)											
2.4 TD	66	2L-T		08/89-11/95	DG-211		11V				4
2.7 i	112	3RZ-FE		11/95-03/96	K16R-U	3119	0.8	K16TT	IK16TT	IK16TT	4
3.0 Turbo-D (KZN 130)	92	1KZ-T		10/93-03/96	DG-211		11V				4
3.0 V6 (VZN 130)	105	3VZ-E		07/90-11/95	K16R-U	3119	0.8	K16TT	IK16TT	IK16TT	6
3.4 i	136	5VZ-FE		11/95-03/96	K16TR11	3194	1.1	K16TT	IK16TT	IK16TT	6
4 RUNNER (N18) (95-02)											
3.0 Turbo-D	92	1KZ-T		11/95-11/02	DG-305		11V				4
4.0 VVTi	183	1GR-FE		08/02-11/02	K20HR-U11	3381	1.1	KH20TT	IKH20TT	IKH20TT	6
4 RUNNER (N5) (87-89)											
2.4 4WD	82	22REC		08/87-07/89	W16EXR-U	3031	0.8	W16TT	IW16TT	IW16TT	4
1000 (69-88)											
1.0	33	2K		04/69-08/88	W20EP-U	3043	0.8	W20TT	IW20TT	IW20TT	4
ALLION I (01-07)											
1.5	80	1NZ-FE		06/01-04/05	K16R-U11	3120	1.1	K16TT	IK16TT	IK16TT	4
1.8	100	2ZR-FE		06/01-06/07	SC20HR11	3444	1.1	-	IXEH22TT	IXEH22TT	4
1.8 4WD	100	2ZR-FE		06/01-06/07	SC20HR11	3444	1.1	-	IXEH22TT	IXEH22TT	4
ALLION II (07-)											
1.5	81	1NZ-FE		07/07-	VFKH16	5654	1.1	-	IKH16TT	IKH16TT	4
1.8	106	2ZR-FAE		07/07-	SC20HR11	3444	1.1	-	IXEH22TT	IXEH22TT	4
1.8 4WD	98	2ZR-FAE		07/07-	SC20HR11	3444	1.1	-	IXEH22TT	IXEH22TT	4
ALPHARD I (03-08)											
3.0	162	1MZ-FE		04/03-04/08	SK20R11	3297	1.1	-	IK20TT	IK20TT	6
3.0 4WD	162	1MZ-FE		04/03-04/08	SK20R11	3297	1.1	-	IK20TT	IK20TT	6
ALPHARD II (08-)											
2.4	125	2AZ-FE		04/08-	SK20R11	3297	1.1	-	IK20TT	IK20TT	4
2.4 4WD	125	2AZ-FE		04/08-	SK20R11	3297	1.1	-	IK20TT	IK20TT	4
3.5	202/ 206	2GR-FE		04/08-	FK20HR11	3426	1.1	-	IKH20TT	IKH20TT	6
3.5 4WD	206	2GR-FE		04/08-	FK20HR11	3426	1.1	-	IKH20TT	IKH20TT	6
ALTEZZA (99-05)											
2.0	114	1G-FE; 1G-GE		01/99-07/05	SK20R-P11	3335	1.1	-	IK20TT	IK20TT	6
2.0 VVTi	147	3S-GE		02/99-07/05	PK22PR-L11S	3284	1.1	-	-	VK22G	4
2.0 VVTi	118	1G-FE		01/99-07/05	SK20R-P11	3335	1.1	-	IK20TT	IK20TT	6
3.0	157	2JZ-GE		07/01-07/05	SK20R-P11	3335	1.1	-	IK20TT	IK20TT	6
AQUA (11-)											
1.5 Hybrid	54	1NZ-FXE		12/11-05/13	FK16R-A8		0.8	-	-	VFK16	4
AURION (00-11)											
3.5	235	2GR-FSE		03/06-09/11	FK20HR11	3473	1.1	-	IKBH20TT	IKBH20TT	6
3.5	200	2GR-FE		03/06-09/11	FK20HR11	3426	1.1	-	IKH20TT	IKH20TT	6
AURION (11-)											
3.5	200	2GR-FE		09/11-	FK20HR11	3426	1.1	-	IKH20TT	IKH20TT	6
AURIS (06-)											
1.33 Dual-VVTi	73/74	1NR-FE		05/09-	SC20HR11	3444	1.1	-	IXEH22TT	IXEH22TT	4
1.4 D-4D	66	1ND-TV		03/07-04/13	DG-240		11V				4
1.4 VVTi	71	4ZZ-FE		03/07-	K16R-U11	3120	1.1	K16TT	IK16TT	IK16TT	4
1.5	81	1NZ-FE		09/09-	VFKH16	5654	1.1	-	IKH16TT	IKH16TT	4
1.5 4WD	77	1NZ-FE		09/09-	VFKH16	5654	1.1	-	IKH16TT	IKH16TT	4
1.6	97	1ZR-FAE		05/09-	SC20HR11	3444	1.1	-	IXEH22TT	IXEH22TT	4
1.6 VVTi	91	1ZR-FE		03/07-	SC20HR11	3444	1.1	-	IXEH22TT	IXEH22TT	4
1.8	106/ 108	2ZR-FAE		02/09-	SC20HR11	3444	1.1	-	IXEH22TT	IXEH22TT	4
1.8 4WD	100	2ZR-FAE		02/09-	SC20HR11	3444	1.1	-	IXEH22TT	IXEH22TT	4
1.8 Hybrid	73	2ZR-FXE		09/10-	SC20HR11	3444	1.1	-	IXEH22TT	IXEH22TT	4
1.8 VVTi	100	2ZR-FE		10/06-	SC20HR11	3444	1.1	-	IXEH22TT	IXEH22TT	4
2.0 D-4D	93	1AD-FTV		03/07-	DG-600		11V				4
2.2 D	130	2AD-FHV		03/07-	DG-600		11V				4
2.4 VVTi	123	2AZ-FE		04/07-	SK20R11	3297	1.1	-	IK20TT	IK20TT	4
2.4 VVTi 4WD	123	2AZ-FE		04/07-	SK20R11	3297	1.1	-	IK20TT	IK20TT	4

Spark & Glow Plugs



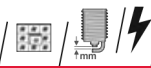



Application Tables

	KW					Standard			Twin Tip			QTY
TOYOTA <i>continued</i>												
AURIS (06-) <i>continued</i>												
3.5 VVTi 4WD	206	2GR-FE		04/07-	FK20HR11	3426	1.1	-		IKH20TT	IKH20TT	6
AURIS (12-)												
1.3	73	1NR-FE		11/13-	SC16HR11	3499	1.1	-		IXEH20TT	IXEH20TT	4
1.3	73	1NR-FE		10/12-11/13	SC20HR11	3444	1.1	-		IXEH22TT	IXEH22TT	4
1.4 D-4D	66	1ND-TV		10/12-	DG-240		11V					4
1.5	80	1NZ-FE		10/12-	VFKH16	5654	1.1	-		IKH16TT	IKH16TT	4
1.5 4WD	77	1NZ-FE		10/12-	VFKH16	5654	1.1	-		IKH16TT	IKH16TT	4
1.6	97	1ZR-FAE		10/12-	SC20HR11	3444	1.1	-		IXEH22TT	IXEH22TT	4
1.8	103/ 106	2ZR-FAE		10/12-	SC20HR11	3444	1.1	-		IXEH22TT	IXEH22TT	4
1.8 Hybrid	73	2ZR-FXE		10/12-	SC20HR11	3444	1.1	-		IXEH22TT	IXEH22TT	4
AVALON (95-05)												
3.0	140	1MZ-FE		03/95-05/05	K20TR11	3195	1.1		K20TT	IK20TT	IK20TT	6
3.0	140	1MZ-FE	OEM Optional	03/95-05/05	PK20TR11	3253	1.1		K20TT	IK20TT	IK20TT	6
AVALON (99-05)												
3.0	137/ 145/ 157	1MZ-FE		09/99-04/05	SK20R11	3297	1.1	-		IK20TT	IK20TT	6
AVALON (05-)												
3.5 VVTi	206	2GR-FE		01/05-	FK20HR11	3426	1.1	-		IKH20TT	IKH20TT	6
AVENSIS (97-03)												
1.6 (AT220_)	81	4A-FE		09/97-10/00	K20R-U	3122	0.8		K20TT	IK20TT	IK20TT	4
1.6 (AT220_)	74	4A-FE		09/97-10/00	PK20R13	3226	1.3		K20TT	IK20TT	IK20TT	4
1.6 (AT220_)	81	4A-FE	LEAN BURN	09/97-10/00	SK20R-P13	3298	1.3	-		IK20TT	IK20TT	4
1.6 VVT-i	81	3ZZ-FE		10/00-02/03	K16R-U11	3120	1.1		K16TT	IK16TT	IK16TT	4
1.8 (AT221_)	81	7A-FE	LEAN BURN	09/97-10/00	SK20R-P13	3298	1.3	-		IK20TT	IK20TT	4
1.8 VVT-i	95	1ZZ-FE		10/00-02/03	K16R-U11	3120	1.1		K16TT	IK16TT	IK16TT	4
2.0 (ST220_)	94	3S-FE		07/00-10/00	K20TR11	3195	1.1		K20TT	IK20TT	IK20TT	4
2.0 (ST220_)	94	3S-FE	OEM Optional	09/97-10/00	PK20TR11	3253	1.1		K20TT	IK20TT	IK20TT	4
2.0 D	61	2C-T		10/97-05/98	DG-214		11V					4
2.0 D	85	1CD-FTV		09/02-02/03	DG-245		11V					4
2.0 D-4D (CDT220_)	81	1CD-FTV		10/99-02/03	DG-245		11V					4
2.0 TD (CT220_)	66	2C-TE		09/97-02/03	DG-214		11V					4
2.0 VVT-i	110	1AZ-FSE		10/00-02/03	SK20BR11	3471	1.1	-			VKB20	4
AVENSIS (03-09)												
1.6 VVT-i	81	3ZZ-FE		04/03-11/08	K16R-U11	3120	1.1		K16TT	IK16TT	IK16TT	4
1.8	95	1ZZ-FE		04/03-11/08	K16R-U11	3120	1.1		K16TT	IK16TT	IK16TT	4
2.0	108	1AZ-FSE		04/03-12/09	SK20BR11	3471	1.1	-			VKB20	4
2.0 D-4D	85	1CD-FTV		04/03-11/08	DG-245		11V					4
2.0 D-4D	93	1AD-FTV		03/06-11/08	DG-600		11V					4
2.0 VVTi	114	1AZ-FE		04/03-11/08	SK20R11	3297	1.1	-		IK20TT	IK20TT	4
2.2 D-4D	110	2AD-FTV		10/05-11/08	DG-600		11V					4
2.2 D-CAT	130	2AD-FHV		07/05-11/08	DG-600		11V					4
2.4	120/ 125	2AZ-FSE		09/03-11/08	SK20BR11	3471	1.1	-			VKB20	4
AVENSIS (09-)												
1.6	97	1ZR-FAE		02/09-	SC20HR11	3444	1.1	-		IXEH22TT	IXEH22TT	4
1.8	108	2ZR-FAE		02/09-	SC20HR11	3444	1.1	-		IXEH22TT	IXEH22TT	4
2.0	112	3ZR-FAE; 3ZR-FE		02/09-	SC20HR11	3444	1.1	-		IXEH22TT	IXEH22TT	4
2.0 D-4D	91/93	1AD-FTV		02/09-	DG-600		11V					4
2.2 D-4D	110/ 130	2AD-FHV; 2AD-FTV		02/09-	DG-600		11V					4
AVENSIS Verso (01-09)												
2.0 D-4D	85	1CD-FTV		08/01-08/05	DG-245		11V					4
2.0 VVT-i	110	1AZ-FE		08/01-11/09	SK20R11	3297	1.1	-		IK20TT	IK20TT	4
2.4 VVTi 4WD	115	2AZ-FE		11/03-08/06	SK20R11	3297	1.1	-		IK20TT	IK20TT	4
2.4 VVTi GLS	115	2AZ-FE		10/03-11/09	SK20R11	3297	1.1	-		IK20TT	IK20TT	4
AYGO (05-)												
1.0 (KGB10)	50	1KR-FE		07/05-04/14	K16HR-U11	3482	1.1		KH16TT	IKH16TT	IKH16TT	3
1.0 (KGB10)	50	1KR-FE		05/14-	SC16HR11	3499	1.1	-		IXEH20TT	IXEH20TT	3
1.0 GPL	50	1KR-FE		05/14-	SC16HR11	3499	1.1	-		IXEH20TT	IXEH20TT	3
1.0 GPL	50	1KR-FE	LPG / GPL	07/05-04/14	SK16HR11	3417	1.1	-		IKH16TT	IKH16TT	3
1.4 HDi (WNB10)	40	2WZ-TV		07/05-08/10	DG-113		11V					4
AYGO (14-)												
1.0	51	1KR-FE		05/14-	SC16HR11	3499	1.1	-		IXEH20TT	IXEH20TT	3
1.0 VVT-i (KGB40)	51	1KR-FE		05/14-	SC16HR11	3499	1.1	-		IXEH20TT	IXEH20TT	3
bB (00-05)												
1.5	80	1NZ-FE		03/00-12/05	K16R-U11	3120	1.1		K16TT	IK16TT	IK16TT	4

	KW								QTY		
TOYOTA <i>continued</i>											
CALDINA (92-97)											
1.6	75	4A-FE		02/92-09/97	PK16TR13	3350	1.3	K16TT	IK16TT	IK16TT	4
1.8	79	7A-FE		02/92-09/97	PK16TR13	3350	1.3	K16TT	IK16TT	IK16TT	4
CALDINA (97-01)											
1.8	85	7A-FE		10/97-09/01	PK16TR13	3350	1.3	K16TT	IK16TT	IK16TT	4
CALDINA (02-07)											
2.0	112	1AZ-FSE		09/02-06/07	VK20Y	5620	0.8	-	-	VK20Y	4
CAMI (99-05)											
1.3	63/66	K3-VE		06/99-12/05	K20TNR-S	3196	1.0	K20TT	IK20TT	IK20TT	4
1.3 4WD	61/63	HC-EJ; K3-VE		05/99-12/05	K20TNR-S	3196	1.0	K20TT	IK20TT	IK20TT	4
1.3 4WD	103	K3-VET		06/99-12/05	VK20Y	5620	0.8	-	-	VK20Y	4
CAMRY (83-88)											
1.8	66	1S-L		02/83-10/86	W16EXR-U	3031	0.8	W16TT	IW16TT	W16TT	4
1.8 Turbo-D	54	1C-TL		11/83-01/88	DG-223		7V				4
2.0	78	2S-EL		01/83-12/87	W16EXR-U	3031	0.8	W16TT	IW16TT	W16TT	4
2.0	73	2S-ELC		04/86-01/88	W16EXR-U11	3032	1.1	W16TT	IW16TT	W16TT	4
2.0 GLI	79	2S-EL		03/83-10/86	W16EXR-U	3031	0.8	W16TT	IW16TT	W16TT	4
2.0 GLI 4WD	88	3S-FE		03/83-07/86	K20R-U11	3139	1.1	K20TT	IK20TT	IK20TT	4
2.0 TD	62	2C-TL		09/85-10/86	DG-223		7V				4
CAMRY (86-91)											
1.8 (SV20_)	66	1S		11/86-08/88	W16EXR-U	3031	0.8	W16TT	IW16TT	W16TT	4
1.8 i (SV20_)	66	1S-L		10/86-08/88	W16EXR-U	3031	0.8	W16TT	IW16TT	W16TT	4
2.0 (SV21_)	94	3S-FE		11/86-05/91	Q20R-U11	3009	1.1	Q20TT	IQ20TT	IQ20TT	4
2.0 (SV21_, SV25_)	94	3S-FE		11/86-05/91	Q20R-U11	3009	1.1	Q20TT	IQ20TT	IQ20TT	4
2.0 4WD	94	3S-FE		08/88-05/91	Q16R-U11	3006	1.1	Q16TT	IQ16TT	IQ16TT	4
2.0 GLi 16V (SV21_)	89	3S-FE		11/86-05/91	Q16R-U11	3006	1.1	Q16TT	IQ16TT	IQ16TT	4
2.0 GLi 16V (SV21_, SV25_)	89	3S-FE		11/86-05/91	Q16R-U11	3006	1.1	Q16TT	IQ16TT	IQ16TT	4
2.0 Turbo-D (CV20_)	62/63	2C-T		08/88-05/91	DG-214		11V				4
2.0 Turbo-D (CV20_)	62/63	2C-T		11/86-05/91	DG-223		7V				4
2.5 (VZV21_)	118	2VZ-FE		01/90-05/91	PQ20R	3117	1.1	Q20TT	IQ20TT	IQ20TT	6
2.5 V6 GXI (VZV21_)	118	2VZ-FE		02/88-05/91	PQ20R	3117	1.1	Q20TT	IQ20TT	IQ20TT	6
CAMRY (90-97)											
2.2	93	5S-FE		02/93-04/95	PK20TR11	3253	1.1	K20TT	IK20TT	IK20TT	4
2.2 (SXV10)	100	5S-FE		06/91-08/96	PK20TR11	3253	1.1	K20TT	IK20TT	IK20TT	4
3.0	135	1MZ-FE		09/93-07/96	K20TR11	3195	1.1	K20TT	IK20TT	IK20TT	6
3.0	135	1MZ-FE	OEM Optional	09/93-07/96	PK20TR11	3253	1.1	K20TT	IK20TT	IK20TT	6
3.0 (VCV10)	138	3VZ-FE		06/91-08/96	PQ20R	3117	1.1	Q20TT	IQ20TT	IQ20TT	6
CAMRY (96-01)											
2.2	93	5S-FE		11/00-11/01	PK20TR11	3253	1.1	K20TT	IK20TT	IK20TT	4
2.2 (SXV20_)	96	5S-FE		08/96-11/01	PK20TR11	3253	1.1	K20TT	IK20TT	IK20TT	4
3.0 (MCV20)	140	1MZ-FE		08/96-07/01	K20TR11	3195	1.1	K20TT	IK20TT	IK20TT	6
3.0 (MCV20)	140	1MZ-FE	OEM Optional	08/96-07/01	PK20TR11	3253	1.1	K20TT	IK20TT	IK20TT	6
3.0 24V (MCV20_)	140	1MZ-FE		08/96-11/01	K20TR11	3195	1.1	K20TT	IK20TT	IK20TT	6
3.0 24V (MCV20_)	140	1MZ-FE	OEM Optional	08/96-11/01	PK20TR11	3253	1.1	K20TT	IK20TT	IK20TT	6
3.0 V6	135	1MZ-FE		08/96-11/01	K20TR11	3195	1.1	K20TT	IK20TT	IK20TT	6
3.0 V6	135	1MZ-FE	OEM Optional	08/96-11/01	PK20TR11	3253	1.1	K20TT	IK20TT	IK20TT	6
CAMRY (01-06)											
2.4 VVT-i	112	2AZ-FE		11/01-11/06	SK20R11	3297	1.1	-	IK20TT	IK20TT	4
2.4 VVTi Hybrid	105	2AZ-FXE		01/06-11/06	SK20R11	3297	1.1	-	IK20TT	IK20TT	4
2.4 VVTi LE	116	2AZ-FE		01/06-11/06	SK20R11	3297	1.1	-	IK20TT	IK20TT	4
3.0	141	1MZ-FE		09/02-06/06	SK20R11	3297	1.1	-	IK20TT	IK20TT	6
3.0 V6	137	1MZ-FE		11/01-11/06	SK20R11	3297	1.1	-	IK20TT	IK20TT	6
3.3 VVTi	165	3MZ-FE		08/02-12/05	SK20R11	3297	1.1	-	IK20TT	IK20TT	6
3.5 VVTi XLE	197	2GR-FE		01/06-11/06	FK20HR11	3426	1.1	-	IKH20TT	IKH20TT	6
CAMRY (06-11)											
2.0 VVT-i	108	1AZ-FE		01/06-09/11	SK20R11	3297	1.1	-	IK20TT	IK20TT	4
2.4 VVTi	116/123	2AZ-FE		01/06-09/11	SK20R11	3297	1.1	-	IK20TT	IK20TT	4
2.4 VVTi Hybrid	105	2AZ-FXE		01/06-09/11	SK20R11	3297	1.1	-	IK20TT	IK20TT	4
2.4 VVT-i Hybrid	110	2AZ-FXE		01/06-09/11	SK20R11	3297	1.1	-	IK20TT	IK20TT	4
2.5 VVTi	129	2AR-FE		01/10-09/11	SK16HR11	3417	1.1	-	IKH16TT	IKH16TT	4
3.5	204	2GR-FE		01/08-09/11	FK20HR11	3426	1.1	-	IKH20TT	IKH20TT	6
3.5 VVTi XLE	197	2GR-FE		01/06-	FK20HR11	3426	1.1	-	IKH20TT	IKH20TT	6
CAMRY (11-)											
2.0	109	1AZ-FE		09/11-	SK20R11	3297	1.1	-	IK20TT	IK20TT	4
2.0 Hybrid	123	6AR-FSE		03/15-	FK16HBR-J8	3508	0.8	-	-	FK16HBR-J8	4
2.5 (ASV50)	133	2AR-FE		01/12-	SK16HR11	3417	1.1	-	IKH16TT	IKH16TT	4
2.5 Hybrid	118	2AR-FXE; 2JM		09/11-	FK16HR-A8		0.8	-	-	FK16HR-A8	4











Spark & Glow Plugs

Application Tables

	KW					Standard			Twin Tip				QTY	
TOYOTA <i>continued</i>														
CAMRY (11-) continued														
3.5	204	2GR-FE		09/11-	FK20HR11	3426	1.1	-		IKH20TT	IKH20TT			6
CAMRY SOLARA (98-01)														
2.2	100	5S-FE		06/98-06/01	PK20TR11	3253	1.1		K20TT	IK20TT	IK20TT			4
3.0	140/ 147	1MZ-FE		06/98-06/01	K20TR11	3195	1.1		K20TT	IK20TT	IK20TT			6
3.0	140/ 147	1MZ-FE	OEM Optional	06/98-06/01	PK20TR11	3253	1.1		K20TT	IK20TT	IK20TT			6
CAMRY SOLARA (00-02)														
2.2	101	5S-FE		02/00-11/02	PK20TR11	3253	1.1		K20TT	IK20TT	IK20TT			4
3.0	140/ 147	1MZ-FE		02/00-11/02	SK20R11	3297	1.1			IK20TT	IK20TT			6
CAMRY SOLARA (03-08)														
2.4	117	2AZ-FE		07/03-07/08	SK20R11	3297	1.1			IK20TT	IK20TT			4
3.0	137	1MZ-FE		07/03-07/08	SK20R11	3297	1.1			IK20TT	IK20TT			6
3.3	155/ 165	3MZ-FE		07/03-07/08	SK20R11	3297	1.1			IK20TT	IK20TT			6
CAMRY SOLARA (04-08)														
2.4	117	2AZ-FE		02/04-11/08	SK20R11	3297	1.1			IK20TT	IK20TT			4
3.0	137	1MZ-FE		02/04-11/08	SK20R11	3297	1.1			IK20TT	IK20TT			6
3.3	155/ 165	3MZ-FE		02/04-11/08	SK20R11	3297	1.1			IK20TT	IK20TT			6
CARIBE (84-03)														
1.3	48	2A		10/86-08/94	W16EXR-U	3031	0.8		W16TT	IW16TT	IW16TT			4
CARINA (73-83)														
1.6	63	2TB		10/75-03/78	W16EXR-U	3031	0.8		W16TT	IW16TT	IW16TT			4
1.6	55	2T		02/76-03/78	W16EX-U	3027	0.8		W16TT	IW16TT	IW16TT			4
1.6 (TA12)	58	2T		05/73-03/78	W16EXR-U	3031	0.8		W16TT	IW16TT	IW16TT			4
1.6 (TA4K)	54	2T		03/81-01/82	W16EX-U	3027	0.8		W16TT	IW16TT	IW16TT			4
1.6 (TA4K, TA60LG)	55	2T		04/78-09/83	W16EX-U	3027	0.8		W16TT	IW16TT	IW16TT			4
1.6 (TA4L, TA60L)	55	2T		01/78-09/83	W16EX-U	3027	0.8		W16TT	IW16TT	IW16TT			4
1.8	57/63	3T; 3T-C		01/78-09/83	W16EXR-U	3031	0.8		W16TT	IW16TT	IW16TT			4
1.8 D	48	1C		04/82-09/83	DG-223			7V						4
1.8 XE	62	3T		08/81-09/83	W16EXR-U	3031	0.8		W16TT	IW16TT	IW16TT			4
CARINA E (92-97)														
1.5 SG	77	5A-FE		04/92-09/97	K16R-U11	3120	1.1		K16TT	IK16TT	IK16TT			4
1.6	85	4A-FE		04/92-09/97	PK20R13	3226	1.3		K20TT	IK20TT	IK20TT			4
1.6 (AT190)	73/78	4A-FE		12/93-09/97	K20R-U	3122	0.8		K20TT	IK20TT	IK20TT			4
1.6 (AT190)	79	4A-FE		01/93-09/97	PQ20R	3117	1.1		Q20TT	IQ20TT	IQ20TT			4
1.6 (AT190)	73/85	4A-FE		12/93-09/97	Q16R-U	3129	0.8		Q16TT	IQ16TT	IQ16TT			4
1.6 16V	78	4A-FE		10/95-09/97	Q16R-U	3129	0.8		Q16TT	IQ16TT	IQ16TT			4
1.6 16V (AT190_)	85	4A-FE		12/94-09/97	K20R-U	3122	0.8		K20TT	IK20TT	IK20TT			4
1.6 GLI (AT190)	79	4A-FE		04/92-09/97	Q16R-U	3129	0.8		Q16TT	IQ16TT	IQ16TT			4
1.6 GLI (AT190_)	79	4A-FE		01/93-09/97	K16R-U11	3120	1.1		K16TT	IK16TT	IK16TT			4
1.6 i (AT190_)	73	4A-FE		02/95-09/97	PK20R13	3226	1.3		K20TT	IK20TT	IK20TT			4
1.8	85	7A-FE		04/92-09/97	PK20R13	3226	1.3		K20TT	IK20TT	IK20TT			4
1.8 (AT191)	79	7A-FE		01/95-09/97	PK20R13	3226	1.3		K20TT	IK20TT	IK20TT			4
1.8 GL	92	7A-FE		10/94-09/97	PK20R13	3226	1.3		K20TT	IK20TT	IK20TT			4
1.8 i (AT191_)	79	7A-FE		02/95-09/97	PK20R13	3226	1.3		K20TT	IK20TT	IK20TT			4
1.8 i 16V (AT191)	79	7A-FE		01/95-09/97	PK20R13	3226	1.3		K20TT	IK20TT	IK20TT			4
2.0 (ST191)	98	3S-FE		01/93-09/97	K20R-U11	3139	1.1		K20TT	IK20TT	IK20TT			4
2.0 D (CT190)	54	2C		04/92-01/96	DG-214			11V						4
2.0 D (CT190)	54	2C		04/92-01/96	DG-216			11V						4
2.0 D (CT190_)	54	2C		01/93-01/96	DG-214			11V						4
2.0 D (CT190_)	54	2C		01/93-01/96	DG-216			11V						4
2.0 GLI (ST191)	98	3S-FE		04/92-09/97	K20R-U11	3139	1.1		K20TT	IK20TT	IK20TT			4
2.0 GLI (ST191_)	98	3S-FE		01/93-09/97	K20R-U11	3139	1.1		K20TT	IK20TT	IK20TT			4
2.0 GTi (ST191)	116	3S-GE		04/92-02/94	PK20R8	3127	0.8			IK20TT	IK20TT			4
2.0 GTi (ST191_)	116	3S-GE		04/92-02/94	PK20R8	3127	0.8			IK20TT	IK20TT			4
2.0 GTi 16V (ST191_)	129	3S-GE		03/94-09/97	PK20R8	3127	0.8			IK20TT	IK20TT			4
2.0 i (ST191)	93	3S-FE		12/92-09/97	K20R-U11	3139	1.1		K20TT	IK20TT	IK20TT			4
2.0 i (ST191_)	93	3S-FE		05/95-09/97	K20R-U11	3139	1.1		K20TT	IK20TT	IK20TT			4
2.0 TD (CT190)	61	2C-T		01/96-09/97	DG-214			11V						4
2.0 TD (CT190_)	61	2C-T		01/96-09/97	DG-214			11V						4
CARINA II (83-92)														
1.6 (AT151)	55/ 62/ 63	4A-LC		10/83-11/87	W16EXR-U	3031	0.8		W16TT	IW16TT	IW16TT			4
1.6 (AT171)	72/75	4A-FE		12/87-03/92	Q16R-U	3129	0.8		Q16TT	IQ16TT	IQ16TT			4
1.6 (AT171)	66	4A-F		12/87-08/90	Q16R-U11	3006	1.1		Q16TT	IQ16TT	IQ16TT			4
1.6 (AT171)	66	4A-F		12/87-12/89	QJ16AR-U	3235	0.8							4









Spark & Glow Plugs

Application Tables

	KW										QTY
TOYOTA <i>continued</i>											
CARINA II (83-92) <i>continued</i>											
1.6 (AT171)	72/75	4A-FE	LEAN BURN	12/87-03/92	IQ16	5301	1.1	-	IQ16TT	IQ16TT	4
1.6 4WD	66/77/88	4A-FE		12/87-03/92	Q16R-U	3129	0.8	Q16TT	IQ16TT	IQ16TT	4
1.6 4WD	66/77/88	4A-FE	LEAN BURN	12/87-03/92	IQ16	5301	1.1	-	IQ16TT	IQ16TT	4
1.6 GX 4WD	88	4A-FE		12/87-03/92	Q16R-U	3129	0.8	Q16TT	IQ16TT	IQ16TT	4
1.6 GX 4WD	88	4A-FE	LEAN BURN	12/87-03/92	IQ16	5301	1.1	-	IQ16TT	IQ16TT	4
1.8 GLI (ST150)	74	1S-EL		05/85-11/87	W16EXR-U	3031	0.8	W16TT	IW16TT	IW16TT	4
2.0	89	3S-FE		12/87-11/89	Q20R-U11	3009	1.1	Q20TT	IQ20TT	IQ20TT	4
2.0 D	50/54	2C-L		02/84-06/92	DG-214		11V				4
2.0 D	50	2C-L		02/84-12/86	DG-232		10.5V				4
2.0 D	50	2C-L	QuickGlow System	02/84-05/88	DG-223		7V				4
2.0 D (CT150)	51	2C-L		12/85-11/87	DG-214		11V				4
2.0 D (CT150)	51	2C-L	QuickGlow System	12/85-11/87	DG-223		7V				4
2.0 D (CT170)	54	2C-L		12/87-01/92	DG-214		11V				4
2.0 D (CT170)	54	2C-L		12/87-01/92	DG-216		11V				4
2.0 GLi	94	3S-FE		12/87-03/92	Q20R-U11	3009	1.1	Q20TT	IQ20TT	IQ20TT	4
2.0 GLI (ST171)	89	3S-FE		12/87-03/92	Q20R-U11	3009	1.1	Q20TT	IQ20TT	IQ20TT	4
CELICA (73-78)											
1.6 GT (TA2, TA22)	79	2T-G		12/74-03/78	W20EXR-U	3066	0.8	W20TT	IW20TT	IW20TT	4
1.6 LT (TA2)	55	2T		02/76-03/78	W16EXR-U	3031	0.8	W16TT	IW16TT	IW16TT	4
1.6 ST (TA2, TA22)	63	2TB		10/75-03/78	W16EXR-U	3031	0.8	W16TT	IW16TT	IW16TT	4
1.6 ST (TA2, TA22)	63	2TB		05/73-10/75	W16EX-U	3027	0.8	W16TT	IW16TT	IW16TT	4
2.0	63	18R		10/75-07/77	W16EXR-U	3031	0.8	W16TT	IW16TT	IW16TT	4
CELICA (77-85)											
1.6	91	4A-GE		12/83-12/85	PQ16R	3005	1.1	Q16TT	IQ16TT	IQ16TT	4
1.6	91	4A-GE		08/83-07/85	Q20R-U11	3009	1.1	Q20TT	IQ20TT	IQ20TT	4
1.6 GT (TA4C)	80/81	2T-G		04/78-07/81	W20EXR-U	3066	0.8	W20TT	IW20TT	IW20TT	4
1.6 LT (TA4C)	55	2TB		02/79-07/81	W16EXR-U	3031	0.8	W16TT	IW16TT	IW16TT	4
1.6 ST (TA4C, TA60)	63	2TB		08/77-07/81	W16EXR-U	3031	0.8	W16TT	IW16TT	IW16TT	4
1.6 ST (TA60)	63/66	2TB		08/77-07/81	W16EXR-U	3031	0.8	W16TT	IW16TT	IW16TT	4
2.0	77/88	18R-G; 21R-U		01/82-12/85	W20EXR-U	3066	0.8	W20TT	IW20TT	IW20TT	4
2.0 GT (RA63)	90	18R-G		08/77-07/81	W20EXR-U	3066	0.8	W20TT	IW20TT	IW20TT	4
2.0 XT (RA40)	65/66	18R		02/79-07/81	W16EXR-U	3031	0.8	W16TT	IW16TT	IW16TT	4
2.0 XT (RA61)	77	21R-C		02/82-08/85	W16EXR-U	3031	0.8	W16TT	IW16TT	IW16TT	4
CELICA (85-89)											
1.6	63	4A-L		04/86-08/89	W16EXR-U	3031	0.8	W16TT	IW16TT	IW16TT	4
1.6 GT	85	4A-GELC		08/87-08/89	PQ16R	3005	1.1	Q16TT	IQ16TT	IQ16TT	4
1.6 GT 16V	91	4A-GEL		09/85-08/89	Q20R-U11	3009	1.1	Q20TT	IQ20TT	IQ20TT	4
2.0	110	3S-GEL		01/87-08/89	PQ16R	3005	1.1	Q16TT	IQ16TT	IQ16TT	4
2.0	103	3S-GEL; 3S-GELC		08/87-08/89	Q20R-U11	3009	1.1	Q20TT	IQ20TT	IQ20TT	4
2.0 GT	103/110	3S-GELC		08/85-08/89	Q20R-U11	3009	1.1	Q20TT	IQ20TT	IQ20TT	4
2.0 GT (ST162)	103/110	3S-GELC		08/85-08/89	Q20R-U11	3009	1.1	Q20TT	IQ20TT	IQ20TT	4
2.0 Turbo 4WD	136	3S-GTE		03/88-08/89	PQ16R8	3123	0.8	Q16TT	IQ16TT	IQ16TT	4
CELICA (89-93)											
1.6 STi (AT180)	77	4A-FE		10/89-11/93	Q16R-U	3129	0.8	Q16TT	IQ16TT	IQ16TT	4
2.0 GTi (ST182)	115	3S-GE		10/89-11/93	PK20R8	3127	0.8	-	IK20TT	IK20TT	4
2.0 Turbo 4WD (ST185)	150/153	3S-GTE		10/89-11/93	PK20R8	3127	0.8	-	IK20TT	IK20TT	4
2.2	100	5S-FE		10/89-10/93	PK20TR11	3253	1.1	K20TT	IK20TT	IK20TT	4
CELICA (93-99)											
1.8 i 16V (AT200/ST)	85	7A-FE		11/93-11/99	K20R-U	3122	0.8	K20TT	IK20TT	IK20TT	4
2.0 GTi	129	3S-GE		08/94-08/99	K20R-U	3122	0.8	K20TT	IK20TT	IK20TT	4
2.0 i 16V	125	3S-GE		11/93-11/99	PK20R8	3127	0.8	-	IK20TT	IK20TT	4
2.0 i 16V (ST202/GT)	129	3S-GE		11/93-11/99	PK20R8	3127	0.8	-	IK20TT	IK20TT	4
2.0 i Turbo 4WD (ST205)	178	3S-GTE		02/94-11/99	PK20R8	3127	0.8	-	IK20TT	IK20TT	4
2.2 GT	100	5S-FE		11/93-08/99	PK20TR11	3253	1.1	K20TT	IK20TT	IK20TT	4
CELICA (99-05)											
1.8 16V TS (ZZT231_)	141	2ZZ-GE	OEM Optional	08/99-09/05	SK20R11	3297	1.1	-	IK20TT	IK20TT	4
1.8 16V VT-i (ZZT230_)	105	1ZZ-FE		08/99-07/05	K16R-U11	3120	1.1	K16TT	IK16TT	IK16TT	4
CELICA Supra (81-85)											
2.8 i	125	5M-GE		08/81-12/85	W20EXR-U	3066	0.8	W20TT	IW20TT	IW20TT	6
CENTURY (97-)											
5.0	206	1GZ-FE		04/97-	SK16R-P11	3353	1.1	-	IK16TT	IK16TT	12







Spark & Glow Plugs

Application Tables

	KW					Standard 			Twin Tip 			QTY	
TOYOTA continued													
CHASER (96-01)													
2.2	96	5S-FE		10/96-05/01	PK20TR11	3253	1.1		K20TT	IK20TT	IK20TT		4
COASTER (77-82)													
2.4	72	22R		08/77-04/82	W16EXR-U	3031	0.8		W16TT	IW16TT	IW16TT		4
COASTER (82-93)													
2.4	72	22R		05/82-09/89	W16EXR-U	3031	0.8		W16TT	IW16TT	IW16TT		4
COASTER (93-)													
4.1 LPG	85	1BZ-FPE	LPG / GPL	11/03-	SK20R5-G	3415	0.5		-	-	SK20R5-G		4
COROLLA (E7) (79-87)													
1.3 (KE70)	44	4K-C		12/79-01/82	W14EX-U	3011	0.8		-	IW16TT	IW16TT		4
1.3 (KE70)	44/48	4K		09/79-08/87	W16EXR-U	3031	0.8		W16TT	IW16TT	IW16TT		4
1.6 (TE71)	63	2TB		09/79-05/83	W16EXR-U	3031	0.8		W16TT	IW16TT	IW16TT		4
1.6 (TE71)	54/55	2T		09/79-09/83	W16EX-U	3027	0.8		W16TT	IW16TT	IW16TT		4
1.6 GT	81	2T-G		05/80-09/83	W20EXR-U	3066	0.8		W20TT	IW20TT	IW20TT		4
1.6 GT (TE71)	81	2T-G		05/80-09/83	W20EXR-U	3066	0.8		W20TT	IW20TT	IW20TT		4
1.8 (TE72)	57/63	3T; 3T-C		09/79-09/83	W16EXR-U	3031	0.8		W16TT	IW16TT	IW16TT		4
1.8 D (CE70)	43/ 44/ 48	1C		01/83-09/83	DG-223		7V						4
COROLLA (E8) (83-89)													
1.3	60	2E		08/83-04/87	W16EXR-U11	3032	1.1		W16TT	IW16TT	IW16TT		4
1.3 (AE80)	48/51	2A; 2A-L		06/83-05/89	W16EXR-U	3031	0.8		W16TT	IW16TT	IW16TT		4
1.3 (AE80/EE80)	55	2E-L		10/84-08/87	W16EXR-U11	3032	1.1		W16TT	IW16TT	IW16TT		4
1.3 (EE80)	55	2E-L		01/85-08/87	W16EXR-U11	3032	1.1		W16TT	IW16TT	IW16TT		4
1.6	54/63	4A-LC		07/85-05/88	W16EXR-U	3031	0.8		W16TT	IW16TT	IW16TT		4
1.6 (AE82)	53/ 54/ 58/ 62	4A-LC		06/83-08/87	W16EXR-U	3031	0.8		W16TT	IW16TT	IW16TT		4
1.6 16V	85	4A-GEC		12/85-04/87	PQ16R	3005	1.1		Q16TT	IQ16TT	IQ16TT		4
1.6 GT 16V (AE86)	91	4A-GE		08/83-07/87	PQ16R	3005	1.1		Q16TT	IQ16TT	IQ16TT		4
1.6 SR 16V	57	4A-C		05/83-04/87	W16EXR-U	3031	0.8		W16TT	IW16TT	IW16TT		4
1.8 D	43	1C		05/87-05/88	DG-214		11V						4
1.8 D	43/47	1C; 1C-L		06/83-04/87	DG-223		7V						4
1.8 D	43	1C		06/83-12/83	DG-232		10.5V						4
1.8 D (CE80)	47	1C-L		06/83-04/87	DG-223		7V						4
COROLLA (E9) (87-93)													
1.3	60	2E		05/87-04/92	W16EXR-U11	3032	1.1		W16TT	IW16TT	IW16TT		4
1.3 (EE90)	55	2E		08/87-06/92	W16EXR-U11	3032	1.1		W16TT	IW16TT	IW16TT		4
1.3 i (EE90)	55	2E-E		08/87-12/92	W16EXR-U	3031	0.8		W16TT	IW16TT	IW16TT		4
1.3 i (EE90)	55	2E		08/87-12/92	W16EXR-U11	3032	1.1		W16TT	IW16TT	IW16TT		4
1.5	92	5A-FE		11/89-04/92	K16R-U11	3120	1.1		K16TT	IK16TT	IK16TT		4
1.6 (AE92)	77	4A-FE		08/89-04/92	Q16R-U	3129	0.8		Q16TT	IQ16TT	IQ16TT		4
1.6 (AE92)	66	4A-F		08/87-12/89	Q16R-U11	3006	1.1		Q16TT	IQ16TT	IQ16TT		4
1.6 (AE92)	66/70	4A-F		08/87-04/92	QJ16AR-U	3235	0.8		-	-	-		4
1.6 GTi	92	4A-GE		07/87-06/93	PQ16R	3005	1.1		Q16TT	IQ16TT	IQ16TT		4
1.6 GTi (AE92, AE93)	85	4A-GE		08/87-04/92	PQ16R	3005	1.1		Q16TT	IQ16TT	IQ16TT		4
1.6 i	77	4A-FE		11/89-06/93	Q16R-U	3129	0.8		Q16TT	IQ16TT	IQ16TT		4
1.6 i (AE92)	77	4A-FE		08/89-04/92	Q16R-U	3129	0.8		Q16TT	IQ16TT	IQ16TT		4
1.6 i 4WD	77	4A-FE		10/87-08/90	Q16R-U	3129	0.8		Q16TT	IQ16TT	IQ16TT		4
1.6 XLI	77	4A-FE		11/89-06/92	PQ20R	3117	1.1		Q20TT	IQ20TT	IQ20TT		4
1.6 XLI 4WD (AE95)	77	4A-FE		08/88-06/92	K16R-U11	3120	1.1		K16TT	IK16TT	IK16TT		4
1.8 D	47/49	1C		07/87-06/93	DG-214		11V						4
1.8 D	47	1C		07/87-04/92	DG-216		11V						4
1.8 D (CE90)	47/49	1C		08/87-06/92	DG-214		11V						4
1.8 D (CE90)	47/49	1C		12/87-06/92	DG-216		11V						4
COROLLA (E10) (92-99)													
1.3 12V (EE100_)	53	2E		07/92-04/97	W16EXR-U11	3032	1.1		W16TT	IW16TT	IW16TT		4
1.3 XLI (EE101_)	55/65	4E-FE		07/92-04/97	K16TR11	3194	1.1		K16TT	IK16TT	IK16TT		4
1.3 XLI 16V (EE101)	65	4E-FE		07/92-09/95	K16TR11	3194	1.1		K16TT	IK16TT	IK16TT		4
1.3 XLI 16V (EE101_)	65	4E-FE		07/92-09/95	K16TR11	3194	1.1		K16TT	IK16TT	IK16TT		4
1.6 GLI (AE101_)	84	4A-FE		07/92-04/97	K20R-U	3122	0.8		K20TT	IK20TT	IK20TT		4
1.6 Si (AE101_)	84	4A-FE		07/92-04/97	K20R-U	3122	0.8		K20TT	IK20TT	IK20TT		4
1.6 Si (AE101_)	84	4A-FE		07/92-04/97	PQ20R	3117	1.1		Q20TT	IQ20TT	IQ20TT		4
1.6 Si (AE101_)	84	4A-FE		09/95-04/97	Q16R-U	3129	0.8		Q16TT	IQ16TT	IQ16TT		4
1.8	81	7A-FE		09/92-04/97	K20R-U	3122	0.8		K20TT	IK20TT	IK20TT		4
1.8 16V 4WD (AE103_)	81	7A-FE		09/95-04/97	K20R-U	3122	0.8		K20TT	IK20TT	IK20TT		4
1.8 GT (AE102_)	86	7A-FE		11/92-05/95	K20R-U	3122	0.8		K20TT	IK20TT	IK20TT		4
1.8 GTi 4WD	81/92	7A-FE		05/92-07/95	K20R-U	3122	0.8		K20TT	IK20TT	IK20TT		4
1.8 i	85	7A-FE		11/92-09/94	K20R-U	3122	0.8		K20TT	IK20TT	IK20TT		4



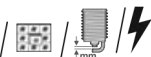



Spark & Glow Plugs

Application Tables

	KW					Standard		Twin Tip		QTY	
TOYOTA <i>continued</i>											
COROLLA (E10) (92-99) <i>continued</i>											
1.8 XL	88	7A-FE		09/92-11/93	K20R-U	3122	0.8	K20TT	IK20TT	IK20TT	4
1.8 XL 4WD	88	7A-FE		09/92-11/93	K20R-U	3122	0.8	K20TT	IK20TT	IK20TT	4
2.0 D (CE100_)	53	2C		07/92-04/97	DG-214		11V				4
2.0 D (CE100_)	53	2C		07/92-07/95	DG-216		11V				4
COROLLA (E11) (97-02)											
1.3	55	2E		05/97-10/01	W16EXR-U11	3032	1.1	W16TT	IW16TT	IW16TT	4
1.4 (EE111_)	63	4E-FE		04/97-02/00	K16TR11	3194	1.1	K16TT	IK16TT	IK16TT	4
1.4 (ZZE111_)	71	4ZZ-FE		02/00-01/02	K16R-U11	3120	1.1	K16TT	IK16TT	IK16TT	4
1.4 16V (ZZE111_)	71	4ZZ-FE		02/00-11/01	K16R-U11	3120	1.1	K16TT	IK16TT	IK16TT	4
1.5	78	1NZ-FE		09/99-10/01	K16R-U11	3120	1.1	K16TT	IK16TT	IK16TT	4
1.6 (AE111_)	81	4A-FE		04/97-02/00	K20R-U	3122	0.8	K20TT	IK20TT	IK20TT	4
1.6 (ZZE112_)	81	3ZZ-FE		02/00-01/02	K16R-U11	3120	1.1	K16TT	IK16TT	IK16TT	4
1.6 (ZZE112_)	81	3ZZ-FE	UPP	02/00-01/02	K16R-U11	3120	1.1	K16TT	IK16TT	IK16TT	4
1.6 16V (ZZE112_)	81	3ZZ-FE		02/00-11/01	K16R-U11	3120	1.1	K16TT	IK16TT	IK16TT	4
1.6 Aut. (AE111_)	79	4A-FE		04/97-02/00	K20R-U	3122	0.8	K20TT	IK20TT	IK20TT	4
1.8	81/85	7A-FE		10/97-12/01	K20R-U	3122	0.8	K20TT	IK20TT	IK20TT	4
1.8 (AE112)	85	7A-FE		09/98-11/01	K20R-U	3122	0.8	K20TT	IK20TT	IK20TT	4
1.8 4WD (AE115_)	81	7A-FE		04/97-10/01	K20R-U	3122	0.8	K20TT	IK20TT	IK20TT	4
1.9 D (WZE110_)	51	1WZ		02/00-01/02	DG-003		11V				4
2.0 D (CE110)	53	2C-E		04/97-02/00	DG-214		11V				4
2.0 D (CE110_)	53	2C-E		04/97-02/00	DG-214		11V				4
2.0 D-4D	66	1CD-FTV		09/00-11/01	DG-245		11V				4
COROLLA (E12) (01-07)											
1.3	64	2NZ-FE		11/01-05/04	K16R-U11	3120	1.1	K16TT	IK16TT	IK16TT	4
1.4 D	66	1ND-TV		07/04-02/07	DG-240		11V				4
1.4 D-4D	66	1ND-TV		07/04-07/07	DG-240		11V				4
1.4 D4-D	66	1ND-TV		07/04-02/07	DG-240		11V				4
1.4 VVT-i	71	4ZZ-FE		01/02-07/07	K16R-U11	3120	1.1	K16TT	IK16TT	IK16TT	4
1.5	80/81	1NZ-FE		11/01-07/07	K16R-U11	3120	1.1	K16TT	IK16TT	IK16TT	4
1.5 G 4WD	80	1NZ-FE		11/01-05/04	K16R-U11	3120	1.1	K16TT	IK16TT	IK16TT	4
1.6	91	1ZR-FE		11/06-07/07	SC20HR11	3444	1.1	-	IXEH22TT	IXEH22TT	4
1.6 VVT-i	81	3ZZ-FE		01/02-07/07	K16R-U11	3120	1.1	K16TT	IK16TT	IK16TT	4
1.8	92/ 96/ 100	1ZZ-FE		03/01-02/07	K16R-U11	3120	1.1	K16TT	IK16TT	IK16TT	4
1.8 4WD	100	1ZZ-FE		12/01-02/07	K16R-U11	3120	1.1	K16TT	IK16TT	IK16TT	4
1.8 VVTi	100	1ZZ-FE		06/04-02/07	K16R-U11	3120	1.1	K16TT	IK16TT	IK16TT	4
1.8 VTL-i TS	160/ 165	2ZZ-GE		02/05-02/07	SK20R11	3297	1.1	-	IK20TT	IK20TT	4
1.8 VTL-i TS	141	2ZZ-GE	OEM Optional	01/02-02/07	SK20R11	3297	1.1	-	IK20TT	IK20TT	4
2.0 D-4D	66	1CD-FTV		08/02-07/07	DG-102		11V				4
2.0 D-4D	66/ 81/ 85	1CD-FTV		01/02-07/07	DG-245		11V				4
COROLLA (E14, E15) (06-)											
1.33	74	1NR-FE		12/08-	SC20HR11	3444	1.1	-	IXEH22TT	IXEH22TT	4
1.4 D-4D	66	1ND-TV		01/07-12/08	DG-240		11V				4
1.4 VVT-i	71	4ZZ-FE		01/07-	K16R-U11	3120	1.1	K16TT	IK16TT	IK16TT	4
1.5	81	1NZ-FE		09/06-	VFKH16	5654	1.1	-	IKH16TT	IKH16TT	4
1.5 4WD	77	1NZ-FE		09/06-	VFKH16	5654	1.1	-	IKH16TT	IKH16TT	4
1.6	97	1ZR-FAE; 1ZR-FE		01/09-	SC20HR11	3444	1.1	-	IXEH22TT	IXEH22TT	4
1.6 Dual VVTi	91	1ZR-FE		01/07-	SC20HR11	3444	1.1	-	IXEH22TT	IXEH22TT	4
1.8	106/ 108	2ZR-FAE		01/09-	SC20HR11	3444	1.1	-	IXEH22TT	IXEH22TT	4
1.8 4WD	98	2ZR-FAE		09/06-	SC20HR11	3444	1.1	-	IXEH22TT	IXEH22TT	4
1.8 VVTi	103	2ZR-FE		08/10-	SC20HR11	3444	1.1	-	IXEH22TT	IXEH22TT	4
1.8 VTL-i (ZZE152)	100	2ZR-FE		05/07-	SC20HR11	3444	1.1	-	IXEH22TT	IXEH22TT	4
2.0 D-4D	93	1AD-FTV		01/07-	DG-600		11V				4
2.2 D-4D	130	2AD-FHV		11/06-	DG-600		11V				4
COROLLA (E16) (12-)											
1.3	70	1NR-FE		11/13-	SC16HR11	3499	1.1	-	IXEH20TT	IXEH20TT	4
1.3	70	1NR-FE		05/12-11/13	SC20HR11	3444	1.1	-	IXEH22TT	IXEH22TT	4
1.5	80	1NZ-FE		05/12-	VFKH16	5654	1.1	-	IKH16TT	IKH16TT	4
1.5 4WD	76	1NZ-FE		05/12-	VFKH16	5654	1.1	-	IKH16TT	IKH16TT	4
1.8	103	2ZR-FAE		05/12-	SC20HR11	3444	1.1	-	IXEH22TT	IXEH22TT	4
COROLLA (E18) (13-)											
1.3	73	1NR-FE		11/13-	SC16HR11	3499	1.1	-	IXEH20TT	IXEH20TT	4
1.3	73	1NR-FE		06/13-11/13	SC20HR11	3444	1.1	-	IXEH22TT	IXEH22TT	4
1.6	97	1ZR-FAE		06/13-	SC20HR11	3444	1.1	-	IXEH22TT	IXEH22TT	4







Spark & Glow Plugs

Application Tables

	KW					Standard			Twin Tip				QTY	
TOYOTA <i>continued</i>														
COROLLA (E18) (13-) <i>continued</i>														
1.8 VVTi	103	2ZR-FBE; 2ZR-FE		06/13-	SC20HR11	3444	1.1	-		IXEH22TT	IXEH22TT		4	
COROLLA (KE) (72-80)														
1.2	40	3K-B; 3K-C; 3K-H		09/76-01/80	W16EXR-U	3031	0.8	W16TT	IW16TT	IW16TT			4	
1.2 (KE20, KE25)	43	3K-B; 3K-C; 3K-H		10/72-06/77	W16EXR-U	3031	0.8	W16TT	IW16TT	IW16TT			4	
1.2 (KE20, KE25, KE30)	40	3K-B; 3K-C; 3K-H		08/74-12/80	W16EXR-U	3031	0.8	W16TT	IW16TT	IW16TT			4	
1.2 (KE35)	40	3K-B; 3K-C; 3K-H		07/75-01/80	W16EXR-U	3031	0.8	W16TT	IW16TT	IW16TT			4	
1.2 (KE36)	40	3K; 3K-B; 3K-H		07/75-01/80	W16EXR-U	3031	0.8	W16TT	IW16TT	IW16TT			4	
1.3 (KE55)	44	4K-C		08/81-01/80	W14EXR-U	3013	0.8	-	IW16TT	IW16TT			4	
1.3 (KE55)	44	4K-C		11/78-01/80	W16EXR-U	3031	0.8	W16TT	IW16TT	IW16TT			4	
1.6	54/62	2T; 2TB		09/76-01/80	W16EXR-U	3031	0.8	W16TT	IW16TT	IW16TT			4	
COROLLA FX (84-88)														
1.3	55/60	2E-L		10/84-08/87	W16EXR-U11	3032	1.1	W16TT	IW16TT	IW16TT			4	
1.6	54	4A-LC		01/87-09/87	W16EXR-U	3031	0.8	W16TT	IW16TT	IW16TT			4	
1.6 GT 16V	89	4A-GEL		08/85-08/87	PQ16R	3005	1.1	Q16TT	IQ16TT	IQ16TT			4	
1.8 D	43	1C		01/85-05/87	DG-214		11V						4	
1.8 D	43/47	1C; 1C-L		01/85-08/87	DG-223		7V						4	
COROLLA Rumion (07-)														
1.5	81	1NZ-FE		09/07-	VFKH16	5654	1.1	-		IKH16TT	IKH16TT		4	
1.8	106	2ZR-FAE		09/07-	SC20HR11	3444	1.1	-		IXEH22TT	IXEH22TT		4	
1.8 4WD	100	2ZR-FAE		09/07-	SC20HR11	3444	1.1	-		IXEH22TT	IXEH22TT		4	
COROLLA Verso (01-09)														
1.4 VVT-i	71	4ZZ-FE		01/02-05/04	K16R-U11	3120	1.1	K16TT	IK16TT	IK16TT			4	
1.5	80	1NZ-FE		03/04-03/09	VFKH16	5654	1.1	-		IKH16TT	IKH16TT		4	
1.6	81	3ZZ-FE		04/04-03/09	K16R-U11	3120	1.1	K16TT	IK16TT	IK16TT			4	
1.6 VVT-i	81	3ZZ-FE		01/02-05/04	K16R-U11	3120	1.1	K16TT	IK16TT	IK16TT			4	
1.8	95	1ZZ-FE		04/04-03/09	K16R-U11	3120	1.1	K16TT	IK16TT	IK16TT			4	
1.8 VVT-i	99	1ZZ-FE		01/02-05/04	K16R-U11	3120	1.1	K16TT	IK16TT	IK16TT			4	
2.0 D-4D	66/85	1CD-FTV		09/01-05/04	DG-245		11V						4	
2.2 D-4D	100/130	2AD-FHV; 2AD-FTV		10/05-03/09	DG-600		11V						4	
CORONA (70-87)														
1.8	63	3T		06/79-07/81	W16EXR-U	3031	0.8	W16TT	IW16TT	IW16TT			4	
1.8 (TT1)	63	3T		10/79-01/81	W16EXR-U	3031	0.8	W16TT	IW16TT	IW16TT			4	
2.0	65	18R		09/75-05/79	W16EXR-U	3031	0.8	W16TT	IW16TT	IW16TT			4	
2.0 (RT104)	65	18R		01/76-05/79	W16EXR-U	3031	0.8	W16TT	IW16TT	IW16TT			4	
2.0 Mark II (RX12)	65	18R		12/75-10/77	W16EXR-U	3031	0.8	W16TT	IW16TT	IW16TT			4	
2.0 Mark II (RX22)	65	18R		12/75-10/77	W16EXR-U	3031	0.8	W16TT	IW16TT	IW16TT			4	
2.4	87	22RE		11/84-04/87	W16EXR-U	3031	0.8	W16TT	IW16TT	IW16TT			4	
CORONA (87-92)														
1.5	85/92	5A-F; 5A-FE		11/87-08/89	K16R-U11	3120	1.1	K16TT	IK16TT	IK16TT			4	
CORSA (94-99)														
1.3	65	4E-FE		11/94-09/99	K16TR11	3194	1.1	K16TT	IK16TT	IK16TT			4	
CRESSIDA (77-81)														
2.0	65	18R		12/77-03/81	W16EXR-U	3031	0.8	W16TT	IW16TT	IW16TT			4	
2.0 (RX30)	66	18R		07/77-07/81	W16EXR-U	3031	0.8	W16TT	IW16TT	IW16TT			4	
2.0 (RX35)	66	18R		12/77-03/81	W16EXR-U	3031	0.8	W16TT	IW16TT	IW16TT			4	
CRESSIDA (80-93)														
2.0	77	21R		02/81-03/85	W16EXR-U	3031	0.8	W16TT	IW16TT	IW16TT			4	
2.0 (RX60)	77	21R		05/81-03/85	W16EXR-U	3031	0.8	W16TT	IW16TT	IW16TT			4	
2.0 GLI	80	1G-E		11/82-12/84	W20EXR-U	3066	0.8	W20TT	IW20TT	IW20TT			6	
2.2 D	49	L		06/81-08/82	DG-211		11V						4	
2.2 D	49	L		08/82-03/85	DG-215		7V						4	
2.2 D	49	L		06/81-07/84	DG-221		11V						4	
2.2 D (LX60)	49	L		09/80-08/82	DG-211		11V						4	
2.2 D (LX60)	49	L		08/82-07/84	DG-215		7V						4	
2.2 D (LX60)	49	L		09/80-07/84	DG-221		11V						4	
2.4 TD	66	2L-T		05/85-08/86	DG-213		6V						4	
2.8	106	5M-E		05/85-09/88	W14EXR-U	3013	0.8	-	IW16TT	IW16TT			6	
2.8	125	5M-GE		05/85-09/88	W16EXR-U	3031	0.8	W16TT	IW16TT	IW16TT			6	
CRESSIDA (92-96)														
2.0 S	100	1G-FE		10/92-02/93	K20R-U	3122	0.8	K20TT	IK20TT	IK20TT			6	
CRESTA (84-01)														
2.4	81	22R		06/87-08/88	W16EXR-U	3031	0.8	W16TT	IW16TT	IW16TT			4	
CROWN (80-85)														
2.2 D (LS110_)	53	L		04/80-07/83	DG-211		11V						4	
2.2 D (LS110_)	53	L		04/80-07/83	DG-221		11V						4	
2.8 i Super Saloon (S12)	125	5M-GE		02/84-03/85	W20EXR-U	3066	0.8	W20TT	IW20TT	IW20TT			6	











Spark & Glow Plugs

Application Tables

	KW					Standard			Twin Tip			QTY
TOYOTA <i>continued</i>												
CROWN (80-85) <i>continued</i>												
2.8 SI (MS112)	107	5M-E		04/80-07/83	W20EXR-U	3066	0.8		W20TT	IW20TT	IW20TT	6
CROWN (91-99)												
2.4 D	67	2L-TE		08/94-08/99	DG-310		11V					4
CROWN (99-03)												
2.4 D	67	2L-TE		09/99-07/02	DG-310		11V					4
CROWN (03-08)												
2.5 Athlete	158	4GR-FSE		09/03-02/08	FK20HBR11	3473	1.1	-	IKBH20TT	IKBH20TT	IKBH20TT	6
3.0	188	3GR-FSE		09/03-02/08	FK20HBR11	3473	1.1	-	IKBH20TT	IKBH20TT	IKBH20TT	6
3.0	170	3GR-FE		05/05-02/08	FK20HR11	3426	1.1	-	IKH20TT	IKH20TT	IKH20TT	6
3.0	170	3GR-FE		09/04-05/05	SK20HR11	3421	1.1	-	IKH20TT	IKH20TT	IKH20TT	6
3.0 4WD	188	3GR-FSE		09/03-02/08	FK20HBR11	3473	1.1	-	IKBH20TT	IKBH20TT	IKBH20TT	6
CROWN (08-12)												
2.5 V6	149	4GR-FSE		02/08-11/12	FK20HBR11	3473	1.1	-	IKBH20TT	IKBH20TT	IKBH20TT	6
2.5 V6 4WD	149	4GR-FSE		02/08-11/12	FK20HBR11	3473	1.1	-	IKBH20TT	IKBH20TT	IKBH20TT	6
3.0	188	3GR-FSE		02/08-11/12	FK20HBR11	3473	1.1	-	IKBH20TT	IKBH20TT	IKBH20TT	6
3.0	167	3GR-FE		02/08-11/12	FK20HR11	3426	1.1	-	IKH20TT	IKH20TT	IKH20TT	6
3.0 4WD	188	3GR-FSE		02/08-11/12	FK20HBR11	3473	1.1	-	IKBH20TT	IKBH20TT	IKBH20TT	6
3.5 Hybrid	218	2GR-FSE		02/08-11/12	FK20HBR11	3473	1.1	-	IKBH20TT	IKBH20TT	IKBH20TT	6
3.5 V6	232	2GR-FSE		02/08-11/12	FK20HBR11	3473	1.1	-	IKBH20TT	IKBH20TT	IKBH20TT	6
4.3 V8 4WD	206	3UZ-FE		04/09-11/12	SK20R11	3297	1.1	-	IK20TT	IK20TT	IK20TT	8
4.6	255	1UR-FSE		04/09-11/12	FK20HBR11	3473	1.1	-	IKBH20TT	IKBH20TT	IKBH20TT	8
CROWN (12-)												
2.5	149	4GR-FSE		12/12-	FK20HBR11	3473	1.1	-	IKBH20TT	IKBH20TT	IKBH20TT	6
2.5 4WD	149	4GR-FSE		12/12-	FK20HBR11	3473	1.1	-	IKBH20TT	IKBH20TT	IKBH20TT	6
3.5 V6	232	2GR-FSE		12/12-	FK20HBR11	3473	1.1	-	IKBH20TT	IKBH20TT	IKBH20TT	6
CURREN (89-94)												
2.2	97	5S-FE		09/89-09/94	PK20TR11	3253	1.1		K20TT	IK20TT	IK20TT	4
CURREN (93-98)												
2.2	100	5S-FE		10/95-10/98	PK20TR11	3253	1.1		K20TT	IK20TT	IK20TT	4
DYNA 100 (85-95)												
1.8	58/61	2Y		08/85-04/95	W16EX-U	3027	0.8		W16TT	IW16TT	IW16TT	4
DYNA 150 (85-88)												
1.8	58	2Y		08/85-08/86	W16EX-U	3027	0.8		W16TT	IW16TT	IW16TT	4
2.4 D	54	2L		08/85-08/87	DG-215		7V					4
DYNA 150 (88-95)												
3.4 D	66	3B		09/88-06/95	DG-219		23V					4
3.4 D	66	3B		09/88-06/95	DG-232		10.5V					4
DYNA 150 (95-01)												
2.4 D	54	2L		08/96-07/01	DG-212		11V					4
2.8 D	61	3L		05/95-08/98	DG-211		11V					4
2.8 D	61	3L		05/95-08/98	DG-242		11V					4
3.0 D	65	5L		09/98-07/01	DG-242		11V					4
DYNA (77-87)												
2.0	79	3Y		09/84-08/87	W16EXR-U	3031	0.8		W16TT	IW16TT	IW16TT	4
2.4 D	55	2L		08/77-04/79	DG-215		7V					4
2.4 D	55	2L		08/85-08/87	DG-221		11V					4
4.0D				09/84-07/87	DG-241		6V					4
DYNA (87-01)												
2.4 D	61	2L		08/87-08/97	DG-211		11V					4
2.4 D	61	2L		08/96-07/01	DG-212		11V					4
DYNA (01-)												
2.0	98	1TR-FE		09/06-	IW16	5305	1.1	-	IW16TT	IW16TT	IW16TT	4
2.0 4WD	98	1TR-FE		09/06-	IW16	5305	1.1	-	IW16TT	IW16TT	IW16TT	4
2.0 LPG	85	1TR-FPE		09/06-11/07	IW16	5305	1.1	-	IW16TT	IW16TT	IW16TT	4
2.0 LPG 4WD	85	1TR-FPE		09/06-11/07	IW16	5305	1.1	-	IW16TT	IW16TT	IW16TT	4
2.5 D4d	65/75	2KDFTV		08/01-	DG-245		11V					4
2.7	109	2TR-FE		09/06-	SK20HR11	3421	1.1	-	IKH20TT	IKH20TT	IKH20TT	4
3.0 D4d	65	5L		08/01-	DG-242		11V					4
3.0 D4d	80/ 100/ 106	1KD-FTV		09/06-	DG-245		11V					4
3.0 D4d 4WD	106	1KD-FTV		09/06-	DG-245		11V					4
4.1 LPG	85	1BZ-FPE		05/11-	SK20R5-G	3415	0.5	-	-	-	SK20R5-G	4
ECHO (99-05)												
1.4 D4d	55	1ND-TV		01/00-03/03	DG-240		11V					4
1.5 VVTi	78	1NZ-FE		04/99-08/05	K16R-U11	3120	1.1		K16TT	IK16TT	IK16TT	4











Spark & Glow Plugs

Application Tables

	KW				Standard			Twin Tip			QTY
											
TOYOTA continued											
FJ CRUISER (07-)											
4.0 i V6	193/200/203	1GR-FE		07/07-	K20HR-U11	3381	1.1	KH20TT	IKH20TT	IKH20TT	6
4.0 VVTi	178	1GR-FE		01/11-	K20HR-U11	3381	1.1	KH20TT	IKH20TT	IKH20TT	6
4.0 VVTi 4WD	178	1GR-FE		07/07-	K20HR-U11	3381	1.1	KH20TT	IKH20TT	IKH20TT	6
GT 86 (12-)											
2.0 GT	147	FA20		03/12-	VXEBH27	5686	0.8	-	-	VXEBH27	4
HARRIER (98-03)											
2.2 4WD	103	5S-FE		03/98-01/03	PK20TR11	3253	1.1	K20TT	IK20TT	IK20TT	4
2.4	118	2AZ-FE		06/00-01/03	K20R-U11	3139	1.1	K20TT	IK20TT	IK20TT	4
2.4	118	2AZ-FE	LEAN BURN	06/00-01/03	SK20R11	3297	1.1	-	IK20TT	IK20TT	4
2.4 4WD	118	2AZ-FE		06/00-01/03	K20R-U11	3139	1.1	K20TT	IK20TT	IK20TT	4
2.4 4WD	118	2AZ-FE	LEAN BURN	06/00-01/03	SK20R11	3297	1.1	-	IK20TT	IK20TT	4
3.0 4WD	164	1MZ-FE		03/98-01/03	SK20R11	3297	1.1	-	IK20TT	IK20TT	6
HARRIER (03-)											
2.4 VVTi	118	2AZ-FE		10/03-	SK20R11	3297	1.1	-	IK20TT	IK20TT	4
3.0 VVTi 4WD	150	1MZ-FE		10/03-12/08	SK20R11	3297	1.1	-	IK20TT	IK20TT	6
3.3 Hybrid	155	3MZ-FE		04/05-12/08	SK20R11	3297	1.1	-	IK20TT	IK20TT	6
3.3 VVTi 4WD	171	3MZ-FE		10/03-12/08	SK20R11	3297	1.1	-	IK20TT	IK20TT	6
3.5 VVTi 4WD	206	2GR-FE		04/05-12/08	FK20HR11	3426	1.1	-	IKH20TT	IKH20TT	6
HEAVY DUTY TRUCK (69-01)											
		2D		03/69-11/01	DG-231		21.5V				6
		2D	OE: 19850-76020	03/69-11/01	DG-228		19V				6
HIACE I (77-85)											
1.6	49	12R		01/79-11/82	W16EX-U	3027	0.8	W16TT	IW16TT	IW16TT	4
1.6 (RH20-30)	49	12R		02/77-03/83	W16EX-U	3027	0.8	W16TT	IW16TT	IW16TT	4
2.0 (RH25-32)	65	18R		07/77-03/83	W16EX-U	3027	0.8	W16TT	IW16TT	IW16TT	4
2.2 D	49	L		01/80-12/80	DG-221		11V				4
2.2 D (LH20-30)	46	L		09/79-11/82	DG-221		11V				4
2.2 D (LH20-30)	46	L	OE: 1985054010	01/79-03/83	DG-211		11V				4
2.2 D (LH20-30)	46	L	QuickGlow System.SGS	11/82-03/83	DG-215		7V				4
HIACE II (83-89)											
1.8	58	2Y		03/83-11/89	W16EXR-U	3031	0.8	W16TT	IW16TT	IW16TT	4
1.8 (H5G)	58	2Y		03/83-11/89	W16EX-U	3027	0.8	W16TT	IW16TT	IW16TT	4
2.0	65	3Y		01/84-11/89	W16EX-U	3027	0.8	W16TT	IW16TT	IW16TT	4
2.0 (H5G)	65	3Y		01/85-08/89	W16EX-U	3027	0.8	W16TT	IW16TT	IW16TT	4
2.2 4WD	69	4Y		09/87-08/89	W16EX-U	3027	0.8	W16TT	IW16TT	IW16TT	4
2.2 D	49	L		03/83-11/89	DG-215		7V				4
2.2 D (H5G)	49	L		03/83-11/89	DG-215		7V				4
2.4 D	55	2L		05/84-11/89	DG-211		11V				4
2.4 D	55	2L		05/84-08/87	DG-221		11V				4
2.4 D	55	2L	QuickGlow System.SGS	05/84-11/89	DG-215		7V				4
2.4 D (H5G)	55	2L		08/84-08/89	DG-211		11V				4
2.4 D (H5G)	55	2L		08/84-08/87	DG-221		11V				4
2.4 D (H5G)	55	2L	QuickGlow System.SGS	08/84-08/89	DG-215		7V				4
2.4 D 4WD	55	2L		04/84-07/87	DG-215		7V				4
2.4 D 4WD (H5F)	54	2L		01/87-01/88	DG-211		11V				4
2.4 D 4WD (H5F)	54	2L	QuickGlow System.SGS	01/87-01/88	DG-215		7V				4
HIACE III (87-04)											
1.8	58			08/87-04/95	W16EX-U	3027	0.8	W16TT	IW16TT	IW16TT	4
2.0	74	1RZ		02/90-08/95	W16EXR-U	3031	0.8	W16TT	IW16TT	IW16TT	4
2.0 (RZH102)	74	1RZ		08/89-04/98	W16EXR-U	3031	0.8	W16TT	IW16TT	IW16TT	4
2.4	85/88	2RZ-E		08/89-04/98	P16R	3004	1.0	W20TT	IW20TT	IW20TT	4
2.4 (RZH103)	88	2RZ-E		08/89-08/95	P16R	3004	1.0	W20TT	IW20TT	IW20TT	4
2.4 4WD	88	2RZ-E		08/89-08/95	P16R	3004	1.0	W20TT	IW20TT	IW20TT	4
2.4 D	53/55/57	2L		09/89-08/95	DG-211		11V				4
2.4 D (LH102)	55	2L		08/89-08/95	DG-211		11V				4
2.4 D 4WD	55/57	2L		08/89-08/95	DG-211		11V				4
2.5 D-4D 4WD	75	2KD-FTV		08/01-08/04	DG-245		11V				4
3.0 D	65	5L		08/01-10/03	DG-212		11V				4
3.0 D	65	5L		08/98-08/04	DG-242		11V				4
HIACE IV (95-)											
2.4 (RCH12_, RCH22_)	85	2RZ-E		08/95-02/05	P16R	3004	1.0	W20TT	IW20TT	IW20TT	4



Spark & Glow Plugs







Application Tables

	KW										QTY
TOYOTA <i>continued</i>											
HIACE IV (95-) continued											
2.4 4WD (RCH18_)	85	2RZ-E		08/95-04/98	P16R	3004	1.0	W20TT	IW20TT	IW20TT	4
2.4 4WD (RCH18_, RCH28_)	85	2RZ-E		08/95-04/98	P16R	3004	1.0	W20TT	IW20TT	IW20TT	4
2.4 D	55/58/61	2L		08/95-08/06	DG-211		11V				4
2.4 D	55	2L		08/96-08/01	DG-212		11V				4
2.4 D	55/58/61	2L		08/95-08/06	DG-242		11V				4
2.4 D (LXH12_, LXH22_)	58	2L		08/95-03/98	DG-211		11V				4
2.4 D (LXH12_, LXH22_)	58	2L		04/98-08/06	DG-242		11V				4
2.4 i (RZH10)	88	2RZ-E		08/95-02/05	P16R	3004	1.0	W20TT	IW20TT	IW20TT	4
2.4 TD (LXH12_, LXH22_)	66	2L-T		08/95-03/98	DG-211		11V				4
2.4 TD (LXH12_, LXH22_)	66	2L-T		04/98-08/01	DG-218		11V				4
2.4 TD 4WD (H18/28)	66	2L-T		08/95-03/98	DG-211		11V				4
2.4 TD 4WD (H18/28)	66	2LT		04/98-08/01	DG-218		11V				4
2.4 TD 4WD (LXH18_, LXH28_)	66	2L-T		08/95-03/98	DG-211		11V				4
2.4 TD 4WD (LXH18_, LXH28_)	66	2L-T		04/98-08/01	DG-218		11V				4
2.5 D-4D	65/70/75/86	2KD-FTV		11/01-	DG-245		11V				4
2.5 D-4D 4WD	75/86	2KD-FTV		11/01-	DG-245		11V				4
2.7	106	3RZ-FE		11/01-05/06	SK16R11	3324	1.1	-	IK16TT	IK16TT	4
2.7 (RCH13_, RCH23_)	105	3RZ-FE		08/01-05/06	SK16R11	3324	1.1	-	IK16TT	IK16TT	4
2.7 (RCH13_, RCH23_)	105	3RZ-FE		04/98-08/01	SK16R-P8	3303	0.8	-	IK16TT	IK16TT	4
2.7 4WD	106	3RZ-FE	LPG / GPL	11/01-05/06	SK16R11	3324	1.1	-	IK16TT	IK16TT	4
2.7 4WD	106	3RZ-FE		11/01-05/06	SK16R-P8	3303	0.8	-	IK16TT	IK16TT	4
2.7 4WD (RCH19_)	105	3RZ-FE		08/01-05/06	SK16R11	3324	1.1	-	IK16TT	IK16TT	4
2.7 4WD (RCH19_)	105	3RZ-FE		04/98-08/01	SK16R-P8	3303	0.8	-	IK16TT	IK16TT	4
2.7 4WD (RCH19_, RCH29_)	106	3RZ-FE		08/01-05/06	SK16R11	3324	1.1	-	IK16TT	IK16TT	4
2.7 4WD (RCH19_, RCH29_)	106	3RZ-FE		04/98-08/01	SK16R-P8	3303	0.8	-	IK16TT	IK16TT	4
3.0 D	65	5L		08/98-08/04	DG-242		11V				4
HIACE V (05-)											
2.5 D-4D	70/75/86	2KD-FTV		09/06-	DG-245		11V				4
2.5 D-4D 4WD	94	2KD-FTV		01/05-	DG-245		11V				4
2.7 VVTi	111	2TR-FE		01/05-	SK20HR11	3421	1.1	-	IKH20TT	IKH20TT	4
2.7 VVTi (TRH201, TRH221)	111	2TR-FE		01/05-	SK20HR11	3421	1.1	-	IKH20TT	IKH20TT	4
HILUX I (72-83)											
1,6	49	12R		09/73-12/78	W16EXR-U	3031	0.8	W16TT	IW16TT	IW16TT	4
1,6	49	12R		05/72-09/73	W20EX-U	3062	0.8	W20TT	IW20TT	IW20TT	4
2.0 (RN3_, RN4_)	65	18R		01/79-07/83	W16EXR-U	3031	0.8	W16TT	IW16TT	IW16TT	4
2.0 4WD	65	18R		01/79-07/83	W16EXR-U	3031	0.8	W16TT	IW16TT	IW16TT	4
HILUX II (83-05)											
1.8	58	2Y		08/83-07/88	W16EX-U	3027	0.8	W16TT	IW16TT	IW16TT	4
1.8 (YN85_, YN90_)	61	2Y		08/88-07/94	W16EXR-U	3031	0.8	W16TT	IW16TT	IW16TT	4
2.0	65	3Y		01/84-12/86	W16EX-U	3027	0.8	W16TT	IW16TT	IW16TT	4
2.0 4WD	65	3Y		08/85-07/88	W16EX-U	3027	0.8	W16TT	IW16TT	IW16TT	4
2.2 (YN106)	69	4Y		01/89-12/89	W16EXR-U	3031	0.8	W16TT	IW16TT	IW16TT	4
2.2 4WD (YN106_, YN110_)	69	4Y		01/87-12/89	W16EX-U	3027	0.8	W16TT	IW16TT	IW16TT	4
2.2 D	49	L		08/83-08/84	DG-221		11V				4
2.2 D 4WD (LN4_, LN5_)	49	L		08/83-08/84	DG-215		7V				4
2.4	75	22R		10/88-12/97	W16EXR-U	3031	0.8	W16TT	IW16TT	IW16TT	4
2.4 4WD	75	22R		10/88-12/97	W16EXR-U	3031	0.8	W16TT	IW16TT	IW16TT	4
2.4 D	56/58/59/61	2L		08/88-07/05	DG-211		11V				4
2.4 D	58/59/61	2L		08/88-07/05	DG-221		11V				4
2.4 D (LN150, LN145)	55	2L		07/98-01/02	DG-211		11V				4
2.4 D 4WD	55/58/61	2L		01/84-07/05	DG-211		11V				4
2.4 i 4WD	103	2RZ-FE		08/97-07/05	K16R-U	3119	0.8	K16TT	IK16TT	IK16TT	4

Spark & Glow Plugs







Application Tables







	KW					Standard			Twin Tip			QTY
TOYOTA <i>continued</i>												
HILUX II (83-05) <i>continued</i>												
2.4 i 4WD	84	22R; 22RE		06/89-07/05	W16EXR-U	3031	0.8		W16TT	IW16TT	IW16TT	4
2.4 TD 4WD	66	2L-T		08/98-01/02	DG-211		11V					4
2.4 TD 4WD	66	2L-T		08/98-07/01	DG-218		11V					4
2.5 D-4D	65	2KD-FTV		11/01-07/05	DG-245		11V					4
2.5 D-4D 4WD	75	2KD-FTV		11/01-07/05	DG-245		11V					4
3.0 D	67	5L		08/02-07/04	DG-310		11V					4
HILUX III (05-)												
2.5 D 4WD	75	2KD-FTV		08/05-	DG-245		11V					4
2.5 D-4D	75/ 88/ 106	2KD-FTV		12/07-	DG-245		11V					4
2.5 D-4D 4WD	88/ 106	2KD-FTV		12/07-	DG-245		11V					4
3.0 (KUN16)	120	1KD-FTV		08/05-09/06	DG-245		11V					4
3.0 D (KUN16)	126	1KD-FTV		10/06-	DG-245		11V					4
3.0 D-4D 4WD	126	1KD-FTV		12/07-	DG-245		11V					4
IQ (09-)												
1.0	50	1KR-FE		11/13-	SC16HR11	3499	1.1	-	IXEH20TT	IXEH20TT		3
1.0	50	1KR-FE		01/09-	SK16HR11	3417	1.1	-	IKH16TT	IKH16TT		3
1.33	69/72	1NR-FE		11/13-	SC16HR11	3499	1.1	-	IXEH20TT	IXEH20TT		4
1.33	69/72	1NR-FE		01/09-11/13	SC20HR11	3444	1.1	-	IXEH22TT	IXEH22TT		4
1.4 D-4D	66	1ND-TV		01/09-10/10	DG-240		11V					4
ISIS (04-)												
1.8 VVTi	106	2ZR-FAE		04/07-	SC20HR11	3444	1.1	-	IXEH22TT	IXEH22TT		4
1.8 VVTi 4WD	98	2ZR-FAE		04/07-	SC20HR11	3444	1.1	-	IXEH22TT	IXEH22TT		4
IST (04-07)												
1.5 VVTi	80	1NZ-FE		05/04-07/07	K16R-U11	3120	1.1		K16TT	IK16TT	IK16TT	4
KLUGER / HIGHLANDER I (00-07)												
2.4	115/ 118	2AZ-FE		06/00-05/07	SK20R11	3297	1.1	-	IK20TT	IK20TT		4
2.4 4WD	115/ 118	2AZ-FE		06/00-09/03	SK20R11	3297	1.1	-	IK20TT	IK20TT		4
3.0	164	1MZ-FE		06/00-05/07	SK20R11	3297	1.1	-	IK20TT	IK20TT		6
3.0 4WD	150/ 164	1MZ-FE		06/00-05/07	SK20R11	3297	1.1	-	IK20TT	IK20TT		6
3.3	171	3MZ-FE		10/03-05/07	SK20R11	3297	1.1	-	IK20TT	IK20TT		6
3.3 4WD	171	3MZ-FE		10/03-05/07	SK20R11	3297	1.1	-	IK20TT	IK20TT		6
3.3 Hybrid	200	3MZ-FE		03/05-05/07	SK20R11	3297	1.1	-	IK20TT	IK20TT		6
3.3 Hybrid 4WD	200	3MZ-FE		03/05-05/07	SK20R11	3297	1.1	-	IK20TT	IK20TT		6
KLUGER / HIGHLANDER II (07-)												
2.7 VVTi	140	1AR-FE		05/07-	SK16HR11	3417	1.1	-	IKH16TT	IKH16TT		4
2.7 VVTi 4WD	140	1AR-FE		05/07-	SK16HR11	3417	1.1	-	IKH16TT	IKH16TT		4
3.5	201	2GR-FE		05/07-	FK20HR11	3426	1.1	-	IKH20TT	IKH20TT		6
3.5 4WD	201	2GR-FE		05/07-	FK20HR11	3426	1.1	-	IKH20TT	IKH20TT		6
LAND CRUISER (J40) (69-86)												
3.0 D (BJ40_V, BJ43_)	59	B		02/74-10/84	DG-001		11V					4
3.0 D (BJ40_V, BJ43_)	59	B		02/74-10/74	DG-226		19V					4
3.0 D (BJ40_V, BJ43_)	59	B		02/74-01/75	DG-227		8V					4
3.4 D (BJ42_V, BJ45_V, BJ46_)	66	3B		10/82-10/83	DG-220		6V					4
3.4 D (BJ42_V, BJ45_V, BJ46_)	66	3B		08/80-10/84	DG-222		14V					4
3.4 D (BJ42_V, BJ45_V, BJ46_)	66	3B		08/80-10/83	DG-232		10.5V					4
3.4 D (BJ42_V, BJ45_V, BJ46_)	66	3B		08/80-10/83	DG-233		23V					4
3.4 D (BJ42_V, BJ45_V, BJ46_)	66	3B		08/80-10/84	DG-234		8.5V					4
3.4 D (BJ42_V, BJ45_V, BJ46_)	66	3B		08/80-10/83	DG-235		20.5V					4
3.4 D (BJ45_P)	66	3B		10/82-10/83	DG-220		6V					4
3.4 D (BJ45_P)	66	3B		08/80-10/84	DG-222		14V					4
3.4 D (BJ45_P)	66	3B		08/80-10/83	DG-232		10.5V					4
3.4 D (BJ45_P)	66	3B		08/80-10/83	DG-233		23V					4
3.4 D (BJ45_P)	66	3B		08/80-10/84	DG-234		8.5V					4
3.4 D (BJ45_P)	66	3B		08/80-10/83	DG-235		20.5V					4
3.6 D (HJ45_P)	66	H		01/75-07/80	DG-224		8V					6
3.6 D (HJ45_P)	66	H		01/75-07/80	DG-225		19V					6
3.6 D (HJ45_V)	66	H		04/79-07/80	DG-224		8V					6
3.6 D (HJ45_V)	66	H		04/79-07/80	DG-225		19V					6
4.0 D (HJ47_P)	76	2H		08/80-10/84	DG-214		11V					6
4.0 D (HJ47_P)	76	2H		08/80-10/84	DG-222		14V					6

	KW					Standard		Twin Tip		QTY	
TOYOTA <i>continued</i>											
LAND CRUISER (J40) (69-86) <i>continued</i>											
4.0 D (HJ47_P)	76	2H	OE: 19850-68020	08/80-10/84	DG-233		23V			6	
4.0 D (HJ47_V)	76	2H		08/80-10/84	DG-214		11V			6	
4.0 D (HJ47_V)	76	2H		08/80-10/84	DG-222		14V			6	
4.0 D (HJ47_V)	76	2H	OE: 19850-68020	08/80-10/84	DG-233		23V			6	
4.2 (FJ40_V, FJ43_V, FJ45_V, FJ55_V)	89	2F		01/75-04/86	W14EX-U	3011	0.8	-	IW16TT	IW16TT	6
4.2 (FJ45_P)	89	2F		01/75-04/86	W14EX-U	3011	0.8	-	IW16TT	IW16TT	6
LAND CRUISER (J60) (81-89)											
3.4 Diesel (BJ60_V)	66	3B		10/81-08/87	DG-222		14V			4	
3.4 Diesel (BJ60_V)	66	3B		10/81-08/87	DG-234		8.5V			4	
4.0 (FJ62_G)	115	3F-E		08/87-12/89	W16EXR-U11	3032	1.1	W16TT	IW16TT	IW16TT	6
4.0 (FJ62_V)	101	3F		11/84-08/87	W14EX-U	3011	0.8	-	IW16TT	IW16TT	6
4.0 Diesel (HJ60)	76	2H		01/85-12/87	DG-214		11V			6	
4.0 Diesel (HJ60)	74	2H		01/82-12/85	DG-220		6V			6	
4.0 Diesel (HJ60)	74/76	2H		01/82-12/87	DG-222		14V			6	
4.0 Diesel (HJ60)	74	2H		01/82-12/85	DG-232		10.5V			6	
4.0 Diesel (HJ60)	74/76	2H	OE: 19850-68020	01/82-12/87	DG-233		23V			6	
4.0 Diesel (HJ60_V)	77	2H		10/81-01/88	DG-214		11V			6	
4.0 Diesel (HJ60_V)	77	2H		10/81-01/88	DG-222		14V			6	
4.0 Turbo-D (HJ61_V)	100	12HT		10/85-12/89	DG-219		23V			4	
4.2 (FJ60_V)	88	2F		10/81-01/88	W14EXR-U	3013	0.8	-	IW16TT	IW16TT	6
LAND CRUISER (J80) (90-98)											
4.0 (FJ80_V)	115	3F-E		01/90-08/92	W16EXR-U	3031	0.8	W16TT	IW16TT	IW16TT	6
4.2 D (HZJ80_V)	99	1H-Z		01/90-12/97	DG-214		11V			6	
4.2 TD (HDJ80)	118/123	1HD-T		01/90-12/97	DG-214		11V			6	
4.2 TD (HDJ80)	123	1HD-T		01/90-12/97	DG-219		23V			6	
4.2 TD 24V (HDJ80_V)	125	1HD-FT		03/95-12/97	DG-219		23V			6	
4.5 24V (FZJ80_V)	151	1FZ-FE		08/92-12/97	K16R-U	3119	0.8	K16TT	IK16TT	IK16TT	6
LAND CRUISER (J100) (98-08)											
4.2 TD (HDJ100_V)	150	1HD-FTE		01/98-07/07	DG-214		11V			6	
4.2 TD (HDJ100_V)	150	1HD-FTE		01/98-07/07	DG-235		20.5V			6	
4.7 (UZJ100)	175	2UZ-FE		02/02-	SK20R11	3297	1.1	-	IK20TT	IK20TT	8
4.7 (UZJ100_V)	173	2UZ-FE		01/98-07/02	K20R-U	3122	0.8	K20TT	IK20TT	IK20TT	8
4.7 (UZJ100_V)	173	2UZ-FE		08/02-	SK20R11	3297	1.1	-	IK20TT	IK20TT	8
LAND CRUISER (J200) (07-)											
4.5 D V8 (VDJ200)	210	1VD-FTV		01/08-	DG-600		11V			8	
4.5 D4-D	173/200	1VD-FTV		08/07-	DG-600		11V			8	
4.5 D-4D (VDJ200)	195	1VD-FTV		01/08-	DG-600		11V			8	
4.6 V8	227	1UR-FE		09/10-	SK20HR11	3421	1.1	-	IKH20TT	IKH20TT	8
4.6 V8 (URJ202W_V)	234	1UR-FE		01/12-	SK20HR11	3421	1.1	-	IKH20TT	IKH20TT	8
4.7 V8 (UZJ200)	202/212	2UZ-FE		08/07-	SK20R11	3297	1.1	-	IK20TT	IK20TT	8
5.7 V8	268/284	3UR-FE		08/07-	SK20HR11	3421	1.1	-	IKH20TT	IKH20TT	8
LAND CRUISER / PRADO (J70) (84-06)											
2.4 (RJ70_V, RJ73_V)	77/81	22R		11/84-05/93	W16EXR-U	3031	0.8	W16TT	IW16TT	IW16TT	4
2.4 (RJ70_V, RJ73_V)	84	22RE		12/88-12/96	W16EXR-U	3031	0.8	W16TT	IW16TT	IW16TT	4
2.4 D (LJ70_V)	53	2L		11/84-10/85	DG-215		7V			4	
2.4 TD (LJ70)	66	2L-T		01/90-05/93	DG-211		11V			4	
2.4 TD (LJ70)	66	2LT;2L-T		01/90-05/93	DG-213		6V			4	
2.4 TD (LJ70_V, LJ73_V)	63	2L-T		10/85-05/90	DG-211		11V			4	
2.4 TD (LJ77)	66	2L-T		07/90-05/96	DG-211		11V			4	
3.0 TD	92	1KZ-T		05/93-05/96	DG-305		11V			4	
3.0 TD (KZJ70_V, KZJ73_V, KZJ77_V)	92	1KZ-T		05/93-05/96	DG-305		11V			4	
3.4 D (BJ70_V, BJ73_V)	70	3B		08/88-12/96	DG-219		23V			4	
3.4 D (BJ70_V, BJ73_V)	70	3B		11/84-08/88	DG-220		6V			4	
3.4 D (BJ70_V, BJ73_V)	70	3B		11/84-12/96	DG-222		14V			4	
3.4 D (BJ70_V, BJ73_V)	70	3B		11/84-08/87	DG-232		10.5V			4	
3.4 D (BJ70_V, BJ73_V)	70	3B		11/84-10/85	DG-233		23V			4	
3.4 TD (BJ71_V)	91	13BT		10/85-08/86	DG-222		14V			4	
3.5 D 4x4 (PZJ75, PZJ70)	85	1PZ		01/90-12/94	DG-219		23V			4	
4.0 D 4x4	74	2H		08/87-12/89	DG-220		6V			6	
4.0 D 4x4	74	2H		08/87-12/89	DG-232		10.5V			6	
4.0 D 4x4	74	2H	OE: 19850-68020	08/87-12/89	DG-233		23V			6	

Spark & Glow Plugs







Application Tables

	KW				Standard 			Twin Tip 			QTY
TOYOTA <i>continued</i>											
LAND CRUISER / PRADO (J70) (84-06) <i>continued</i>											
4.2 D	123	1H-Z		07/90-05/96	DG-219		23V				4
4.2 TD (HZJ7__V)	96	1H-Z		04/96-08/01	DG-219		23V				6
4.2 TD 4x4	100	1H-Z		03/07-	DG-219		23V				4
4.2 TD 4x4 (HZJ7__V)	96	1H-Z		01/90-08/99	DG-219		23V				6
4.2 TD 4x4 (HZJ7__V)	96	1H-Z		08/99-08/01	DG-232		10.5V				6
4.2 TD 4x4 (HZJ74, HZJ78, HZJ75)	123	1H-Z		08/90-08/99	DG-219		23V				6
4.2 TD 4x4 (HZJ74, HZJ78, HZJ75)	123	1H-Z		08/99-08/01	DG-232		10.5V				6
LAND CRUISER / PRADO (J120) (02-10)											
2.7 (RZJ12)	112	3RZ-FE		09/02-08/04	K16R-U11	3120	1.1	K16TT	IK16TT	IK16TT	4
2.7 (TRJ12)	120	2TR-FE		11/03-02/10	SK20HR11	3421	1.1	-	IKH20TT	IKH20TT	4
3.0 D-4D (KDJ120, KDJ125)	122/ 127	1KD-FTV		09/02-	DG-245		11V				4
3.0 D-4D (KDJ120, KDJ150, KDJ125)	120	1KD-FTV		01/03-10/06	DG-245		11V				4
3.0 D-4D (KZJ12)	92	1KZ-TE		09/02-02/10	DG-305		11V				4
4.0 (GRJ12, GRJ125)	183	1GR-FE		01/03-	K20HR-U11	3381	1.1	KH20TT	IKH20TT	IKH20TT	6
LAND CRUISER / PRADO (J150) (10-)											
2.7	120	2TR-FE		01/10-	SK20HR11	3421	1.1	-	IKH20TT	IKH20TT	4
3.0 D-4D	127/ 140	1KD-FTV		01/10-	DG-245		11V				4
4.0 V6 Dual VVTi	205	1GR-FE		01/10-10/11	SK20HR11	3421	1.1	-	IKH20TT	IKH20TT	6
4.0 V6 VVTi	183/ 203	1GR-FE		01/10-10/11	SK20HR11	3421	1.1	-	IKH20TT	IKH20TT	6
4.0 V6 VVT-i	207	1GR-FE		01/10-10/11	SK20HR11	3421	1.1	-	IKH20TT	IKH20TT	6
LAND CRUISER / PRADO / COLORADO (J90) (95-)											
3.0 D-4D (KDJ90, KDJ95, KDJ 125)	120	1KD-FTV		10/00-08/02	DG-245		11V				4
3.0 TD (KZJ90__, KZJ95_)	92	1KZ-TE		04/96-	DG-305		11V				4
3.4 i 24V (VZJ90_, VZJ95_)	131	5VZ-FE		04/96-	K16TR11	3194	1.1	K16TT	IK16TT	IK16TT	6
4.7	175	2UZ-FE		08/02-	SK20R11	3297	1.1	-	IK20TT	IK20TT	8
LITEACE (79-86)											
1.3	42/43	4K		10/79-10/86	W16EXR-U	3031	0.8	W16TT	IW16TT	IW16TT	4
1.8 D	41	1C		10/82-09/85	DG-223		7V				4
1.8 D	41	1C		10/82-09/85	DG-232		10.5V				4
LITEACE (84-92)											
1.5 (KM30LG)	51/52	5K		10/85-01/92	W16EXR-U	3031	0.8	W16TT	IW16TT	IW16TT	4
1.5 (KM31_V, KM36_V)	51	5K		05/86-09/91	W16EXR-U	3031	0.8	W16TT	IW16TT	IW16TT	4
1.8 D (CM35_V)	46	1C		10/85-08/88	DG-223		7V				4
2.0 D (CM30LG)	53	2C		08/88-01/92	DG-214		11V				4
2.0 D (CM30LG)	53	2C		08/88-01/92	DG-216		11V				4
2.0 D (CM36_V)	53	2C		08/88-01/92	DG-214		11V				4
2.0 D (CM36_V)	53	2C		08/88-01/92	DG-216		11V				4
LITEACE (92-97)											
1.5 (KR21LG)	52	5K		01/92-01/95	W16EXR-U	3031	0.8	W16TT	IW16TT	IW16TT	4
1.5 (KR27_V)	52	5K		01/92-01/95	W16EXR-U	3031	0.8	W16TT	IW16TT	IW16TT	4
2.0 D (CR21LG)	53	2C		01/92-05/94	DG-214		11V				4
2.0 D (CR21LG)	53	2C		01/92-05/94	DG-216		11V				4
2.0 D (CR27_V)	51	2C		01/92-05/94	DG-214		11V				4
2.0 D (CR27_V)	51	2C		01/92-05/94	DG-216		11V				4
2.2 (YR22LG)	72	4Y-EC		01/92-01/95	P16R	3004	1.0	W20TT	IW20TT	IW20TT	4
2.2 (YR29LV)	72	4Y-EC		01/92-01/95	P16R	3004	1.0	W20TT	IW20TT	IW20TT	4
MAJESTA (99-03)											
4.0	206	1UZ-FE		09/99-08/03	PK20R11	3128	1.1	K20TT	IK20TT	IK20TT	8
MARK II (80-01)											
2.2	96	5S-FE		08/96-07/01	PK20TR11	3253	1.1	K20TT	IK20TT	IK20TT	4
2.4 TD	69/71	2L-TE		11/84-09/96	DG-310		11V				4
MARK X I (04-09)											
2.5 VVTi	158	4GR-FSE		03/04-09/09	FK20HBR11	3473	1.1	-	IKBH20TT	IKBH20TT	6
2.5 VVTi 4WD	158	4GR-FSE		05/04-09/09	FK20HBR11	3473	1.1	-	IKBH20TT	IKBH20TT	6
3.0 VVTi	183	3GR-FSE		05/04-09/07	FK20HBR11	3473	1.1	-	IKBH20TT	IKBH20TT	6
3.0 VVTi	183	3GR-FSE		09/07-09/09	FK20HR11	3426	1.1	-	IKH20TT	IKH20TT	6
MARK X II (09-)											
2.5	149	4GR-FSE		10/09-	FK20HBR11	3473	1.1	-	IKBH20TT	IKBH20TT	6
2.5 4WD	149	4GR-FSE		10/09-	FK20HBR11	3473	1.1	-	IKBH20TT	IKBH20TT	6
3.5	234	2GR-FSE		10/09-	FK20HBR11	3473	1.1	-	IKBH20TT	IKBH20TT	6
MARK X ZiO (07-)											
3.5	206	2GR-FE		09/07-	FK20HR11	3426	1.1	-	IKH20TT	IKH20TT	6

	KW					Standard			Twin Tip			QTY
TOYOTA <i>continued</i>												
MODELL F (82-90)												
1.8 De Luxe (YR20)	58	2Y-C		11/82-08/84	W16EXR-U	3031	0.8	W16TT	IW16TT	IW16TT		4
2.0 (YR21_G)	66	3Y		08/88-01/90	W16EX-U	3027	0.8	W16TT	IW16TT	IW16TT		4
2.0 D	49	2C	OE: 1985064010	04/85-07/87	DG-223		7V					4
2.0 Super (YR21)	65	3Y		08/84-08/88	W16EXR-U	3031	0.8	W16TT	IW16TT	IW16TT		4
2.2 (YR22LG, YR31LG)	72	4Y-EC		08/87-01/90	P16R	3004	1.0	W20TT	IW20TT	IW20TT		4
MR 2 I (84-90)												
1.6 16V (AW11)	85	4A-GELC		11/84-06/90	PQ16R	3005	1.1	Q16TT	IQ16TT	IQ16TT		4
1.6 16V (AW11)	91	4A-GEL		11/84-06/90	Q20R-U11	3009	1.1	Q20TT	IQ20TT	IQ20TT		4
MR 2 II (89-00)												
2.0	88	3S-FE		12/89-08/92	PK20R11	3128	1.1	K20TT	IK20TT	IK20TT		4
2.0 16V	125	3S-GE		12/89-05/00	K20R-U	3122	0.8	K20TT	IK20TT	IK20TT		4
2.0 16V	129	3S-GE		12/89-05/00	PK20R8	3127	0.8	-	IK20TT	IK20TT		4
2.0 16V (SW20)	115	3S-GE		12/89-05/00	K20R-U	3122	0.8	K20TT	IK20TT	IK20TT		4
2.0 16V (SW20)	115	3S-GE		12/89-05/00	PK20R8	3127	0.8	-	IK20TT	IK20TT		4
2.0 Turbo	167	3S-GTE		12/89-09/99	PK20R8	3127	0.8	-	IK20TT	IK20TT		4
MR 2 III (99-07)												
1.8 16V VT-i (ZZW30)	103	1ZZ-FE		10/99-06/07	K16R-U11	3120	1.1	K16TT	IK16TT	IK16TT		4
NADIA (98-03)												
2.0 4WD	107	3S-FSE		04/98-08/03	PK20GR8	3326	0.8	-	-	VKA20		4
PASEO (95-99)												
1.3	65	4E-FE		08/95-06/99	K16TR11	3194	1.1	K16TT	IK16TT	IK16TT		4
1.5	66	5E-FE		10/96-01/98	PK16R8	3301	0.8	-	IK16TT	IK16TT		4
1.5 16V	66	5E-FE		08/95-07/99	PK16R11	3134	1.1	K16TT	IK16TT	IK16TT		4
PICNIC (96-01)												
2.0	90	3S-FE		01/01-12/01	Q16R-U11	3006	1.1	Q16TT	IQ16TT	IQ16TT		4
2.0 16V (SXM10_)	94	3S-FE		05/96-12/01	K20TR11	3195	1.1	K20TT	IK20TT	IK20TT		4
2.2 D (CMX10_)	66	3C-TE		08/97-12/01	DG-305		11V					4
PIXIS (11-)												
0.7	38	KF-VE		10/11-	VXUH20I			-	-	VXUH20I		3
0.7	38/47	KF-VE		12/12-	XU20HR9		0.9	-	-			3
0.7 4WD	38	KF-VE		10/11-	VXUH20I			-	-	VXUH20I		3
0.7 4WD	38/47	KF-VE		11/12-	XU20HR9		0.9	-	-			3
PLATZ (99-05)												
1.5 VVTi	78	1NZ-FE		04/99-08/05	K16R-U11	3120	1.1	K16TT	IK16TT	IK16TT		4
1.5 VVTi 4WD	78	1NZ-FE		09/02-08/05	K16R-U11	3120	1.1	K16TT	IK16TT	IK16TT		4
PORTE I (04-12)												
1.5 4WD	77	1NZ-FE		07/04-07/12	K16R-U11	3120	1.1	K16TT	IK16TT	IK16TT		4
1.5 VVTi	81	1NZ-FE		07/04-07/12	K16R-U11	3120	1.1	K16TT	IK16TT	IK16TT		4
PORTE II (12-)												
1.5	80	1NZ-FE		08/12-	VFKH16	5654	1.1	-	IKH16TT	IKH16TT		4
1.5 4WD	76	1NZ-FE		08/12-	VFKH16	5654	1.1	-	IKH16TT	IKH16TT		4
PREMIO (07-)												
1.5	81	1NZ-FE		07/07-	VFKH16	5654	1.1	-	IKH16TT	IKH16TT		4
1.8	106	2ZR-FAE		07/07-	SC20HR11	3444	1.1	-	IXEH22TT	IXEH22TT		4
1.8 4WD	98	2ZR-FAE		07/07-	SC20HR11	3444	1.1	-	IXEH22TT	IXEH22TT		4
PREVIA I (90-00)												
2.4	97	2TZ-FE		05/90-08/00	PK16R11	3134	1.1	K16TT	IK16TT	IK16TT		4
2.4 4WD	97	2TZ-FE		05/90-08/00	K16R-U	3119	0.8	K16TT	IK16TT	IK16TT		4
PREVIA II (00-06)												
2.0 D-4D	85	1CD-FTV		03/01-01/06	DG-245		11V					4
2.4	115	2AZ-FE		08/00-01/06	K20R-U11	3139	1.1	K20TT	IK20TT	IK20TT		4
2.4	125	2AZ-FE		10/05-01/06	SK20R11	3297	1.1	-	IK20TT	IK20TT		4
2.4	115	2AZ-FE	LEAN BURN	08/00-01/06	SK20R11	3297	1.1	-	IK20TT	IK20TT		4
2.4 4WD	125	2AZ-FE		10/05-01/06	SK20R11	3297	1.1	-	IK20TT	IK20TT		4
3.0 VVTi	162	1MZ-FE		08/00-12/05	SK20R11	3297	1.1	-	IK20TT	IK20TT		6
3.0 VVTi 4WD	162	1MZ-FE		02/00-12/05	SK20R11	3297	1.1	-	IK20TT	IK20TT		6
3.5	206	2GR-FE		02/00-01/06	FK20HR11	3426	1.1	-	IKH20TT	IKH20TT		6
3.5 4WD	206	2GR-FE		02/00-01/06	FK20HR11	3426	1.1	-	IKH20TT	IKH20TT		6
PREVIA III (05-)												
3.5	200/ 206	2GR-FE		01/06-	FK20HR11	3426	1.1	-	IKH20TT	IKH20TT		6
3.5 4WD	206	2GR-FE		01/06-	FK20HR11	3426	1.1	-	IKH20TT	IKH20TT		6
PRIUS (00-04)												
1.5 Hybrid	53	1NZ-FXE		05/00-01/04	SK16R11	3324	1.1	-	IK16TT	IK16TT		4
PRIUS (03-09)												
1.5	57	1NZ-FXE		08/03-03/09	SK16R11	3324	1.1	-	IK16TT	IK16TT		4







Spark & Glow Plugs

Application Tables

	KW				Standard 			Twin Tip 				QTY
TOYOTA <i>continued</i>												
PRIUS (09-)												
1.8 Hybrid	73	2ZR-FXE		04/09-	SC20HR11	3444	1.1	-	IXEH22TT	IXEH22TT		4
PRIUS C (12-)												
1.5 Hybrid	54	1NZ-FXE		02/12-	FK16HR-A8		0.8	-	-	FK16HR-A8		4
PRIUS PLUS (11-)												
1.8 Hybrid	73	2ZR-FXE		05/11-	SC20HR11	3444	1.1	-	IXEH22TT	IXEH22TT		4
PROBOX / SUCCEED (02-)												
1.5 VVTi	80	1NZ-FE		07/02-06/10	K16R-U11	3120	1.1	K16TT	IK16TT	IK16TT		4
1.5 VVTi 4WD	77/80	1NZ-FE		07/02-06/10	K16R-U11	3120	1.1	K16TT	IK16TT	IK16TT		4
RACTIS (05-10)												
1.5 VVTi	80	1NZ-FE		09/05-08/10	VFKH16	5654	1.1	-	IKH16TT	IKH16TT		4
1.5 VVTi 4WD	76	1NZ-FE		09/05-08/10	VFKH16	5654	1.1	-	IKH16TT	IKH16TT		4
RAUM (03-)												
1.5	80	1NZ-FE		05/03-	K16R-U11	3120	1.1	K16TT	IK16TT	IK16TT		4
1.5 4WD	77	1NZ-FE		05/03-	K16R-U11	3120	1.1	K16TT	IK16TT	IK16TT		4
RAV 4 I / FUNCRUISER (94-00)												
2.0	99	3S-FE		06/97-09/99	PK20TR11	3253	1.1	K20TT	IK20TT	IK20TT		4
2.0 16V 4WD	94	3S-FE		12/97-06/00	PK20TR11	3253	1.1	K20TT	IK20TT	IK20TT		4
2.0 4WD	99	3S-FE		01/94-08/96	K20R-U11	3139	1.1	K20TT	IK20TT	IK20TT		4
2.0 4WD	99	3S-FE		08/96-09/99	K20TR11	3195	1.1	K20TT	IK20TT	IK20TT		4
2.0 4WD	95	3S-FE		06/94-06/00	PK20TR11	3253	1.1	K20TT	IK20TT	IK20TT		4
RAV 4 II (00-05)												
1.8 VVTi	92	1ZZ-FE		08/00-11/05	K16R-U11	3120	1.1	K16TT	IK16TT	IK16TT		4
2.0 D-4D 4WD	85	1CD-FTV		09/01-11/05	DG-245		11V					4
2.0 VVTi 4WD	110	1AZ-FE		06/00-11/05	K20R-U11	3139	1.1	K20TT	IK20TT	IK20TT		4
2.0 VVTi 4WD	110	1AZ-FE		06/00-11/05	SK20R11	3297	1.1	-	IK20TT	IK20TT		4
2.4 VVTi 4WD	112	2AZ-FE		08/03-11/05	SK20R11	3297	1.1	-	IK20TT	IK20TT		4
RAV 4 III (05-)												
2.0	116	3ZR-FAE		12/08-	SC20HR11	3444	1.1	-	IXEH22TT	IXEH22TT		4
2.0 4WD	116	3ZR-FAE		12/08-	SC20HR11	3444	1.1	-	IXEH22TT	IXEH22TT		4
2.0 VVT-i	109	3ZR-FAE		03/09-	SC20HR11	3444	1.1	-	IXEH22TT	IXEH22TT		4
2.0 VVT-i 4WD	109	3ZR-FAE		03/09-	SC20HR11	3444	1.1	-	IXEH22TT	IXEH22TT		4
2.0 VVT-i 4WD	112	1AZ-FE		03/06-	SK20R11	3297	1.1	-	IK20TT	IK20TT		4
2.2 D-4D	110	2AD-FHV; 2AD-FTV		12/08-	DG-600		11V					4
2.2 D-4D 4WD	100/110	2AD-FHV; 2AD-FTV		03/06-	DG-600		11V					4
2.2 D-CAT 4WD	130	2AD-FHV		03/06-	DG-600		11V					4
2.4 VVTi	125	2AZ-FE		11/05-	SK20R11	3297	1.1	-	IK20TT	IK20TT		4
2.4 VVTi 4WD	125	2AZ-FE		11/05-	SK20R11	3297	1.1	-	IK20TT	IK20TT		4
3.5 4WD	206	2GR-FE		08/07-	FK20HR11	3426	1.1	-	IKH20TT	IKH20TT		6
3.5 VVTi 4WD	201	2GR-FE		11/05-	FK20HR11	3426	1.1	-	IKH20TT	IKH20TT		6
RAV 4 IV (12-)												
2.0 VVT-i	107	3ZR-FAE		12/12-	SC20HR11	3444	1.1	-	IXEH22TT	IXEH22TT		4
2.0 VVT-i 4WD	111	3ZR-FAE		12/12-	SC20HR11	3444	1.1	-	IXEH22TT	IXEH22TT		4
2.2 D4-D 4WD	110	2AD-FHV; 2AD-FTV		12/12-	DG-600		11V					4
2.5 VVT-i 4WD	132	2AR-FE		12/12-	SK16HR11	3417	1.1	-	IKH16TT	IKH16TT		4
RUSH (06-)												
1.5	80	3SZ-VE		03/06-	SXU22PR9	3434	0.9	-	-	VXU22I		4
1.5 4WD	80	3SZ-VE		03/06-	SXU22PR9	3434	0.9	-	-	VXU22I		4
SCEPTER (92-96)												
2.2	100	5S-FE		11/92-09/96	PK20TR11	3253	1.1	K20TT	IK20TT	IK20TT		4
SEQUOIA (00-)												
4.7	175/204	2UZ-FE		05/00-07/02	K20R-U	3122	0.8	K20TT	IK20TT	IK20TT		8
4.7	175/204	2UZ-FE		08/02-11/07	SK20R11	3297	1.1	-	IK20TT	IK20TT		8
4.7 4WD	175	2UZ-FE		05/00-07/02	K20R-U	3122	0.8	K20TT	IK20TT	IK20TT		8
4.7 4WD	175/206	2UZ-FE		08/02-	SK20R11	3297	1.1	-	IK20TT	IK20TT		8
5.7	284	3UR-FE		11/07-	SK20HR11	3421	1.1	-	IKH20TT	IKH20TT		8
SIENNA (97-03)												
3.0	143/154	1MZ-FE		05/97-04/03	K20TR11	3195	1.1	K20TT	IK20TT	IK20TT		6
3.0	143/154	1MZ-FE	OEM Optional	05/97-04/03	PK20TR11	3253	1.1	K20TT	IK20TT	IK20TT		6
SIENNA (03-09)												
3.3 4WD	169	3MZ-FE		05/03-11/09	SK20R11	3297	1.1	-	IK20TT	IK20TT		6
SIENNA (10-)												
3.5 VVTi 4WD	198	2GR-FE		02/10-	FK20HR11	3426	1.1	-	IKH20TT	IKH20TT		6



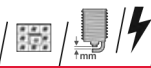



Spark & Glow Plugs

Application Tables

	KW								QTY	
TOYOTA <i>continued</i>										
SOARER (90-00)										
3.0	166	2JZ-GE		09/90-09/00	PK20TR11	3253 1.1	K20TT	IK20TT	IK20TT	6
SOLUNA Vios (02-)										
1.3 VVTi	64	8A-FE		07/02-	FK16R11	3440 1.1	-	-	VFK16	4
1.5	68			07/02-	FK16R11	3440 1.1	-	-	VFK16	4
SPADE (12-)										
1.5	80	1NZ-FE		08/12-	VFKH16	5654 1.1	-	IKH16TT	IKH16TT	4
1.5 4WD	76	1NZ-FE		08/12-	VFKH16	5654 1.1	-	IKH16TT	IKH16TT	4
SPRINTER (82-02)										
1.3	55	2E-E		08/87-04/92	W16EXR-U	3031 0.8	W16TT	IW16TT	IW16TT	4
1.3	55	2E; 2E-L		06/83-04/92	W16EXR-U11	3032 1.1	W16TT	IW16TT	IW16TT	4
1.6	54	4A-LC		10/84-07/87	W16EXR-U	3031 0.8	W16TT	IW16TT	IW16TT	4
STARLET (P6) (78-84)										
1.0 (KP60)	33	2K		02/78-09/84	W16EXR-U	3031 0.8	W16TT	IW16TT	IW16TT	4
1.2	41	3K-H		02/78-09/82	W16EX-U	3027 0.8	W16TT	IW16TT	IW16TT	4
1.2 S (KP62)	39	3K-H		10/78-08/82	W16EX-U	3027 0.8	W16TT	IW16TT	IW16TT	4
1.3	44	4K-C		09/82-09/84	W16EX-U	3027 0.8	W16TT	IW16TT	IW16TT	4
1.3 S (KP61)	48	4K		08/82-09/84	W16EXR-U	3031 0.8	W16TT	IW16TT	IW16TT	4
STARLET (P7) (84-89)										
1.0 (EP70L)	40	1E-L		10/84-12/89	W20EXR-U	3066 0.8	W20TT	IW20TT	IW20TT	4
1.3	52	2E-LC		08/87-11/89	W16EXR-U11	3032 1.1	W16TT	IW16TT	IW16TT	4
1.3	52	2E-LC		10/84-08/87	W20EXR-U11	3067 1.1	W20TT	IW20TT	IW20TT	4
1.3 (EP71L)	55	2E-LC		08/87-12/89	W16EXR-U11	3032 1.1	W16TT	IW16TT	IW16TT	4
1.3 (EP71L)	55	2E-LC		10/84-08/87	W20EXR-U11	3067 1.1	W20TT	IW20TT	IW20TT	4
1.5 D (NP70L)	40	1N		12/86-12/89	DG-215	7V				4
STARLET (P8) (89-96)										
1.0 (EP80_)	40	1E		12/89-12/92	W20EXR-U	3066 0.8	W20TT	IW20TT	IW20TT	4
1.3 12V (EP81) CAT	55	SI; XLI		12/93-03/96	W14EXR-U	3013 0.8	-	IW16TT	IW16TT	4
1.3 12V (EP81) CAT	55	2E-E		12/89-05/94	W16EXR-U	3031 0.8	W16TT	IW16TT	IW16TT	4
1.3 12V (EP81_)	55	2E-E		12/89-12/92	W16EXR-U	3031 0.8	W16TT	IW16TT	IW16TT	4
1.3 12V (EP81_)	55	2E		12/89-12/92	W16EXR-U11	3032 1.1	W16TT	IW16TT	IW16TT	4
1.3 XL	52	2E		12/89-12/91	W16EXR-U11	3032 1.1	W16TT	IW16TT	IW16TT	4
1.5 D (NP80_)	40	1N		12/89-03/96	DG-211	11V				4
STARLET (P9) (96-99)										
1.3	55	4E-FE		04/96-03/99	K16TR11	3194 1.1	K16TT	IK16TT	IK16TT	4
STARLET 1000 (74-78)										
1.0	33	2K		11/74-08/78	W16EXR-U	3031 0.8	W16TT	IW16TT	IW16TT	4
SUPRA (81-85)										
2,8 24V	103	5M-GE		08/83-10/83	W14EXR-U	3013 0.8	-	IW16TT	IW16TT	6
2,8 24V	103	5M-GE		10/83-12/85	W16EXR-U	3031 0.8	W16TT	IW16TT	IW16TT	6
SUPRA (86-93)										
3.0 24V	150	7M-GE		01/86-08/88	PQ16R	3005 1.1	Q16TT	IQ16TT	IQ16TT	6
3.0 Turbo	173/175	7M-GTE		09/87-05/93	PQ20R-P8	3113 0.8	-	IQ20TT	IQ20TT	6
SUPRA (93-02)										
3.0 i	168	2JZ-GE		05/93-05/96	K20R-U	3122 0.8	K20TT	IK20TT	IK20TT	6
3.0 i	168	2JZ-GE		06/96-12/00	PK16TR11	3289 1.1	K16TT	IK16TT	IK16TT	6
3.0 i	168	2JZ-GE		01/01-08/02	SK16R-P11	3353 1.1	-	IK16TT	IK16TT	6
3.0 i Bi-Turbo	243	2JZ-GTE		05/93-08/02	IK22	5310 0.8	-	-	VK22	6
TERCEL (79-88)										
1.3 (AL20, AL11)	48	2A		03/79-01/88	W16EXR-U	3031 0.8	W16TT	IW16TT	IW16TT	4
1.45 (AL21)	52	3A-C		08/83-05/85	W16EXR-U11	3032 1.1	W16TT	IW16TT	IW16TT	4
1.5 4WD	52	3A		10/82-01/88	W16EXR-U	3031 0.8	W16TT	IW16TT	IW16TT	4
1.5 4WD (AL25)	50	3A-C		05/86-01/88	W16EXR-U11	3032 1.1	W16TT	IW16TT	IW16TT	4
TERCEL (94-99)										
1.5	70	5E-FE		11/94-09/99	K16TR11	3194 1.1	K16TT	IK16TT	IK16TT	4
TOYOACE (79-85)										
	59	B	OE: 19850-54010	03/79-07/83	DG-211	11V				4
	59	B	Cold spec, OE: 19850-54020	03/79-07/83	DG-238	23V				4
TUNDRA (99-06)										
3.4	140	5VZ-FE		04/99-07/03	K16TR11	3194 1.1	K16TT	IK16TT	IK16TT	6
3.4 4WD	140	5VZ-FE		04/99-07/03	K16TR11	3194 1.1	K16TT	IK16TT	IK16TT	6
4.0	180	1GR-FE		05/03-11/06	K20HR-U11	3381 1.1	KH20TT	IKH20TT	IKH20TT	6
4.0 4WD	180	1GR-FE		05/03-11/06	K20HR-U11	3381 1.1	KH20TT	IKH20TT	IKH20TT	6
TUNDRA (07-)										
5.7	284	3UR-FE		01/07-	SK20HR11	3421 1.1	-	IKH20TT	IKH20TT	8
5.7 4WD	284	3UR-FE		01/07-	SK20HR11	3421 1.1	-	IKH20TT	IKH20TT	8







Spark & Glow Plugs

Application Tables







	KW				Standard 				Twin Tip 			QTY
TOYOTA continued												
URBAN CRUISER (07-)												
1.33	73/74	1NR-FE		11/13-	SC16HR11	3499	1.1	-	IXEH20TT	IXEH20TT		4
1.33	73/74	1NR-FE		04/09-11/13	SC20HR11	3444	1.1	-	IXEH22TT	IXEH22TT		4
1.4 D-4D	66	1ND-TV		04/09-10/10	DG-240		11V					4
1.4 D-4D 4WD	66	1ND-TV		04/09-10/10	DG-240		11V					4
1.5 VVTi	80	1NZ-FE		07/07-	K16R-U11	3120	1.1	K16TT	IK16TT	IK16TT		4
1.5 VVTi 4WD	76	1NZ-FE		04/09-	K16R-U11	3120	1.1	K16TT	IK16TT	IK16TT		4
VENZA (08-)												
2.7	136	1AR-FE		11/08-	SK16HR11	3417	1.1	-	IKH16TT	IKH16TT		4
2.7 4WD	136	1AR-FE		11/08-	SK16HR11	3417	1.1	-	IKH16TT	IKH16TT		4
3.5	200	2GR-FE		11/08-	FK20HR11	3426	1.1	-	IKH20TT	IKH20TT		6
3.5 4WD	200	2GR-FE		11/08-	FK20HR11	3426	1.1	-	IKH20TT	IKH20TT		6
VERSO (09-)												
1.6	97	1ZR-FAE		04/09-	SC20HR11	3444	1.1	-	IXEH22TT	IXEH22TT		4
1.8	108	2ZR-FAE		04/09-	SC20HR11	3444	1.1	-	IXEH22TT	IXEH22TT		4
2.0 D-4D	91/93	1AD-FTV		04/09-	DG-600		11V					4
2.2 D-4D	110	2AD-FHV		04/09-	DG-600		11V					4
2.2 D-CAT	130	2AD-FHV		04/09-	DG-600		11V					4
VERSO S (10-)												
1.33	70/73	1NR-FE		11/13-	SC16HR11	3499	1.1	-	IXEH20TT	IXEH20TT		4
1.33	70/73	1NR-FE		11/10-11/13	SC20HR11	3444	1.1	-	IXEH22TT	IXEH22TT		4
1.4 D4-D	66	1ND-TV		11/10-	DG-240		11V					4
1.5	80	1NZ-FE		11/10-	VFKH16	5654	1.1	-	IKH16TT	IKH16TT		4
1.5 4WD	76	1NZ-FE		11/10-	VFKH16	5654	1.1	-	IKH16TT	IKH16TT		4
VIOS / YARIS (07-)												
1.0	52	1KR-FE		08/07-02/12	K16HR-U11	3482	1.1	KH16TT	IKH16TT	IKH16TT		3
1.3	64	2NZ-FE; 2SZ-FE		08/07-	K16R-U11	3120	1.1	K16TT	IK16TT	IK16TT		4
1.3 4WD	64	2NZ-FE		08/07-	K16R-U11	3120	1.1	K16TT	IK16TT	IK16TT		4
1.5	80/81	1NZ-FE		08/07-	K16R-U11	3120	1.1	K16TT	IK16TT	IK16TT		4
VISTA (90-98)												
2.2	100	5S-FE		07/90-09/97	PK20TR11	3253	1.1	K20TT	IK20TT	IK20TT		4
VISTA (98-03)												
2.0 200G	107	3S-FSE		06/01-08/03	PK20GR8	3326	0.8	-	-	VKA20		4
3.0	140	1MZ-FE		06/98-08/02	K20TR11	3195	1.1	K20TT	IK20TT	IK20TT		6
3.0	140	1MZ-FE	OEM Optional	06/98-08/02	PK20TR11	3253	1.1	K20TT	IK20TT	IK20TT		6
WILL Cypha (01-05)												
1.5 VVTi 4WD	78	1NZ-FE		05/01-07/05	K16R-U11	3120	1.1	K16TT	IK16TT	IK16TT		4
WILL VS (01-04)												
1.5 VVTi 4WD	81	1NZ-FE		03/01-04/04	K16R-U11	3120	1.1	K16TT	IK16TT	IK16TT		4
WINDOM (96-01)												
2.2	96	5S-FE		10/96-07/01	PK20TR11	3253	1.1	K20TT	IK20TT	IK20TT		4
3.0	155	1MZ-FE		10/96-07/01	K20TR11	3195	1.1	K20TT	IK20TT	IK20TT		6
3.0	155	1MZ-FE	OEM Optional	10/96-07/01	PK20TR11	3253	1.1	K20TT	IK20TT	IK20TT		6
WINDOM (01-06)												
3.0 VVTi G	158	1MZ-FE		08/01-07/04	SK20R11	3297	1.1	-	IK20TT	IK20TT		6
WISH (03-09)												
1.8 Hi	97	1ZZ-FE		04/03-03/09	K16R-U11	3120	1.1	K16TT	IK16TT	IK16TT		4
1.8 Hi 4WD	92	1ZZ-FE		04/03-03/09	K16R-U11	3120	1.1	K16TT	IK16TT	IK16TT		4
2.0 Zi	114	1AZ-FSE		04/03-03/09	SK20BGR11	3472	1.1	-	-	VKA20		4
WISH (09-)												
1.8	106	2ZR-FAE		04/09-	SC20HR11	3444	1.1	-	IXEH22TT	IXEH22TT		4
1.8 4WD	98	2ZR-FAE		04/09-	SC20HR11	3444	1.1	-	IXEH22TT	IXEH22TT		4
2.0	116	3ZR-FAE		04/09-	SK20BGR11	3472	1.1	-	-	VKA20		4
2.0 4WD	116	3ZR-FAE		04/09-	SK20BGR11	3472	1.1	-	-	VKA20		4
YARIS (99-05)												
1.0 16V	48/50	1SZ-FE	FRP	01/01-09/05	K20R-U11	3139	1.1	K20TT	IK20TT	IK20TT		4
1.0 16V	50	1SZ-FE	JJP	04/99-12/02	K16R-U	3119	0.8	K16TT	IK16TT	IK16TT		4
1.3	64	2SZ-FE		04/02-09/05	K16R-U11	3120	1.1	K16TT	IK16TT	IK16TT		4
1.3 16V	63	2NZ-FE		11/99-09/05	K16R-U11	3120	1.1	K16TT	IK16TT	IK16TT		4
1.4 D-4D	55	1ND-TV		12/01-09/05	DG-240		11V					4
1.5 TS	77	1NZ-FE		01/03-09/05	K16R-U11	3120	1.1	K16TT	IK16TT	IK16TT		4
1.5 VVT-i TS	78/ 110	1NZ-FE	JJP	04/01-09/05	K16R-U11	3120	1.1	K16TT	IK16TT	IK16TT		4
YARIS (05-)												
1.0 GPL	51	1KR-FE	LPG / GPL	01/06-06/11	SK16HR11	3417	1.1	-	IKH16TT	IKH16TT		3
1.0 VVT-i	51	1KR-FE		08/05-06/11	K16HR-U11	3482	1.1	KH16TT	IKH16TT	IKH16TT		3
1.3 4WD	64	2NZ-FE; 2SZ-FE		08/07-	K16R-U11	3120	1.1	K16TT	IK16TT	IK16TT		4
1.3 VVT-i	63/64	2NZ-FE; 2SZ-FE		08/05-	K16R-U11	3120	1.1	K16TT	IK16TT	IK16TT		4







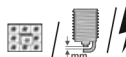



Spark & Glow Plugs







Application Tables

	KW					Standard			Twin Tip			QTY
TOYOTA <i>continued</i>												
YARIS (05-) <i>continued</i>												
1.33 VVT-i	73	1NR-FE		07/10-	SC20HR11	3444	1.1	-	IXEH22TT	IXEH22TT		4
1.33 VVT-i	74	1NR-FE	FRP	03/09-	SC20HR11	3444	1.1	-	IXEH22TT	IXEH22TT		4
1.4 D-4D	66	1ND-TV		08/05-11/08	DG-240		11V					4
1.5 (NCP91)	80	1NZ-FE		11/05-	K16R-U11	3120	1.1	K16TT	IK16TT	IK16TT		4
1.8 VTi	98	2ZR-FE		01/07-	SC20HR11	3444	1.1	-	IXEH22TT	IXEH22TT		4
YARIS (10-)												
1.0	51	1KR-FE		11/13-	SC16HR11	3499	1.1	-	IXEH20TT	IXEH20TT		3
1.0	51	1KR-FE		09/11-	SK16HR11	3417	1.1	-	IKH16TT	IKH16TT		3
1.3	70/73	1NR-FE; 1NR-FKE		11/13-	SC16HR11	3499	1.1	-	IXEH20TT	IXEH20TT		4
1.3	70/73	1NR-FE; 1NR-FKE		09/11-11/13	SC20HR11	3444	1.1	-	IXEH22TT	IXEH22TT		4
1.3 VVT-i	63	2NZ-FE		12/10-	K16R-U11	3120	1.1	K16TT	IK16TT	IK16TT		4
1.4 D-4D	66	1ND-TV		09/11-	DG-240		11V					4
1.5	80	1NZ-FE		12/10-	VFKH16	5654	1.1	-	IKH16TT	IKH16TT		4
1.5 Hybrid	55	1NZ-FXE		03/12-	FK16HR-A8		0.8	-	-	-	FK16HR-A8	4
YARIS VERSO (99-05)												
1.3 (NCP22)	62/63	2NZ-FE		08/99-09/05	K16R-U11	3120	1.1	K16TT	IK16TT	IK16TT		4
1.4 D-4D (NLP22)	55	1ND-TV		12/01-09/05	DG-240		11V					4
1.5 (NCP21)	77/78	1NZ-FE		03/00-09/05	K16R-U11	3120	1.1	K16TT	IK16TT	IK16TT		4
ZELAS (11-)												
2.5 VVT-i	131	2AR-FE		06/11-	SK16HR11	3417	1.1	-	IKH16TT	IKH16TT		4
TOYOTA (FAW)												
LAND CRUISER (07-)												
4.7	202	2UZ-FE		12/07-	SK20R11	3297	1.1	-	IK20TT	IK20TT		8
TOYOTA (GAC)												
HIGHLANDER (09-)												
3.5 4WD	201	2GR-FE		05/09-	FK20HR11	3426	1.1	-	IKH20TT	IKH20TT		6
TRABANT												
1.1 (90-91)												
1.1	30	4VO5;9 / 7;5GRF		05/90-12/91	W20EP-U	3043	0.8	W20TT	IW20TT	IW20TT		4
P 601 (66-90)												
0.6	19	P63/64		01/66-04/90	W22FS-U	4025	0.7	-	-	-		2
TRIUMPH												
2000 (68-77)												
2.0 TC	68	20TC		04/75-12/77	W16EPR-U	3021	0.8	W16TT	IW16TT	IW16TT		6
2500 (74-77)												
S	79			04/75-12/77	W16EPR-U	3021	0.8	W16TT	IW16TT	IW16TT		6
ACCLAIM (82-85)												
1.3 (XD)	51	EN		01/82-06/84	K20PR-U	3145	0.8	K20TT	IK20TT	IK20TT		4
SPITFIRE (62-80)												
1500	51	FM11		01/75-01/80	W16EPR-U	3021	0.8	W16TT	IW16TT	IW16TT		4
STAG (70-77)												
3.0	107			01/70-12/77	W16EPR-U	3021	0.8	W16TT	IW16TT	IW16TT		8
TVR												
280 (83-86)												
2.8 i	110			01/83-12/86	W22EPR-U	3088	0.8	W22TT	-	VW22		6
350 (83-89)												
3.5 i	145			01/83-12/89	W20EPR-U	3047	0.8	W20TT	IW20TT	IW20TT		8
390 (84-89)												
3.9	205			01/84-12/89	W22EPR-U	3088	0.8	W22TT	-	VW22		8
400 (89-93)												
3.9	200/ 202			01/89-12/93	W22ESR-U	3098	0.8	-	-	-		8
420 (85-89)												
4.2	224			01/85-12/89	W22EPR-U	3088	0.8	W22TT	-	VW22		8
450 (89-93)												
4.4	238			01/89-12/93	W22ESR-U	3098	0.8	-	-	-		8
CERBERA (96-03)												
4.0	268	P640		01/99-10/03	XU24EPR-U	3312	0.9	-	-	VXU24		6
4.2	257/ 265/ 268			01/96-10/03	K20TXR	5063	1.0	K20TT	IK20TT	IK20TT		8
4.5	313			01/97-10/03	K20TXR	5063	1.0	K20TT	IK20TT	IK20TT		8
4.5 GT	324			01/96-10/03	K20TXR	5063	1.0	K20TT	IK20TT	IK20TT		8
CHIMAERA (92-03)												
4.0	177	39SE		01/93-10/03	W22ESR-U	3098	0.8	-	-	-		8
4.3	206			01/93-12/93	W22ESR-U	3098	0.8	-	-	-		8

KW	KW	KW	KW	KW	KW	Standard			Twin Tip			QTY
						Standard	Standard	Standard	Twin Tip	Twin Tip	Twin Tip	
TVR continued												
CHIMAERA (92-03) continued												
5.0	217/235/243/250	J8T		11/92-10/03	W22ESR-U	3098	0.8	-	-	-	-	8
GRIFFITH (90-02)												
4.0	177			01/90-12/93	W22ESR-U	3098	0.8	-	-	-	-	8
4.3	206			01/90-12/93	W22ESR-U	3098	0.8	-	-	-	-	8
5.0	217/235/243/250/254	J8T		10/92-09/97	W22ESR-U	3098	0.8	-	-	-	-	8
S (86-96)												
2.9	125			01/88-12/96	T20EPR-U	5032	0.8	T20TT	IT20TT	IT20TT	-	6
SPEED EIGHT (89-92)												
4.0	168			01/89-12/92	W22ESR-U	3098	0.8	-	-	-	-	8
4.3	198			01/89-12/91	W22ESR-U	3098	0.8	-	-	-	-	8
UAZ												
3160 (94-)												
2.4 i	76	UMZ 4178.10		01/94-	W16FPR-U	4192	0.7	-	-	-	-	4
2.9	76			08/97-	W20FPR-U	3070	0.7	WF20TT	-	-	-	4
2.9 i	88			08/97-	W20FPR-U	3070	0.7	WF20TT	-	-	-	4
3162 (97-)												
2.9 i	88			08/97-	W20FPR-U	3070	0.7	WF20TT	-	-	-	4
31512 (98-)												
2.1 D	61	XUD11 A		01/98-	DG-001		11V					4
4.3 V6	135			01/98-	W16FS-U	3034	0.7	-	-	-	-	6
HUNTER (04-)												
2.7	94	ZMZ-409.10		07/04-	K16PR-U	3191	0.8	K16TT	IK16TT	IK16TT	-	4
PATRIOT (04-)												
2.7	82/94	ZMZ-409.10		07/04-	K16PR-U	3191	0.8	K16TT	IK16TT	IK16TT	-	4
UAS (66-)												
2.4	52/59	UMZ 451M		08/66-	W16FPR-U	4192	0.7	-	-	-	-	4
VAUXHALL												
ADAM (12-)												
1.2	51	A 12 XEL		10/12-	KJ20CR-L11	3169	1.1	K20TT	IK20TT	IK20TT	-	4
1.4	64/74	A 14 XEL; A 14 XER		10/12-	KJ20CR-L11	3169	1.1	K20TT	IK20TT	IK20TT	-	4
1.4 LPG	64	A 14 XEL		07/13-	VK20T	5501	0.8	-	IK20TT	IK20TT	-	4
AGILA I (A) (00-08)												
1.0 12V	43/44	Z 10 XE; Z 10 XEP		02/00-11/06	K20TXR	5063	1.0	K20TT	IK20TT	IK20TT	-	3
1.2 16V	55	Z 12 XE		09/00-03/08	K20TXR	5063	1.0	K20TT	IK20TT	IK20TT	-	4
1.2 16V Twinport	59	Z 12 XEP		07/04-11/06	KJ16CR-L11	3132	1.1	K16TT	IK16TT	IK16TT	-	4
1.3 CDTI	51	Z 13 DT		08/03-03/08	DG-171		11V					4
AGILA II (B) (08-)												
1.0 12V	48	K10B		01/08-	ZXU20PR11	3452	1.1	-	-	VXU22	-	3
1.0 i	50	K10B		08/11-	ZXU20PR11	3452	1.1	-	-	VXU22	-	3
1.0 LPG	48	K10B		01/08-	ZXU20PR11	3452	1.1	-	-	VXU22	-	3
1.2	58			05/09-	ZXU20PR11	3452	1.1	-	-	VXU22	-	4
1.2 i 16V	63/69	K12B		01/08-	ZXU20PR11	3452	1.1	-	-	VXU22	-	4
1.2 LPG	63	K12B		04/08-	ZXU20PR11	3452	1.1	-	-	VXU22	-	4
1.3 CDTI	55	Z 13 DTJ		01/08-	DG-171		11V					4
ANTARA (06-)												
2.0 CDTI	93/110	Z 20 DMH		08/06-	DG-604		4.4V					4
2.4	123/126	A24XE		11/10-	ITL16	5349	1.1	-	ITL16TT	ITL16TT	-	4
2.4	103	Z 24 XED		08/06-	K20TXR	5063	1.0	K20TT	IK20TT	IK20TT	-	4
2.4 FWD	103	Z 24 XED		08/06-	K20TXR	5063	1.0	K20TT	IK20TT	IK20TT	-	4
3.0	188	A 30 XH		11/10-	ITV20	5339	1.1	-	ITV20TT	ITV20TT	-	6
3.2 V6	167	Z32SE(227)		11/06-	PT16VR13	5068	1.3	TV16TT	ITV16TT	ITV16TT	-	6
ARENA (98-01)												
1.9 D	44	F8Q 600; F8Q 606		03/98-08/01	DG-008		11V					4
2.5 D	55	S8U 758; S8U 780; S8U 782		03/98-08/01	DG-004		11.5V					4
ASTRA I (79-86)												
1.2 S	44	12S		02/82-08/84	W20FPR-U	3070	0.7	WF20TT	-	-	-	4
1.3 S	55	13S		09/79-08/84	W20EPR-U	3047	0.8	W20TT	IW20TT	IW20TT	-	4
1.6 D	40	16 D		02/82-08/86	DG-001		11V					4
1.6 S	66	16S;16SH; 16S		09/81-10/84	W20EPR-U	3047	0.8	W20TT	IW20TT	IW20TT	-	4
1.8 GTE	85	18E		03/83-10/84	W20EPR-U	3047	0.8	W20TT	IW20TT	IW20TT	-	4



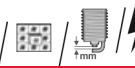



	KW								QTY		
VAUXHALL <i>continued</i>											
ASTRA II (84-94)											
1.2	44	12ST		09/84-08/91	W20EPR-U	3047	0.8	W20TT	IW20TT	IW20TT	4
1.2	44	12S		09/84-12/88	W20FPR-U	3070	0.7	WF20TT	-	-	4
1.3	44/51/55	13NB;C13N; 13S		09/84-08/91	W20EPR-U	3047	0.8	W20TT	IW20TT	IW20TT	4
1.4 i	44	C14NZ		01/90-12/91	W20EPR-U	3047	0.8	W20TT	IW20TT	IW20TT	4
1.4 S	55	14NV		01/89-08/91	W20EPR-U	3047	0.8	W20TT	IW20TT	IW20TT	4
1.5 DT	49/53	15 DT (T4EC1)	Eng: >817252	01/87-08/90	DG-159		5V				4
1.5 DT	49/53	15 DT (T4EC1)	Eng: 817253>	01/87-08/90	DG-104		11V				4
1.6	60	16SV		09/84-08/86	W20EPR-U	3047	0.8	W20TT	IW20TT	IW20TT	4
1.6 D	40	16 DA		09/84-08/91	DG-001		11V				4
1.6 i	60	16SV		01/87-12/91	W20EPR-U	3047	0.8	W20TT	IW20TT	IW20TT	4
1.6 i CAT	55	C16NZ		10/87-10/91	W20EPR-U	3047	0.8	W20TT	IW20TT	IW20TT	4
1.6 S	60/66	16S-OHC; 16SV		09/84-12/91	W20EPR-U	3047	0.8	W20TT	IW20TT	IW20TT	4
1.7 D	42	17 D; 17 DR		01/89-12/91	DG-001		11V				4
1.8	82	18SE		01/86-12/90	W20EPR-U	3047	0.8	W20TT	IW20TT	IW20TT	4
1.8 GTE	82	18SE		09/84-08/91	W20EPR-U	3047	0.8	W20TT	IW20TT	IW20TT	4
1.8 i	83	18SE		01/90-08/91	W20EPR-U	3047	0.8	W20TT	IW20TT	IW20TT	4
2.0 GTE	95	20SEH		09/86-08/91	W20EPR-U	3047	0.8	W20TT	IW20TT	IW20TT	4
2.0 GTE 16V	115	C20XE		05/88-08/91	K20PR-U	3145	0.8	K20TT	IK20TT	IK20TT	4
ASTRA III (F) (91-01)											
1.4	55	14 NV		09/91-09/93	K20TXR	5063	1.0	K20TT	IK20TT	IK20TT	4
1.4 i	44/60	C 14 NZ; C 14 SE		04/92-03/01	K20TXR	5063	1.0	K20TT	IK20TT	IK20TT	4
1.4 i	44	C 14 NZ	Ch: >02BF1476	01/91-10/94	W20EPR-U	3047	0.8	W20TT	IW20TT	IW20TT	4
1.4 i	44	C 14 NZ	Ch: 02BF1477>	01/91-10/94	K20TXR	5063	1.0	K20TT	IK20TT	IK20TT	4
1.4 i 16V	66	X 14 XE		01/96-03/01	K20TXR	5063	1.0	K20TT	IK20TT	IK20TT	4
1.4 S	55	14 NV		09/91-02/98	K20TXR	5063	1.0	K20TT	IK20TT	IK20TT	4
1.6	74	C 16 SE		03/94-08/95	K20TXR	5063	1.0	K20TT	IK20TT	IK20TT	4
1.6 i	52/55/74	C 16 NZ; C 16 SE; E 16 NZ; X 16 SZ; X 16 SZR		05/92-08/96	K20TXR	5063	1.0	K20TT	IK20TT	IK20TT	4
1.6 i	52/55	C 16 NZ; X 16 SZ	Ch: >02BF1476	01/91-08/98	W20EPR-U	3047	0.8	W20TT	IW20TT	IW20TT	4
1.6 i	52/55	C 16 NZ; X 16 SZ	Ch: 02BF1477>	01/91-08/98	K20TXR	5063	1.0	K20TT	IK20TT	IK20TT	4
1.6 i 16V	74	X 16 XEL		01/94-09/98	K20TXR	5063	1.0	K20TT	IK20TT	IK20TT	4
1.6 Si	74	C 16 SE		03/91-12/94	K20TXR	5063	1.0	K20TT	IK20TT	IK20TT	4
1.7 D	42/44	17 D; 17 DR		09/91-12/94	DG-001		11V				4
1.7 TD	50	X 17 DTL		01/94-09/98	DG-001		11V				4
1.7 TD	60	17 DT (TC4EE1)	Eng: >956632	12/91-09/98	DG-104		11V				4
1.7 TD	60	17 DT (TC4EE1)	Eng: 956633>	12/91-09/98	DG-300		11V				4
1.8	92	C 18 XE		09/94-08/96	K20TXR	5063	1.0	K20TT	IK20TT	IK20TT	4
1.8 16V	85	C 18 XEL; X 18 XE		11/94-03/01	K20TXR	5063	1.0	K20TT	IK20TT	IK20TT	4
1.8 i	66	C 18 NZ		09/91-09/98	K20TXR	5063	1.0	K20TT	IK20TT	IK20TT	4
1.8 i 16V	82/85/92	18 SE; C 18 XEL; X 18 XE		09/94-02/98	K20TXR	5063	1.0	K20TT	IK20TT	IK20TT	4
2.0 i	85	C 20 NE		09/91-09/98	K20TXR	5063	1.0	K20TT	IK20TT	IK20TT	4
2.0 i 16V	100/110	C 20 XE; X 20 XEV		09/91-02/98	K20TXR	5063	1.0	K20TT	IK20TT	IK20TT	4
ASTRA IV (G) (98-06)											
1.2 16V	48/55	X 12 XE; Z 12 XE		02/98-05/05	K20TXR	5063	1.0	K20TT	IK20TT	IK20TT	4
1.4	44	C 14 NZ		05/98-05/05	K20TXR	5063	1.0	K20TT	IK20TT	IK20TT	4
1.4	44	C 14 NZ; X 14 SZ	Check Hex size	05/98-05/05	K20TXR	5063	1.0	K20TT	IK20TT	IK20TT	4
1.4 16V	66	X 14 XE; Z 14 XE	Ch: >42000000, 45000000, 48000000, 4B000000	02/98-05/05	K20TXR	5063	1.0	K20TT	IK20TT	IK20TT	4
1.4 16V	66	X 14 XE; Z 14 XE	Ch: 42000001, 45000001, 46000001, 48000001, 4B000001>	02/98-05/05	KJ16CR-L11	3132	1.1	K16TT	IK16TT	IK16TT	4
1.6	76	Z 16 XEP	Ch: 42000001, 45000001, 46000001, 48000001, 4B000001>	12/02-05/05	KJ16CR-L11	3132	1.1	K16TT	IK16TT	IK16TT	4







	KW										QTY
VAUXHALL <i>continued</i>											
ASTRA IV (G) (98-06) <i>continued</i>											
1.6	55/62	X 16 SZR; Z 16 SE		02/98-05/05	K20TXR	5063	1.0	K20TT	IK20TT	IK20TT	4
1.6	76	Z 16 XEP	Ch: >42000000, 45000000, 48000000, 4B000000	12/02-05/05	K20TXR	5063	1.0	K20TT	IK20TT	IK20TT	4
1.6 16V	74	C 16 SEL; X 16 XEL; Z 16 XE; Z 16 XEP		03/98-05/05	K20TXR	5063	1.0	K20TT	IK20TT	IK20TT	4
1.6 16V	74/76	Z 16 XE; Z 16 XEP	Ch: >42000000, 45000000, 48000000, 4B000000	03/01-10/05	K20TXR	5063	1.0	K20TT	IK20TT	IK20TT	4
1.6 16V	74/76	Z 16 XE; Z 16 XEP	Ch: 42000001, 45000001, 46000001, 48000001, 4B000001>	03/01-10/05	KJ16CR-L11	3132	1.1	K16TT	IK16TT	IK16TT	4
1.6 Dualfuel	62/63	Z 16 SE; Z 16 XE		07/00-05/05	K20TXR	5063	1.0	K20TT	IK20TT	IK20TT	4
1.6 i	55/62	X 16 SZR; Z 16 SE	Ch: >42000000, 45000000, 48000000, 4B000000	08/98-08/06	K20TXR	5063	1.0	K20TT	IK20TT	IK20TT	4
1.6 i	55/62	X 16 SZR; Z 16 SE	Ch: 42000001, 45000001, 46000001, 48000001, 4B000001>	08/98-08/06	KJ16CR-L11	3132	1.1	K16TT	IK16TT	IK16TT	4
1.7 CDTI	59	Z 17 DTL		04/04-08/06	DG-302		11V				4
1.7 CDTI 16V	59	Z 17 DTL		04/03-05/05	DG-302		11V				4
1.7 DTI 16V	55	Y 17 DT		02/00-08/06	DG-302		11V				4
1.7 TD	50	X 17 DTL		02/98-08/00	DG-001		11V				4
1.8 16V	85/92	X 18 XE1; Z 18 XEL		02/98-08/05	K20TXR	5063	1.0	K20TT	IK20TT	IK20TT	4
1.8 16V Dualfuel	87	Z 18 XE		02/98-08/05	K20TXR	5063	1.0	K20TT	IK20TT	IK20TT	4
2.0	118/ 147	X 20 XER; Z 20 LET		10/99-10/05	K20TXR	5063	1.0	K20TT	IK20TT	IK20TT	4
2.0 16V	100/ 118	X 20 XER; X 20 XEV		02/98-05/05	K20TXR	5063	1.0	K20TT	IK20TT	IK20TT	4
2.0 16V Turbo	140	Z 20 LET		09/00-08/05	K20TXR	5063	1.0	K20TT	IK20TT	IK20TT	4
2.0 DI	60	X 20 DTL; Y 20 DTL		03/98-08/06	DG-118		11V				4
2.0 DTI	74	Y 20 DTH		04/04-08/06	DG-118		11V				4
2.0 DTI 16V	74	Y 20 DTH		02/98-08/02	DG-118		11V				4
2.0 DTI 16V	74	Y 20 DTH		09/02-07/04	DG-142		11V				4
2.0 SRI Turbo	141	Z 20 LET		07/02-05/05	K20TXR	5063	1.0	K20TT	IK20TT	IK20TT	4
2.0 Turbo	141	Z 20 LET		03/02-10/05	K20TXR	5063	1.0	K20TT	IK20TT	IK20TT	4
2.2 16V	108	Z 22 SE		03/00-10/05	PT16VR13	5068	1.3	TV16TT	ITV16TT	ITV16TT	4
2.2 DTI	92	Y 22 DTR		09/02-05/05	DG-142		11V				4
ASTRA V (H) (04-10)											
1.2	59	Z 12 XEP		08/05-10/10	KJ16CR-L11	3132	1.1	K16TT	IK16TT	IK16TT	4
1.3 CDTI	66	Z 13 DTH		01/04-12/10	DG-171		11V				4
1.4	66	Z 14 XEP		01/04-05/09	KJ16CR-L11	3132	1.1	K16TT	IK16TT	IK16TT	4
1.4 i	66	Z 14 XEP		03/05-	KJ16CR-L11	3132	1.1	K16TT	IK16TT	IK16TT	4
1.4 i 16V	66	Z 14 XEP		03/05-11/10	KJ16CR-L11	3132	1.1	K16TT	IK16TT	IK16TT	4
1.6	85/ 132	Z 16 XER; Z16LET(180)		01/04-05/09	KJ16CR-L11	3132	1.1	K16TT	IK16TT	IK16TT	4
1.6	76/77	Z 16 XE1; Z 16 XEP		03/05-	KJ20CR-L11	3169	1.1	K20TT	IK20TT	IK20TT	4
1.6	77	Z 16 XEP	Ch: >42000000, 45000000, 48000000, 4B000000	01/04-05/09	K20TXR	5063	1.0	K20TT	IK20TT	IK20TT	4
1.6	85	A 16 XER; Z 16 XER	Ch: >92999999; 95999999; 98999999; 9G999999; 9B999999	08/04-03/09	KJ16CR-L11	3132	1.1	K16TT	IK16TT	IK16TT	4
1.6	77	Z 16 XEP	Ch: 42000001, 45000001, 46000001, 48000001, 4B000001>	01/04-05/09	KJ16CR-L11	3132	1.1	K16TT	IK16TT	IK16TT	4
1.6	85	A 16 XER; Z 16 XER	Ch: A2000001; A8000001; AG000001>	08/04-03/09	KJ20CR-L11	3169	1.1	K20TT	IK20TT	IK20TT	4



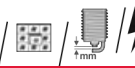

	KW								QTY		
VAUXHALL <i>continued</i>											
ASTRA V (H) (04-10) <i>continued</i>											
1.6 i 16V	85	Z 16 XER	Ch: >92999999; 95999999; 98999999; 9G999999; 9B999999	10/06-11/10	KJ16CR-L11	3132	1.1	K16TT	IK16TT	IK16TT	4
1.6 i 16V	85	Z 16 XER	Ch: A2000001; A8000001; AG000001>	10/06-11/10	KJ20CR-L11	3169	1.1	K20TT	IK20TT	IK20TT	4
1.7 CDTi	59/ 74/ 81/ 92	A 17 DTJ; A 17 DTR; Z 17 DTH; Z 17 DTJ; Z 17 DTL; Z 17 DTR		01/04-	DG-302		11V				4
1.7 TD	79			01/04-05/09	DG-302		11V				4
1.8	92	Z 18 XE		01/04-05/09	KJ16CR-L11	3132	1.1	K16TT	IK16TT	IK16TT	4
1.8	103	A 18 XER; Z 18 XER	Ch: >D2999999; D5999999; D8999999; DG999999; 9B999999	01/04-11/10	KJ16CR-L11	3132	1.1	K16TT	IK16TT	IK16TT	4
1.8	103	A 18 XER; Z 18 XER	Ch: E2000001; E8000001; EG000001>	01/04-11/10	KJ20CR-L11	3169	1.1	K20TT	IK20TT	IK20TT	4
1.8 i 16V	103	A 18 XER; Z 18 XER	Ch: >D2999999; D5999999; D8999999; DG999999; 9B999999	03/07-11/10	KJ16CR-L11	3132	1.1	K16TT	IK16TT	IK16TT	4
1.8 i 16V	103	A 18 XER; Z 18 XER	Ch: E2000001; E8000001; EG000001>	03/07-11/10	KJ20CR-L11	3169	1.1	K20TT	IK20TT	IK20TT	4
1.9 CDTi	74/88	Z 19 DTL	Ch: >72045139;750 30986;7800739 1	08/04-03/09	DG-122		11V				4
1.9 CDTi	88	Z 19 DT; Z 19 DTJ	Ch: 72045140: 75030987;7800 7392>	01/04-05/09	DG-196		11V				4
1.9 CDTi	74/88	Z 19 DTL	Ch: 72045140:7503 0987;78007392 >	08/04-03/09	DG-196		11V				4
1.9 CDTi	110	Z 19 DTH		01/04-05/09	DG-170		11V				4
1.9 CDTi	88	Z 19 DTJ	Eng: >72045139;750 30986;7800739 1	08/04-03/09	DG-122		11V				4
1.9 CDTi 16V	88	Z 19 DTJ		01/04-05/09	DG-170		11V				4
2.0	125	Z 20 LEL		02/06-11/10	KJ16CR-L11	3132	1.1	K16TT	IK16TT	IK16TT	4
2.0 Turbo	125/ 147	Z 20 LEL; Z 20 LER		01/04-10/10	KJ16CR-L11	3132	1.1	K16TT	IK16TT	IK16TT	4
2.0 Turbo	177	Z 20 LEH		01/04-05/09	PK20PR-P8	3245	0.8	-	IK20TT	IK20TT	4
2.0 VXR	176	Z 20 LEH		02/09-11/10	PK20PR-P8	3245	0.8	-	IK20TT	IK20TT	4
ASTRA VI (J) (09-)											
1.3 CDTi	70	A 13 DTE	Ch: CG000001;C80 00001;C30000 01;C1000001; C0000001;>	12/09-	DG-621		4.4V				4
1.3 CDTi	70	A 13 DTE	2-3 Cylinders(+), Ch: >BG999999;B8 999999;B3999 999	12/09-	DG-621		4.4V				4
1.4	64/74	A 14 XEL; A 14 XER		12/09-	KJ20CR-L11	3169	1.1	K20TT	IK20TT	IK20TT	4
1.6	85	A 16 XER		12/09-	KJ20CR-L11	3169	1.1	K20TT	IK20TT	IK20TT	4
1.6 Turbo	132	A 16 LET		12/09-	IK20L	5358	1.1	-	IK20TT	IK20TT	4
1.7 CDTi	81/92	A 17 DTJ; A 17 DTR		12/09-	DG-302		11V				4
2.0 BiTurbo CDTi	143	A 20 DTR	Ch: >BG999999	12/12-	DG-608		4.4V				4
2.0 BiTurbo CDTi	143	A 20 DTR	Ch: >BG999999;B3 999999;B8999 999	12/12-	DG-608		4.4V				4
2.0 CDTi	118/ 121	A 20 DTH	Ch: >BG999999;B3 999999;B8999 999	10/10-	DG-608		4.4V				4

Spark & Glow Plugs

Application Tables







	KW				Standard 			Twin Tip 			QTY
VAUXHALL continued											
BRAVA (88-02)											
2.2 D (TFR52)	39	C223		12/88-09/96	DG-124		11V				4
2.2 D 4x4 (TFS52)	39	C223		12/88-09/96	DG-124		11V				4
2.3 (TFR16)	69/72	4ZDI		08/91-09/96	W20EPR-U	3047	0.8	W20TT	IW20TT	IW20TT	4
2.3 4x4 (TFS16)	69/72	4ZDI		06/90-09/96	W20EPR-U	3047	0.8	W20TT	IW20TT	IW20TT	4
2.5 D (TFR54)	56	4 JA1		08/91-06/94	DG-108		11V				4
2.5 D 4x4 (TFS54)	56	4 JA1T		06/90-06/94	DG-108		11V				4
2.5 DTI	74	4 JA1		08/01-12/02	DG-108		11V				4
2.5 DTI 4x4	74	4 JA1		08/01-12/02	DG-108		11V				4
2.5 TD (TFR54)	56	4 JA1T		07/94-12/02	DG-108		11V				4
2.5 TD 4x4 (TFS54)	56	4 JA1T		07/94-12/02	DG-108		11V				4
3.1 D	80	4 JG2 T		07/91-07/01	DG-104		11V				4
CALIBRA (90-97)											
2.0 i	85	C 20 NE		07/93-07/97	K20TXR	5063	1.0	K20TT	IK20TT	IK20TT	4
2.0 i	85	C 20 NE		06/90-06/93	W16EPR-U	3021	0.8	W16TT	IW16TT	IW16TT	4
2.0 i 16V	100/110	C 20 XE; X 20 XEV		06/90-07/97	K20TXR	5063	1.0	K20TT	IK20TT	IK20TT	4
2.0 i 16V 4x4	100/110	C 20 XE; X 20 XEV		06/90-07/97	K20TXR	5063	1.0	K20TT	IK20TT	IK20TT	4
2.0 i 4x4	85	C 20 NE		07/93-07/97	K20TXR	5063	1.0	K20TT	IK20TT	IK20TT	4
2.0 i 4x4	85	C 20 NE		06/90-06/93	W16EPR-U	3021	0.8	W16TT	IW16TT	IW16TT	4
2.0 i Turbo 4x4	150	C 20 LET		03/92-07/97	KJ20CR-U11	3451	1.1	K20TT	IK20TT	IK20TT	4
2.5 i V6	125	C 25 XE; X 25 XE		04/93-07/97	K20TXR	5063	1.0	K20TT	IK20TT	IK20TT	6
CARLTON II (77-86)											
1.8 S	65/66	18S		11/82-08/86	W20EPR-U	3047	0.8	W20TT	IW20TT	IW20TT	4
2.0 i	81	20E		01/83-12/84	W20EPR-U	3047	0.8	W20TT	IW20TT	IW20TT	4
2.0 S	74	20S		10/78-08/86	W20EPR-U	3047	0.8	W20TT	IW20TT	IW20TT	4
2.2 i	85	22E		11/84-08/86	W20EPR-U	3047	0.8	W20TT	IW20TT	IW20TT	4
2.3 D	52	23 D		05/83-08/86	DG-001		11V				4
CARLTON III (86-94)											
1.8	65	E18NVR		09/87-03/94	W20EPR-U	3047	0.8	W20TT	IW20TT	IW20TT	4
1.8 i	85	18SEH		09/86-08/92	W20EPR-U	3047	0.8	W20TT	IW20TT	IW20TT	4
1.8 N	60	18NV		09/86-08/87	W20EPR-U	3047	0.8	W20TT	IW20TT	IW20TT	4
1.8 S	66	18SV		09/86-09/90	W20EPR-U	3047	0.8	W20TT	IW20TT	IW20TT	4
2.0	73	C 20 NEJ		09/90-03/94	K20TXR	5063	1.0	K20TT	IK20TT	IK20TT	4
2.0	74	C20NE(100)		09/90-03/94	W16EPR-U	3021	0.8	W16TT	IW16TT	IW16TT	4
2.0	85	C 20 NE	Ch: R1000001, R5000001, P7000001>	09/86-03/94	K20TXR	5063	1.0	K20TT	IK20TT	IK20TT	4
2.0 i	73	C 20 NEJ		09/90-03/94	K20TXR	5063	1.0	K20TT	IK20TT	IK20TT	4
2.0 i	90	20 SE		09/86-03/94	W20EPR-U	3047	0.8	W20TT	IW20TT	IW20TT	4
2.2 TD	66	23 YDT		09/86-08/88	DG-001		11V				4
2.3 D	54	23 YD		09/86-03/94	DG-001		11V				4
2.3 TD Interc.	74	23 DTR		08/88-03/94	DG-001		11V				4
2.4 i	92	C24NE		09/88-03/94	K20TXR	5063	1.0	K20TT	IK20TT	IK20TT	4
2.6 i	110	C26NE		09/90-03/94	W20FPR-U	3070	0.7	WF20TT	-	-	6
3.0	130	30NE		10/89-09/90	W20FPR-U	3070	0.7	WF20TT	-	-	6
3.0 24V	147	C30SEJ		09/89-03/94	K20TXR	5063	1.0	K20TT	IK20TT	IK20TT	6
3.0 3000	130	30NE		03/87-09/90	W20FPR-U	3070	0.7	WF20TT	-	-	6
3.0 3000 24V	150	C30SE		09/89-03/94	K20TXR	5063	1.0	K20TT	IK20TT	IK20TT	6
3000	115	C30LE		03/87-12/87	K20TXR	5063	1.0	K20TT	IK20TT	IK20TT	6
3000 24V	147	C30SEJ		09/89-03/94	K20TXR	5063	1.0	K20TT	IK20TT	IK20TT	6
3000 CAT	130	C30NE		03/88-03/94	K20TXR	5063	1.0	K20TT	IK20TT	IK20TT	6
CAVALIER I (75-81)											
1.6 S	55	16SOHV	Ch: 634748>	08/75-08/81	W20FPR-U	3070	0.7	WF20TT	-	-	4
1.9 S	66	19 S		10/75-03/78	W20FPR-U	3070	0.7	WF20TT	-	-	4
2.0 S	74	20S	Ch: 436257>	01/78-08/81	W20FPR-U	3070	0.7	WF20TT	-	-	4
1300	44	13SOHV		08/77-08/81	W20EPR-U	3047	0.8	W20TT	IW20TT	IW20TT	4
1900	66	19 S		10/75-03/78	W20FPR-U	3070	0.7	WF20TT	-	-	4
1900	66	19S	Ch: 1603327>	10/75-03/78	W20FPR-U	3070	0.7	WF20TT	-	-	4
CAVALIER II (81-88)											
1.3 S	55	13 S		09/81-08/88	W20EPR-U	3047	0.8	W20TT	IW20TT	IW20TT	4
1.6	66	16 SH		10/83-08/88	W20EPR-U	3047	0.8	W20TT	IW20TT	IW20TT	4
1.6 D	40	16 D; 16 DA		03/82-08/88	DG-001		11V				4
1.6 S	66	16 SH		09/81-08/88	W20EPR-U	3047	0.8	W20TT	IW20TT	IW20TT	4
1.8 i	82/85	18 E; 18 SE		09/81-08/88	W20EPR-U	3047	0.8	W20TT	IW20TT	IW20TT	4
2.0 i	85	20 NE		09/86-08/88	IW20	5306	1.1	-	IW20TT	IW20TT	4

	KW								QTY		
VAUXHALL <i>continued</i>											
CAVALIER II (81-88) <i>continued</i>											
2.0 i CAT	85	C 20 NE		09/86-08/88	W16EPR-U	3021	0.8	W16TT	IW16TT	IW16TT	4
2.0 SRi 130	95	20 SEH		03/87-08/88	W20EPR-U	3047	0.8	W20TT	IW20TT	IW20TT	4
1600D	40	16 D; 16 DA		03/82-08/88	DG-001		11V				4
1800i	82	18 SE		03/85-10/88	W20EPR-U	3047	0.8	W20TT	IW20TT	IW20TT	4
CAVALIER III (88-95)											
1.4 S	55	14 NV		09/88-11/95	W20EPR-U	3047	0.8	W20TT	IW20TT	IW20TT	4
1.6	60	16 SV		09/88-05/93	W20EPR-U	3047	0.8	W20TT	IW20TT	IW20TT	4
1.6 i	52/55	E 16 NZ; X 16 SZ		09/88-11/95	IW20	5306	1.1	-	IW20TT	IW20TT	4
1.7 D	42/44	17 D; 17 DR		09/88-11/95	DG-001		11V				4
1.7 TD	60	17 DT (TC4EE1)	Eng: >731417	09/88-11/95	DG-124		11V				4
1.7 TD	60	17 DT (TC4EE1)	Eng: 731418>	09/88-11/95	DG-300		11V				4
1.8	66	18 SV		09/88-08/95	W20EPR-U	3047	0.8	W20TT	IW20TT	IW20TT	4
1.8 i CAT	66	C 18 NZ		03/90-11/95	W16EPR-U	3021	0.8	W16TT	IW16TT	IW16TT	4
2.0 i	85	20 NE		09/88-10/92	IW20	5306	1.1	-	IW20TT	IW20TT	4
2.0 i 16V	100/110	C 20 XE; X 20 XEV		09/88-11/95	K20TXR	5063	1.0	K20TT	IK20TT	IK20TT	4
2.0 i 16V 4x4	110	C 20 XE		09/88-11/95	K20TXR	5063	1.0	K20TT	IK20TT	IK20TT	4
2.0 i 4x4	85	20 NE		01/91-10/92	K20TXR	5063	1.0	K20TT	IK20TT	IK20TT	4
2.0 i 4x4	85	20 NE		01/91-10/92	W16EPR-U	3021	0.8	W16TT	IW16TT	IW16TT	4
2.0 i 4x4	95	20 SEH		09/88-09/92	W20EPR-U	3047	0.8	W20TT	IW20TT	IW20TT	4
2.0 i CAT	85	C 20 NE		09/90-11/95	IW20	5306	1.1	-	IW20TT	IW20TT	4
2.0 i CAT	85	C 20 NE		09/90-11/95	K20TXR	5063	1.0	K20TT	IK20TT	IK20TT	4
2.0 i Turbo 4x4	150	C 20 LET		06/92-11/94	K20R-U	3122	0.8	K20TT	IK20TT	IK20TT	4
2.0 SRi	95	20 SEH		09/88-09/92	W20EPR-U	3047	0.8	W20TT	IW20TT	IW20TT	4
2.0 SRi 16V	100	X 20 XEV		09/93-11/95	K20TXR	5063	1.0	K20TT	IK20TT	IK20TT	4
2.5 V6	125	C 25 XE		08/88-06/94	K20TXR	5063	1.0	K20TT	IK20TT	IK20TT	6
CHEVETTE (75-85)											
1300	42	13SOHV		09/76-12/85	W20EPR-U	3047	0.8	W20TT	IW20TT	IW20TT	4
COMBO I (B) (94-01)											
1.4	44/60	C 14 NZ; C 14 SE		07/94-10/01	K20TXR	5063	1.0	K20TT	IK20TT	IK20TT	4
1.4 16V	66	X 14 XE		08/99-10/01	K20TXR	5063	1.0	K20TT	IK20TT	IK20TT	4
1.7 D	44	17 D (4EE1); X 17 D (4EE1)		07/94-10/01	DG-300		11V				4
COMBO II (C) (01-12)											
1.3 CDTi 16V	51/55	Z 13 DT; Z 13 DTJ		09/04-02/12	DG-171		11V				4
1.4	66	Z 14 XEP		10/04-09/10	KJ16CR-L11	3132	1.1	K16TT	IK16TT	IK16TT	4
1.4 16V	66	Z 14 XE		10/01-05/07	KJ16CR-L11	3132	1.1	K16TT	IK16TT	IK16TT	4
1.4 i 16V	66	Z 14 XEP		01/04-11/11	KJ16CR-L11	3132	1.1	K16TT	IK16TT	IK16TT	4
1.6	62/64	Z 16 SE		09/01-11/11	K20TXR	5063	1.0	K20TT	IK20TT	IK20TT	4
1.6 CNG 16V	69/71	Z 16 YNG	LPG / GPL	04/05-02/12	PK20PR-P8	3245	0.8	-	IK20TT	IK20TT	4
1.7 CDTi 16V	74	Z 17 DTH		12/04-11/11	DG-302		11V				4
1.7 DI 16V	48	Y 17 DTL		09/01-11/11	DG-302		11V				4
1.7 DTi 16V	55	Y 17 DT		10/01-02/12	DG-302		11V				4
COMBO III (D) (11-)											
1.3 CDTi	66	A 13 FD		11/11-	DG-621		4.4V				4
1.6 CDTi	66/77	A 16 FDH; A 16 FDL		11/11-	DG-608		4.4V				4
2.0 CDTi	99	A 20 FD		11/11-	DG-608		4.4V				4
CORSA I (B) (93-00)											
1.0 i 12V	40	X 10 XE		11/96-09/00	K20TXR	5063	1.0	K20TT	IK20TT	IK20TT	3
1.2 i	33	C 12 NZ; X 12 SZ	Ch: > 19334656, 19341717	03/93-09/00	W16EPR-U	3021	0.8	W16TT	IW16TT	IW16TT	4
1.2 i	33	C 12 NZ; X 12 SZ	Ch: 19K87118>	03/93-09/00	K20TXR	5063	1.0	K20TT	IK20TT	IK20TT	4
1.2 i 16V	48	X 12 XE		03/98-09/00	K20TXR	5063	1.0	K20TT	IK20TT	IK20TT	4
1.4 i	44	C 14 NZ; C14NZ;X14SZ		08/95-09/00	K20TXR	5063	1.0	K20TT	IK20TT	IK20TT	4
1.4 i	44	C 14 NZ; C14NZ		03/93-07/95	W16EPR-U	3021	0.8	W16TT	IW16TT	IW16TT	4
1.4 i 16V	66	X 14 XE		09/94-09/00	K20TXR	5063	1.0	K20TT	IK20TT	IK20TT	4
1.5 D	37	15 D		03/93-09/00	DG-300		11V				4
1.5 TD	49	15 DT (T4EC1); X 15 DT (T4EC1)		03/93-10/96	DG-300		11V				4
1.6 i 16V	78	C 16 XE; X 16 XE		09/94-09/00	K20TXR	5063	1.0	K20TT	IK20TT	IK20TT	4
1.7 D	44	17 D (4EE1); X 17 D (4EE1)		01/94-09/00	DG-300		11V				4
CORSA II (C) (00-06)											
1.0 12V	43	Z 10 XE		09/00-10/03	K20TXR	5063	1.0	K20TT	IK20TT	IK20TT	3

	KW				Standard			Twin Tip			QTY
VAUXHALL <i>continued</i>											
CORSA II (C) (00-06) <i>continued</i>											
1.0 12V	44	Z 10 XEP		11/03-10/06	KJ16CR-L11	3132	1.1	K16TT	IK16TT	IK16TT	3
1.2 16V	55	Z 12 XE		09/00-10/06	K20TXR	5063	1.0	K20TT	IK20TT	IK20TT	4
1.2 16V Dualfuel	55	Z 12 XE		08/01-10/06	K20TXR	5063	1.0	K20TT	IK20TT	IK20TT	4
1.2 Twinport	59	Z 12 XEP		07/04-10/06	KJ16CR-L11	3132	1.1	K16TT	IK16TT	IK16TT	4
1.3 CDTI 16V	52/55	Z 13 DT; Z 13 DTJ		04/04-09/06	DG-171		11V				4
1.4	66	Z 14 XEP		11/03-06/06	KJ16CR-L11	3132	1.1	K16TT	IK16TT	IK16TT	4
1.4 16V	66	Z 14 XE		09/00-10/06	K20TXR	5063	1.0	K20TT	IK20TT	IK20TT	4
1.4 Twinport	66	Z 14 XEP		06/03-10/06	KJ16CR-L11	3132	1.1	K16TT	IK16TT	IK16TT	4
1.7 CDTI 16V	74	Z 17 DTH		08/00-09/06	DG-302		11V				4
1.7 DI 16V	48	Y 17 DTL		08/00-09/06	DG-302		11V				4
1.7 DTI 16V	55	Y 17 DT		08/00-09/06	DG-302		11V				4
1.8 16V	92	Z 18 XE		08/00-09/06	K20TXR	5063	1.0	K20TT	IK20TT	IK20TT	4
CORSA III (D) (06-)											
1.0	44	A 10 XEP; Z 10 XEP		11/06-	KJ20CR-L11	3169	1.1	K20TT	IK20TT	IK20TT	3
1.0 i 12V	48	A10XEP		06/10-	KJ16CR-L11	3132	1.1	K16TT	IK16TT	IK16TT	3
1.2	59	Z 12 XEP		11/06-	KJ16CR-L11	3132	1.1	K16TT	IK16TT	IK16TT	4
1.2	51	A 12 XEL		01/10-	KJ20CR-L11	3169	1.1	K20TT	IK20TT	IK20TT	4
1.2 i 16V	63	A 12 XER		11/06-	KJ20CR-L11	3169	1.1	K20TT	IK20TT	IK20TT	4
1.2 LPG	59	Z 12 XEP		09/09-	KJ20CR-L11	3169	1.1	K20TT	IK20TT	IK20TT	4
1.2 LPG	61/63	A 12 XER		06/11-	VK20T	5501	0.8	-	IK20TT	IK20TT	4
1.3 CDTI	55/ 66/ 70	A 13 DTC; A 13 DTE; A 13 DTR; Z 13 DTE; Z 13 DTH; Z 13 DTJ		01/10-	DG-171		11V				4
1.4	66	Z 14 XEP		07/06-	KJ16CR-L11	3132	1.1	K16TT	IK16TT	IK16TT	4
1.4	64/74	A 14 XEL; A 14 XER		09/09-	KJ20CR-L11	3169	1.1	K20TT	IK20TT	IK20TT	4
1.4 LPG	66	Z 14 XEP		07/06-	KJ20CR-L11	3169	1.1	K20TT	IK20TT	IK20TT	4
1.4 LPG	64	A 14 XEL		09/09-	VK20T	5501	0.8	-	IK20TT	IK20TT	4
1.6 SRI	110	A16LEL		05/07-	IK20L	5358	1.1	-	IK20TT	IK20TT	4
1.6 VXR	141	A16LER		02/07-	IK20L	5358	1.1	-	IK20TT	IK20TT	4
1.7 CDTI	92/96	A 17 DTS; Z 17 DTR		11/06-	DG-302		11V				4
FRONTERA I (A) (91-98)											
2.0	85	C 20 NE; X 20 SE		04/95-08/98	K20TXR	5063	1.0	K20TT	IK20TT	IK20TT	4
2.0 i	85	C 20 NE; X 20 SE		03/92-10/98	K20TXR	5063	1.0	K20TT	IK20TT	IK20TT	4
2.2 i	100	X 22 XE		03/95-10/98	K20TXR	5063	1.0	K20TT	IK20TT	IK20TT	4
2.3 TD	74	23 DTR		09/91-06/98	DG-001		11V				4
2.4 i	92	C 24 NE		03/92-10/98	W20FPR-U	3070	0.7	WF20TT	-	-	4
2.5 TDS	85	25TDS (VM41B)		11/91-10/98	DG-109		11V				4
2.8 TD	83	28 TDI (4JB1T)		03/95-10/98	DG-108		11V				4
FRONTERA II (B) (98-04)											
2.2 DTI	85	X 22 DTH	Ch: >YV699999	10/98-09/04	DG-118		11V				4
2.2 DTI	85	Y 22 DTH	Ch: 1V500001>	10/98-09/04	DG-142		11V				4
2.2 i	100	X22SE		10/98-10/04	K16PR-U11	3130	1.1	K16TT	IK16TT	IK16TT	4
2.2 i	100	Y22SE		03/01-10/04	PK16PR-L11	3275	1.1	-	IK16TT	IK16TT	4
3.2 i	151	6VD1;Y32NE		10/98-10/04	PK16PR-L11	3275	1.1	-	IK16TT	IK16TT	6
INSIGNIA (08-)											
1.6	85	A16XER		07/08-	KJ16CR-L11	3132	1.1	K16TT	IK16TT	IK16TT	4
1.6 Turbo	132	A16LET		01/09-	IK20L	5358	1.1	-	IK20TT	IK20TT	4
1.8	103	A 18 XER		07/08-	KJ20CR-L11	3169	1.1	K20TT	IK20TT	IK20TT	4
2.0 CDTI	81/ 96/ 118	A 20 DTC; A 20 DTH; A 20 DTJ		07/08-	DG-608		4.4V				2
2.0 CDTI 4x4	118	A 20 DTH		07/08-	DG-608		4.4V				2
2.0 Turbo	162	A 20 NHT		07/08-	ITV20	5339	1.1	-	ITV20TT	ITV20TT	4
2.0 Turbo 4x4	162/ 184	A 20 NFT; A 20 NHT		07/08-	ITV20	5339	1.1	-	ITV20TT	ITV20TT	4
MERIVA I (A) (03-10)											
1.3 CDTI	51/55	Y 13 DT; Z 13 DT; Z 13 DTJ		01/03-06/10	DG-171		11V				4
1.4 16V Twinport	66	Z 14 XEP		01/03-10/09	KJ16CR-L11	3132	1.1	K16TT	IK16TT	IK16TT	4
1.6 i	64	Z 16 SE		01/03-06/10	K20TXR	5063	1.0	K20TT	IK20TT	IK20TT	4
1.6 i 16V	74	Z 16 XE		01/03-09/05	K20TXR	5063	1.0	K20TT	IK20TT	IK20TT	4
1.6 i 16V Twinport	77	Z 16 XEP		05/03-06/10	KJ16CR-L11	3132	1.1	K16TT	IK16TT	IK16TT	4
1.6 Turbo	132	Z 16 LET		05/06-06/10	PK20PR-L11	3142	1.1	-	IK20TT	IK20TT	4
1.7 CDTI 16V	74	Z 17 DTH		09/03-08/05	DG-302		11V				4
1.7 DTI 16V	55	Y 17 DT		06/03-06/10	DG-302		11V				4
1.8 i 16V	92	Z 18 XE		05/03-08/05	K20TXR	5063	1.0	K20TT	IK20TT	IK20TT	4









Spark & Glow Plugs







Application Tables

	KW					Standard			QTY
VAUXHALL <i>continued</i>									
MERIVA II (B) (10-)									
1.3 CDTI	55	A 13 DTC		06/10-	DG-621		4.4V		4
1.4	74	A 14 XER; B 14 XER		06/10-	KJ20CR-L11	3169	1.1	K20TT IK20TT IK20TT	4
1.7 CDTI	74/81	A 17 DT; A 17 DTC; A 17 DTI		06/10-	DG-302		11V		4
MIDI I (84-88)									
2.0 TD	50	4FC1		09/84-05/88	DG-145		11V		4
MIDI II (88-97)									
2.0	62	4ZC1		01/93-08/97	W20EPR-U	3047	0.8	W20TT IW20TT IW20TT	4
2.0 TD	51	4FC1T		06/88-07/90	DG-159		5V		4
2.2 D	45	4FD1		06/88-12/94	DG-159		5V		4
2.4 TD	56	4FG1T		09/94-08/97	DG-159		5V		4
MOKKA (12-)									
1.6	85	A16XER		06/12-	KJ16CR-L11	3132	1.1	K16TT IK16TT IK16TT	4
MONTEREY I (91-98)									
3.1 TD	84	4 JG2TC		09/91-07/98	DG-104		11V		4
3.2	130	6VDI		05/94-07/98	K20PR-U11	3121	1.1	K20TT IK20TT IK20TT	6
MONTEREY II (98-99)									
3.0 DTI	117	4 JX1		07/98-08/99	DG-186		11V		4
3.5 V6 24V	158	6 VE1		07/98-08/99	PK16PR-L11	3275	1.1	- IK16TT IK16TT	6
MOVANO I (A) (98-10)									
1.9 DTI	59/60	F9Q 770; F9Q 774		09/00-05/10	DG-005		11V		4
2.2 DTI	66	G9T 720; G9T 722; G9T 750		09/00-05/10	DG-126		11V		4
2.5 CDTI	74/88/107	G9U 632; G9U 650; G9U 754		08/06-05/10	DG-126		11V		4
2.5 D	59	S8U 770		10/98-09/00	DG-004		11.5V		4
2.5 DTI	84	G9U 720; G9U 724; G9U 750; G9U 754		10/01-05/10	DG-126		11V		4
NOVA (82-94)									
1.0	33	10 S		09/82-03/93	W20FPR-U	3070	0.7	WF20TT - -	4
1.2	38	12NV		01/90-03/93	W20EPR-U	3047	0.8	W20TT IW20TT IW20TT	4
1.2 i	33	12 NC; E 12 GV		01/85-10/89	W20EPR-U	3047	0.8	W20TT IW20TT IW20TT	4
1.2 i CAT	33	C 12 NZ		09/91-03/93	W20EPR-U	3047	0.8	W20TT IW20TT IW20TT	4
1.2 N	33/38	12 NV; E 12 GV		01/85-03/93	W20EPR-U	3047	0.8	W20TT IW20TT IW20TT	4
1.2 S	40/43	12 ST		05/83-02/90	W20EPR-U	3047	0.8	W20TT IW20TT IW20TT	4
1.3 S	51	13 SB		05/83-10/89	W20EPR-U	3047	0.8	W20TT IW20TT IW20TT	4
1.4	44	C 14 NZ		10/90-08/92	W20EPR-U	3047	0.8	W20TT IW20TT IW20TT	4
1.4 i	44	C 14 NZ		01/90-03/93	W20EPR-U	3047	0.8	W20TT IW20TT IW20TT	4
1.4 i S	60	C 14 SE		09/91-03/93	W20EPR-U	3047	0.8	W20TT IW20TT IW20TT	4
1.4 S	55	14 NV		01/90-03/93	W20EPR-U	3047	0.8	W20TT IW20TT IW20TT	4
1.5 D	37	15 D	Eng: >804794	09/87-10/94	DG-143		5V		4
1.5 D	37	15 D	Eng: 804795>	09/87-10/94	DG-124		11V		4
1.5 TD	49	15 DT (T4EC1)	Eng: >804794	01/90-03/93	DG-159		5V		4
1.5 TD	49	15 DT (T4EC1)	Eng: 804795>	01/90-03/93	DG-104		11V		4
1.6 GSI	74	E 16 SE		05/88-03/92	W20EPR-U	3047	0.8	W20TT IW20TT IW20TT	4
1.6 GSI CAT	74	C 16 SE		02/92-03/93	W20EPR-U	3047	0.8	W20TT IW20TT IW20TT	4
OMEGA (B) (94-03)									
2.0	85	20 SE; X 20 SE		03/94-09/99	K20TXR	5063	1.0	K20TT IK20TT IK20TT	4
2.0 16V	100	X 20 XEV		03/94-02/01	K20TXR	5063	1.0	K20TT IK20TT IK20TT	4
2.0 DTI 16V	74	X 20 DTH		01/98-09/00	DG-118		11V		4
2.2 16V	106	Y 22 XE; Z 22 XE		01/94-06/03	K20TXR	5063	1.0	K20TT IK20TT IK20TT	4
2.2 DTI 16V	88	Y 22 DTH		08/00-07/03	DG-142		11V		4
2.5 DTI 24V	110	Y 25 DT		09/01-07/03	DG-145		11V		6
2.5 TD	96	25 DT; X 25 DT		04/94-07/01	DG-001		11V		6
2.5 V6	125	X 25 XE		03/94-09/00	K20TNR	3304	1.0	K20TT IK20TT IK20TT	6
2.6 V6	132	Y 26 SE		08/00-07/03	K20TNR	3304	1.0	K20TT IK20TT IK20TT	6
3.0 V6	155	X 30 XE		04/94-07/00	K20TNR	3304	1.0	K20TT IK20TT IK20TT	6
3.2 V6	160	Y 32 SE		02/01-07/03	K20TNR	3304	1.0	K20TT IK20TT IK20TT	6
RASCAL (86-93)									
1.0	34	F10A		07/86-08/93	W16EPR-U	3021	0.8	W16TT IW16TT IW16TT	4
ROYALE (78-87)									
2.2 TD	63	23 TD		11/84-08/87	DG-001		11V		4
SENATOR II (B) (87-93)									
2.5 i	103	25 E		09/87-10/90	W20FPR-U	3070	0.7	WF20TT - -	6
2.6 i	110	C 26 NE		09/90-09/93	W20FPR-U	3070	0.7	WF20TT - -	6

Spark & Glow Plugs



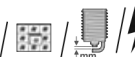



Application Tables

	KW								QTY		
VAUXHALL <i>continued</i>											
SENATOR II (B) (87-93) <i>continued</i>											
3.0	130	30 NE		01/88-09/90	W20FPR-U	3070	0.7	WF20TT	-	-	6
3.0 24V	150	C 30 SE		09/89-09/93	K20TXR	5063	1.0	K20TT	IK20TT	IK20TT	6
3.0 i CAT	130	C 30 NE		01/88-08/92	W20FPR-U	3070	0.7	WF20TT	-	-	6
SIGNUM (02-08)											
1.8	103	Z 18 XER		08/05-05/08	KJ16CR-L11	3132	1.1	K16TT	IK16TT	IK16TT	4
1.8	90	Z 18 XE	Ch: >31999999	06/03-07/05	K20TXR	5063	1.0	K20TT	IK20TT	IK20TT	4
1.8	90	Z 18 XE	Ch: 41000001>	06/03-07/05	KJ16CR-L11	3132	1.1	K16TT	IK16TT	IK16TT	4
1.9 CDTI	88	Z 19 DT	Ch: >71021891	04/04-03/08	DG-122		11V				4
1.9 CDTI	88	Z 19 DT	Ch: 71021892>	04/04-03/08	DG-196		11V				4
1.9 CDTI 16V	110	Z 19 DTH		04/04-03/08	DG-170		11V				4
2.0 DTI	74	Y 20 DTH		05/03-05/08	DG-142		11V				4
2.0 i Turbo	129	Z 20 NET		03/03-10/08	PK20PR-L11	3142	1.1	-	IK20TT	IK20TT	4
2.2 DTI	92	Y 22 DTR		05/03-05/08	DG-142		11V				4
2.2 i	114	Z22YH(P35A)		05/03-05/08	K20PBR	5060	0.85	K20TT	IK20TT	IK20TT	4
2.8 V6 Turbo	169/ 184	Z 28 NEL; Z 28 NET		07/05-08/08	IKH20	5344	1.1	-	IKH20TT	IKH20TT	6
3.0 CDTi	130	Y 30 DT		05/03-05/08	DG-312		11V				6
3.0 V6 CDTI	135	Z 30 DT		07/05-06/08	DG-312		11V				6
3.2 V6	155	Z32SE(211)		05/03-09/05	VK16	5603	1.1	-	IK16TT	IK16TT	6
SINTRA (96-99)											
2.2 DTI	85	X 22 DTH		07/97-04/99	DG-118		11V				4
2.2 i 16 V	104	X 22 XE		11/96-04/99	K20TXR	5063	1.0	K20TT	IK20TT	IK20TT	4
3.0 i 24V	148	X 30 XE		11/96-04/99	K20TXR	5063	1.0	K20TT	IK20TT	IK20TT	6
SPEEDSTER (VX220) (00-06)											
2.0 i Turbo	147	Z 20 LET		03/01-07/05	K20TXR	5063	1.0	K20TT	IK20TT	IK20TT	4
2.2 i	108	Z 22 SE		09/00-07/05	PT16VR13	5068	1.3	TV16TT	ITV16TT	ITV16TT	4
VXR20	162	Z 20 LET		03/01-09/06	K20TXR	5063	1.0	K20TT	IK20TT	IK20TT	4
TIGRA (94-00)											
1.4 16V	66	X 14 XE		07/94-12/00	K20TXR	5063	1.0	K20TT	IK20TT	IK20TT	4
1.6 16V	78	X 16 XE		07/94-12/00	K20TXR	5063	1.0	K20TT	IK20TT	IK20TT	4
TIGRA TwinTop (04-09)											
1.3 CDTI	51	Z 13 DT		06/04-08/09	DG-171		11V				4
1.4	66	Z 14 XEP		06/04-08/09	KJ16CR-L11	3132	1.1	K16TT	IK16TT	IK16TT	4
1.8	92	Z 18 XE		06/04-08/09	KJ16CR-L11	3132	1.1	K16TT	IK16TT	IK16TT	4
VECTRA I (B) (95-03)											
1.6 i	55	X 16 SZR		08/95-03/02	K20TXR	5063	1.0	K20TT	IK20TT	IK20TT	4
1.6 i 16V	74	X 16 XEL; Y 16 XE; Z 16 XE		08/95-03/02	K20TXR	5063	1.0	K20TT	IK20TT	IK20TT	4
1.7 TD	60	X 17 DT (TC4EE1)		10/95-11/96	DG-300		11V				4
1.8 i 16V	85/92	X 18 XE; X 18 XE1; Z 18 XE		10/95-07/03	K20TXR	5063	1.0	K20TT	IK20TT	IK20TT	4
2.0 DI 16V	60	X 20 DTL	Ch: > V1;V5;V7;VL;V P: VS	08/95-10/01	DG-133		11V				4
2.0 DI 16V	60	X 20 DTL	Ch: W1;W5;W7;XL; WP; WS>	08/95-10/01	DG-118		11V				4
2.0 DTi 16V	74	Y 20 DTH		08/95-10/01	DG-142		11V				4
2.0 DTi 16V	74	X 20 DTH	Ch: W1;W5;W7;XL; WP; WS>	08/95-10/01	DG-118		11V				4
2.0 i	82	20 NEJ		10/95-03/02	K20TXR	5063	1.0	K20TT	IK20TT	IK20TT	4
2.0 i 16V	100	X 20 XEV		10/95-01/01	K20TXR	5063	1.0	K20TT	IK20TT	IK20TT	4
2.2 DTI 16V	92	Y 22 DTR		08/95-10/01	DG-142		11V				4
2.2 i 16V	108	Z 22 SE; Z22SE		09/00-07/03	PT16VR13	5068	1.3	TV16TT	ITV16TT	ITV16TT	4
2.5 i GSi	143	X 25 XE		03/98-07/00	K20TXR	5063	1.0	K20TT	IK20TT	IK20TT	6
2.5 i V6	125	X 25 XE		09/95-08/00	K20TXR	5063	1.0	K20TT	IK20TT	IK20TT	6
2.6 i V6	125	Y 26 SE		09/00-07/03	K20TXR	5063	1.0	K20TT	IK20TT	IK20TT	6
VECTRA II (C) (00-08)											
1.6	77	Z 16 XEP	Ch: 41000001, 48000001>	01/06-07/08	KJ16CR-L11	3132	1.1	K16TT	IK16TT	IK16TT	4
1.6 16V	74	Z16XE		10/05-07/08	KJ16CR-L11	3132	1.1	K16TT	IK16TT	IK16TT	4
1.6 16V	74	Z16XEP	Ch: 41000001, 48000001>	06/04-09/05	KJ16CR-L11	3132	1.1	K16TT	IK16TT	IK16TT	4

	KW								QTY		
VAUXHALL <i>continued</i>											
VECTRA II (C) (00-08) <i>continued</i>											
1.8	81	Z18XEL(110)		04/02-09/05	VK16	5603	1.1	-	IK16TT	IK16TT	4
1.8	103	Z 18 XER	Ch: > 41000001, 48000001>	01/06-07/08	KJ16CR-L11	3132	1.1	K16TT	IK16TT	IK16TT	4
1.8 16V	90	Z18XE(122)		10/05-07/08	KJ16CR-L11	3132	1.1	K16TT	IK16TT	IK16TT	4
1.8 16V	90	Z18XE(125)		04/02-09/05	VK16	5603	1.1	-	IK16TT	IK16TT	4
1.8 16V	90	Z18XE-GPL	Flexible fuel	10/03-08/05	VK16	5603	1.1	-	IK16TT	IK16TT	4
1.8 16V Dualfuel	90	Z18XE-GPL	Flexible fuel	04/02-09/05	VK16	5603	1.1	-	IK16TT	IK16TT	4
1.9 CDTi	74/88	Z 19 DTL	Ch: > 71021891; 48999999	08/02-07/08	DG-122		11V				4
1.9 CDTi	74/88	Z 19 DTL	Ch: 71021892; 78>	08/02-07/08	DG-196		11V				4
1.9 CDTi 16V	110	Z 19 DTH		04/04-08/08	DG-170		11V				4
2.0 16V Turbo	129	Z 20 NET		01/00-10/08	PK20PR-L11	3142	1.1	-	IK20TT	IK20TT	4
2.0 DTi 16V	74	Y 20 DTH		04/02-10/08	DG-142		11V				4
2.2 16V	108	Z 22 SE		01/02-10/08	PT16VR13	5068	1.3	TV16TT	ITV16TT	ITV16TT	4
2.2 direct	114	Z22YH(P35A)		10/03-10/08	K20PBR	5060	0.85	K20TT	IK20TT	IK20TT	4
2.2 DTi 16V	92	Y 22 DTR		04/02-10/08	DG-142		11V				4
2.8 V6 Turbo	169/ 184/ 188	Z 28 NEL; Z 28 NET		08/05-07/08	IKH20	5344	1.1	-	IKH20TT	IKH20TT	6
3.0 CDTi	135	Z 30 DT		08/05-07/08	DG-312		11V				6
3.0 V6 CDTi	130	Y 30 DT		06/03-08/05	DG-312		11V				6
3.2 V6	155	Z32SE(210)		06/03-09/05	VK16	5603	1.1	-	IK16TT	IK16TT	6
VIVARO (A) (01-14)											
1.9 DI	59	F9Q 762		08/01-12/06	DG-005		11V				4
1.9 DTi	74	F9Q 760		08/01-12/06	DG-005		11V				4
2.0 16V	88	F4R.7.20		08/01-06/06	PK20PR-P8	3245	0.8	-	IK20TT	IK20TT	4
2.0 ECOTEC	86	F4R 820		08/06-07/14	PK20PR-P8	3245	0.8	-	IK20TT	IK20TT	4
2.5 CDTi	99/ 107	G9U 630; G9U 730		04/03-07/14	DG-126		11V				4
2.5 DTi	99	G9U 630; G9U 730		07/03-07/14	DG-126		11V				4
ZAFIRA I (A) (98-05)											
1.6 16V	74	X 16 XEL; Z 16 XE		04/99-08/05	K20TXR	5063	1.0	K20TT	IK20TT	IK20TT	4
1.6 CNG	71	Z16YNG	Flexible fuel	07/03-06/05	PK20PR-P8	3245	0.8	-	IK20TT	IK20TT	4
1.8 16V	85/92	X 18 XE1; Z 18 XE		05/99-08/05	K20TXR	5063	1.0	K20TT	IK20TT	IK20TT	4
1.8 Dualfuel	92	Z 18 XE		09/00-08/05	K20TXR	5063	1.0	K20TT	IK20TT	IK20TT	4
2.0	147	Z 20 LET		06/02-06/05	K20TXR	5063	1.0	K20TT	IK20TT	IK20TT	4
2.0 DI 16V	60	X 20 DTL		10/99-08/05	DG-118		11V				4
2.0 DTi 16V	74	Y 20 DTH	Ch: > 22;25;26;28;2B ; 2H;2G	04/99-08/05	DG-118		11V				4
2.0 DTi 16V	74	Y 20 DTH	Ch: 32;35;36;38;3B ; 3H;4G>	04/99-08/05	DG-142		11V				4
2.0 GSI Turbo	141	Z 20 LET		09/01-06/05	K20TXR	5063	1.0	K20TT	IK20TT	IK20TT	4
2.2 16V	108	Z 22 SE		11/98-08/04	PT16VR13	5068	1.3	TV16TT	ITV16TT	ITV16TT	4
2.2 D	92	Y 22 DTR		06/01-06/05	DG-142		11V				4
ZAFIRA II (B) (05-)											
1.6	77	Z16XEP		07/05-02/09	KJ16CR-L11	3132	1.1	K16TT	IK16TT	IK16TT	4
1.6	85	A 16 XER; Z 16 XER	Ch: > 92999999; 9G999999	12/07-	KJ16CR-L11	3132	1.1	K16TT	IK16TT	IK16TT	4
1.6	85	A 16 XER; Z 16 XER	Ch: A2000001; AG000001>	12/07-	KJ20CR-L11	3169	1.1	K20TT	IK20TT	IK20TT	4
1.7 CDTi	81/92	A 17 DTJ; A 17 DTR; Z 17 DTJ		01/08-	DG-302		11V				4
1.8	103	A 18 XER; Z 18 XER	Ch: > D2999999; AG999999	04/05-	KJ16CR-L11	3132	1.1	K16TT	IK16TT	IK16TT	4
1.8	103	A 18 XER; Z 18 XER	Ch: E2000001>	04/05-	KJ20CR-L11	3169	1.1	K20TT	IK20TT	IK20TT	4
1.9 CDTi	110	Z 19 DTH		07/05-	DG-170		11V				4
1.9 CDTi	74/88	Z 19 DTL	Ch: > 6299999999;6 G99 999	07/05-	DG-122		11V				4







Spark & Glow Plugs

Application Tables

	KW					Standard			Twin Tip				QTY	
VAUXHALL <i>continued</i>														
ZAFIRA II (B) (05-) <i>continued</i>														
1.9 CDTI	74/88	Z 19 DTL	Ch: 72000001:7G0 000 1>	07/05-	DG-196		11V							4
2.0	147	Z 20 LER		07/05-	KJ16CR-L11	3132	1.1	K16TT	IK16TT	IK16TT				4
2.0	176	Z 20 LEH		01/06-	PK20PR-P8	3245	0.8	-	IK20TT	IK20TT				4
2.2	110	Z22YH(150);Z22YH(P 35A)		07/05-	K20PBR	5060	0.85	K20TT	IK20TT	IK20TT				4
ZAFIRA III (C) (11-)														
1.8	85/88	A 18 XEL		10/11-	KJ16CR-L11	3132	1.1	K16TT	IK16TT	IK16TT				4
1.8	103	A 18 XER		10/11-	KJ20CR-L11	3169	1.1	K20TT	IK20TT	IK20TT				4
VOLVO														
66 (75-79)														
DL 1.1	33	B 11		08/75-11/79	W20FP-U	3068	0.7	WF20TT	-	-				4
GL 1.3	42	B 130		08/75-11/79	W20FP-U	3068	0.7	WF20TT	-	-				4
140 (66-75)														
1.8	55	B 18 A		08/66-07/68	W22FS-U	4025	0.7	-	-	-				4
1.8 S	55/74	B 18 A; B 18 B		08/66-07/68	W22FS-U	4025	0.7	-	-	-				4
2.0	60/ 70/ 91	B 20 A; B 20 D; B 20 E		08/68-04/75	W22FP-U	4021	0.7	-	-	-				4
2.0 S	60/ 70/ 73/ 74/ 85/ 91	B 20 A; B 20 B; B 20 D; B 20 E; B 20 F		08/68-07/74	W22FP-U	4021	0.7	-	-	-				4
164 (68-74)														
2.9	118	B 30 E		08/72-07/74	W20FPR-U	3070	0.7	WF20TT	-	-				6
2.9 E	96	B 30 A		08/68-07/73	W20FPR-U	3070	0.7	WF20TT	-	-				6
240 (74-93)														
2.0	76/ 86/ 89	B200E; B200K		08/84-07/92	W20EPR-U	3047	0.8	W20TT	IW20TT	IW20TT				4
2.0	66/71	B 19 A; B 19 K		08/76-08/83	W20EP-U	3043	0.8	W20TT	IW20TT	IW20TT				4
2.0	86/89	B200E		08/83-06/87	W22EPR-U	3088	0.8	W22TT	-	VW22				4
2.0	60	B 20 A		08/74-07/76	W22FP-U	4021	0.7	-	-	-				4
2.1	71/ 74/ 79	B 21 A		08/74-07/84	W20EP-U	3043	0.8	W20TT	IW20TT	IW20TT				4
2.1	90	B21E		08/74-02/79	W22EPR-U	3088	0.8	W22TT	-	VW22				4
2.1 Turbo	114	B21ET		08/80-07/85	W22EPR-U	3088	0.8	W22TT	-	VW22				4
2.3	81/ 83/ 85/ 98	B 230 A; B 230 K; B230E; B230F(113); B230F(116); B230K		08/84-12/89	W20EPR-U	3047	0.8	W20TT	IW20TT	IW20TT				4
2.3	82	B 23 A		08/80-07/84	W20EP-U	3043	0.8	W20TT	IW20TT	IW20TT				4
2.3	96/ 98/ 100/ 103	B23E(129); B23E(136); B230E		08/80-06/86	W22EPR-U	3088	0.8	W22TT	-	VW22				4
2.3 i CAT	85	B230F(116)		08/86-07/93	W20EPR-U	3047	0.8	W20TT	IW20TT	IW20TT				4
2.4 Diesel	58/60	D 24		08/78-08/93	DG-012		11V							6
260 (74-82)														
2.7	92/ 103	B27A; B27E;B27F; B27E		08/77-07/79	T20EPR-U	5032	0.8	T20TT	IT20TT	IT20TT				6
2.8	95/ 114	B28A;B28F; B28E;B28F; B28E		08/80-07/82	T20EPR-U	5032	0.8	T20TT	IT20TT	IT20TT				6
340-360 (75-91)														
1.4	51	B14.0		08/75-07/83	IWF20	5378	0.8	-	-	-				4
1.4	46/ 47/ 50/ 51/ 52/ 53	B14.1;B14.2;B14.3;B 14.4		01/83-12/86	W16EPR-U	3021	0.8	W16TT	IW16TT	IW16TT				4
1.6 Diesel	40	D 16		08/84-07/91	DG-006		11V							4
1.7	59	B172		08/85-07/91	W20EPR-U	3047	0.8	W20TT	IW20TT	IW20TT				4
2.0	65/ 66/ 68/ 70/ 75/ 77	B 19 A; B 200 K		08/80-07/87	W16EPR-U	3021	0.8	W16TT	IW16TT	IW16TT				4



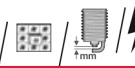



Spark & Glow Plugs







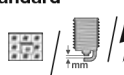

Application Tables

	KW								QTY		
VOLVO <i>continued</i>											
340-360 (75-91) <i>continued</i>											
2.0	80/ 81/ 82/ 83/ 85/ 87	B 19 E; B 200 E; B 200 EA; B 200 F		08/84-07/89	W20EPR-U	3047	0.8	W20TT	IW20TT	IW20TT	4
2.1	90	B 21 E		08/81-07/82	W20EPR-U	3047	0.8	W20TT	IW20TT	IW20TT	4
440 (88-96)											
1.6	61	B16F		10/91-12/96	J16CR-U	3256	0.8	W16TT	IW16TT	IW16TT	4
1.7	58/ 60/ 64/ 70/ 75/ 78	B 18 EP; B 18 F; B 18 FP; B 18 K; B 18 KD; B 18 KP		09/88-12/96	W20EPR-U	3047	0.8	W20TT	IW20TT	IW20TT	4
1.7 Turbo	88/90	B 18 FT		08/88-12/96	W22EPR-U	3088	0.8	W22TT	-	VW22	4
1.8	66	B 18 U		08/91-12/96	W20EPR-U	3047	0.8	W20TT	IW20TT	IW20TT	4
1.9 Turbo-Diesel	66	D 19 T		07/94-12/96	DG-012		11V				4
2.0	80/81	B20F		08/92-07/96	W22EPR-U	3088	0.8	W22TT	-	VW22	4
460 (88-96)											
1.6	61	B16F		07/92-07/96	J16CR-U	3256	0.8	W16TT	IW16TT	IW16TT	4
1.7	58/ 64/ 66/ 75/ 80	B 18 EP; B 18 KD; B 18 KP		08/89-07/92	W20EPR-U	3047	0.8	W20TT	IW20TT	IW20TT	4
1.7 Turbo	88/90	B 18 FT		08/89-07/96	W22EPR-U	3088	0.8	W22TT	-	VW22	4
1.8	66	B 18 U		08/91-07/96	W20EPR-U	3047	0.8	W20TT	IW20TT	IW20TT	4
1.9 Turbo-Diesel	66	D 19 T		07/94-07/96	DG-012		11V				4
2.0	80/81	B20F		08/92-07/96	W22EPR-U	3088	0.8	W22TT	-	VW22	4
480 (86-96)											
1.7	70/75	B18F; B18FP		08/87-07/96	J16CR-U	3256	0.8	W16TT	IW16TT	IW16TT	4
1.7	78	B18E		04/86-07/89	W22EPR-U	3088	0.8	W22TT	-	VW22	4
1.7	80	B18EP;B18FP	Check Hex size	08/86-07/88	J16CR-U	3256	0.8	W16TT	IW16TT	IW16TT	4
1.7	80	B18E;B18ED	Check Hex size	08/86-07/88	W22EPR-U	3088	0.8	W22TT	-	VW22	4
1.7 Turbo	88/90	B18FT;B18FTM		08/87-07/96	W22EPR-U	3088	0.8	W22TT	-	VW22	4
2.0	81	B20F		08/92-09/95	W22EPR-U	3088	0.8	W22TT	-	VW22	4
740 (83-92)											
2.0	76/ 82/ 89/ 118	B 200 ET; B 200 F; B 200 G; B 200 K		08/85-07/92	W20EPR-U	3047	0.8	W20TT	IW20TT	IW20TT	4
2.0	86/ 120	B 200 ET		01/85-08/88	W20EP-U	3043	0.8	W20TT	IW20TT	IW20TT	4
2.0 Turbo	114	B 200 FT		09/90-08/91	W20EPR-U	3047	0.8	W20TT	IW20TT	IW20TT	4
2.3	82/ 83/ 84/ 85/ 100/ 111/ 114/ 117	B 230 A; B 230 FB; B 230 K; B 234 F		08/87-07/92	W20EPR-U	3047	0.8	W20TT	IW20TT	IW20TT	4
2.3	82/ 86/ 96	B 230 A; B 230 E; B 230 K		08/84-07/88	W20EP-U	3043	0.8	W20TT	IW20TT	IW20TT	4
2.3 Turbo	115/ 121/ 125/ 140	B 230 FT; B 230 GT		08/86-07/90	W20EPR-U	3047	0.8	W20TT	IW20TT	IW20TT	4
2.3 Turbo	134	B 230 ET		08/85-12/88	W20EP-U	3043	0.8	W20TT	IW20TT	IW20TT	4
2.4 Diesel	60	D 24		08/84-07/92	DG-012		11V				6
2.4 TD Interc.	90	D 24 TIC		08/86-07/88	DG-012		11V				6
2.4 Turbo-Diesel	80	D 24 T		09/85-07/92	DG-012		11V				6
760 (81-92)											
2.3	121	B 230 FT		01/88-07/92	W20EPR-U	3047	0.8	W20TT	IW20TT	IW20TT	4
2.3 Turbo	115	B 230 FT		09/87-08/90	W20EPR-U	3047	0.8	W20TT	IW20TT	IW20TT	4
2.3 Turbo (704)	134	B 230 ET		08/84-10/88	W20EPR-U	3047	0.8	W20TT	IW20TT	IW20TT	4
2.4 D	60	D 24		01/82-07/92	DG-012		11V				6
2.4 TD Interc. (704)	85	D 24 TIC		08/87-07/92	DG-012		11V				6
2.4 TD Interc. (765)	85	D 24 TIC		08/87-07/92	DG-012		11V				6
2.4 Turbo Diesel (704)	80/82	D 24 T		08/82-07/92	DG-012		11V				6
2.8 (704)	105	B 280 F		05/86-08/91	T20EPR-U	5032	0.8	T20TT	IT20TT	IT20TT	6
2.8 (704, 764)	115	B 28 E		08/81-07/88	T20EPR-U	5032	0.8	T20TT	IT20TT	IT20TT	6
780 (86-90)											
2.9	108/ 115	B 280 E; B 280 F		08/86-07/90	T20EPR-U	5032	0.8	T20TT	IT20TT	IT20TT	6

Spark & Glow Plugs







Application Tables

	KW								QTY	
VOLVO continued										
850 (91-97)										
2.0	93/105	B5202FS; B5204FS		02/93-12/96	K20PBR-S10	5061 1.0	K20TT	IK20TT	IK20TT	5
2.0	93	B5202FS		08/94-12/96	K22PR-U	3165 0.8	-	-	VK22	5
2.0 Turbo	132/155	B 5204 T2; B5204FT; B5204T2		08/93-12/96	PK20PR-P8	3245 0.8	-	IK20TT	IK20TT	5
2.3 T5	166	B5234FT		02/93-12/96	PK20PR-P8	3245 0.8	-	IK20TT	IK20TT	5
2.3 T5-R	184	B5234T4		08/95-12/96	PK20PR-P8	3245 0.8	-	IK20TT	IK20TT	5
2.3 Turbo R	177	B5234T5		06/95-08/95	PK20PR-P8	3245 0.8	-	IK20TT	IK20TT	5
2.5	106/125	B5252FS; B5254FS		08/91-12/96	K20PBR-S10	5061 1.0	K20TT	IK20TT	IK20TT	5
2.5	103	B 5252		06/91-07/94	K20TXR	5063 1.0	K20TT	IK20TT	IK20TT	5
2.5	106/125	B5252FS; B5254FS		09/92-12/96	K22PR-U	3165 0.8	-	-	VK22	5
2.5 AWD	142	B5254T		04/96-12/96	PK20PR-P8	3245 0.8	-	IK20TT	IK20TT	5
2.5 TDI	103	D 5252 T		08/95-12/96	DG-005	11V				5
940 I (90-95)										
2.0	82	B 200 F		01/92-07/94	W20EPR-U	3047 0.8	W20TT	IW20TT	IW20TT	4
2.0 Turbo	114	B 200 FT		08/90-07/95	W20EPR-U	3047 0.8	W20TT	IW20TT	IW20TT	4
2.3	85/96/114/118	B 230 FB; B 230 FD; B 230 FT; B 234 F; B 234 G		08/90-12/94	W20EPR-U	3047 0.8	W20TT	IW20TT	IW20TT	4
2.3 Turbo	121/140	B 230 FT; B230FT; B230FT+(190); B234F		08/90-07/94	W20EPR-U	3047 0.8	W20TT	IW20TT	IW20TT	4
2.4 D	60	D 24		08/90-07/95	DG-012	11V				6
2.4 TD Intercooler	90	D 24 TIC		08/90-12/94	DG-012	11V				6
2.4 Turbo Diesel	80	D 24 T		08/90-12/94	DG-012	11V				6
940 II (94-98)										
2.0 Turbo	114	B 200 FT		04/96-10/98	W20EPR-U	3047 0.8	W20TT	IW20TT	IW20TT	4
2.3	85/96	B 230 FB; B 230 FD		08/94-10/98	W20EPR-U	3047 0.8	W20TT	IW20TT	IW20TT	4
2.3 ti	99	B 230 FK		01/95-10/98	W20EPR-U	3047 0.8	W20TT	IW20TT	IW20TT	4
2.3 Turbo	121/126	B 230 FT; B230GT(171)		08/94-12/98	W20EPR-U	3047 0.8	W20TT	IW20TT	IW20TT	4
2.4 TD Interc.	90	D 24 TIC		08/94-10/98	DG-012	11V				6
960 I (90-94)										
2.0	140	B 204 FT		08/90-09/93	W20EPR-U	3047 0.8	W20TT	IW20TT	IW20TT	4
2.3 Turbo	121	B 230 FT		09/90-08/93	W20EPR-U	3047 0.8	W20TT	IW20TT	IW20TT	4
2.4 TD Interc.	85	D 24 TIC		09/91-07/94	DG-012	11V				6
2.9	150	B 6304 S		08/90-07/94	K20TXR	5063 1.0	K20TT	IK20TT	IK20TT	6
2.9	150	B 6304 F		08/90-07/94	Q20PR-U	3007 0.8	Q20TT	IQ20TT	IQ20TT	6
960 II (94-96)										
2.5	125	B 6254 S		07/94-12/96	Q20PR-U	3007 0.8	Q20TT	IQ20TT	IQ20TT	6
2.9	150	B 6304 S		07/94-12/96	K20TXR	5063 1.0	K20TT	IK20TT	IK20TT	6
C30 (06-12)										
1.6	74	B 4164 S3		10/06-12/12	PT16VR13	5068 1.3	TV16TT	ITV16TT	ITV16TT	4
1.6 D	80	D 4164 T	Eng: >16125	10/06-12/12	DG-113	11V				4
1.6 D	80	D 4164 T	Eng: 16126>	10/06-12/12	DG-180	11V				4
1.6 D2	84	D 4162 T		10/10-12/12	DG-603	5V				4
1.8	92	B 4184 S11		10/06-12/12	ZT20EPR11	5087 1.1	T20TT	IT20TT	IT20TT	4
1.8 FlexFuel	92	B 4184 S8		01/07-12/12	ZT20EPR11	5087 1.1	T20TT	IT20TT	IT20TT	4
2.0	107	B 4204 S3		10/06-12/12	ZT20EPR11	5087 1.1	T20TT	IT20TT	IT20TT	4
2.0 D	100	D 4204 T		10/06-12/12	DG-181	11V				4
2.0 FlexFuel	107	B 4204 S4		01/10-12/12	ZT20EPR11	5087 1.1	T20TT	IT20TT	IT20TT	4
2.4 i	125	B 5244 S4		10/06-12/12	K20HR-U11	3381 1.1	KH20TT	IKH20TT	IKH20TT	5
D3	110	D 5204 T5		10/10-12/12	DG-610	4.4V				4
D4	130	D 5204 T		10/10-12/12	DG-610	4.4V				5
D5	120/132	D 5244 T13; D 5244 T8; D 5244 T9	Ch: >62745	10/06-12/12	DG-610	4.4V				5
T5	162/169	B 5254 T3; B 5254 T7		10/06-12/12	VKH22	5619 0.8	-	-	VKH22	5
C70 I (97-05)										
2.0	132	B5204T2		03/97-09/98	PK20PR-P8	3245 0.8	-	IK20TT	IK20TT	5
2.0 T	120/166	B5204T3; B5204T4-E2		03/98-09/02	PK20PR-P8	3245 0.8	-	IK20TT	IK20TT	5
2.3 T5	176/180	B5234T3-240; B5234T3-E2; B5234T		03/98-10/05	PK20PR-P8	3245 0.8	-	IK20TT	IK20TT	5
2.3 T-5	176	B5234T3-240; B5234T3-E2		03/97-09/02	PK20PR-P8	3245 0.8	-	IK20TT	IK20TT	5
2.4 T	147	B5244T-200; B5244T		07/02-10/05	PK20PR-P8	3245 0.8	-	IK20TT	IK20TT	5

	KW					Standard			Twin Tip			QTY
VOLVO <i>continued</i>												
C70 I (97-05) <i>continued</i>												
2.5	125	B5244S		06/98-03/00	K20PBR-S10	5061	1.0	K20TT	IK20TT	IK20TT		5
2.5	125	B5254S		05/99-02/01	PK20PR-P8	3245	0.8	-	IK20TT	IK20TT		5
2.5 T	142	B5244T;B5254T		03/97-09/02	PK20PR-P8	3245	0.8	-	IK20TT	IK20TT		5
C70 II (06-)												
2.0 D	100	D 4204 T		01/08-	DG-181		11V					4
2.4	103	B5244S5		03/06-04/10	K20HR-U11	3381	1.1	KH20TT	IKH20TT	IKH20TT		5
2.4 D	120	D 5244 T9	Ch: >49640	03/07-	DG-610		4.4V					5
2.4 i	125	B5244S4		03/06-04/10	K20HR-U11	3381	1.1	KH20TT	IKH20TT	IKH20TT		5
D5	132	D 5244 T8	Ch: >49640	03/06-	DG-610		4.4V					5
D5	132	D 5244 T8	Ch: >49641	03/06-04/10	DG-140		11V					5
T5	162/ 169	B 5254 T7; B5254T3		03/06-	VKH22	5619	0.8	-	-	VKH22		5
DUETT (61-67)												
1.8	50	B 18 A		08/61-07/67	W22FPR-U	4022	0.7	-	-	-		4
P 121 (59-71)												
1.6	44	B 16 A		05/59-09/66	W22FPR-U	4022	0.7	-	-	-		4
1.8	50/55	B 18 A		05/59-05/71	W22FPR-U	4022	0.7	-	-	-		4
2.0	60	B 20 A		11/68-05/71	W22FPR-U	4022	0.7	-	-	-		4
P 122 S Amazon (59-71)												
1.6	61	B 16		05/59-09/66	W22FPR-U	4022	0.7	-	-	-		4
1.8	59/ 63/ 66/ 76	B 18 D; B 18		05/59-05/71	W22FPR-U	4022	0.7	-	-	-		4
2.0	74	B 20 B		11/68-05/71	W22FPR-U	4022	0.7	-	-	-		4
P 544 (61-67)												
1.6	44/61	B 16 A; B 16 B		08/61-07/67	W22FPR-U	4022	0.7	-	-	-		4
1.8	50/59	B 18 A; B 18 D		08/61-07/67	W22FPR-U	4022	0.7	-	-	-		4
P 1800 (62-73)												
1.8	66/76			04/62-05/70	W22FPR-U	4022	0.7	-	-	-		4
1.8 S	71			04/62-05/70	W22FPR-U	4022	0.7	-	-	-		4
2.0 ES	91	B 20 E		04/72-11/73	W22FPR-U	4022	0.7	-	-	-		4
P 2200 (64-67)												
1.8	50/ 59/ 63			09/64-08/67	W22FPR-U	4022	0.7	-	-	-		4
S40 I (95-03)												
1.6	77/80	B 4164 S; B 4164 S2		09/95-12/03	K20PBR	5060	0.85	K20TT	IK20TT	IK20TT		4
1.8	85/90	B 4184 S; B 4184 S2; B 4184 S3; B 4184 S9		07/95-12/03	K20PBR	5060	0.85	K20TT	IK20TT	IK20TT		4
1.8 i	90/92	B 4184 SJ; B 4184 SM		03/98-12/03	VKB20	5625	1.1	-	-	VKB20		4
1.9 DI	70	D 4192 T2		03/99-07/00	DG-101		11V					4
1.9 DI	75/85	D 4192 T3; D 4192 T4		07/00-12/03	DG-122		11V					4
1.9 T4	147	B 4194 T; B 4194 T2		05/97-07/00	PK20PR-P8	3245	0.8	-	IK20TT	IK20TT		4
1.9 TD	66	D 4192 T		07/95-08/99	DG-012		11V					4
2.0	100/ 103	B 4204 S; B 4204 S2		07/95-12/03	K20PBR	5060	0.85	K20TT	IK20TT	IK20TT		4
2.0 T	118/ 120/ 121	B 4204 T; B 4204 T2; B 4204 T3		10/97-12/03	PK20PR-P8	3245	0.8	-	IK20TT	IK20TT		4
2.0 T4	147	B 4204 T5		07/00-12/03	PK20PR-P8	3245	0.8	-	IK20TT	IK20TT		4
S40 II (04-)												
1.6	74	B 4164 S3		01/05-	PT16VR13	5068	1.3	TV16TT	ITV16TT	ITV16TT		4
1.6 D	81	D 4164 T	Eng: >16125	01/05-	DG-113		11V					4
1.6 D	81	D 4164 T	Eng: 16126>	01/05-	DG-180		11V					4
1.6 D2	84	D 4162 T		10/10-	DG-603		5V					4
1.8	92	B 4184 S11		04/04-04/07	ZT20EPR11	5087	1.1	T20TT	IT20TT	IT20TT		4
1.8 FlexFuel	92	B4184S8(125)	Flexible fuel	01/06-10/09	VT20	5638	1.1	-	IT20TT	IT20TT		4
2.0	107	B 4204 S3		04/11-	VT20	5638	1.1	-	IT20TT	IT20TT		4
2.0	107	B 4204 S3		10/06-03/11	ZT20EPR11	5087	1.1	T20TT	IT20TT	IT20TT		4
2.0 D	100	D 4204 T		01/04-	DG-181		11V					4
2.4	103/ 125	B5244S4; B5244S5		01/04-04/10	K20HR-U11	3381	1.1	KH20TT	IKH20TT	IKH20TT		5
2.4 D5	132	D 5244 T8		03/06-04/10	DG-610		4.4V					5
T5	162/ 169	B 5254 T7; B5254T3		01/04-	VKH22	5619	0.8	-	-	VKH22		5



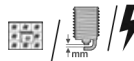



Spark & Glow Plugs

Application Tables

	KW								QTY	
VOLVO continued										
S40 II (04-) continued										
T5 AWD	162/169	B5254T3; B5254T7		04/04-04/10	VKH22	5619 0.8	-	-	VKH22	5
S60 I (00-10)										
2.0 T	132	B5204T5		07/00-03/09	PK20PR-P8	3245 0.8	-	-	IK20TT	5
2.4	103/125	B 5244 S2		11/00-04/10	K20PBR-S10	5061 1.0	K20TT	-	IK20TT	5
2.4 AWD	191	B 5244 T5		02/04-04/10	PK20PR-P8	3245 0.8	-	-	IK20TT	5
2.4 Bifuel (CNG)	103	B 5244 SG		06/02-04/10	PK20PR-P8	3245 0.8	-	-	IK20TT	5
2.4 Bifuel (LPG)	103	B 5244 SG2		06/02-04/10	K20PBR-S10	5061 1.0	K20TT	-	IK20TT	5
2.4 D	93/96/120	D5244T2(130); D5244T5(163); D5244T6(126)		12/01-03/09	DG-140		11V	-	-	5
2.4 D5	120/136	D5244T(163); D5244T-116(116); D5244T4(185)		07/01-03/09	DG-140		11V	-	-	5
2.4 T	147	B 5244 T3		11/00-04/10	PK20PR-P8	3245 0.8	-	-	IK20TT	5
2.4 T AWD	147	B 5244 T3		11/01-04/10	PK20PR-P8	3245 0.8	-	-	IK20TT	5
2.4 T5	191	B 5244 T5		04/04-04/10	PK20PR-P8	3245 0.8	-	-	IK20TT	5
2.5 T	154	B5254T2		02/04-03/09	PK20PR-P8	3245 0.8	-	-	IK20TT	5
2.5 T AWD	154	B5254T2		04/04-03/09	PK20PR-P8	3245 0.8	-	-	IK20TT	5
R 2,5 T AWD	221	B5254T4		03/03-04/07	VKH20Y	5639 0.8	-	-	VKH20Y	5
T5	184	B5234T3;B5234T7-E		11/00-12/04	PK20PR-P8	3245 0.8	-	-	IK20TT	5
S60 II (10-)										
2.0 T	149	B 4204 T6	40000km Lifetime	04/10-	ITV22	5340 0.8	-	-	-	4
D3	120	D 5204 T2		04/10-03/11	DG-610		4.4V	-	-	5
D4	120	D 5204 T3		05/12-	DG-610		4.4V	-	-	5
D5	151/158	D 5244 T10; D 5244 T11; D 5244 T15		04/10-	DG-610		4.4V	-	-	5
D5 AWD	151/158	D 5244 T10; D 5244 T15		04/10-	DG-610		4.4V	-	-	5
DRIVE / D2	84	D 4162 T		01/11-	DG-603		5V	-	-	4
T3	110	B 4164 T3	40000km Lifetime	04/10-	ITV20	5339 1.1	-	-	ITV20TT	4
T4	132	B 4164 T	40000km Lifetime	04/10-	ITV20	5339 1.1	-	-	ITV20TT	4
T4F	132	B 4164 T2	40000km Lifetime	04/11-	ITV20	5339 1.1	-	-	ITV20TT	4
T5	177	B 4204 T7	40000km Lifetime	04/10-	ITV22	5340 0.8	-	-	-	4
T6 AWD	224	B6304T4		04/10-	VFKH20	5655 1.1	-	-	IKH20TT	6
S70 (96-00)										
2.0	93	B5202FS		01/97-04/99	K20PBR-S10	5061 1.0	K20TT	-	IK20TT	5
2.0	120/132	B5204T2; B5204T4		01/97-11/00	PK20PR-P8	3245 0.8	-	-	IK20TT	5
2.0 Turbo	166	B5204T3		01/97-11/00	PK20PR-P8	3245 0.8	-	-	IK20TT	5
2.3 Turbo	184	B5234T3;B5234T4; B5234T7		01/97-11/00	PK20PR-P8	3245 0.8	-	-	IK20TT	5
2.4	103/125	B5244S2		05/99-11/00	K20PBR-S10	5061 1.0	K20TT	-	IK20TT	5
2.4 AWD	121	B5244S		10/98-05/99	K20PBR-S10	5061 1.0	K20TT	-	IK20TT	5
2.4 T5 AWD	142	B5244T		11/96-04/99	PK20PR-P8	3245 0.8	-	-	IK20TT	5
2.4 Turbo	142	B5244T;B5254T		01/97-11/00	PK20PR-P8	3245 0.8	-	-	IK20TT	5
2.5	106/121	B5252FS; B5254FS;B5254S		01/97-04/99	K20PBR-S10	5061 1.0	K20TT	-	IK20TT	5
2.5 Bifuel	103/106	B5244SG2; GB5252S;GB5252S2	Flexible fuel	10/98-11/00	K20PBR-S10	5061 1.0	K20TT	-	IK20TT	5
2.5 TDI	103	D 5252 T		01/97-11/00	DG-005		11V	-	-	5
S80 I (98-06)										
2.0	120	B5204T4		06/98-12/00	K20PBR-S10	5061 1.0	K20TT	-	IK20TT	5
2.0	120	B5204T4	OEM Optional	06/98-12/00	PK20PR-P8	3245 0.8	-	-	IK20TT	5
2.0 T	132/166	B5204T3; B5204T5		06/98-07/06	K20PBR-S10	5061 1.0	K20TT	-	IK20TT	5
2.0 T	132/166	B5204T3; B5204T5	OEM Optional	06/98-07/06	PK20PR-P8	3245 0.8	-	-	IK20TT	5
2.4	103/125	B5244S; B5244S2		01/99-07/06	K20PBR-S10	5061 1.0	K20TT	-	IK20TT	5
2.4	103/125	B5244S; B5244S2	OEM Optional	01/99-07/06	PK20PR-P8	3245 0.8	-	-	IK20TT	5
2.4 Bifuel (CNG)	103	B 5244 SG2		09/01-05/05	K20PBR-S10	5061 1.0	K20TT	-	IK20TT	5
2.4 Bifuel (CNG)	103	B 5244 SG2	OEM Optional	09/01-05/05	PK20PR-P8	3245 0.8	-	-	IK20TT	5
2.4 D	96	D5244T2(130)		10/01-02/06	DG-140		11V	-	-	5
2.4 D5	120	D5244T(163)		08/01-02/06	DG-140		11V	-	-	5
2.4 T	147	B5244T3		06/00-12/03	K20PBR-S10	5061 1.0	K20TT	-	IK20TT	5



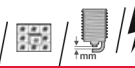



Spark & Glow Plugs





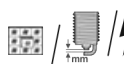

Application Tables







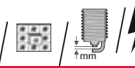

	KW								QTY		
VOLVO <i>continued</i>											
S80 I (98-06) <i>continued</i>											
2.4 T	147	B5244T3	OEM Optional	06/00-12/03	PK20PR-P8	3245	0.8	-	IK20TT	IK20TT	5
2.5 T	154	B5254T2		03/03-07/06	K20PBR-S10	5061	1.0	K20TT	IK20TT	IK20TT	5
2.5 T	154	B5254T2	OEM Optional	03/03-07/06	PK20PR-P8	3245	0.8	-	IK20TT	IK20TT	5
2.5 T AWD	154	B5254T2		07/03-07/06	K20PBR-S10	5061	1.0	K20TT	IK20TT	IK20TT	5
2.5 T AWD	154	B5254T2	OEM Optional	07/03-07/06	PK20PR-P8	3245	0.8	-	IK20TT	IK20TT	5
2.5 TDI	103	D 5252 T		01/99-07/06	DG-005		11V				5
2.8 T6	200	B6284T		05/98-12/99	K20PBR-S10	5061	1.0	K20TT	IK20TT	IK20TT	6
2.8 T6	200	B6284T	OEM Optional	05/98-12/99	PK20PR-P8	3245	0.8	-	IK20TT	IK20TT	6
2.9	147/150	B6294S; B6304S3		05/98-05/01	K20PBR-S10	5061	1.0	K20TT	IK20TT	IK20TT	6
2.9	150	B6304S3	OEM Optional	05/98-12/99	PK20PR-P8	3245	0.8	-	IK20TT	IK20TT	6
3.0	144	B6294S2		06/01-05/05	K20PBR-S10	5061	1.0	K20TT	IK20TT	IK20TT	6
3.0	144	B6294S2	OEM Optional	06/01-05/05	PK20PR-P8	3245	0.8	-	IK20TT	IK20TT	6
3.0 T6	200	B6294T		06/01-07/06	K20PBR-S10	5061	1.0	K20TT	IK20TT	IK20TT	6
3.0 T6	200	B6294T	OEM Optional	06/01-07/06	PK20PR-P8	3245	0.8	-	IK20TT	IK20TT	6
S80 II (06-)											
1.6 D DRiVe	80	D 4164 T	OE: 30711106	01/10-05/10	DG-113		11V				4
1.6 D DRiVe	80	D 4164 T	OE: 31216248	01/10-05/10	DG-180		11V				4
1.6 DRiVe	84	D 4162 T		06/11-	DG-603		5V				4
2.0	107	B 4204 S3		01/08-	ZT20EPR11	5087	1.1	T20TT	IT20TT	IT20TT	4
2.0 FlexFuel	107	B 4204 S4		01/08-	ZT20EPR11	5087	1.1	T20TT	IT20TT	IT20TT	4
2.0 T	149	B4204T6(203)		01/10-09/10	VKH22	5619	0.8	-	-	VKH22	4
2.0 TDi	100	D 4204 T		02/08-05/10	DG-181		11V				4
2.4 D	120	D 5244 T; D 5244 T5		03/06-04/11	DG-140		11V				5
2.4 D	129	D 5244 T14	OE: 8653880	01/10-04/10	DG-610		4.4V				5
2.5 T	147/170	B5254T10(231); B5254T6(200)		03/06-05/10	VKH22	5619	0.8	-	-	VKH22	5
2.5 T FlexFuel	170	B 5254 T11		01/10-	VKH20Y	5639	0.8	-	-	VKH20Y	5
2.5 T FlexFuel	147	B5254T8	Flexible fuel	05/08-04/09	VKH22	5619	0.8	-	-	VKH22	5
3.2	175	B6324S(238)	Ch: >134000	01/08-	IKH22	5345	0.8	-	-	VKH22	6
3.2	175	B6324S(238)	Ch: 134001>	03/06-01/07	IKH22	5345	0.8	-	-	VKH22	6
3.2 AWD	175	B6324S(238)	Ch: >134000	01/07-	IKH22	5345	0.8	-	-	VKH22	6
3.2 AWD	175	B6324S(238)	Ch: 134001>	01/07-01/07	IKH22	5345	0.8	-	-	VKH22	6
4.4 V8 AWD	232	B8444S(315)		03/06-09/10	SK20PR-A11	3418	1.1	-	IK20TT	IK20TT	8
D3	100	D 5204 T7		05/12-	DG-610		4.4V				4
D3 / D4	120	D 5204 T2; D 5204 T3		01/10-	DG-610		4.4V				5
D5	136/151	D 5244 T10; D 5244 T4		03/06-04/11	DG-140		11V				5
D5	158	D 5244 T11; D 5244 T15	OE: 8653880	06/11-	DG-610		4.4V				5
D5 AWD	136/151	D 5244 T10; D 5244 T4		01/07-	DG-140		11V				5
D5 AWD	158	D 5244 T15	OE: 8653880	06/11-	DG-610		4.4V				5
T4	132	B 4164 T	40000km Lifetime	10/10-	ITV20	5339	1.1	-	ITV20TT	ITV20TT	4
T4F	132	B 4164 T2	40000km Lifetime	05/11-	ITV20	5339	1.1	-	ITV20TT	ITV20TT	4
T5	177	B4204T7		10/10-	ITV20	5339	1.1	-	ITV20TT	ITV20TT	4
T6 AWD	210/224	B6304T2(285); B6304T4	Ch: >134000	01/07-	VKH22	5619	0.8	-	-	VKH22	6
T6 AWD	210/224	B6304T2(285); B6304T4	Ch: 134001>	01/07-	VFKH20	5655	1.1	-	IKH20TT	IKH20TT	6
S90 (96-98)											
2.9	132/150	B6304S1; B6304S2; B6304S2		01/97-05/98	K20PR-U	3145	0.8	K20TT	IK20TT	IK20TT	6
V40 (95-04)											
1.6	77/80	B 4164 S; B 4164 S2		12/95-06/04	K20PBR	5060	0.85	K20TT	IK20TT	IK20TT	4
1.8	85/90	B 4184 S; B 4184 S2; B 4184 S3; B 4184 S9		07/95-06/04	K20PBR	5060	0.85	K20TT	IK20TT	IK20TT	4
1.8 i	90/92	B 4184 SJ; B 4184 SM		03/98-06/04	VKB20	5625	1.1	-	-	VKB20	4
1.9 DI	70	D 4192 T2		03/99-07/00	DG-101		11V				4
1.9 DI	75/85	D 4192 T3; D 4192 T4		07/00-06/04	DG-122		11V				4
1.9 T4	147	B 4194 T		05/97-07/00	PK20PR-P8	3245	0.8	-	IK20TT	IK20TT	4
1.9 TD	66	D 4192 T		07/95-08/99	DG-012		11V				4











Spark & Glow Plugs









Application Tables

	KW								QTY		
VOLVO <i>continued</i>											
V40 (95-04) <i>continued</i>											
2.0	100/103	B 4204 S; B 4204 S2		07/95-06/04	K20PBR	5060	0.85	K20TT	IK20TT	IK20TT	4
2.0 T	118/120/121	B 4204 T; B 4204 T2; B 4204 T3		10/97-06/04	PK20PR-P8	3245	0.8	-	IK20TT	IK20TT	4
2.0 T4	147	B 4204 T5		07/00-06/04	PK20PR-P8	3245	0.8	-	IK20TT	IK20TT	4
V40 (12-)											
D2	84	D 4162 T		03/12-	DG-603		5V				4
T3 GTDi	110	B 4164 T3	40000km Lifetime	03/12-	ITV20	5339	1.1	-	ITV20TT	ITV20TT	4
T4 GTDi	132	B 4164 T	40000km Lifetime	03/12-	ITV20	5339	1.1	-	ITV20TT	ITV20TT	4
V50 (04-)											
1.6	74	B 4164 S3		01/05-	PT16VR13	5068	1.3	TV16TT	ITV16TT	ITV16TT	4
1.6 D	81	D 4164 T	Eng: >16125	01/05-	DG-113		11V				4
1.6 D	81	D 4164 T	Eng: 16126>	01/05-	DG-180		11V				4
1.6 D2	84	D 4162 T		01/10-	DG-180		11V				4
1.8	92	B 4184 S11		04/04-	ZT20EPR11	5087	1.1	T20TT	IT20TT	IT20TT	4
1.8 FlexFuel	92	B4184S8(125)	Flexible fuel	05/06-10/09	VT20	5638	1.1	-	IT20TT	IT20TT	4
2.0	107	B4204S3		10/06-	IKH22	5345	0.8	-	-	VKH22	4
2.0 D	100	D 4204 T		04/04-	DG-181		11V				4
2.0 FlexFuel	107	B4204S4	Flexible fuel	01/10-	VKH22	5619	0.8	-	-	VKH22	4
2.4	103/125	B5244S4; B5244S5		04/04-04/10	K20HR-U11	3381	1.1	KH20TT	IKH20TT	IKH20TT	5
2.4 D5	132	D 5244 T8	OE: 8631607	03/06-03/07	DG-140		11V				5
2.4 D5	132	D 5244 T8	OE: 8653880	03/06-03/07	DG-610		4.4V				5
2.4 Tdi	120	D 5244 T9	OE: 8631607	05/07-04/10	DG-140		11V				5
2.4 Tdi	120	D 5244 T9	OE: 8653880	05/07-04/10	DG-610		4.4V				5
T5	162/169	B5254T3; B5254T7		04/04-04/10	VKH22	5619	0.8	-	-	VKH22	5
T5 AWD	162/169	B 5254 T7; B5254T3		04/04-	VKH22	5619	0.8	-	-	VKH22	5
V60 (10-)											
1.6 DRiVe	84	D 4162 T		06/11-	DG-603		5V				4
2.0 T	149	B 4204 T6	40000km Lifetime	09/10-	ITV22	5340	0.8	-	-	-	4
2.4 D5	158	D 5244 T11; D 5244 T15		06/11-	DG-610		4.4V				5
2.4 D5 AWD	158	D 5244 T15		06/11-	DG-610		4.4V				5
D3 / D4	120	D 5204 T2; D 5204 T3		09/10-	DG-610		4.4V				5
D5	151	D 5244 T10		09/10-04/11	DG-610		4.4V				5
D5 AWD	151	D 5244 T10		09/10-04/11	DG-610		4.4V				5
T3	110	B 4164 T3	40000km Lifetime	09/10-	ITV20	5339	1.1	-	ITV20TT	ITV20TT	4
T4	132	B 4164 T	40000km Lifetime	09/10-	ITV20	5339	1.1	-	ITV20TT	ITV20TT	4
T4F	132	B 4164 T2	40000km Lifetime	04/11-	ITV20	5339	1.1	-	ITV20TT	ITV20TT	4
T5	177	B 4204 T7	40000km Lifetime	09/10-	ITV22	5340	0.8	-	-	-	4
T6 AWD	224	B6304T4		09/10-	VFKH20	5655	1.1	-	IKH20TT	IKH20TT	6
V70 I (96-00)											
2.0	93	B 5202 S		01/97-03/00	K20TXR	5063	1.0	K20TT	IK20TT	IK20TT	5
2.0	120/132	B 5204 T2; B 5204 T4		01/97-03/00	PK20PR-P8	3245	0.8	-	IK20TT	IK20TT	5
2.0 Turbo	166	B 5204 T3		01/97-03/00	PK20PR-P8	3245	0.8	-	IK20TT	IK20TT	5
2.0 Turbo AWD	166	B 5204 T3		01/97-03/00	PK20PR-P8	3245	0.8	-	IK20TT	IK20TT	5
2.3 AWD	177	B 5234 T3		04/97-09/98	PK20PR-P8	3245	0.8	-	IK20TT	IK20TT	5
2.3 T AWD	184	B 5234 FT+		04/97-03/00	PK20PR-P8	3245	0.8	-	IK20TT	IK20TT	5
2.3 T-5	176	B 5234 T3		01/97-03/00	PK20PR-P8	3245	0.8	-	IK20TT	IK20TT	5
2.3 T-5 AWD	176	B 5234 T3		01/97-03/00	PK20PR-P8	3245	0.8	-	IK20TT	IK20TT	5
2.3 Turbo	184	B 5234 FT+		01/97-03/00	PK20PR-P8	3245	0.8	-	IK20TT	IK20TT	5
2.4	103/125	B 5244 S2; B 5254 S		01/97-05/00	K20TXR	5063	1.0	K20TT	IK20TT	IK20TT	5
2.4 Bifuel	103	B5244SG2	Flexible fuel	08/99-03/00	K20PBR-S10	5061	1.0	K20TT	IK20TT	IK20TT	5
2.4 Turbo	142	B5244T;B5254T		01/97-03/00	PK20PR-P8	3245	0.8	-	IK20TT	IK20TT	5
2.5	106/121	B 5252 S; B 5254 S		01/97-03/00	K20TXR	5063	1.0	K20TT	IK20TT	IK20TT	5
2.5 AWD	195	B5244T2		03/99-03/00	PK20PR-P8	3245	0.8	-	IK20TT	IK20TT	5
2.5 Bifuel	106	GB5252S	Flexible fuel	10/98-08/99	K20PBR-S10	5061	1.0	K20TT	IK20TT	IK20TT	5
2.5 TDI	103	D 5252 T		01/97-05/00	DG-005		11V				5

	KW								QTY		
VOLVO <i>continued</i>											
V70 I (96-00) <i>continued</i>											
2.5 Turbo AWD	142	B 5254 T		01/97-05/00	IK22	5310	0.8	-	-	VK22	5
V70 II (00-07)											
2.0 T	132	B5204T5		08/04-08/07	VKH22	5619	0.8	-	-	VKH22	5
2.0 T	132	B5204T5	Ch: >349000	07/01-07/04	PK20PR-P8	3245	0.8	-	IK20TT	IK20TT	5
2.3 T5	184	B 5234 T3		03/00-08/04	PK20PR-P8	3245	0.8	-	IK20TT	IK20TT	5
2.4	103	B 5244 S2		03/00-08/07	K20PR-U	3145	0.8	K20TT	IK20TT	IK20TT	5
2.4	125	B 5244 S		03/00-08/07	K20TXR	5063	1.0	K20TT	IK20TT	IK20TT	5
2.4 Bifuel (CNG)	103	B5244SG;B5244SG2	Flexible fuel	09/01-08/07	VK20T	5501	0.8	-	IK20TT	IK20TT	5
2.4 D	93/96	D 5244 T7; D5244T2(130)		12/01-04/07	DG-140		11V				5
2.4 D5	120/ 136	D 5244 T; D 5244 T3; D 5244 T5; D5244T4(185)		08/01-08/07	DG-140		11V				5
2.4 D5 AWD	120/ 136	D5244T(163); D5244T4(185)		03/03-08/07	DG-140		11V				5
2.4 T	147	B 5244 T3		03/00-08/03	PK20PR-P8	3245	0.8	-	IK20TT	IK20TT	5
2.4 T AWD	147	B 5244 T3		09/01-08/02	PK20PR-P8	3245	0.8	-	IK20TT	IK20TT	5
2.4 T5	191	B 5244 T5		04/04-08/07	PK20PR-P8	3245	0.8	-	IK20TT	IK20TT	5
2.5 T	154	B 5254 T2		04/04-08/07	PK20PR-P8	3245	0.8	-	IK20TT	IK20TT	5
2.5 T	154	B5254T2		04/04-08/07	VKH22	5619	0.8	-	-	VKH22	5
2.5 T AWD	154	B 5254 T2		09/02-08/07	PK20PR-P8	3245	0.8	-	IK20TT	IK20TT	5
2.5 TDI	103	D 5252 T		03/00-08/07	DG-005		11V				5
R 2,5 T AWD	221	B5254T4		03/03-08/07	VKH20Y	5639	0.8	-	-	VKH20Y	5
V70 III (07-)											
1.6 D	80	D 4164 T	OE: 30711106	01/10-07/11	DG-113		11V				4
1.6 D	80	D 4164 T	OE: 31216248	01/10-07/11	DG-180		11V				4
1.6 DRIVE / D2	84	D 4162 T		06/11-	DG-180		11V				4
1.6 T4F	132	B 4164 T2	40000km Lifetime	01/11-	ITV20	5339	1.1	-	ITV20TT	ITV20TT	4
2.0	107	B 4204 S3		10/07-05/10	ZT20EPR11	5087	1.1	T20TT	IT20TT	IT20TT	4
2.0 D	100	D 4204 T		10/07-05/10	DG-181		11V				4
2.0 FlexiFuel	107	B 4204 S4		01/08-	ZT20EPR11	5087	1.1	T20TT	IT20TT	IT20TT	4
2.0 T	149	B4204T6(203)		01/10-09/10	VKH22	5619	0.8	-	-	VKH22	4
2.4 D	120/ 129	D 5244 T14; D 5244 T5		08/07-09/10	DG-610		4.4V				5
2.5 T	147	B 5254 T6		08/07-	VKH20	5618	1.1	-	IKH20TT	IKH20TT	5
2.5 T	170	B 5254 T10		01/10-	VKH22	5619	0.8	-	-	VKH22	5
2.5 T FlexiFuel	147	B 5254 T8		05/08-	VKH20Y	5639	0.8	-	-	VKH20Y	5
2.5 T FlexiFuel	170	B 5254 T11		10/09-	VKH22	5619	0.8	-	-	VKH22	5
3.2	175	B6324S(238)		08/07-05/10	IKH22	5345	0.8	-	-	VKH22	6
3.2	175	B6324S5	Ch: >167000	05/10-	VKH22	5619	0.8	-	-	VKH22	6
3.2	175	B6324S5	Ch: 167001>	08/07-	VFKH20	5655	1.1	-	IKH20TT	IKH20TT	6
3.2 AWD	175	B6324S(238)		08/07-05/10	IKH22	5345	0.8	-	-	VKH22	6
3.2 AWD	175	B6324S5	Ch: >167000	05/10-	VKH22	5619	0.8	-	-	VKH22	6
3.2 AWD	175	B6324S5	Ch: 167001>	08/07-	VFKH20	5655	1.1	-	IKH20TT	IKH20TT	6
D3 / D4	120	D 5204 T2; D 5204 T3		03/10-	DG-610		4.4V				5
D5	136/ 158	D 5244 T11; D 5244 T15; D 5244 T4		08/07-	DG-610		4.4V				5
D5 AWD	136/ 158	D 5244 T15; D 5244 T4		10/07-	DG-610		4.4V				5
T4	132	B 4164 T	40000km Lifetime	10/10-	ITV20	5339	1.1	-	ITV20TT	ITV20TT	4
T5	177	B4204T7		01/10-	ITV20	5339	1.1	-	ITV20TT	ITV20TT	4
T6 AWD	224	B 6304 T4	Ch: >167000	04/11-	VKH22	5619	0.8	-	-	VKH22	6
T6 AWD	210	B 6304 T2	Ch: >94000	08/07-	VKH22	5619	0.8	-	-	VKH22	6
T6 AWD	224	B 6304 T4	Ch: 167001>	04/11-	VFKH20	5655	1.1	-	IKH20TT	IKH20TT	6
T6 AWD	210	B 6304 T2	Ch: 94001>	08/07-	VFKH20	5655	1.1	-	IKH20TT	IKH20TT	6
V90 (96-98)											
2.5	125/ 132	B 6244 FS; B 6254 FS		11/96-10/98	K20PBR-S10	5061	1.0	K20TT	IK20TT	IK20TT	6
2.9	132/ 150	B6304S1;B6304S2; B6304S2		01/97-12/98	K20PR-U	3145	0.8	K20TT	IK20TT	IK20TT	6







	KW										QTY
VOLVO continued											
XC60 (08-)											
2.0 T	149	B4204T6		03/10-03/11	ITV20	5339	1.1	-	ITV20TT	ITV20TT	4
2.4 D / D3 / D4 AWD	120	D 5244 T5		05/08-05/09	DG-610		4.4V				5
3.2 AWD	179	B6324S5	Eng: >134999	03/10-	IKH22	5345	0.8	-	-	VKH22	6
3.2 AWD	179	B6324S5	Eng: 135000>	03/10-	VFKH20	5655	1.1	-	IKH20TT	IKH20TT	6
3.2 AWD	175	B6324S(238)	Ch: >134999	07/09-	IKH22	5345	0.8	-	-	VKH22	6
3.2 AWD	175	B6324S(238)	Ch: 135000>	07/09-03/10	VFKH20	5655	1.1	-	IKH20TT	IKH20TT	6
D5 AWD	136	D 5244 T4		05/08-04/09	DG-610		4.4V				5
T5	177	B4204T7		09/10-	ITV20	5339	1.1	-	ITV20TT	ITV20TT	4
T6 AWD	210	B6304T2(285)	Ch: >134999	05/08-	IKH22	5345	0.8	-	-	VKH22	6
T6 AWD	224	B6304T4	Ch: >134999	03/10-	VKH22	5619	0.8	-	-	VKH22	6
T6 AWD	210/ 224	B6304T2(285); B6304T4	Ch: 135000>	05/08-	VFKH20	5655	1.1	-	IKH20TT	IKH20TT	6
XC70 I Cross Country (97-07)											
2.4 D5 AWD	136	D5244T4(185)		12/05-03/07	DG-140		11V				5
2.4 D5 XC AWD	120	D5244T(163)		09/02-08/05	DG-140		11V				5
2.4 T XC AWD	142/ 147	B 5244 T3; B 5254 T		11/97-09/02	PK20PR-P8	3245	0.8	-	IK20TT	IK20TT	5
2.5 T XC AWD	154	B5254T2		09/02-08/07	PK20PR-P8	3245	0.8	-	IK20TT	IK20TT	5
XC70 II (07-)											
2.4 D	129	D 5244 T14		01/10-	DG-610		4.4V				5
2.4 D / D4 AWD	120	D 5244 T16; D 5244 T5		08/07-	DG-610		4.4V				5
3.2 AWD	175	B6324S	Ch: >94000	08/07-	VKH22	5619	0.8	-	-	VKH22	6
3.2 AWD	175	B6324S	Ch: 94001>	08/07-	VFKH20	5655	1.1	-	IKH20TT	IKH20TT	6
D3	120	D 5204 T2; D 5204 T3		08/11-	DG-610		4.4V				5
D5 AWD	136/ 151/ 158	D 5244 T10; D 5244 T11; D 5244 T15; D 5244 T4		08/07-	DG-610		4.4V				5
T6 AWD	210/ 224	B 6304 T2; B 6304 T4	Ch: >94000	01/08-	VKH22	5619	0.8	-	-	VKH22	6
T6 AWD	210/ 224	B 6304 T2; B 6304 T4	Ch: 94001>	01/08-	VFKH20	5655	1.1	-	IKH20TT	IKH20TT	6
XC90 I (02-)											
2.5 T	154	B5254T2		10/02-09/07	PK20PR-P8	3245	0.8	-	IK20TT	IK20TT	5
3.2 AWD	175/ 179	B6324S(238) E4; B6324S5	Ch: >568000	05/06-	IKH22	5345	0.8	-	-	VKH22	6
3.2 AWD	175/ 179	B6324S(238) E4; B6324S5	Ch: 568001>	05/06-	VFKH20	5655	1.1	-	IKH20TT	IKH20TT	6
D3 / D5	120	D 5244 T5		04/09-	DG-610		4.4V				5
D5	120/ 136	D 5244 T; D 5244 T4; D 5244 T5		10/02-09/07	DG-140		11V				5
D5	136/ 147	D 5244 T18; D 5244 T4		10/07-	DG-610		4.4V				5
T6	200	B6294T		10/02-09/07	PK20PR-P8	3245	0.8	-	IK20TT	IK20TT	6
V8	232	B8444S(315)		01/05-09/10	SK20PR-A11	3418	1.1	-	IK20TT	IK20TT	8
VW											
181 (69-79)											
1.5	32	H		09/69-07/70	W16FSR	3033	0.7	-	-	-	4
1.6	32/35	AG; AL; AM		08/70-02/79	W16FSR	3033	0.7	-	-	-	4
1500, 1600 (61-73)											
1.5	33	K		04/61-07/73	W16FSR	3033	0.7	-	-	-	4
1.5 L	33	K		07/68-07/73	W16FSR	3033	0.7	-	-	-	4
1.5 S	40			08/63-07/65	W20FSR-U	6053	0.7	WF20TT	-	-	4
1.6	40	T; U		08/65-07/73	W20FSR-U	6053	0.7	WF20TT	-	-	4
1.6 L	37	P		07/64-07/73	W16FSR	3033	0.7	-	-	-	4
1.6 L	40	T; U		08/65-07/73	W20FSR-U	6053	0.7	WF20TT	-	-	4
1.6 TL	40	T; U		08/65-07/73	W20FSR-U	6053	0.7	WF20TT	-	-	4
AMAROK (10-)											
2.0 BiTDI	120/ 132	CDCA; CNEA		09/10-	DG-193		4.4V				4
2.0 BiTDI 4motion	120/ 132	CDCA; CNEA; CSHA		09/10-	DG-193		4.4V				4
2.0 TDI	90	CDBA; CNFA		09/10-	DG-193		4.4V				4
2.0 TDI 4motion	90	CDBA; CNFA		09/10-	DG-193		4.4V				4
2.0 TSI	118	CFPA		12/10-	PK22PR8	3273	0.8	-	-	VK22	4





	KW										QTY
VW continued											
BEETLE (5C) (11-)											
1.4 TSI	118	CAVD; CNWA; CTHD; CTKA		04/11-	PKJ20CR8	3173	0.8	-	-	VK20G	4
1.6 TDI	77	CAYC		10/11-	DG-193		4.4V				4
2.0 TDI	103	CFFB		04/11-	DG-193		4.4V				4
2.0 TSI	147/155	CBFA; CCTA; CCZA; CPLA; CPPA		04/11-	PK22PR8	3273	0.8	-	-	VK22	4
BORA (1J) (98-05)											
1.4 16V	55	AHW; AKQ		03/00-05/05	K20PBR-S10	5061	1.0	K20TT	IK20TT	IK20TT	4
1.6	74/75	AEH; AKL; BFQ		05/99-05/05	K20PBR-S10	5061	1.0	K20TT	IK20TT	IK20TT	4
1.6 16V	77	AUS		02/00-05/05	K20PBR-S10	5061	1.0	K20TT	IK20TT	IK20TT	4
1.6 16V	77	AZD; BCB		02/00-05/05	PKJ16CR-L11	3246	1.1	-	IK16TT	IK16TT	4
1.6 FSI	81	BAD		01/02-05/05	K20PBR-S10	5061	1.0	K20TT	IK20TT	IK20TT	4
1.8	92	AGN; BAF		10/98-05/05	K20PBR-S10	5061	1.0	K20TT	IK20TT	IK20TT	4
1.8 4motion	92	AGN		02/99-05/05	K20PBR-S10	5061	1.0	K20TT	IK20TT	IK20TT	4
1.8 T	110/132	AGU; ARX; AUM; AUQ; BAE		05/00-05/05	PK20PR-P8	3245	0.8	-	IK20TT	IK20TT	4
1.9 SDI	50	AGP; AQM		10/98-05/05	DG-005		11V				4
1.9 TDI	66/81	AGR; AHF; ALH; ASV		10/98-05/05	DG-005		11V				4
1.9 TDI	74/85/96/110	AJM; ARL; ASZ; ATD; AUY; AXR	Ch: >1J-2-600 000	05/00-05/05	DG-005		11V				4
1.9 TDI	74/96/110	ARL; ASZ; ATD; AXR	Ch: 1J-2-600 001>	05/00-05/05	DG-109		11V				4
1.9 TDI 4motion	66	AGR		11/98-04/02	DG-005		11V				4
1.9 TDI 4motion	74/96/110	ARL; ASZ; ATD	Ch: 1J-2-600 001>	05/00-05/05	DG-109		11V				4
1.9 TDI 4motion	74/85/96/110	AJM; ARL; ASZ; ATD; AUY	Ch: >1J-2-600 000	05/00-05/05	DG-005		11V				4
2.0	85	APK; AQY; AZG; AZH		10/98-05/05	K20PBR-S10	5061	1.0	K20TT	IK20TT	IK20TT	4
2.0	85	AZJ		10/98-05/05	PKJ16CR-L11	3246	1.1	-	IK16TT	IK16TT	4
2.0 4motion	85	AZH		04/00-05/05	K20PBR-S10	5061	1.0	K20TT	IK20TT	IK20TT	4
2.0 4motion	85/88	ATF; AZJ		12/99-05/05	PKJ16CR-L11	3246	1.1	-	IK16TT	IK16TT	4
2.3 V5	110	AGZ		10/98-10/00	K20TXR	5063	1.0	K20TT	IK20TT	IK20TT	5
2.3 V5	125	AQN		10/00-05/05	PKJ16CR-L11	3246	1.1	-	IK16TT	IK16TT	5
2.3 V5 4motion	110	AGZ		12/98-10/00	K20TXR	5063	1.0	K20TT	IK20TT	IK20TT	5
2.3 V5 4motion	125	AQN		10/00-05/05	PKJ16CR-L11	3246	1.1	-	IK16TT	IK16TT	5
2.8 V6 4motion	150	AQP; AUE; BDE		03/99-05/05	PKJ16CR-L11	3246	1.1	-	IK16TT	IK16TT	6
2.8 VR6	150	AUE		03/00-05/00	PKJ16CR-L11	3246	1.1	-	IK16TT	IK16TT	6
CADDY I (14) (82-92)											
1.5	51	JB		08/82-07/83	W16EPR-U	3021	0.8	W16TT	IW16TT	IW16TT	4
1.6	55	EM; EW		10/82-06/89	W16EPR-U	3021	0.8	W16TT	IW16TT	IW16TT	4
1.6	55	EW		01/83-07/92	W16EP-U	3018	0.8	W16TT	IW16TT	IW16TT	4
1.6 D	40	JK; ME		08/82-07/92	DG-012		11V				4
1.8	70	JH		08/85-07/92	W20EPB	5065	0.85	W20TT	IW20TT	IW20TT	4
CADDY II (9K, 9U) (95-04)											
1.4	55	AUA		08/00-01/04	K20PBR-S10	5061	1.0	K20TT	IK20TT	IK20TT	4
1.4	44	AUD		11/95-01/04	PKJ16CR-L11	3246	1.1	-	IK16TT	IK16TT	4
1.4 16V	55	AUA		08/00-01/04	K20PBR-S10	5061	1.0	K20TT	IK20TT	IK20TT	4
1.6	55	1F; AEE		11/95-09/00	W20EPBR-S	5067	0.85	W20TT	IW20TT	IW20TT	4
1.7 SDI	42	AHB		07/96-09/00	DG-005		11V				4
1.9 D	47	1Y; AEF		11/95-01/04	DG-012		11V				4
1.9 SDI	47	AEY; AYQ		11/95-01/04	DG-005		11V				4
1.9 TDI	66	1Z; AHU; ALE; ALH		09/96-01/04	DG-005		11V				4
60 1.4	44	AEX		11/95-01/04	W20EPBR-S	5067	0.85	W20TT	IW20TT	IW20TT	4
75 1.6	55	1F; AEE		11/95-09/00	W20EPBR-S	5067	0.85	W20TT	IW20TT	IW20TT	4
CADDY III (2K, 2C) (04-)											
1.4	55	BCA		03/04-05/06	K20PBR-S10	5061	1.0	K20TT	IK20TT	IK20TT	4
1.4 16V	59	BUD		05/06-08/10	KJ20DR-M11	3374	1.1	-	IK20TT	IK20TT	4
1.6	74/75	BGU; BSE; BSF		04/04-	K20PBR-S10	5061	1.0	K20TT	IK20TT	IK20TT	4
1.6 BiFuel	75	CHGA		05/11-	K20PBR-S10	5061	1.0	K20TT	IK20TT	IK20TT	4
1.6 TDI	55/75	CAYD; CAYE		08/10-	DG-193		4.4V				4
1.9 TDI	55/77	BJB; BLS; BSU		04/04-08/10	DG-177		5V				4
1.9 TDI 4motion	77	BLS		05/08-08/10	DG-177		5V				4
2.0 EcoFuel	80	BSX	Flexible fuel	04/06-08/10	VK20T	5501	0.8	-	IK20TT	IK20TT	4
2.0 SDI	51	BDJ; BST		03/04-08/10	DG-109		11V				4
2.0 TDI	103	BMM		09/07-08/10	DG-177		5V				4







	KW									QTY	
VW continued											
CADDY III (2K, 2C) (04-) continued											
2.0 TDI	62/81	CFHE; CLCA		08/10-	DG-193		4.4V			4	
2.0 TDI 16V	103	CFHC; CLCB		11/10-	DG-193		4.4V			4	
2.0 TDI 16V 4motion	103	CFHC		11/10-	DG-193		4.4V			4	
2.0 TDI 4motion	62/81	CFHE; CFHF		08/10-	DG-193		4.4V			4	
CC (358) (11-)											
1.8 TSI	112/118	CDAA; CDAB		11/11-	PK22PR8	3273	0.8	-	-	VK22	4
2.0 TDI	100/103/125/130	CFFA; CFFB; CFGB; CFGC; CLLA		11/11-	DG-193		4.4V			4	
2.0 TDI 4motion	103/125/130	CFFB; CFGB; CFGC		11/11-	DG-193		4.4V			4	
2.0 TSI	147/155	CBFA; CCTA; CCZB		11/11-	PK22PR8	3273	0.8	-	-	VK22	4
CORRADO (53I) (88-95)											
1.8 16V	100	KR		04/89-07/92	K20PBR	5060	0.85	K20TT	IK20TT	IK20TT	4
1.8 G60	118	PG		09/88-09/93	P20PR11	3115	1.1	W20TT	IW20TT	IW20TT	4
2.0 i	85	ADY		04/93-12/95	W20EPBR-S	5067	0.85	W20TT	IW20TT	IW20TT	4
2.0 i 16V	100	9A		08/91-12/95	K22PBR-S	5062	0.85	-	-	VK22	4
2.9 VR6	140	ABV		08/91-12/95	K20TXR	5063	1.0	K20TT	IK20TT	IK20TT	6
CRAFTER 30-35 (2E, 2F) (06-)											
2.0 TDI	80/100/105/120	CKTB; CKTC; CKUB; CKUC; CSNA		05/11-	DG-193		4.4V			4	
2.0 TDI 4motion	120	CKUB; CSNA		11/11-	DG-193		4.4V			4	
2.5 TDI	65/80/100/120	BJJ; BJK; BJL; BJM; CEBA; CEBB; CECA; CECB		04/06-	DG-177		5V			5	
CRAFTER 30-50 (2E, 2F) (06-)											
2.0 TDI	80/100/105/120	CKTB; CKTC; CKUB; CKUC; CSNA		05/11-	DG-193		4.4V			4	
2.0 TDI 4motion	120	CKUB; CSNA		11/11-	DG-193		4.4V			4	
2.5 TDI	65/80/100/120	BJJ; BJK; BJL; BJM; CEBA; CEBB; CECA; CECB		04/06-	DG-177		5V			5	
DERBY (86) (77-81)											
0.9	29	HA		02/77-09/81	W20EP-U	3043	0.8	W20TT	IW20TT	IW20TT	4
1.1	37	HB		02/77-09/81	W20EP-U	3043	0.8	W20TT	IW20TT	IW20TT	4
1.3	43/44	HH; HJ		02/77-09/81	W20EP-U	3043	0.8	W20TT	IW20TT	IW20TT	4
DERBY (86C, 80) (81-84)											
1.0	29/33	GL; HZ		08/81-12/84	W20EP-U	3043	0.8	W20TT	IW20TT	IW20TT	4
1.1	37	HB		10/81-07/83	W20EP-U	3043	0.8	W20TT	IW20TT	IW20TT	4
1.3	40/44	HH; HK		08/81-12/84	W20EP-U	3043	0.8	W20TT	IW20TT	IW20TT	4
1.3	55	GK		09/82-12/84	W22EPR-U	3088	0.8	W22TT	-	VW22	4
EOS (1F) (06-)											
1.4 TSI	90	CAXA		11/07-	PKJ20CR8	3173	0.8	-	-	VK20G	4
1.6 FSI	85	BLF		06/06-05/08	K20PR-U	3145	0.8	K20TT	IK20TT	IK20TT	4
1.6 FSI	85	BLF	OEM Optional	06/06-05/08	VKA16	5622	1.1	-	-	VKA16	4
2.0 FSI	110	BVZ		03/06-05/08	K20PR-U	3145	0.8	K20TT	IK20TT	IK20TT	4
2.0 FSI	110	BVY		03/06-05/08	VKA16	5622	1.1	-	-	VKA16	4
2.0 TDI	103	BMM		06/06-05/08	DG-177		5V			4	
2.0 TDI	100	CFFA		11/10-	DG-193		4.4V			4	
2.0 TDI 16V	103	CBAB; CFFB		05/08-	DG-193		4.4V			4	
2.0 TFSI	147	BPY; BWA; CAWB; CCZA		03/06-	PK22PR8	3273	0.8	-	-	VK22	4
2.0 TSI	155	CCZB		11/09-	PK22PR8	3273	0.8	-	-	VK22	4
FOX (5Z) (03-)											
1.2	40	BMD		04/05-	KJ16CR-L11	3132	1.1	K16TT	IK16TT	IK16TT	3
1.2	44	CHFA		09/10-	KJ20DR-M11	3374	1.1	-	IK20TT	IK20TT	3
1.4	55	BKR		04/05-	PKJ16CR-L11	3246	1.1	-	IK16TT	IK16TT	4
1.4 TDI	51	BNM		04/05-	DG-109		11V			3	
GOLF I (17, 155) (74-93)											
1.1	37/38	FA; FJ		04/74-07/83	W20EP-U	3043	0.8	W20TT	IW20TT	IW20TT	4
1.3	40/43/44	GF; GS; HK		08/79-07/86	W20EP-U	3043	0.8	W20TT	IW20TT	IW20TT	4
1.5	51	GH; JB		01/79-11/83	W16EPR-U	3021	0.8	W16TT	IW16TT	IW16TT	4

Spark & Glow Plugs

Application Tables











	KW					Standard		Twin Tip		QTY	
VW continued											
GOLF I (17, 155) (74-93) continued											
1.5	51	JB		08/77-07/83	W16EP-U	3018	0.8	W16TT	IW16TT	IW16TT	4
1.5	51	FH		04/74-12/75	W20EPR-U	3047	0.8	W20TT	IW20TT	IW20TT	4
1.5 D	37	CK		08/76-07/80	DG-012		11V				4
1.6	55	EW; HN		01/83-04/92	W16EP-U	3018	0.8	W16TT	IW16TT	IW16TT	4
1.6	53	RE		04/86-02/90	W20EPBR-S	5067	0.85	W20TT	IW20TT	IW20TT	4
1.6	51	FV		08/75-07/77	W20EPR-U	3047	0.8	W20TT	IW20TT	IW20TT	4
1.6	55	EM		08/75-02/84	W20EP-U	3043	0.8	W20TT	IW20TT	IW20TT	4
1.6	81	EG		08/81-07/82	W22EPR-U	3088	0.8	W22TT	-	VW22	4
1.6	81	EG		08/79-07/82	W22EP-U	3085	0.8	W22TT	-	VW22	4
1.6	55	EZ	Ch: >F-350 000	01/83-02/84	W16EPR-U	3021	0.8	W16TT	IW16TT	IW16TT	4
1.6 D	40	CR; JK		08/80-07/83	DG-012		11V				4
1.6 GTI	81	EG		08/76-07/82	W22EPR-U	3088	0.8	W22TT	-	VW22	4
1.6 TD	51	CY		03/82-07/83	DG-012		11V				4
1.8	82	DX		08/82-07/88	W16EPR-U	3021	0.8	W16TT	IW16TT	IW16TT	4
1.8	66/ 70/ 72/ 82	2H; DX; EX; JH		08/83-12/92	W20EPB	5065	0.85	W20TT	IW20TT	IW20TT	4
1.8 GTI	82	JJ		08/82-12/83	W20EPB	5065	0.85	W20TT	IW20TT	IW20TT	4
GOLF II (19, 1G) (83-92)											
1.0	33	GN		11/83-08/85	W20EPR-U	3047	0.8	W20TT	IW20TT	IW20TT	4
1.0	37	HZ		08/85-10/91	W20EP-U	3043	0.8	W20TT	IW20TT	IW20TT	4
1.3	37	NU		08/85-12/87	W20EPB	5065	0.85	W20TT	IW20TT	IW20TT	4
1.3	40/43	GT; HK		08/83-06/87	W20EP-U	3043	0.8	W20TT	IW20TT	IW20TT	4
1.3 CAT	40	2G		06/86-12/92	W20EPB	5065	0.85	W20TT	IW20TT	IW20TT	4
1.6	51/ 53/ 55	ABN; PN; RF		08/83-12/92	W20EPB	5065	0.85	W20TT	IW20TT	IW20TT	4
1.6 D	40	JP; ME		08/83-10/91	DG-012		11V				4
1.6 TD	44/ 51/ 59	1V; JR; MF; RA; SB		04/89-10/91	DG-012		11V				4
1.8	62/66	GU; RH		08/84-10/91	W20EPB	5065	0.85	W20TT	IW20TT	IW20TT	4
1.8 GTI	77/82	HT; PB		08/83-10/91	W20EPB	5065	0.85	W20TT	IW20TT	IW20TT	4
1.8 GTI	79	RD		08/85-10/87	W20EPBR-S	5067	0.85	W20TT	IW20TT	IW20TT	4
1.8 GTI 16V	95/ 102	KR; PL		02/86-10/91	K22PBR-S	5062	0.85	-	-	VK22	4
1.8 GTI CAT	79	PF		01/87-10/91	W20EPB	5065	0.85	W20TT	IW20TT	IW20TT	4
1.8 GTI G60	118	PG		04/90-07/91	P20PR11	3115	1.1	W20TT	IW20TT	IW20TT	4
1.8 GTI G60 Syncro	118	1H; PG		08/88-12/91	IW20	5306	1.1	-	IW20TT	IW20TT	4
1.8 i CAT	66	RP		08/87-10/91	W20EPB	5065	0.85	W20TT	IW20TT	IW20TT	4
1.8 i Syncro CAT	66	RP		08/87-10/91	W20EPBR-S	5067	0.85	W20TT	IW20TT	IW20TT	4
1.8 Syncro	66	GU		02/86-07/91	W20EPB	5065	0.85	W20TT	IW20TT	IW20TT	4
1.8 Syncro	72	1P		08/88-07/91	W20EP-U	3043	0.8	W20TT	IW20TT	IW20TT	4
GOLF III (1H, 1E) (91-99)											
1.4	40	ABD; AEX		11/91-08/97	W20EPB	5065	0.85	W20TT	IW20TT	IW20TT	4
1.4	40/44	ABD; AEX; APQ		07/93-04/99	W20EPBR-S	5067	0.85	W20TT	IW20TT	IW20TT	4
1.6	74	AEK; AFT		07/94-04/99	K20PBR-S10	5061	1.0	K20TT	IK20TT	IK20TT	4
1.6	55	ABU; AEA; AEE		09/92-08/97	W20EPBR-S	5067	0.85	W20TT	IW20TT	IW20TT	4
1.8	55	AAM		07/93-04/99	W16ETR-S	3285	1.0	W16TT	IW16TT	IW16TT	4
1.8	55/66	AAM; ADZ		11/91-08/97	W20EPBR-S	5067	0.85	W20TT	IW20TT	IW20TT	4
1.8 Syncro	66	ADZ		10/94-04/99	W20EPBR-S	5067	0.85	W20TT	IW20TT	IW20TT	4
1.8 Syncro (1HX1)	66	ABS		01/93-08/97	W20EPBR-S	5067	0.85	W20TT	IW20TT	IW20TT	4
1.9 D	48	1Y		11/91-04/99	DG-012		11V				4
1.9 SDI	47	AEY		07/95-04/99	DG-005		11V				4
1.9 TD	55	AAZ		07/93-04/99	DG-012		11V				4
1.9 TD,GTD	55	AAZ		11/91-08/97	DG-012		11V				4
1.9 TDI	66/81	1Z; AFN; AHU; ALE		03/94-04/99	DG-005		11V				4
1.9 TDI Syncro	66	1Z; AHU; ALE		07/95-04/99	DG-005		11V				4
1.9 TDI Syncro (1HX1)	66	1Z; AHU; ALE		08/95-08/97	DG-005		11V				4
2.0	85	AGG		11/91-04/99	W20EPBR-S	5067	0.85	W20TT	IW20TT	IW20TT	4
2.0 GL	79	AEP		08/95-09/97	W20EPBR-S	5067	0.85	W20TT	IW20TT	IW20TT	4
2.0 GTI 16V	110	ABF		08/92-08/97	PK22PR8	3273	0.8	-	-	VK22	4
2.0 Syncro	85	AGG		08/95-04/99	W20EPBR-S	5067	0.85	W20TT	IW20TT	IW20TT	4
2.0 Syncro (1HX1)	85	AGG		08/95-08/97	W20EPBR-S	5067	0.85	W20TT	IW20TT	IW20TT	4
2.8 VR6	120/ 128	AAA		01/92-09/97	K20TXR	5063	1.0	K20TT	IK20TT	IK20TT	6
2.9 VR6	140	ABV		10/94-04/99	K20TXR	5063	1.0	K20TT	IK20TT	IK20TT	6
2.9 VR6 Syncro	140	ABV		10/94-04/99	K20TXR	5063	1.0	K20TT	IK20TT	IK20TT	6







	KW				Standard			Twin Tip				QTY
VW continued												
GOLF III (1H, 1E) (91-99) continued												
2.9 VR6 Syncro (1HX1)	140	ABV		10/94-08/97	K20TXR	5063	1.0	K20TT	IK20TT	IK20TT		6
GOLF IV (1J, 1E) (97-06)												
1.4 16V	55	AKQ; APE		05/99-06/06	K20PBR-S10	5061	1.0	K20TT	IK20TT	IK20TT		4
1.6	74/ 75/ 78	AEH; AFT; AKL; AKS; APF; AVU; AWB; BAH; BFQ; BJH		05/99-06/05	K20PBR-S10	5061	1.0	K20TT	IK20TT	IK20TT		4
1.6 16V	77	ATN; AUS		02/00-06/06	K20PBR-S10	5061	1.0	K20TT	IK20TT	IK20TT		4
1.6 16V	77	AZD; BCB		02/00-06/06	PKJ16CR-L11	3246	1.1	-	IK16TT	IK16TT		4
1.6 FSI	81	BAD		01/02-06/06	K20PBR-S10	5061	1.0	K20TT	IK20TT	IK20TT		4
1.8	92	AGN		08/97-06/05	K20PBR-S10	5061	1.0	K20TT	IK20TT	IK20TT		4
1.8	55	AAM		06/98-06/02	W16ETR-S	3285	1.0	W16TT	IW16TT	IW16TT		4
1.8	66	ADZ		06/98-06/02	W20EPBR-S	5067	0.85	W20TT	IW20TT	IW20TT		4
1.8 4motion	92	AGN		05/98-06/06	K20PBR-S10	5061	1.0	K20TT	IK20TT	IK20TT		4
1.8 T	110	AGU		08/97-06/06	PK20PR-P8	3245	0.8	-	IK20TT	IK20TT		4
1.8 T GTI	132	AUQ		08/01-06/05	PK20PR-P8	3245	0.8	-	IK20TT	IK20TT		4
1.9 SDI	50	AGP; AQM		08/97-06/06	DG-005		11V					4
1.9 TDI	66/81	AFN; AGR; AHF; AHU; ALE; ALH; ASV		08/97-05/06	DG-005		11V					4
1.9 TDI	74/ 85/ 96/ 110	AJM; ARL; ASZ; ATD; AUY; AXR	Ch: >1J-2-545 141	05/00-06/06	DG-005		11V					4
1.9 TDI	74/ 96/ 110	ARL; ASZ; ATD; AXR	Ch: 1J-2-545 142>	05/00-06/06	DG-109		11V					4
1.9 TDI 4motion	66	AGR		07/98-04/02	DG-005		11V					4
1.9 TDI 4motion	74/ 85/ 96/ 110	AJM; ARL; ASZ; ATD; AUY	Ch: >1J-2-545 141	02/00-06/06	DG-005		11V					4
1.9 TDI 4motion	74/ 96/ 110	ARL; ASZ; ATD	Ch: 1J-2-545 142>	02/00-06/06	DG-109		11V					4
2.0	85	APK; AQY		07/98-06/06	K20PBR-S10	5061	1.0	K20TT	IK20TT	IK20TT		4
2.0	85	ATU; AWF; AWG		06/98-06/02	PK20PR-P8	3245	0.8	-	IK20TT	IK20TT		4
2.0	85	AZG; AZJ		07/98-06/06	PKJ16CR-L11	3246	1.1	-	IK16TT	IK16TT		4
2.0	85	AGG; AKR		06/98-06/02	W20EPBR-S	5067	0.85	W20TT	IW20TT	IW20TT		4
2.0 4motion	85	AZH		10/00-06/06	K20PBR-S10	5061	1.0	K20TT	IK20TT	IK20TT		4
2.0 4motion	85/88	ATF; AZJ		12/99-06/06	PKJ16CR-L11	3246	1.1	-	IK16TT	IK16TT		4
2.0 Bi-Fuel	85	BEH	Flexible fuel	02/02-06/06	PKJ16CR-L11	3246	1.1	-	IK16TT	IK16TT		4
2.3 V5	110	AGZ		08/97-06/06	K20TXR	5063	1.0	K20TT	IK20TT	IK20TT		5
2.3 V5	125	AQN		10/00-06/06	PKJ16CR-L11	3246	1.1	-	IK16TT	IK16TT		5
2.3 V5 4motion	110	AGZ		12/98-06/06	K20TXR	5063	1.0	K20TT	IK20TT	IK20TT		5
2.3 V5 4motion	125	AQN		10/00-06/06	PKJ16CR-L11	3246	1.1	-	IK16TT	IK16TT		5
2.8 V6 4motion	150	AQP; BDE		03/99-06/06	PKJ16CR-L11	3246	1.1	-	IK16TT	IK16TT		6
GOLF PLUS (5M, 521) (05-)												
1.4 16V	55	BCA		01/05-05/06	K20PBR-S10	5061	1.0	K20TT	IK20TT	IK20TT		4
1.4 16V	59	BUD; CGGA		05/06-	KJ20DR-M11	3374	1.1	-	IK20TT	IK20TT		4
1.4 FSI	66	BLN		07/05-05/06	K20PBR-S10	5061	1.0	K20TT	IK20TT	IK20TT		4
1.4 TSI	90/ 103/ 125	BLG; BMY; CAXA		05/06-	PKJ20CR8	3173	0.8	-	-	VK20G		4
1.6	75	BSE - E5		05/05-	K20PBR-S10	5061	1.0	K20TT	IK20TT	IK20TT		4
1.6 BiFuel	75	CHGA		05/09-	K20PBR-S10	5061	1.0	K20TT	IK20TT	IK20TT		4
1.6 FSI	85	BLF		01/05-05/08	K20PBR-S10	5061	1.0	K20TT	IK20TT	IK20TT		4
1.6 MultiFuel	75	CHGA	Flexible fuel	05/09-	K20PBR-S10	5061	1.0	K20TT	IK20TT	IK20TT		4
1.6 TDI	66/77	CAYB; CAYC		02/09-	DG-193		4.4V					4
1.9 TDI	66/77	BKC; BLS; BRU; BXE; BXF; BXJ		01/05-01/09	DG-177		5V					4
2.0 FSI	110	BLY; BVZ		05/05-06/08	K20PR-U	3145	0.8	K20TT	IK20TT	IK20TT		4
2.0 FSI	110	BLR; BVY		05/05-06/08	VKA16	5622	1.1	-	-	VKA16		4
2.0 TDI	103	BMM		12/05-05/09	DG-177		5V					4
2.0 TDI	96/ 100	AZV; BEE		05/05-	DG-190		4.4V					4
2.0 TDI	81/ 100	CBDA; CBDC; CFHB; CLCA		05/05-	DG-193		4.4V					4
2.0 TDI 16V	103	BKD		01/05-	DG-190		4.4V					4
2.0 TDI 16V	103	CBDB; CFHC		01/05-	DG-193		4.4V					4
GOLF V (1K) (03-09)												
1.4	59	BUD		06/07-07/09	KJ20DR-M11	3374	1.1	-	IK20TT	IK20TT		4
1.4 16V	55	BCA		10/03-05/06	K20PBR-S10	5061	1.0	K20TT	IK20TT	IK20TT		4
1.4 16V	59	BUD		05/06-11/08	KJ20DR-M11	3374	1.1	-	IK20TT	IK20TT		4

	KW					Standard		Twin Tip		QTY	
VW continued											
GOLF V (1K) (03-09) continued											
1.4 FSI	66	BKG; BLN		10/03-05/05	K20PBR-S10	5061	1.0	K20TT	IK20TT	IK20TT	4
1.4 FSI	66	BLN		06/05-07/06	VK22	5610	0.8	-	-	VK22	4
1.4 TSI	90/ 103/ 118/ 125	BLG; BMY; CAVD; CAXA		05/06-11/08	PKJ20CR8	3173	0.8	-	-	VK20G	4
1.6	75	BGU; BSE; BSF; CCSA		01/04-07/09	K20PBR-S10	5061	1.0	K20TT	IK20TT	IK20TT	4
1.6 FSI	85	BAG; BLF; BLP		10/03-07/08	K20PBR-S10	5061	1.0	K20TT	IK20TT	IK20TT	4
1.6 MultiFuel	75	CCSA		10/07-07/09	K20PBR-S10	5061	1.0	K20TT	IK20TT	IK20TT	4
1.9 TDI	66/77	BKG; BLS; BRU; BXE; BXF; BXJ		05/04-07/09	DG-177		5V				4
1.9 TDI 4motion	77	BKG; BLS; BXE		08/04-07/09	DG-177		5V				4
2.0	147	BWA		06/07-03/09	PK22PR8	3273	0.8	-	-	VK22	4
2.0 FSI	110	BVZ		01/04-11/08	K20PR-U	3145	0.8	K20TT	IK20TT	IK20TT	4
2.0 FSI	110	AXW; BLR; BLX; BLY; BVX; BVY; BVZ		01/04-11/08	VKA16	5622	1.1	-	-	VKA16	4
2.0 FSI 4motion	110	BLX; BVX		08/04-05/07	VKA16	5622	1.1	-	-	VKA16	4
2.0 GTI	169	BYD		09/06-12/08	K20PR-U	3145	0.8	K20TT	IK20TT	IK20TT	4
2.0 GTI	147	AXX; BWA		10/04-02/09	PK22PR8	3273	0.8	-	-	VK22	4
2.0 SDI	55	BDK		01/04-11/08	DG-177		5V				4
2.0 TDI	103/ 125	BMM; BMN		11/05-07/09	DG-177		5V				4
2.0 TDI	100	AZV		10/03-07/09	DG-190		4.4V				4
2.0 TDI	100	CBDA		10/03-11/08	DG-193		4.4V				4
2.0 TDI 16V	103	BKD		10/03-07/09	DG-190		4.4V				4
2.0 TDI 16V	103	CBDB		06/07-07/09	DG-193		4.4V				4
2.0 TDI 16V 4motion	103	BKD		08/04-11/08	DG-190		4.4V				4
2.0 TDI 4motion	103	BMM		08/04-11/08	DG-177		5V				4
2.0 TDI 4motion	100	AZV		06/07-07/09	DG-190		4.4V				4
GOLF VI (5K, 517, AJ5) (08-)											
1.4	59	BUD; CGGA		10/08-07/13	KJ20DR-M11	3374	1.1	-	IK20TT	IK20TT	4
1.4 TSI	90/ 118	CAVD; CAXA; CNWA; CTHD; CTKA		03/11-	PKJ20CR8	3173	0.8	-	-	VK20G	4
1.6	75	BSE - E5; BSE		10/08-07/13	K20PBR-S10	5061	1.0	K20TT	IK20TT	IK20TT	4
1.6 BiFuel	75	CHGA		03/09-11/12	K20PBR-S10	5061	1.0	K20TT	IK20TT	IK20TT	4
1.6 MultiFuel	75	CCSA; CMXA		10/08-07/13	K20PBR-S10	5061	1.0	K20TT	IK20TT	IK20TT	4
1.6 TDI	66/77	CAYB; CAYC		02/09-07/13	DG-193		4.4V				4
1.6 TDI 4motion	77	CAYC		07/09-07/13	DG-193		4.4V				4
1.8 TSI	118	CDAA		06/09-01/11	PK22PR8	3273	0.8	-	-	VK22	4
2.0 GTi	147/ 155	CBFA; CCTA; CCZA; CCZB		06/09-	PK22PR8	3273	0.8	-	-	VK22	4
2.0 GTi	173	CDLG		05/11-11/12	VK22	5610	0.8	-	-	VK22	4
2.0 R	195	CDLA		01/13-	PK22PR8	3273	0.8	-	-	VK22	4
2.0 R 4motion	188/ 195/ 199	CDLA; CDLC; CDLF; CRZA		11/09-11/13	PK22PR8	3273	0.8	-	-	VK22	4
2.0 TDI	103	BMM		07/09-07/13	DG-177		5V				4
2.0 TDI	81/ 100/ 103/ 125	CBAA; CBAB; CBBB; CBDA; CBDC; CFFA; CFFB; CFGB; CFHB; CFHC; CLCA		10/08-07/13	DG-193		4.4V				4
2.0 TDI 16V	103	CBDB; CFHC; CJAA; CLCB		07/09-07/13	DG-193		4.4V				4
2.0 TDI 4motion	103	CBAB; CFFB		05/09-11/12	DG-193		4.4V				4
2.0 TSI	147/ 162	CBFA; CCTA; CCZA; CULC		07/09-	PK22PR8	3273	0.8	-	-	VK22	4
GOLF VII (5G, BA5) (12-)											
1.6 TDI	66/ 77/ 81	CLHA; CLHB; CRKA; CRKB; CXXB		04/13-	DG-193		4.4V				4
1.6 TDI 4motion	77/81	CLHA; CRKB		01/13-	DG-193		4.4V				3
2.0 GTD	135	CUNA		04/13-	DG-193		4.4V				4
2.0 TDI	110	CRBC;CRLB;CRVA; CRBC;CRLB		11/12-	DG-193		4.4V				3
2.0 TDI 4motion	110	CRBC;CRLB		11/12-	DG-193		4.4V				3
ILTIS (79-88)											
1.7	55	YX		03/79-12/88	W20EP-U	3043	0.8	W20TT	IW20TT	IW20TT	4
JETTA I (16) (78-84)											
1.1	37	FA		08/78-02/84	W20EP-U	3043	0.8	W20TT	IW20TT	IW20TT	4
1.3	43/44	GF; GS		08/79-02/84	W20EP-U	3043	0.8	W20TT	IW20TT	IW20TT	4
1.5	51	GH; JB		08/78-02/84	W16EPR-U	3021	0.8	W16TT	IW16TT	IW16TT	4

Spark & Glow Plugs











Application Tables







	KW										QTY
VW continued											
JETTA I (16) (78-84) continued											
1.5	51	JB		08/78-02/84	W16EP-U	3018	0.8	W16TT	IW16TT	IW16TT	4
1.5 D	37	CK		08/78-07/80	DG-012		11V				4
1.6	55/63	EM; FR		08/78-02/84	W20EP-U	3043	0.8	W20TT	IW20TT	IW20TT	4
1.6 D	40	CR; JK		08/80-02/84	DG-012		11V				4
1.6 GLI	81	EG		08/78-07/82	W22EPR-U	3088	0.8	W22TT	-	VW22	4
1.6 TD	51	CY		03/82-02/84	DG-012		11V				4
1.8	82	DX; JJ		08/82-02/84	W22EPR-U	3088	0.8	W22TT	-	VW22	4
JETTA II (19, 1G) (84-92)											
1.3	40/43	GT; HK		01/84-06/87	W20EP-U	3043	0.8	W20TT	IW20TT	IW20TT	4
1.3 CAT	40	NZ		06/87-12/91	W20EP-U	3043	0.8	W20TT	IW20TT	IW20TT	4
1.6	51/ 53/ 55	ABN; PN; RF		01/84-07/92	W20EPB	5065	0.85	W20TT	IW20TT	IW20TT	4
1.6 D	40	JP; ME		01/84-10/91	DG-012		11V				4
1.6 TD	44/ 51/ 59	1V; JR; MF; RA; SB		04/89-10/91	DG-012		11V				4
1.8	62/ 66/ 82	GU; GZ; RH		01/84-10/91	W20EPB	5065	0.85	W20TT	IW20TT	IW20TT	4
1.8	79	RD		08/85-10/87	W20EPBR-S	5067	0.85	W20TT	IW20TT	IW20TT	4
1.8 16V	95/ 102	KR; PL		08/86-10/91	K22PBR-S	5062	0.85	-	-	VK22	4
1.8 CAT	66/79	PF; RP		01/87-10/91	W20EPB	5065	0.85	W20TT	IW20TT	IW20TT	4
1.8 Syncro	66/72	1P; RP		08/87-07/91	W20EPB	5065	0.85	W20TT	IW20TT	IW20TT	4
JETTA III (1K2) (05-10)											
1.4 TSI	90/ 103/ 118/ 125	BLG; BMY; CAVD; CAXA		07/06-10/10	PKJ20CR8	3173	0.8	-	-	VK20G	4
1.6	75	BSE; BSF		10/05-10/10	K20PBR-S10	5061	1.0	K20TT	IK20TT	IK20TT	4
1.6 FSI	85	BLF		09/05-06/08	K20PBR-S10	5061	1.0	K20TT	IK20TT	IK20TT	4
1.6 MultiFuel	75	CCSA		01/08-10/10	K20PBR-S10	5061	1.0	K20TT	IK20TT	IK20TT	4
1.6 TDI	66/77	CAYB; CAYC		06/09-10/10	DG-193		4.4V				4
1.9 TDI	77	BKC; BLS; BXE		08/05-10/10	DG-177		5V				4
2.0 FSI	110	BLY; BVZ		08/05-10/10	K20PBR-U	3145	0.8	K20TT	IK20TT	IK20TT	4
2.0 FSI	110	BLR; BVY		08/05-10/10	VKA16	5622	1.1	-	-	VKA16	4
2.0 TDI	103	BMM		10/05-10/10	DG-177		5V				4
2.0 TDI	100	AZV		09/05-10/10	DG-190		4.4V				4
2.0 TDI	100/ 125	CBDA; CEGA		09/05-10/10	DG-193		4.4V				4
2.0 TDI 16V	103	BKD		08/05-10/10	DG-190		4.4V				4
2.0 TDI 16V	103	CBDB		08/05-10/10	DG-193		4.4V				4
2.0 TFSI	147	BPY; BWA; CCTA		10/05-10/10	PK22PR8	3273	0.8	-	-	VK22	4
2.5 FSI	125	CBTA; CCCA - E4		07/08-10/10	KJ20DR-M11	3374	1.1	-	IK20TT	IK20TT	5
2.5 FSI	110	BTK		01/06-06/07	SKJ16CR-L11	3396	1.1	-	IK16TT	IK16TT	5
2.5 FSI	125	CBTA; CCCA - E4	OEM Optional	07/08-10/10	SKJ16CR-L11	3396	1.1	-	IK16TT	IK16TT	5
JETTA IV (162) (10-)											
1.4 TSI	90	CAXA; CMSB		05/11-	PKJ20CR8	3173	0.8	-	-	VK20G	4
1.6 TDI	77	CAYC		02/11-	DG-193		4.4V				4
2.0	85	CBPA		06/10-	KJ20DR-M11	3374	1.1	-	IK20TT	IK20TT	4
2.0 TDI	81/ 103	CFFB; CFHC; CLCA; CLCB		10/10-	DG-193		4.4V				4
2.0 TSI	147	CBFA; CCTA; CCZA		12/10-	PK22PR8	3273	0.8	-	-	VK22	4
2.5 FSI	125	CBTA		04/10-	KJ20DR-M11	3374	1.1	-	IK20TT	IK20TT	5
K 70 (70-74)											
1.6	55/66	DA; DB		08/70-10/74	W20EP-U	3043	0.8	W20TT	IW20TT	IW20TT	4
1.8	74	DC		08/73-10/74	W20EP-U	3043	0.8	W20TT	IW20TT	IW20TT	4
KAEFER (47-03)											
1.2 (42005)	22	M51		01/54-07/65	W16FSR	3033	0.7	-	-	-	4
1200 1.2 (11)	25	D		01/60-12/85	W16FSR	3033	0.7	-	-	-	4
1300 1.3	27	E		08/65-07/70	W16FS-U	3034	0.7	-	-	-	4
1300 1.3 (11)	29/32	AB; F		01/65-01/73	W16FS-U	3034	0.7	-	-	-	4
1302 1.2 (11)	25	D		08/69-08/72	W16FSR	3033	0.7	-	-	-	4
1302 1.3	29	AC		08/70-07/75	W16FS-U	3034	0.7	-	-	-	4
1302 1.3 (11)	32	AB		08/70-08/72	W16FS-U	3034	0.7	-	-	-	4
1302 1.6	34/35	AE; AF; AH; AK		08/70-07/74	W16FS-U	3034	0.7	-	-	-	4
1302 1.6 (11)	37	AD		01/70-08/72	W16FS-U	3034	0.7	-	-	-	4
1302,1303 1.6	37	AS		08/73-06/79	W16FSR	3033	0.7	-	-	-	4
1303 1.2	25	D		04/75-12/79	W16FSR	3033	0.7	-	-	-	4
1303 1.2 (13)	25	D		07/72-02/76	W16FSR	3033	0.7	-	-	-	4

	KW					Standard		Twin Tip		QTY
VW continued										
KAEFER (47-03) continued										
1303 1.3	32	AB		07/70-03/81	W16FS-U	3034	0.7	-	-	4
1303 1.3 (13)	32	AB; AR		08/72-07/75	W16FS-U	3034	0.7	-	-	4
1303 1.6	35	AE; AH; AK		08/70-07/74	W16FS-U	3034	0.7	-	-	4
1303 1.6 (13)	35	AD		08/72-12/79	W16FSR	3033	0.7	-	-	4
1303 LS,S 1.6 (13)	37	AD; AJ; AS		08/72-12/79	W16FSR	3033	0.7	-	-	4
1500 1.5	32	H		01/66-12/70	W16FS-U	3034	0.7	-	-	4
1500 1.5 (11)	32	H		08/66-11/73	W16FS-U	3034	0.7	-	-	4
1500 1.6	35/37	AD; B		07/69-01/73	W16FS-U	3034	0.7	-	-	4
1600 (Mexico)	34	AF		05/73-09/92	W16FSR	3033	0.7	-	-	4
1600 i (Mexico)	34	ACD		10/92-07/03	W16FSR	3033	0.7	-	-	4
Karmann 1.3	29	F		07/64-07/70	W16FS-U	3034	0.7	-	-	4
KARMANN GHIA (55-74)										
1200	25	D		09/57-12/64	W16FSR	3033	0.7	-	-	4
1500	32/33	H		01/66-12/69	W16FSR	3033	0.7	-	-	4
1500	40			08/61-05/70	W20FSR-U	6053	0.7	WF20TT	-	4
1600	35/37	AD; AL		01/70-07/74	W16FSR	3033	0.7	-	-	4
LT 28-35 I (281-363) (75-96)										
2.0	55	CH		04/75-09/83	W20EP-U	3043	0.8	W20TT	IW20TT	4
2.4	66	DL		12/82-07/92	W20EP-U	3043	0.8	W20TT	IW20TT	6
2.4 D	51/55	1S; ACT; DW		07/90-05/96	DG-012		11V			6
2.4 D	55	CP; DW	Ch: 28-B-000 001>	12/78-07/92	DG-012		11V			6
2.4 D Syncro	51/55	1S; DW		08/91-07/92	DG-012		11V			6
2.4 i	69	1E		03/94-06/96	W20EPR-U	3047	0.8	W20TT	IW20TT	6
2.4 i	69	1E		08/89-06/96	W20EP-U	3043	0.8	W20TT	IW20TT	6
2.4 Syncro	66	DL		08/91-07/92	W20EP-U	3043	0.8	W20TT	IW20TT	6
2.4 TD	68/ 70/ 75	1G; ACL; DV		12/82-09/93	DG-012		11V			6
2.4 TD Syncro	68/ 70/ 75	1G; ACL; DV		08/91-07/92	DG-012		11V			6
2.7 D	48	CG		11/75-01/80	DG-012		11V			4
LT 28-35 II (2D) (96-06)										
2.5 SDI	55	AGX		07/96-07/06	DG-005		11V			5
2.5 TDI	61/ 66/ 70/ 75/ 80	AHD; ANJ; APA; AVR; BBE; BBF		05/99-07/06	DG-005		11V			5
2.8 TDi	92/96	AGK; ATA		02/97-01/02	DG-139		11V			4
2.8 TDi	116	AUH; BCQ		05/01-06/06	DG-183		11.5V			4
LT 28-46 II (2D) (96-06)										
2.5 SDI	55	AGX		09/96-07/06	DG-005		11V			5
2.5 TDI	61/ 66/ 70/ 75/ 80	AHD; ANJ; APA; AVR; BBE; BBF		05/01-07/06	DG-005		11V			5
2.8 TDI	92/96	AGK; ATA		06/97-07/06	DG-139		11V			4
2.8 TDI	116	AUH; BCQ		04/02-07/06	DG-183		11.5V			4
LT 40-55 I (75-96)										
2.0	55	CH		04/75-09/83	W20EP-U	3043	0.8	W20TT	IW20TT	4
2.4	66	DL		12/82-07/92	W20EP-U	3043	0.8	W20TT	IW20TT	6
2.4 4WD	66	DL		12/82-07/92	W20EP-U	3043	0.8	W20TT	IW20TT	6
2.4 D	51	1S; ACT		07/90-06/96	DG-012		11V			6
2.4 D	55	CP; DW	Ch: 28-B-000 001>	12/78-07/92	DG-012		11V			6
2.4 D 4WD	55	DW		01/79-03/86	DG-012		11V			6
2.4 i	69	1E		01/93-06/96	W20EP-U	3043	0.8	W20TT	IW20TT	6
2.4 Syncro	66	DL		12/82-07/89	W20EP-U	3043	0.8	W20TT	IW20TT	6
2.4 TD	68/ 70/ 75	1G; ACL; DV		12/82-09/93	DG-012		11V			6
2.4 TD 4WD	75	DV		08/78-07/92	DG-012		11V			6
LUPO (6X, 6E) (98-05)										
1.0	37	AHT		10/98-05/00	K20PBR-S10	5061	1.0	K20TT	IK20TT	4
1.0	37	ALD; ANV; AUC		09/98-05/03	PKJ16CR-L11	3246	1.1	-	IK16TT	4
1.0	37	AER; ALL		09/98-05/00	W20EPBR-S	5067	0.85	W20TT	IW20TT	4
1.2 TDI 3L	45	ANY; AYZ	Ch: >6X-2-005 000	07/99-07/05	DG-005		11V			3
1.2 TDI 3L	45	ANY; AYZ	Ch: 6X-2-005 001>	07/99-07/05	DG-109		11V			3

Spark & Glow Plugs



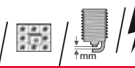



Application Tables







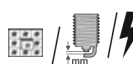

	KW										QTY
VW continued											
LUPO (6X, 6E) (98-05) continued											
1.4	44	AUD		10/00-05/03	PKJ16CR-L11	3246	1.1	-	IK16TT	IK16TT	4
1.4 16V	55/74	AFK; AHW; AKQ; APE; AQQ; AUA; AUB; BBY		09/98-07/05	K20PBR-S10	5061	1.0	K20TT	IK20TT	IK20TT	4
1.4 16V	74	AFK		08/99-10/00	W16EPB10	5064	1.0	W16TT	IW16TT	IW16TT	4
1.4 FSI	77	ARR		02/01-05/03	K20PBR-S10	5061	1.0	K20TT	IK20TT	IK20TT	4
1.4 TDI	55	AMF	Ch: >6X-2-005 000	01/99-07/05	DG-005		11V				3
1.4 TDI	55	AMF	Ch: 6X-2-005 001>	01/99-07/05	DG-109		11V				3
1.6 GTI	92	AVY		09/00-03/03	K20PBR-S10	5061	1.0	K20TT	IK20TT	IK20TT	4
1.7 SDI	44	AKU		09/98-07/05	DG-005		11V				4
MULTIVAN V (7H, 7E) (03-)											
1.9 TDI	63/77	AXB; AXC		04/03-11/09	DG-109		11V				4
1.9 TDI	62/75	BRR; BRS		01/06-11/09	DG-177		5V				4
2.0	85	AXA		11/03-	K20PBR-S10	5061	1.0	K20TT	IK20TT	IK20TT	4
2.0 BitDI	132	CFCA		09/09-	DG-193		4.4V				4
2.0 BitDI 4motion	132	CFCA		09/09-	DG-193		4.4V				4
2.0 TDI	62/ 75/ 84/ 100/ 103	CAAA; CAAB; CAAC; CAAD; CAAE; CCHA; CCHB		05/10-	DG-193		4.4V				4
2.0 TDI 4motion	100/ 103	CAAC; CAAE; CCHA; CCHB		09/09-	DG-193		4.4V				4
2.0 TSI	110/ 150	CJKA; CJKB		05/11-	PK22PR8	3273	0.8	-	-	VK22	4
2.0 TSI 4motion	150	CJKA		07/11-	PK22PR8	3273	0.8	-	-	VK22	4
2.5 TDI	96/ 120/ 128	AXD; AXE; BLJ		04/03-11/09	DG-109		11V				5
2.5 TDI 4motion	96/ 128	AXD; AXE		07/04-11/09	DG-109		11V				5
NEW BEETLE (9C, 1C, 1Y) (98-10)											
1.4	55	BCA		11/01-09/10	PKJ16CR-L11	3246	1.1	-	IK16TT	IK16TT	4
1.6	74/75	AWH; AYD; BFS		10/99-09/10	K20PBR-S10	5061	1.0	K20TT	IK20TT	IK20TT	4
1.6	75	AYD		06/00-05/01	PKJ16CR-L11	3246	1.1	-	IK16TT	IK16TT	4
1.8 T	110/ 132	AGU; APH; AVC; AWP; AWU; AWV; BKF		10/99-12/07	PK20PR-P8	3245	0.8	-	IK20TT	IK20TT	4
1.9 TDI	66	ALH		01/98-06/04	DG-005		11V				4
1.9 TDI	74/77	AXR; BSW		06/03-09/10	DG-109		11V				4
1.9 TDI	74	ATD	Ch: 9C-2-623 845>	02/01-09/10	DG-109		11V				4
2.0	85	AEG; APK; AQY; BEJ; BER; BEV; BHP		01/98-10/10	K20PBR-S10	5061	1.0	K20TT	IK20TT	IK20TT	4
2.0	85	AZG; AZJ; BDC; BGD		01/98-10/10	KJ16CR-L11	3132	1.1	K16TT	IK16TT	IK16TT	4
2.3 V5	125	AQN		10/00-06/05	PKJ16CR-L11	3246	1.1	-	IK16TT	IK16TT	5
2.5	110	BPR; BPS		07/05-09/10	SKJ16CR-L11	3396	1.1	-	IK16TT	IK16TT	5
RSI 3.2 4motion (1C9)	165	AXJ		04/00-05/01	PKJ16CR-L11	3246	1.1	-	IK16TT	IK16TT	6
PASSAT (3A2, 35I) (88-97)											
1.6	53	EZ		02/88-09/91	K20BR-S10	3330	1.0	K20TT	IK20TT	IK20TT	4
1.6	53/74	AEK; AFT; EZ		04/88-12/95	K20PBR-S10	5061	1.0	K20TT	IK20TT	IK20TT	4
1.6	55	EZ		02/88-12/88	W16EPR-U	3021	0.8	W16TT	IW16TT	IW16TT	4
1.6	53	1F		02/88-09/91	W20EPBR-S	5067	0.85	W20TT	IW20TT	IW20TT	4
1.6 TD	59	RA; SB		08/88-09/93	DG-012		11V				4
1.8	55	AAM		08/90-08/96	W16ETR-S	3285	1.0	W16TT	IW16TT	IW16TT	4
1.8	66/ 79/ 82	PB; PF; RP		02/88-08/96	W20EPB	5065	0.85	W20TT	IW20TT	IW20TT	4
1.8	55/66	AAM; ADZ		02/88-05/97	W20EPBR-S	5067	0.85	W20TT	IW20TT	IW20TT	4
1.8 16V	100	KR		04/88-12/89	K22PBR-S	5062	0.85	-	-	VK22	4
1.8 G60 Syncro	118	PG		08/88-05/97	P20PR11	3115	1.1	W20TT	IW20TT	IW20TT	4
1.9 D	50	1Y		05/89-10/93	DG-012		11V				4
1.9 TD	55	AAZ		03/91-05/97	DG-012		11V				4
1.9 TDI	66/81	1Z; AFN; AHU		10/93-05/97	DG-005		11V				4
2.0	79/85	AEP; AGG		02/90-08/96	W20EPBR-S	5067	0.85	W20TT	IW20TT	IW20TT	4
2.0 16V	110	ABF		01/94-05/97	IK22	5310	0.8	-	-	VK22	4
2.0 16V	100/ 110	9A; ABF		08/88-08/96	K22PBR-S	5062	0.85	-	-	VK22	4
2.0 Syncro	85	AGG		10/90-05/97	W20EPBR-S	5067	0.85	W20TT	IW20TT	IW20TT	4
2.8 VR6	128	AAA		06/91-05/97	K20TXR	5063	1.0	K20TT	IK20TT	IK20TT	6

	KW								QTY		
VW continued											
PASSAT (3A2, 35I) (88-97) continued											
2.9 VR6 Syncro	135	ABV		01/94-05/97	K20TXR	5063	1.0	K20TT	IK20TT	IK20TT	6
PASSAT (3B2, 3B5) (96-01)											
1.6	74	AHL		10/96-11/00	K20PBR-S10	5061	1.0	K20TT	IK20TT	IK20TT	4
1.8	85/92	ADR; AFY		10/96-11/00	K20PBR-S10	5061	1.0	K20TT	IK20TT	IK20TT	4
1.8 Syncro/4motion	92	ADR; APT		10/96-11/00	K20PBR-S10	5061	1.0	K20TT	IK20TT	IK20TT	4
1.8 T	110	AEB		10/96-11/00	PK20PR-P8	3245	0.8	-	IK20TT	IK20TT	4
1.9 TDI	66/ 81/ 85	AFN; AHH; AHU; AJM; ATJ; AVG		06/97-11/00	DG-005		11V				4
1.9 TDI	74	AVB	Ch: >3B-2-350 000	02/00-11/00	DG-005		11V				4
1.9 TDI	74	AVB	Ch: 3B-2-350 001>	02/00-11/00	DG-109		11V				4
1.9 TDI 4motion	85	ATJ		08/99-11/00	DG-005		11V				4
1.9 TDI Syncro/4motion	81	AFN; AVG		10/96-11/00	DG-005		11V				4
2.3 VR5	110	AGZ		10/96-11/00	K20TXR	5063	1.0	K20TT	IK20TT	IK20TT	5
2.3 VR5 Syncro/4motion	110	AGZ		10/97-11/00	K20TXR	5063	1.0	K20TT	IK20TT	IK20TT	5
2.5 TDI	110	AFB; AKN		07/98-11/00	DG-144		11V				6
2.5 TDI Syncro/4motion	110	AFB; AKN		12/98-11/00	DG-144		11V				6
2.8 V6	132/ 140/ 142	AGE; APR; ATX; BBG		08/96-11/00	K20TXR	5063	1.0	K20TT	IK20TT	IK20TT	6
2.8 V6 Syncro/4motion	142	APR		10/96-11/00	K20TXR	5063	1.0	K20TT	IK20TT	IK20TT	6
PASSAT (3B3, 3B6) (00-05)											
1.6	75	ALZ		11/00-05/05	K20PBR-S10	5061	1.0	K20TT	IK20TT	IK20TT	4
1.8 4motion	125	AWM		03/01-05/05	PK20PR-P8	3245	0.8	-	IK20TT	IK20TT	4
1.8 T	125	AWM		02/01-08/05	PK20PR-P8	3245	0.8	-	IK20TT	IK20TT	4
1.8 T 20V	110	AWT		11/00-05/05	PK20PR-P8	3245	0.8	-	IK20TT	IK20TT	4
1.8 T 4motion	125	AWM		03/01-05/05	PK20PR-P8	3245	0.8	-	IK20TT	IK20TT	4
1.9 TDI	74/96	AVB; AVF; AWW	Ch: >3B-2-350 000	11/00-05/05	DG-005		11V				4
1.9 TDI	74/96	AVB; AVF; AWW	Ch: 3B-2-350 001>	11/00-05/05	DG-109		11V				4
1.9 TDI 4motion	96	AVF	Ch: >3B-2-350 000	11/00-05/05	DG-005		11V				4
1.9 TDI 4motion	96	AVF	Ch: 3B-2-350 001>	11/00-05/05	DG-109		11V				4
2.0	85/96	ALT; AZM		11/00-05/05	K20PBR-S10	5061	1.0	K20TT	IK20TT	IK20TT	4
2.0 4motion	85	AZM		11/00-05/05	K20PBR-S10	5061	1.0	K20TT	IK20TT	IK20TT	4
2.3 V5	125	AZX		11/00-05/05	PKJ16CR-L11	3246	1.1	-	IK16TT	IK16TT	5
2.3 V5 4motion	125	AZX		11/00-05/05	PKJ16CR-L11	3246	1.1	-	IK16TT	IK16TT	5
2.3 VR5	125	AZX		11/00-05/05	PKJ16CR-L11	3246	1.1	-	IK16TT	IK16TT	5
2.3 VR5 4motion	125	AZX		11/00-05/05	PKJ16CR-L11	3246	1.1	-	IK16TT	IK16TT	5
2.5 TDI	110/ 120	AFB; AKN; BDG		11/00-05/05	DG-144		11V				6
2.5 TDI 4motion	110/ 132	AFB; AKN; BAU; BDH		11/00-05/05	DG-144		11V				6
2.8 4motion	142	AMX; ATQ; BBG		11/00-05/05	K20TXR	5063	1.0	K20TT	IK20TT	IK20TT	6
4.0 W8 4motion	202	BDN; BDP		09/01-09/04	K20TXR	5063	1.0	K20TT	IK20TT	IK20TT	8
PASSAT (3C) (05-11)											
1.4 TSI	90	CAXA		05/07-11/10	PKJ20CR8	3173	0.8	-	-	VK20G	4
1.6	75	BSE; BSF		05/05-05/07	K20PBR-S10	5061	1.0	K20TT	IK20TT	IK20TT	4
1.6 FSI	85	BLF		03/05-05/07	K20PBR-S10	5061	1.0	K20TT	IK20TT	IK20TT	4
1.6 TDI	77	CAYC		08/09-11/10	DG-193		4.4V				4
1.8 TSI	118	BZB; CDAA		05/07-10/11	K20PR-U	3145	0.8	K20TT	IK20TT	IK20TT	4
1.8 TSI	118	BZB; CDAA		05/07-07/10	PK22PR8	3273	0.8	-	-	VK22	4
1.9 TDI	77	BKC; BLS; BXE		03/05-11/08	DG-177		5V				4
2.0 BlueTDI	105	CBAC		01/09-11/10	DG-193		4.4V				4
2.0 FSI	110	BLY; BVZ		03/05-05/07	K20PR-U	3145	0.8	K20TT	IK20TT	IK20TT	4
2.0 FSI	147	AXX; BWA; CAWB; CCTA; CCZA		07/05-11/10	PK22PR8	3273	0.8	-	-	VK22	4
2.0 FSI	125	CCTB		08/07-11/10	VK22	5610	0.8	-	-	VK22	4
2.0 FSI	110	BLR; BVY		03/05-05/07	VKA16	5622	1.1	-	-	VKA16	4
2.0 FSI 4motion	110	BLX; BLY		09/05-11/05	K20PR-U	3145	0.8	K20TT	IK20TT	IK20TT	4
2.0 FSI 4motion	110	BVX		09/05-05/07	VKA16	5622	1.1	-	-	VKA16	4
2.0 TDI	90/ 100/ 120	BMA; BUZ; BVE		08/05-11/10	DG-190		4.4V				4
2.0 TDI	81/ 100/ 125	CBAA; CBBB; CBDC		03/05-11/10	DG-193		4.4V				4
2.0 TDI 16V	103	BKP		05/07-11/10	DG-190		4.4V				4
2.0 TDI 16V	103	CBAB		03/05-11/10	DG-193		4.4V				4

Spark & Glow Plugs







Application Tables







	KW								QTY
VW continued									
PASSAT (3C) (05-11) continued									
2.0 TDI 16V 4motion	103	BKP		05/07-11/10	DG-190		4.4V		4
2.0 TDI 16V 4motion	103	CBAB		03/05-11/10	DG-193		4.4V		4
2.0 TDI 4motion	125	CBBB		05/09-11/10	DG-193		4.4V		4
3.2 FSI 4motion	184	AXZ		11/05-11/10	VXUHC22G	5652	0.9	-	6
PASSAT (32, 33) (73-80)									
1.3	40/44	FY; FZ; ZA; ZF		05/73-07/80	W20EP-U	3043	0.8	W20TT	4
1.5 D	37	CK		02/77-07/80	DG-012		11V		4
1.6	53/ 55/ 63	FS;WP; YN; YP; YY		08/75-07/80	W20EPR-U	3047	0.8	W20TT	4
1.6 D	40	CR		02/79-07/80	DG-012		11V		4
1.6 GLi	81	YS		02/79-07/80	W20EPR-U	3047	0.8	W20TT	4
PASSAT (32B) (80-91)									
1.3	44	EP		01/85-07/86	W16EPB10	5064	1.0	W16TT	4
1.3	40/44	FY; FZ		08/80-07/83	W20EPR-U	3047	0.8	W20TT	4
1.3	44	EP; EU		08/80-07/86	W20EP-U	3043	0.8	W20TT	4
1.6	51/53	DTA; PP		02/86-03/88	W16EPB10	5064	1.0	W16TT	4
1.6	55	JU		08/84-03/88	W16EPR-U	3021	0.8	W16TT	4
1.6	51/ 55/ 63	WV; WY; YN; YP		01/81-03/88	W20EPR-U	3047	0.8	W20TT	4
1.6 D	40	CR; JK		08/80-03/88	DG-012		11V		4
1.6 TD	51/59	CY; RA		01/85-03/88	DG-012		11V		4
1.8	64/66	DS; JN; JV; RM		01/83-03/88	W20EPB	5065	0.85	W20TT	4
1.8	64	RM		05/86-03/88	W20EP-U	3043	0.8	W20TT	4
1.8 Syncro	66	JN		01/86-03/88	W20EPB	5065	0.85	W20TT	4
1.9	85	WN		01/81-07/83	W22EPR-U	3088	0.8	W22TT	5
1.9	85	WN		01/81-07/83	W22EP-U	3085	0.8	W22TT	5
2.0	85	JS		08/83-03/88	W20EPB	5065	0.85	W20TT	5
2.0 Syncro	85	JS		05/84-03/88	W20EPB	5065	0.85	W20TT	5
2.1	85	WE		01/81-07/83	W20EPR-U	3047	0.8	W20TT	5
2.2	85/ 100	KV; KX		01/85-03/88	W20EPB	5065	0.85	W20TT	5
2.2 Syncro	88	JT		08/85-03/88	W20EPB	5065	0.85	W20TT	5
PASSAT (362, 365) (10-)									
1.4 TSI	90	CAXA		08/10-	PKJ20CR8	3173	0.8	-	4
1.4 TSI MultiFuel	118	CKMA		11/10-	PK22PR8	3273	0.8	-	4
1.6 TDI	77	CAYC		08/10-	DG-193		4.4V		4
1.8 TSI	112/ 118	CDAA; CDAB		08/10-	PK22PR8	3273	0.8	-	4
2.0 TDI	100/ 103/ 125	CFFA; CFFB; CFGB; CLLA		08/10-	DG-193		4.4V		4
2.0 TDI 4motion	103/ 125	CFFB; CFGB		08/10-	DG-193		4.4V		4
2.0 TSI	155	CCZB		11/10-	PK22PR8	3273	0.8	-	4
2.0 TSI 4motion	155	CCZB		01/12-	PK22PR8	3273	0.8	-	4
PASSAT CC (357) (08-12)									
1.8 TSI	112/ 118	BZB - E5; CDAB; CGYA		06/08-11/10	PK22PR8	3273	0.8	-	4
2.0 BlueTDI	105	CBAC		05/09-11/10	DG-193		4.4V		4
2.0 TDI	100/ 103/ 120/ 125	CBAA; CBAB; CBBA; CBBB; CFFA; CFFB; CFGB; CLLA		06/08-01/12	DG-193		4.4V		4
2.0 TDI 4motion	103/ 125	CBAB; CBBB; CFFB; CFGB		08/09-01/12	DG-193		4.4V		4
2.0 TSI	147	CAWB		06/08-12/10	PK22PR8	3273	0.8	-	4
2.0 TSI	155	CCZB		11/10-01/12	VK22	5610	0.8	-	4
PHAETON (3D) (02-)									
3.0 V6 TDI 4motion	165/ 171/ 176	BMK; CARA; CARB; CEXA		09/04-	DG-193		4.4V		6
3.6 V6 4motion	206	CHNA; CMVA		11/08-	VXUHC22G	5652	0.9	-	6
4.2 V8 4motion	246	BGH; BGJ		05/03-	K20PBR-S10	5061	1.0	K20TT	8
5.0 V10 TDI 4motion	230	AJS		11/02-	DG-109		11V		10
6.0 W12 4motion	309/ 331	BAN; BRN; BTT		04/02-	PKJ20CR-L11	3247	1.1	-	12
POLO (6N1) (94-99)									
1.0	33	AEV		10/94-12/99	W20EPBR-S	5067	0.85	W20TT	4
1.4	44	AEX		05/98-12/99	W20EPBR-S	5067	0.85	W20TT	4
1.7 SDI	42/44	AHG; AKU		04/97-12/99	DG-005		11V		4
1.9 D	47	AEF		10/94-12/99	DG-012		11V		4

	KW					Standard					QTY
VW continued											
POLO (6N1) (94-99) continued											
1.9 SDI	47	AGD		07/96-12/99	DG-005		11V				4
45 1.0	33	AEV		10/94-09/96	W20EPBR-S	5067	0.85	W20TT	IW20TT	IW20TT	4
50 1.0	37	AER		09/96-10/99	W20EPBR-S	5067	0.85	W20TT	IW20TT	IW20TT	4
55 1.3	40	ADX		10/94-07/95	W20EPBR-S	5067	0.85	W20TT	IW20TT	IW20TT	4
55 1.4	40	AEX		08/95-10/99	K20PBR-S10	5061	1.0	K20TT	IK20TT	IK20TT	4
60 1.4	44	AKV		07/95-10/99	W20EPBR-S	5067	0.85	W20TT	IW20TT	IW20TT	4
60 1.7 SDI	44	AKU		08/97-10/99	DG-005		11V				4
64 1.9 D	47	AEF		10/94-10/99	DG-012		11V				4
64 1.9 SDI	47	AGD		07/96-10/99	DG-005		11V				4
75 1.6	55	AEE		10/94-10/99	W20EPBR-S	5067	0.85	W20TT	IW20TT	IW20TT	4
100 1.4 16V	74	AFH		04/96-10/99	K20PBR-S10	5061	1.0	K20TT	IK20TT	IK20TT	4
120 1.6 16V GTI	88	AJV		09/98-10/99	K20PBR-S10	5061	1.0	K20TT	IK20TT	IK20TT	4
POLO (6N2) (99-01)											
1.0	37	AUC		10/99-09/01	PKJ16CR-L11	3246	1.1	-	IK16TT	IK16TT	4
1.4	40	AKP		10/99-09/01	K20PBR-S10	5061	1.0	K20TT	IK20TT	IK20TT	4
1.4	44	AUD		10/99-09/01	PKJ16CR-L11	3246	1.1	-	IK16TT	IK16TT	4
1.4 16V	55/74	AHW; AQQ		10/99-09/01	K20PBR-S10	5061	1.0	K20TT	IK20TT	IK20TT	4
1.4 TDI	55	AMF		10/99-09/01	DG-005		11V				3
1.6 16V GTI	92	AVY		10/99-09/01	K20PBR-S10	5061	1.0	K20TT	IK20TT	IK20TT	4
1.7 SDI	44	AKU		10/99-09/01	DG-005		11V				4
1.9 D	47	AEF		10/99-09/01	DG-012		11V				4
1.9 SDI	47	AGD; ASX		10/99-09/01	DG-005		11V				4
POLO (6R, 6C) (09-)											
1.2	44/51	CGPA; CGPB		06/09-	KJ20DR-M11	3374	1.1	-	IK20TT	IK20TT	3
1.2 TDI	55	CFWA		10/09-	DG-193		4.4V				3
1.4	63	CDDA; CGGB; CLPA		06/09-	KJ20DR-M11	3374	1.1	-	IK20TT	IK20TT	4
1.4 BiFuel	60	CMAA		03/10-01/11	KJ20DR-M11	3374	1.1	-	IK20TT	IK20TT	4
1.4 GTI	132	CAVE; CTHE		05/10-	PKJ20CR8	3173	0.8	-	-	VK20G	4
1.6	63/77	CFNA; CFNB; CLSA		05/10-	KJ20DR-M11	3374	1.1	-	IK20TT	IK20TT	4
1.6 BiFuel	60	CNKA		01/11-	KJ20DR-M11	3374	1.1	-	IK20TT	IK20TT	4
1.6 TDI	55/ 66/ 77	CAYA; CAYB; CAYC; CLNA		06/09-	DG-193		4.4V				4
POLO (9N) (01-09)											
1.2	40/44	BBM; BMD		01/02-11/09	KJ16CR-L11	3132	1.1	K16TT	IK16TT	IK16TT	3
1.2	40	AWY		01/02-07/04	SKJ16CR-L11	3396	1.1	-	IK16TT	IK16TT	3
1.2 12V	47/51	AZQ; BME; BZG		10/01-11/09	KJ16CR-L11	3132	1.1	K16TT	IK16TT	IK16TT	3
1.4 16V	55/74	AUA;BBY; AUB; BBZ		10/01-05/08	K20PBR-S10	5061	1.0	K20TT	IK20TT	IK20TT	4
1.4 16V	55	BKY		10/01-05/08	KJ16CR-L11	3132	1.1	K16TT	IK16TT	IK16TT	4
1.4 16V	59	BUD		05/06-11/09	KJ20DR-M11	3374	1.1	-	IK20TT	IK20TT	4
1.4 FSI	63	AXU		02/02-07/06	K20PBR-S10	5061	1.0	K20TT	IK20TT	IK20TT	4
1.4 TDI	51/ 55/ 59	AMF; BAY; BNM; BNV		04/05-11/09	DG-109		11V				3
1.6 16V	77	BTS		05/06-11/09	KJ20DR-M11	3374	1.1	-	IK20TT	IK20TT	4
1.8 GTI	110	BJX		09/05-11/09	PK20PR-P8	3245	0.8	-	IK20TT	IK20TT	4
1.8 GTi Cup Edition	132	BBU		05/06-11/09	PK20PR-P8	3245	0.8	-	IK20TT	IK20TT	4
1.9 SDI	47	ASY		10/01-11/09	DG-005		11V				4
1.9 TDI	74/96	ASZ; ATD; AXR; BLT		10/01-11/09	DG-109		11V				4
POLO (86) (75-81)											
0.8	25	HE		09/75-07/78	W20EPR-U	3047	0.8	W20TT	IW20TT	IW20TT	4
0.9	29	HA		09/75-09/81	W20EP-U	3043	0.8	W20TT	IW20TT	IW20TT	4
1.1	37	HB		03/75-09/81	W20EP-U	3043	0.8	W20TT	IW20TT	IW20TT	4
1.3	44	HH		12/76-09/81	W20EP-U	3043	0.8	W20TT	IW20TT	IW20TT	4
POLO (86C, 80) (81-94)											
1.0	33	AAU		08/92-07/94	W20EPBR-S	5067	0.85	W20TT	IW20TT	IW20TT	4
1.0	29/33	AAU; GL; HZ		01/85-01/92	W20EP-U	3043	0.8	W20TT	IW20TT	IW20TT	4
1.0 CAT	33	ACM		08/89-09/94	W20EPB	5065	0.85	W20TT	IW20TT	IW20TT	4
1.0 CAT	33	ACM		08/89-09/94	W20EP-U	3043	0.8	W20TT	IW20TT	IW20TT	4
1.1	37	HB		10/81-09/89	W20EP-U	3043	0.8	W20TT	IW20TT	IW20TT	4
1.3	57	3F		03/91-09/94	W20EPB	5065	0.85	W20TT	IW20TT	IW20TT	4
1.3	37/ 40/ 43/ 44	HH; HJ; HK; HW		10/81-07/85	W20EP-U	3043	0.8	W20TT	IW20TT	IW20TT	4
1.3	55	GK		09/82-07/86	W22EPR-U	3088	0.8	W22TT	-	VW22	4
1.3	55	GK		09/82-09/89	W22EP-U	3085	0.8	W22TT	-	VW22	4
1.3 CAT	40/55	2G; 3F; AAV; MH; NZ		07/87-09/94	W20EPB	5065	0.85	W20TT	IW20TT	IW20TT	4
1.3 CAT	40	NZ		07/87-09/94	W20EP-U	3043	0.8	W20TT	IW20TT	IW20TT	4

Spark & Glow Plugs



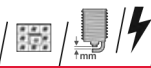





Application Tables







	KW				Standard 			Twin Tip 			QTY
VW continued											
POLO (86C, 80) (81-94) continued											
1.3 D	33	MN		08/86-07/90	DG-012		11V				4
1.3 G40	83	PY		08/90-09/94	W20EPB	5065	0.85	W20TT	IW20TT	IW20TT	4
1.3 G40	85	PY		01/87-08/90	W22EPB	5066	0.85	W22TT	-	VW22	4
1.4 D	35	1W		08/90-09/94	DG-012		11V				4
POLO Classic (6KV) (95-02)											
1.9 SDI	48	AEY		06/96-09/01	DG-005		11V				4
54 1.4	40	ANX		01/98-08/99	W20EPBR-S	5067	0.85	W20TT	IW20TT	IW20TT	4
57 1.7 SDI	42	AKW		07/97-09/01	DG-005		11V				4
60 1.4	44	AKV		12/95-09/01	W20EPBR-S	5067	0.85	W20TT	IW20TT	IW20TT	4
64 1.9 D	47	1Y		01/96-10/96	DG-012		11V				4
64 1.9 SDI	47	AEY		12/95-08/99	DG-005		11V				4
68 1.9 SDI	50	AGP; AQM		08/99-01/02	DG-005		11V				4
75 1.4 16V	55	AUA		10/99-09/01	K20PBR-S10	5061	1.0	K20TT	IK20TT	IK20TT	4
75 1.6	55	1F; AEE		11/95-09/01	W20EPBR-S	5067	0.85	W20TT	IW20TT	IW20TT	4
90 1.8	66	ADD		08/98-09/01	W20EPBR-S	5067	0.85	W20TT	IW20TT	IW20TT	4
90 1.9 TDI	66	AGR; AHU; ALE; ALH		09/96-09/01	DG-005		11V				4
100 1.6	74	AEH		12/95-09/01	K20PBR-S10	5061	1.0	K20TT	IK20TT	IK20TT	4
110 1.9 TDI	81	AFN; ASV		06/98-01/02	DG-005		11V				4
POLO Saloon (9A4) (02-)											
1.4	55/74	BBY; BBZ		07/03-	K20PBR-S10	5061	1.0	K20TT	IK20TT	IK20TT	4
1.4	55	BBY	OEM Optional	07/03-06/05	PKJ16CR-L11	3246	1.1	-	IK16TT	IK16TT	4
1.4 TDI	55	BAY		07/03-	DG-109		11V				3
1.9 SDI	47	ASY		09/02-	DG-005		11V				4
1.9 TDi	74	ATD		09/02-	DG-109		11V				4
POLO Variant (6KV) (97-01)											
1.4	40	AKP		12/98-09/01	K20PBR-S10	5061	1.0	K20TT	IK20TT	IK20TT	4
1.4	44	ANW		05/97-09/01	W20EPBR-S	5067	0.85	W20TT	IW20TT	IW20TT	4
1.4 16V	55	AUA		10/99-09/01	K20PBR-S10	5061	1.0	K20TT	IK20TT	IK20TT	4
1.6	74	AKL		05/97-09/01	K20PBR-S10	5061	1.0	K20TT	IK20TT	IK20TT	4
1.6	55	AEE		05/97-09/01	W20EPBR-S	5067	0.85	W20TT	IW20TT	IW20TT	4
1.7 SDI	42	AKW		08/97-09/01	DG-005		11V				4
1.9 SDI	47/50	AEY; AGP; AQM		06/97-09/01	DG-005		11V				4
1.9 TDI	66/81	AFN; AGR; AHU; ALE; ALH; ASV		05/97-09/01	DG-005		11V				4
SANTANA (81-85)											
1.3	44	EP		08/81-07/83	W16EPB10	5064	1.0	W16TT	IW16TT	IW16TT	4
1.6	55	DT; JU		08/83-12/84	W16EPB10	5064	1.0	W16TT	IW16TT	IW16TT	4
1.6	55/63	WV; WY; YP		08/81-07/83	W20EPR-U	3047	0.8	W20TT	IW20TT	IW20TT	4
1.6 D	40	CR; JK		08/81-12/84	DG-012		11V				4
1.6 TD	51	CY		12/81-12/84	DG-012		11V				4
1.8	66	DS		01/83-12/84	W20EPB	5065	0.85	W20TT	IW20TT	IW20TT	4
1.9	85	WN		08/81-07/83	W22EP-U	3085	0.8	W22TT	-	VW22	5
2.0	85	HP; JS		08/83-12/84	W20EPR-U	3047	0.8	W20TT	IW20TT	IW20TT	5
2.1	85	WE		08/82-12/83	W20EPR-U	3047	0.8	W20TT	IW20TT	IW20TT	5
SCIROCCO (53) (74-80)											
1.1	37	FA		04/74-07/79	W20EP-U	3043	0.8	W20TT	IW20TT	IW20TT	4
1.3	44	GF		08/79-07/80	W20EP-U	3043	0.8	W20TT	IW20TT	IW20TT	4
1.5	51	JB		08/77-07/80	W16EP-U	3018	0.8	W16TT	IW16TT	IW16TT	4
1.6	51/55	EM; FN; FV		08/75-07/79	W20EPR-U	3047	0.8	W20TT	IW20TT	IW20TT	4
1.6	63	FR		08/75-07/80	W20EP-U	3043	0.8	W20TT	IW20TT	IW20TT	4
1.6	81	EG		06/76-07/80	W22EPR-U	3088	0.8	W22TT	-	VW22	4
SCIROCCO (53B) (80-92)											
1.3	44	GF		08/80-12/83	W20EP-U	3043	0.8	W20TT	IW20TT	IW20TT	4
1.5	51	JB		08/80-12/83	W16EP-U	3018	0.8	W16TT	IW16TT	IW16TT	4
1.6	55	EW		01/83-12/89	W16EP-U	3018	0.8	W16TT	IW16TT	IW16TT	4
1.6	53	RE		04/86-07/90	W20EPBR-S	5067	0.85	W20TT	IW20TT	IW20TT	4
1.6	63	FR		08/80-04/84	W20EP-U	3043	0.8	W20TT	IW20TT	IW20TT	4
1.6	81	EG		08/80-07/82	W22EPR-U	3088	0.8	W22TT	-	VW22	4
1.8	66/70/82	EX; JH; PB		08/82-07/92	W20EPB	5065	0.85	W20TT	IW20TT	IW20TT	4
1.8	82	JJ		08/82-07/83	W22EPR-U	3088	0.8	W22TT	-	VW22	4
1.8 16V	95/102	KR; PL		10/85-07/92	K22PBR-S	5062	0.85	-	-	VK22	4
SCIROCCO (137) (08-)											
1.4 TSI	90/118	CAVD; CAXA; CMSB		05/08-	PKJ20CR8	3173	0.8	-	-	VK20G	4
2.0 R	195	CDLA		11/09-	PK22PR8	3273	0.8	-	-	VK22	4
2.0 R	188	CDLC		11/09-	VK22	5610	0.8	-	-	VK22	4

	KW								QTY		
VW continued											
SCIROCCO (137) (08-) continued											
2.0 TDI	100/103/125	CBBB; CBDB; CFGB; CFHB; CFHC		05/09-	DG-193		4.4V			4	
2.0 TSI	147/155	CAWB; CCZB		05/08-05/11	PK22PR8	3273	0.8	-	-	VK22	4
SHARAN (7M) (95-10)											
1.8 T 20V	110	AWC		09/97-03/10	PK20PR-P8	3245	0.8	-	IK20TT	IK20TT	4
1.9 TDI	81	AFN; AVG		09/96-04/00	DG-005		11V				4
1.9 TDI	96/110	ASZ; BTB		11/02-03/10	DG-109		11V				4
1.9 TDI	66/85	1Z; AHU; ANU; AUJ; BVK	Ch: >7M-2-030 004	09/95-03/10	DG-005		11V				4
1.9 TDI	66/85	1Z; AHU; ANU; AUJ; BVK	Ch: 7M-2-030 005>	09/95-03/10	DG-109		11V				4
1.9 TDI 4motion	85	AUY; BVK	Ch: >7M-2-030 004	04/00-03/10	DG-005		11V				4
1.9 TDI 4motion	85	AUY; BVK	Ch: 7M-2-030 005>	04/00-03/10	DG-109		11V				4
2.0	85	ADY		09/95-03/10	W20EPBR-S	5067	0.85	W20TT	IW20TT	IW20TT	4
2.0 LPG	85	ATM	LPG / GPL	05/08-03/10	K20PBR-S10	5061	1.0	K20TT	IK20TT	IK20TT	4
2.8 V6 24V	150	AYL		04/00-03/10	PKJ16CR-L11	3246	1.1	-	IK16TT	IK16TT	6
2.8 V6 24V 4motion	150	AYL		04/00-03/10	PKJ16CR-L11	3246	1.1	-	IK16TT	IK16TT	6
2.8 VR6	128	AAA; AMY		09/95-04/00	K20TXR	5063	1.0	K20TT	IK20TT	IK20TT	6
2.8 VR6 Syncro	128	AAA; AMY		11/96-04/00	K20TXR	5063	1.0	K20TT	IK20TT	IK20TT	6
SHARAN (7N) (10-)											
2.0 TDI	85/100/103/125/130	CFFA; CFFB; CFFE; CFGB; CFGC		05/10-	DG-193		4.4V				4
2.0 TDI 4motion	100/103	CFFA; CFFB		05/11-	DG-193		4.4V				4
2.0 TSI	147	CCZA		12/10-	PK22PR8	3273	0.8	-	-	VK22	4
TARO (89-97)											
1.8	61	2Y		04/89-09/94	W16EXR-U	3031	0.8	W16TT	IW16TT	IW16TT	4
2.2	69	4Y		06/89-07/94	W16EXR-U	3031	0.8	W16TT	IW16TT	IW16TT	4
2.2 4x4	69	4Y		06/89-07/94	W16EXR-U	3031	0.8	W16TT	IW16TT	IW16TT	4
2.4 D	58/59/61	2L		06/89-03/97	DG-211		11V				4
2.4 D 4x4	58/61	2L		04/89-03/97	DG-211		11V				4
2.4 i 4x4	84	22R		06/89-03/97	W16EXR-U	3031	0.8	W16TT	IW16TT	IW16TT	4
TIGUAN (5N) (07-)											
1.4 TSI	90	CAXA		08/10-	PKJ20CR8	3173	0.8	-	-	VK20G	4
2.0 TDI	81/103	CBAB; CFFB; CFFD		03/08-	DG-193		4.4V				4
2.0 TDI 4motion	100/103/120/125	CBAA; CBAB; CBBA; CBBB; CFFA; CFFB; CFGB; CLJA		09/07-	DG-193		4.4V				4
2.0 TFSI 4motion	125/147	CAWA; CAWB; CCTA; CCZA; CCZC		09/07-	PK22PR8	3273	0.8	-	-	VK22	4
2.0 TSI 4motion	132/155	CCZB; CCZD		05/11-	VK22	5610	0.8	-	-	VK22	4
TOUAREG (7L) (02-10)											
2.5 R5 TDI	120/128	BAC; BLK		01/03-05/10	DG-109		11V				5
3.0 TDI	155	BUN; CASB		04/06-05/10	DG-193		4.4V				6
3.0 V6 TDI	165/176	BKS; CASA; CASC; CATA		11/04-05/10	DG-193		4.4V				6
3.6 V6 FSI	206	BHK; BHL		10/05-05/10	VXUHC22G	5652	0.9	-	-	VXUHC22G	6
4.2 V8	228	AXQ		12/02-11/06	K20PBR-S10	5061	1.0	K20TT	IK20TT	IK20TT	8
4.2 V8 FSI	257	BAR		06/06-05/10	VKB20	5625	1.1	-	-	VKB20	8
5.0 V10 TDI	230	AYH		10/02-05/10	DG-109		11V				10
6.0 W12	331	BJN; CFRA		08/04-05/10	PKJ20CR-L11	3247	1.1	-	IK20TT	IK20TT	12
TOUAREG (7P) (10-)											
3.0 V6 TDI	150/165/176/180	CASA; CASD; CATA; CJGD; CJMA; CRCA; CVWA		01/10-	DG-193		4.4V				6
3.0 V6 TSI Hybrid	245	CGEA		04/10-	IK24	5311	0.8	-	-	-	6
3.6 V6 FSI	183/206	CGRA; CMTA		04/10-	VXUHC22G	5652	0.9	-	-	VXUHC22G	6
4.2 V8 FSI	265	CGNA		01/11-	VKB20	5625	1.1	-	-	VKB20	8
4.2 V8 TDI	250	CKDA		01/10-	DG-193		4.4V				8

Spark & Glow Plugs







Application Tables

	KW									QTY	
VW continued											
TOURAN (1T1, 1T2) (03-10)											
1.4 FSI	125	BLG; CAVB		11/06-05/10	PKJ20CR8	3173	0.8	-	-	VK20G	4
1.4 TSI	103	BMV; CAVC		02/06-05/10	PKJ20CR8	3173	0.8	-	-	VK20G	4
1.6	75	BGU; BSE; BSF		07/03-05/10	K20PBR-S10	5061	1.0	K20TT	IK20TT	IK20TT	4
1.6 FSI	85	BAG; BLF; BLP		02/03-01/07	K20PBR-S10	5061	1.0	K20TT	IK20TT	IK20TT	4
1.9 TDI	66/ 74/ 77	AVQ; BKC; BLS; BRU; BXE; BXF; BXJ		08/03-05/10	DG-177		5V				4
2.0 EcoFuel	80	BSX	Flexible fuel	02/06-05/09	VK20T	5501	0.8	-	IK20TT	IK20TT	4
2.0 FSI	110	BLR; BLY; BVZ		10/03-11/05	K20PR-U	3145	0.8	K20TT	IK20TT	IK20TT	4
2.0 FSI	110	AXW; BLX; BVY		10/03-11/05	VKA16	5622	1.1	-	-	VKA16	4
2.0 TDI	103	BMM		12/05-05/10	DG-177		5V				4
2.0 TDI	100	AZV		02/03-05/10	DG-190		4.4V				4
2.0 TDI	125	CFJA		12/05-05/10	DG-193		4.4V				4
2.0 TDI 16V	103	BKD		08/03-05/10	DG-190		4.4V				4
TOURAN (1T3) (10-)											
1.4 TSI	103/ 125	CAVB; CAVC; CTHB; CTHC		05/10-	PKJ20CR8	3173	0.8	-	-	VK20G	4
1.6 TDI	66/77	CAYB; CAYC		05/10-	DG-193		4.4V				4
2.0 TDI	81/ 96/ 103/ 125	CFHC; CFHF; CFJA; CLCA		05/10-	DG-193		4.4V				4
TRANSPORTER II (67-79)											
1.6	34/37	AF; AS		08/67-07/79	W20FSR-U	6053	0.7	WF20TT	-	-	4
1.7	49	CA; CB		08/71-12/73	W16ESR-U	3110	0.8	-	-	-	4
2.0	51	CJ; GD; GE		08/75-07/79	W16ESR-U	3110	0.8	-	-	-	4
TRANSPORTER III (79-92)											
1.6	37	CT	Eng: 065011>	05/79-12/82	W20ES-U	3051	0.8	-	-	-	4
1.6 D	37	CS		01/81-07/87	DG-012		11V				4
1.6 TD	51	JX		08/84-07/92	DG-012		11V				4
1.6 TD Syncro	51	JX		03/86-07/92	DG-012		11V				4
1.7 D	42	KY		10/86-07/92	DG-012		11V				4
1.9	44/57	DF; DG		08/82-07/92	W20EPB	5065	0.85	W20TT	IW20TT	IW20TT	4
1.9 Syncro	57	DG		12/84-07/92	W20EPB	5065	0.85	W20TT	IW20TT	IW20TT	4
2.0	51	CU; CV		05/79-04/86	W16ESR-U	3110	0.8	-	-	-	4
2.1	82	DJ		08/84-07/92	W20EPBR-S	5067	0.85	W20TT	IW20TT	IW20TT	4
2.1	64/70	MV; SR		08/85-07/92	W20ESR-U	3057	0.8	-	-	-	4
2.1	82	DJ		03/86-07/92	W22EPB	5066	0.85	W22TT	-	VW22	4
2.1 CAT	70	MV		06/89-07/92	W20ESR-U	3057	0.8	-	-	-	4
2.1 i	68	SS		07/89-07/92	W20ESR-U	3057	0.8	-	-	-	4
2.1 Syncro	82	DJ		03/86-07/92	W20EPB	5065	0.85	W20TT	IW20TT	IW20TT	4
2.1 Syncro	64/70	MV; SR		08/85-07/92	W20ESR-U	3057	0.8	-	-	-	4
2.1 Syncro	82	DJ		03/86-07/92	W22EP-U	3085	0.8	W22TT	-	VW22	4
TRANSPORTER IV (70X, 7D) (90-03)											
1.8	49	PD		12/90-07/92	W20EPB	5065	0.85	W20TT	IW20TT	IW20TT	4
1.9 D	44/45	1X		09/90-12/95	DG-012		11V				4
1.9 TD	50	ABL		10/92-04/03	DG-012		11V				4
2.0	62	AAC		07/90-04/03	W16ETR-S	3285	1.0	W16TT	IW16TT	IW16TT	4
2.0	62	AAC		07/90-04/03	W20EPBR-S	5067	0.85	W20TT	IW20TT	IW20TT	4
2.4 D	55/57	AAB; AJA		09/90-04/03	DG-012		11V				5
2.4 D Syncro	57	AAB		10/92-09/98	DG-012		11V				5
2.5	85	APL; AVT		08/96-04/03	K16TNR-S9	3329	0.9	K16TT	IK16TT	IK16TT	5
2.5	81/85	AEN; AET		11/90-04/03	W20EPBR-S	5067	0.85	W20TT	IW20TT	IW20TT	5
2.5 Syncro	85	APL; AVT		08/96-04/03	K16TNR-S9	3329	0.9	K16TT	IK16TT	IK16TT	5
2.5 Syncro	81	AAF; ACU		10/92-04/03	W20EPB	5065	0.85	W20TT	IW20TT	IW20TT	5
2.5 Syncro	85	AET		07/96-04/03	W20EPBR-S	5067	0.85	W20TT	IW20TT	IW20TT	5
2.5 TDI	65/ 75/ 111	ACV; AHY; AJT; AUF; AXG; AYC; AYY		09/95-04/03	DG-005		11V				5
2.5 TDI Syncro	75	ACV; AXL		09/95-04/03	DG-005		11V				5
2.8	103	AES		05/96-05/00	K20TXR	5063	1.0	K20TT	IK20TT	IK20TT	6
2.8 VR 6	103	AES		11/95-04/00	K20TXR	5063	1.0	K20TT	IK20TT	IK20TT	6
2.8 VR6	103	AES		05/96-05/00	K20TXR	5063	1.0	K20TT	IK20TT	IK20TT	6
2.8 VR6	150	AMV		04/00-04/03	PKJ16CR-L11	3246	1.1	-	IK16TT	IK16TT	6
2.8 VR6 Syncro	103	AES		01/96-04/96	K20TXR	5063	1.0	K20TT	IK20TT	IK20TT	6
TRANSPORTER V (7H, 7E, 7J) (03-)											
1.9 TDI	63/77	AXB; AXC		04/03-11/09	DG-109		11V				4
1.9 TDI	62/75	BRR; BRS		01/06-11/09	DG-177		5V				4
2.0	85	AXA		11/03-	K20PBR-S10	5061	1.0	K20TT	IK20TT	IK20TT	4

	KW					Standard		Twin Tip		QTY	
VW continued											
TRANSPORTER V (7H, 7E, 7J) (03-) continued											
2.0 BiTDI	132	CFCA		09/09-	DG-193		4.4V			4	
2.0 BiTDI 4motion	132	CFCA		09/09-	DG-193		4.4V			4	
2.0 TDI	62/ 75/ 84/ 100/ 103	CAAA; CAAB; CAAC; CAAD; CAAE; CCHA; CCHB		05/10-	DG-193		4.4V			4	
2.0 TDI 4motion	100/ 103	CAAC; CAAE; CCHA; CCHB		09/09-	DG-193		4.4V			4	
2.0 TSI	110/ 150	CJKA; CJKB		05/11-	PK22PR8	3273	0.8	-	-	VK22	4
2.0 TSI 4motion	150	CJKA		07/11-	PK22PR8	3273	0.8	-	-	VK22	4
2.5 TDi	96/ 120/ 128	AXD; AXE; BLJ		04/03-11/09	DG-109		11V			5	
2.5 TDI 4motion	96/ 128	AXD; AXE		04/04-11/09	DG-109		11V			5	
3.2 V6	173	BKK		08/03-05/06	PK22PR8	3273	0.8	-	-	VK22	6
VENTO (1H2) (91-98)											
1.4	44	ABD		11/91-07/95	W16EPB10	5064	1.0	W16TT	IW16TT	IW16TT	4
1.4	44	AEX		07/95-09/98	W20EPBR-S	5067	0.85	W20TT	IW20TT	IW20TT	4
1.6	74	AEK; AFT		12/95-09/98	K16TNR-S9	3329	0.9	K16TT	IK16TT	IK16TT	4
1.6	74	AEK; AFT		10/94-09/98	K20PBR-S10	5061	1.0	K20TT	IK20TT	IK20TT	4
1.6	55	ABU		09/92-09/94	W16EPB10	5064	1.0	W16TT	IW16TT	IW16TT	4
1.6	55	AEA; AEE		10/94-09/98	W20EPBR-S	5067	0.85	W20TT	IW20TT	IW20TT	4
1.8	55/66	AAM; ABS; ADZ		11/91-09/98	W20EPBR-S	5067	0.85	W20TT	IW20TT	IW20TT	4
1.9 D	48	1Y		11/91-09/98	DG-012		11V			4	
1.9 SDI	47	AEY		04/97-09/98	DG-005		11V			4	
1.9 TD	55	AAZ		11/91-09/98	DG-012		11V			4	
1.9 TDI	66/81	1Z; AFN; AHU; ALE		09/93-09/98	DG-005		11V			4	
2.0	85	2E; ADY; AGG; AKR		11/91-09/98	W20EPBR-S	5067	0.85	W20TT	IW20TT	IW20TT	4
2.8 VR6	120/ 128	AAA		01/92-09/98	K20TXR	5063	1.0	K20TT	IK20TT	IK20TT	6
WARTBURG											
353 (66-91)											
1.0	37	353,18		04/69-02/75	M22	5003	0.7	-	-	-	3
1.0	33/37	353,18		06/66-02/75	W20FPR-U	3070	0.7	WF20TT	-	-	3
1.0 (353 W 000)	37	353,18		02/75-08/88	W20FPR-U	3070	0.7	WF20TT	-	-	3
1.3	43	4VO7;2/7;5GRF		09/88-05/91	W20EP-U	3043	0.8	W20TT	IW20TT	IW20TT	4
WESTFIELD											
130 (97-)											
1.6	77	LJF		01/97-	Q20PR-U11	3008	1.1	Q20TT	IQ20TT	IQ20TT	4
1.8	85	RQB		01/97-	PT16VR10	5093	1.0	TV16TT	ITV16TT	ITV16TT	4
ZE (93-97)											
1.8 i	96	RQB		01/93-12/97	PT16VR10	5093	1.0	TV16TT	ITV16TT	ITV16TT	4
WIESMANN											
GT MF4 (03-)											
4.8	270	N62 B48 B		09/03-	VK20	5604	1.1	-	IK20TT	IK20TT	8
MF3 Roadster (96-)											
2.8	142	M52286S1		01/96-	K20TXR	5063	1.0	K20TT	IK20TT	IK20TT	6
3.2	236	S50326S1		01/96-	VXU22	5608	0.9	-	-	VXU22	6
3.2	252	S54326S4		07/03-	VXU24	5609	0.9	-	-	VXU24	6
MF4 Roadster (09-)											
4.8	270	N62 B48 B		03/09-	VK20	5604	1.1	-	IK20TT	IK20TT	8
WOLSELEY											
HORNET (61-70)											
1.0	28	99LFD		01/61-12/70	W20EXR-U	3066	0.8	W20TT	IW20TT	IW20TT	4
ZASTAVA											
10 (05-)											
1.2 60	44	188A4.000		10/05-	K16PR-U	3191	0.8	K16TT	IK16TT	IK16TT	4
101 (73-93)											
1.1	37/ 40/ 41	128 A.000; 128 A.064		05/75-12/93	W20EP-U	3043	0.8	W20TT	IW20TT	IW20TT	4
1.1 Super	47	128 AC 5000		07/79-09/81	W20EP-U	3043	0.8	W20TT	IW20TT	IW20TT	4
1.3	48	128 AR 000		10/81-12/93	W20EP-U	3043	0.8	W20TT	IW20TT	IW20TT	4
YUGO (80-95)											
0.9	33	9A		04/80-06/92	W16EPR-U	3021	0.8	W16TT	IW16TT	IW16TT	4
60 EFI (145 A)	44	100 GL. 0.64		08/91-06/95	W16EPR-U	3021	0.8	W16TT	IW16TT	IW16TT	4
65 EFI (145 A)	48	13 E 1.064		08/91-06/95	W20EPR-U	3047	0.8	W20TT	IW20TT	IW20TT	4

Spark & Glow Plugs

Application Tables

	KW					Standard			Twin Tip			QTY
ZASTAVA <i>continued</i>												
YUGO Florida (88-)												
1.3 (103 A)	50	13 E.3.064		03/91-	W20EPR-U	3047	0.8	W20TT	IW20TT	IW20TT		4
ZAZ												
CHANCE (04-)												
1.3	52	MEMZ-310		10/04-	W20EPR-U	3047	0.8	W20TT	IW20TT	IW20TT		4
LANOS (04-)												
1.4	55			10/04-	W20EPR-U	3047	0.8	W20TT	IW20TT	IW20TT		4
1.5	63	A15SM		10/04-	W20EPR-U	3047	0.8	W20TT	IW20TT	IW20TT		4
1.6 16V	78	A16DMS		10/04-	K20PR-U11	3121	1.1	K20TT	IK20TT	IK20TT		4
SENS (04-)												
1.3	52	MEMZ-310		10/04-	W20EPR-U	3047	0.8	W20TT	IW20TT	IW20TT		4
SLAVUTA (95-)												
1.1	38	MEMZ-245		03/95-10/01	W20EPR-U	3047	0.8	W20TT	IW20TT	IW20TT		4
1.2	43			10/01-	W20EPR-U	3047	0.8	W20TT	IW20TT	IW20TT		4
1.3	44	MEMZ-310		10/01-	W20EPR-U	3047	0.8	W20TT	IW20TT	IW20TT		4
TAVRIJA (89-)												
1.1	37	MEMZ-245		01/89-	W20EPR-U	3047	0.8	W20TT	IW20TT	IW20TT		4
1.2	42			01/98-	W20EPR-U	3047	0.8	W20TT	IW20TT	IW20TT		4
1.3	44/52	MEMZ-310		01/89-	W20EPR-U	3047	0.8	W20TT	IW20TT	IW20TT		4

DENSO Buyers Guide



DENSO P/N	TT	MAKE	MODEL
DG-001	-	ALFA ROMEO	145 155 (92-97) 164 (87-98) AR 6 (79-89) AR 8 (78-89)
		ARO	10 (80-06) 240-244 (78-06)
		BEDFORD	BLITZ (69-87) MIDI (84-92)
		BERTONE	FREECLIMBER (89)
		BMW	3 (E30) (82-94) 3 (E36) (90-00) 5 (E28) (81-87) 5 (E34) (87-97) 5 (E39) (95-04) 7 (E38) (94-01)
		CARBODIES	FX FAIRWAY (87- FX4 (59-89) FX4S (86-89)
		CHEVROLET	C1500 (91-00) C3500 (93-96)
		CHRYSLER	VOYAGER (90-95) VOYAGER (95-01)
		CITROËN	BERLINGO (MF) (BX (82-94) C15 (84-05) C25 (81-94) C35 (73-94) CX I (74-85) CX II (85-92) EVASION (94-02) JUMPER (94-02) JUMPY (95-) VISA (78-91) XANTIA (93-98) XANTIA (98-03) XM (89-94) XM (94-00) XSARA (97-05) ZX (91-98)
		DAF	400-Serie (89-9)
		DAIHATSU	HIJET (92-)
		DALLAS	FUN (94-)
		DODGE	CARAVAN (95-02)
		FIAT	127 (71-86) 131 (74-84) 132 (72-82) 147 (76-96) 242-SERIE (75-8 ARGENTA (78-86) BRAVA (95-02) BRAVO I (95-01) CAMPAGNOLA (74- CROMA (85-96) DUCATO (82-90) DUCATO (89-94) DUCATO (94-02) DUNA (87-91) ELBA (86-96) FIORINO (80-93) FIORINO (88-01) PALIO (96-) PANDA (80-04) PUNTO (93-00) REGATA (83-90) RITMO (78-88) SCUDO (96-06) STRADA (99-) TALENTO (89-94) TEMPRA (90-96) TIPO (87-95)

DENSO P/N	TT	MAKE	MODEL
DG-001	-		ULYSSE (94-02)
<i>continued</i>			UNO (83-00)
		FORD	GRANADA (72-85) SCORPIO I (85-9 SIERRA (82-87) SIERRA (87-93)
		FSO	POLONEZ II (88- POLONEZ III (92
		HYUNDAI	LANTRA II (95-0
		INNOCENTI	ELBA (91-96)
		ISUZU	CAMPO (77-91) D-MAX (02-)
		IVECO	DAILY II (89-99
		JEEP	CHEROKEE (84-01
		LADA	NIVA (2121) (76
		LANCIA	DEDRA (89-99) DELTA I (79-94) PRISMA (83-92) THEMA (84-94) ZETA (95-02)
		LAND ROVER	88 90 DEFENDER (90-) RANGE ROVER II
		LDV	400 (86-98) CONVOY (96-09) PILOT (96-05)
		MAHINDRA	CJ 3 (88-92) CJ5 (87-)
		MERCEDES-BENZ	100 (631) (88-9 190 (W201) (82- COUPE (C123) (7 G-CLASS (W460) KOMBI (S123) (7 KOMBI (S124) (8 Saloon (W123) (Saloon (W124) (SPRINTER 2-t (9 SPRINTER 3-t (9 SPRINTER 4-t (9 T1 (601) (77-96 T1 (602) (77-96 T1
		MERCEDES-BENZ CV	UNIMOG
		OPEL	ASCONA B (75-81 ASCONA C (81-88 ASTRA F (91-01) ASTRA F CLASSIC ASTRA G (98-09) FRONTERA A (92- KADETT D (79-84 KADETT E (84-94 OMEGA A (86-94) OMEGA B (94-03) REKORD E (77-86 SENATOR A (78-8 VECTRA A (88-95
		PEUGEOT	205 I (83-94) 205 II (87-98) 305 I (77-82) 305 II (82-90) 306 (93-02) 309 I (85-89) 309 II (89-93) 405 I (87-93) 405 II (92-99) 406 (95-04) 504 (68-89) 505 (79-95) 604 (77-87) 605 (89-99)

DENSO P/N	TT	MAKE	MODEL
DG-001	-		806 (94-02)
<i>continued</i>			BOXER (94-02)
			EXPERT (96-)
			J5 (81-90)
			J5 (90-94)
			J7 (68-80)
			J9 (80-87)
			PARTNER
		PIAGGIO	PORTER (93-)
		PUCH	G-MODELL (W460)
		RENAULT	9 (81-89)
			11 (83-88)
			18 (78-93)
			19 I (88-92)
			19 II (92-01)
			20 (75-83)
			21 (86-95)
			25 (84-93)
			30 (75-86)
			CLIO I (90-98)
			ESPACE I (84-92)
			ESPACE II (91-9)
			EXPRESS (95-99)
			FUEGO (80-85)
			MASTER I (80-98)
			RAPID (85-98)
			SAFRANE I (92-9)
			SUPER 5 (84-96)
			TRAFIC (80-89)
			TRAFIC (89-01)
		RENAULT TRUCKS	MASCOTT (99-10)
		ROVER	200 (XW) (89-99)
			400 (90-98)
			800 (86-99)
			MAESTRO (90-95)
			MONTEGO (84-95)
		SEAT	132 (73-82)
			IBIZA I (84-93)
			MALAGA (84-93)
			RITMO (78-83)
			RONDA (82-88)
		SUZUKI	BALENO (95-02)
			SAMURAI (88-04)
			VITARA (88-99)
		TALBOT	180 (73-82)
			EXPRESS 1000 -1
			EXPRESS 1000 -1
			HORIZON (78-86)
			SIMCA (1609, 16)
			TAGORA (80-87)
		TATA	LOADBETA (94-06)
		TOYOTA	LAND CRUISER (J)
		UAZ	31512 (98-)
		VAUXHALL	ASTRA I (79-86)
			ASTRA II (84-94)
			ASTRA III (F) (
			ASTRA IV (G) (9
			CARLTON II (77-
			CARLTON III (86
			CAVALIER II (81
			CAVALIER III (8
			FRONTERA I (A)
			OMEGA (B) (94-0
			ROYALE (78-87)
DG-003	-	CITROËN	AX (86-98)
			BERLINGO (MF) (
			JUMPY (95-)
			SAXO (96-04)
			XSARA (97-05)
		FIAT	DUCATO (94-02)
			SCUDO (96-06)

DENSO P/N	TT	MAKE	MODEL
DG-003	-	NISSAN	MICRA II (92-03)
<i>continued</i>		PEUGEOT	106 I (91-96)
			106 II (96-)
			206 (98-)
			306 (93-02)
			EXPERT (96-)
			PARTNER
		ROVER	100
		TOYOTA	COROLLA (E11) (
DG-004	-	CITROËN	AX (86-98)
		FIAT	DUCATO (94-02)
		FORD	ESCORT IV (85-9
			ESCORT V (90-94
			ESCORT VI (92-9
			ESCORT VII (95-
			FIESTA II (83-9
			FIESTA III (89-
			MONDEO I (93-96
			ORION II (85-90
			ORION III (90-9
			P 100 (87-92)
			SIERRA (87-93)
		OPEL	ARENA (97-01)
			MOVANO A (98-)
		PEUGEOT	106 I (91-96)
		RENAULT	MASTER I (80-98
			TRAFIC (80-89)
			TRAFIC (89-01)
		RENAULT TRUCKS	MASCOTT (99-10)
		ROVER	100
		VAUXHALL	ARENA (98-01)
			MOVANO I (A) (9
DG-005	-	AUDI	80 (8C, B4) (91
			100 (44, C3) (8
			100 (4A, C4) (9
			A3 (8L) (96-03)
			A4 (8D, B5) (94
			A4 (8E, B6) (00
			A6 (4A, C4) (94
			A6 (4B, C5) (97
			CABRIOLET (8G7)
		DACIA	DUSTER (10-)
			LOGAN I (04-)
			LOGAN MCV I (07
			SANDERO I (08-)
		FORD	GALAXY (95-06)
		GAZ	GAZELLE (93-01)
		MITSUBISHI	CARISMA (95-06)
			SPACE STAR (98-
		NISSAN	ALMERA II (00-)
			INTERSTAR (02-)
			KUBISTAR (03-)
			MICRA III (03-1
			NOTE (06-)
			NV200 (10-)
			PRIMASTAR (01-)
			PRIMERA (02-)
			QASHQAI (+2) (0
			TIIDA (04-)
			TRADE (93-98)
			TRADE (96-04)
		NISSAN CV	ATLEON
			CABSTAR E
			ECO-T
		OPEL	MOVANO A (98-)
			VIVARO A (01-)
		RENAULT	CLIO II (98-)
			CLIO III (05-)
			ESPACE III (96-
			ESPACE IV (02-)
			GRAND SCÉNIC II

DENSO P/N	TT	MAKE	MODEL
DG-005	-		KANGOO (97-)
<i>continued</i>			KANGOO (08-)
			LAGUNA I (93-01)
			LAGUNA II (01-)
			LAGUNA III (07-)
			LOGAN I (04-)
			MASTER II (98-)
			MEGANE I (96-03)
			MEGANE II (02-)
			MODUS (04-)
			SCÉNIC I (99-03)
			SCÉNIC II (03-)
			THALIA I (98-)
			THALIA II (08-)
			TRAFIC II (01-)
			TWINGO II (07-)
		SEAT	ALHAMBRA (7V) (
			AROSA (6H) (97-
			CORDOBA (6K1) (
			CORDOBA (6K2) (
			IBIZA II (6K1)
			IBIZA III (6K2)
			IBIZA IV (6L) (
			INCA (6K9) (95-
			LEON (1M) (99-0
			TOLEDO I (1L) (
			TOLEDO II (1M)
		SKODA	FABIA (6Y) (99-
			OCTAVIA (1U) (9
		SUZUKI	GRAND VITARA (0
			JIMNY (98-)
		VAUXHALL	MOVANO I (A) (9
			VIVARO (A) (01-
		VOLVO	850 (91-97)
			S70 (96-00)
			S80 I (98-06)
			V70 I (96-00)
			V70 II (00-07)
		VW	BORA (1J) (98-0
			CADDY II (9K, 9
			GOLF III (1H, 1
			GOLF IV (1J, 1E
			LT 28-35 II (2D
			LT 28-46 II (2D
			LUPO (6X, 6E) (
			NEW BEETLE (9C,
			PASSAT (3A2, 35
			PASSAT (3B2, 3B
			PASSAT (3B3, 3B
			POLO (6N1) (94-
			POLO (6N2) (99-
			POLO (9N) (01-0
			POLO Classic (6
			POLO Saloon (9A
			POLO Variant (6
			SHARAN (7M) (95
			TRANSPORTER IV
			VENTO (1H2) (91
DG-006	-	VOLVO	340-360 (75-91)
DG-007	-	FORD	ESCORT VII (95-
			FIESTA IV (95-0
			MONDEO II (96-0
		MAZDA	121 III (96-03)
DG-008	-	DACIA	SOLENZA (03-)
		OPEL	ARENA (97-01)
		RENAULT	CLIO II (98-)
			KANGOO (97-)
			MEGANE Scénic (
			THALIA I (98-)
			TRAFIC (89-01)
		VAUXHALL	ARENA (98-01)

DENSO P/N	TT	MAKE	MODEL
DG-009	-	RENAULT	CLIO I (90-98)
			MEGANE I (96-03
			MEGANE Scénic (
DG-010	-	DAEWOO	KORANDO (99-)
			MUSSO (99-)
			REXTON (02-)
		MERCEDES-BENZ	100 (631) (88-9
			190 (W201) (82-
			C-CLASS (202) (
			E-CLASS (124) (
			G-CLASS (W460)
			G-CLASS (W461)
			G-CLASS (W463)
			KOMBI (S124) (8
			Saloon (W124) (
			S-CLASS (W140)
			SPRINTER 2-t (9
			SPRINTER 3-t (9
			SPRINTER 4-t (9
			T1 (601) (77-96
			T1 (602) (77-96
			T1
			T2
			V-CLASS (638
			VITO (638) (96-
		MERCEDES-BENZ CV	O 100
			UNIMOG
		PUCH	G-MODELL (W460)
			G-MODELL (W461)
			G-MODELL (W463)
		RENAULT	MEGANE I (96-03
		SSANGYONG	KORANDO (96-)
			MUSSO (93-)
			REXTON (02-)
DG-012	-	ARO	10 (80-06)
		AUDI	80 (81, 85, B2)
			80 (89, 8A, B3)
			80 (8C, B4) (91
			90 (89, 8A, B3)
			100 (43, C2) (7
			100 (44, C3) (8
			100 (4A, C4) (9
		BEDFORD	BLITZ (69-87)
		FORD	TRANSIT (77-86)
		MITSUBISHI	CARISMA (95-06)
		MULTICAR CV	M25
			M26
		NISSAN	BLUEBIRD (80-86
			LAUREL (81-85)
			LAUREL (84-89)
		RENAULT	19 I (88-92)
			19 II (92-01)
			MEGANE I (96-03
			MEGANE Scénic (
		SEAT	CORDOBA (6K1) (
			IBIZA II (6K1)
			INCA (6K9) (95-
			TERRA (87-96)
			TOLEDO I (1L) (
		SKODA	FELICIA Fun (97
			FELICIA I (6U)
			FELICIA II (6U)
		VOLVO	240 (74-93)
			440 (88-96)
			460 (88-96)
			740 (83-92)
			760 (81-92)
			940 I (90-95)
			940 II (94-98)
			960 I (90-94)
			S40 I (95-03)

Spark & Glow Plugs

Buyers Guide

DENSO P/N	TT	MAKE	MODEL
DG-012	-		V40 (95-04)
<i>continued</i>		VW	CADDY I (14) (8) CADDY II (9K, 9) GOLF I (17, 155) GOLF II (19, 1G) GOLF III (1H, 1) JETTA I (16) (7) JETTA II (19, 1) LT 28-35 I (281) LT 40-55 I (75- PASSAT (3A2, 35 PASSAT (32, 33) PASSAT (32B) (8) POLO (6N1) (94- POLO (6N2) (99- POLO (86C, 80) POLO Classic (6 SANTANA (81-85) TRANSPORTER III TRANSPORTER IV VENTO (1H2) (91)
DG-101	-	CARBODIES	FX4R (82-85)
		FORD	FOCUS I (98-05)
		HONDA	ACCORD V (93-98 ACCORD VI (97-0 CIVIC VI (94-01)
		LAND ROVER	FREELANDER I (9
		MG	MG ZR (01-05) MG ZS (01-05)
		RENAULT	ESPACE III (96- LAGUNA I (93-01 MEGANE I (96-03 MEGANE Scénic (SAFRANE II (96- SCÉNIC I (99-03
		ROVER	25 (99-05) 45 (00-05) 200 (RF) (95-00 400 (95-00) 600 (93-99) STREETWISE (03-
		VOLVO	S40 I (95-03) V40 (95-04)
DG-102	-	FIAT	BRAVA (95-02) BRAVO I (95-01) MAREA (96-07)
		LANCIA	DELTA II (93-99 KAPPA (94-01)
		TOYOTA	COROLLA (E12) (
DG-104	-	ISUZU	GEMINI (88-90) MIDI (88-) TROOPER (91-98)
		OPEL	ASTRA F (91-01) CAMPO (87-) CORSA A (82-93) KADETT E (84-94 MONTEREY A (91-
		VAUXHALL	ASTRA II (84-94 ASTRA III (F) (BRAVA (88-02) MONTEREY I (91- NOVA (82-94)
DG-106	-	MERCEDES-BENZ	C-CLASS (202) (E-CLASS (124) (E-CLASS (210) (G-CLASS (W463) S-CLASS (W140)
		PUCH	G-MODELL (W463)
DG-108	-	ISUZU	KB (10-) TROOPER (83-91)
		LANDWIND (JMC)	LANDWIND (05-)

DENSO P/N	TT	MAKE	MODEL
DG-108	-	OPEL	CAMPO (87-) FRONTERA A (92- VAUXHALL BRAVA (88-02) FRONTERA I (A)
DG-109	-	AUDI	A2 (8Z) (00-05) A3 (8L) (96-03) A4 (8E, B6) (00 A6 (4B, C5) (97
		CHRYSLER	VOYAGER (95-01)
		FORD	GALAXY (95-06) SCORPIO II (94-
		JEEP	GRAND CHEROKEE GRAND CHEROKEE
		OPEL	FRONTERA A (92-
		SEAT	ALHAMBRA (7V) (AROSA (6H) (97- CÓRDOBA (6L) (0 IBIZA IV (6L) (LEON (1M) (99-0 TOLEDO II (1M)
		SKODA	FABIA (6Y) (99- FABIA (06-14) OCTAVIA (1U) (9 ROOMSTER (5J) (SUPERB (3U) (01
		VAUXHALL	FRONTERA I (A)
		VW	BORA (1J) (98-0 CADDY III (2K, FOX (5Z) (03-) GOLF IV (1J, 1E LUPO (6X, 6E) (MULTIVAN V (7H, NEW BEETLE (9C, PASSAT (3B2, 3B PASSAT (3B3, 3B PHAETON (3D) (0 POLO (9N) (01-0 POLO Saloon (9A SHARAN (7M) (95 TOUAREG (7L) (0 TRANSPORTER V (
DG-110	-	MERCEDES-BENZ	E-CLASS (210) (SPRINTER 2-t (9 SPRINTER 3-t (9 SPRINTER 4-t (9 VARIO (96-)
DG-111	-	CITROËN	JUMPER (94-02) JUMPER (02-)
		FIAT	DUCATO (94-02) DUCATO (02-)
		IVECO	DAILY I (78-89) DAILY II (89-99 DAILY III (97-0
		PEUGEOT	BOXER (94-02) BOXER (02-)
		RENAULT	MASTER II (98-)
DG-112	-	RENAULT	CLIO II (98-) KANGOO (97-) MEGANE I (96-03 MEGANE Scénic (SCÉNIC I (99-03
DG-113	-	CITROËN	BERLINGO (MF) (C1 I (05-) C2 (03-) C3 I (02-) C3 Pluriel (03- C4 Coupe (04-) C4 I (LC) (04-) C5 II (04-) XSARA (97-05) XSARA Picasso (

DENSO P/N	TT	MAKE	MODEL
DG-113	-	FORD	FIESTA V (01-08)
<i>continued</i>			FOCUS C-MAX (03)
			FOCUS II (04-)
			FUSION (02-)
		MAZDA	2 (03-)
			3 (00-09)
			3 (09-)
		PEUGEOT	107 (05-)
			206 (98-)
			206 CC (00-)
			307 (00-)
			407 (04-)
			1007 (05-)
			PARTNER
		SUZUKI	LIANA (01-)
			SX4 (06-)
		TOYOTA	AYGO (05-)
		VOLVO	C30 (06-12)
			S40 II (04-)
			S80 II (06-)
			V50 (04-)
			V70 III (07-)
DG-114	-	ASIA MOTORS	ROCSTA (89-99)
		FORD	ECONOVAN (85-92)
		MAZDA	626 II (82-87)
			E-SERIE (SD) (8)
			E-SERIE (SR) (8)
DG-115	-	LAND ROVER	DEFENDER (90-)
			DISCOVERY I (89)
			DISCOVERY II (9)
DG-116	-	CITROËN	BERLINGO (MF) (
			C4 Coupe (04-)
			C4 I (LC) (04-)
			C5 I (01-04)
			C8 (02-)
			EVASION (94-02)
			JUMPER (94-02)
			JUMPER (02-)
			JUMPY (95-)
			XANTIA (98-03)
			XSARA (97-05)
			XSARA Picasso (
		FIAT	DUCATO (94-02)
			DUCATO (02-)
			SCUDO (96-06)
			SCUDO (07-)
			ULYSSE (94-02)
			ULYSSE (02-11)
		LANCIA	PHEDRA (02-10)
			ZETA (95-02)
		PEUGEOT	206 (98-)
			306 (93-02)
			307 (00-)
			406 (95-04)
			607 (00-)
			806 (94-02)
			807 (02-)
			BOXER (94-02)
			BOXER (02-)
			EXPERT (96-)
			PARTNER
		SUZUKI	GRAND VITARA (9
			GRAND VITARA (0
			VITARA (88-99)
			VITARA (03-05)
DG-117	-	CHRYSLER	PT CRUISER (00-
		MERCEDES-BENZ	C-CLASS (202) (
			C-CLASS (203) (
			C-CLASS Coupe (
			CLC (CL203) (08
			CLK (209) (02-1

DENSO P/N	TT	MAKE	MODEL
DG-117	-		E-CLASS (210) (
<i>continued</i>			E-CLASS (211) (
			G-CLASS (W463)
			M-CLASS (W163)
			S-CLASS (W220)
			SPRINTER 2-t (9
			SPRINTER 3,5 (9
			SPRINTER 3-t (9
			SPRINTER 3-t (9
			SPRINTER 4,6-t
			SPRINTER 4-t (9
			SPRINTER 5-t (9
			SPRINTER 5-t (9
			V-CLASS (638
			VIANO (W639) (0
			VITO (638) (96-
			VITO
DG-118	-	OPEL	ASTRA F CLASSIC
			ASTRA G (98-09)
			FRONTERA B (98-
			OMEGA B (94-03)
			SINTRA (96-99)
			VECTRA B (95-03
			ZAFIRA A (99-05
		SAAB	9-3 (98-03)
			9-5 (97-)
		VAUXHALL	ASTRA IV (G) (9
			FRONTERA II (B)
			OMEGA (B) (94-0
			SINTRA (96-99)
			VECTRA I (B) (9
			ZAFIRA I (A) (9
DG-119	-	MERCEDES-BENZ	C-CLASS (202) (
			E-CLASS (124) (
			E-CLASS (210) (
DG-121	-	FORD	C-MAX I (07-)
			FIESTA IV (95-0
			FOCUS C-MAX (03
			FOCUS I (98-05)
			FOCUS II (04-)
			GALAXY (06-)
			MONDEO IV (07-)
			S-MAX (06-)
			TOURNEO Connect
			TRANSIT CONNECT
DG-122	-	ALFA ROMEO	145
			147 (00-10)
			156 (97-06)
			159 (05-11)
			166 (98-07)
		FIAT	BRAVA (95-02)
			BRAVO I (95-01)
			CROMA (05-)
			DOBLO (01-)
			GRANDE PUNTO (0
			IDEA (03-)
			MAREA (96-07)
			MULTIPLA (99-10
			PUNTO (99-)
			STILO (01-08)
			STRADA (99-)
		LANCIA	KAPPA (94-01)
			LYBRA (99-05)
			MUSA (04-)
			THESIS (02-09)
		OPEL	ASTRA H (04-)
			SIGNUM (03-)
			VECTRA C (02-)
			ZAFIRA B (05-)
		SAAB	9-3 (02-)
		VAUXHALL	ASTRA V (H) (04

DENSO P/N	TT	MAKE	MODEL
DG-122	-		SIGNUM (02-08)
<i>continued</i>			VECTRA II (C) (
			ZAFIRA II (B) (
		VOLVO	S40 I (95-03)
			V40 (95-04)
DG-123	-	FORD	ESCORT III (80-
			ESCORT IV (85-9
			FIESTA II (83-9
			ORION I (83-86)
			ORION II (85-90
DG-124	-	ISUZU	CAMPO (77-91)
			GEMINI (88-90)
			TROOPER (83-91)
		OPEL	CAMPO (87-)
			CORSA A (82-93)
			VECTRA A (88-95
		SSANGYONG	KORANDO (88-96)
		VAUXHALL	BRAVA (88-02)
			CAVALIER III (8
			NOVA (82-94)
DG-126	-	NISSAN	INTERSTAR (02-)
			PRIMASTAR (01-)
		OPEL	MOVANO A (98-)
			VIVARO A (01-)
		RENAULT	AVANTIME (01-03
			ESPACE III (96-
			ESPACE IV (02-)
			LAGUNA II (01-)
			MASTER II (98-)
			TRAFIC II (01-)
			VEL SAVIS (02-)
		VAUXHALL	MOVANO I (A) (9
			VIVARO (A) (01-
DG-127	-	ALFA ROMEO	156 (97-06)
			159 (05-11)
			166 (98-07)
DG-129	-	FIAT	DOBLO (01-)
			PALIO (96-)
			PUNTO (99-)
			STRADA (99-)
DG-130	-	CITROËN	JUMPER (06-)
		FIAT	DUCATO (06-)
		FORD	MONDEO III (00-
			TRANSIT (00-06)
			TRANSIT (06-)
			TRANSIT TOURNEO
		JAGUAR	X-TYPE (01-09)
		LAND ROVER	DEFENDER (90-)
		LTI	TX (97-)
		PEUGEOT	BOXER (06-)
DG-132	-	FIAT	CROMA (85-96)
DG-133	-	OPEL	VECTRA B (95-03
		VAUXHALL	VECTRA I (B) (9
DG-137	-	FORD	MAVERICK (93-98
		LDV	CUB (98-01)
		NISSAN	SERENA (92-01)
			TERRANO I (87-9
			TERRANO II (92-
			TRADE (96-04)
			VANETTE CARGO (
		NISSAN CV	CABSTAR E
DG-139	-	VW	LT 28-35 II (2D
			LT 28-46 II (2D
DG-140	-	CITROËN	C5 III (08-)
			C6 (05-)
		JAGUAR	S-TYPE (99-08)
			XF (08-)
			XJ (03-09)
		LAND ROVER	DISCOVERY III (
			DISCOVERY IV (0
			RANGE ROVER III

DENSO P/N	TT	MAKE	MODEL
DG-140	-		RANGE ROVER SPO
<i>continued</i>		PEUGEOT	407 (04-)
			607 (00-)
		VOLVO	C70 II (06-)
			S60 I (00-10)
			S80 I (98-06)
			S80 II (06-)
			V50 (04-)
			V70 II (00-07)
			XC70 I Cross Co
			XC90 I (02-)
DG-142	-	OPEL	ASTRA G (98-09)
			FRONTERA B (98-
			OMEGA B (94-03)
			SIGNUM (03-)
			VECTRA B (95-03
			VECTRA C (02-)
			ZAFIRA A (99-05
		SAAB	9-3 (98-03)
			9-3 (02-)
			9-3X (09-)
		VAUXHALL	ASTRA IV (G) (9
			FRONTERA II (B)
			OMEGA (B) (94-0
			SIGNUM (02-08)
			VECTRA I (B) (9
			VECTRA II (C) (
			ZAFIRA I (A) (9
DG-143	-	ISUZU	GEMINI (88-90)
		OPEL	CORSA A (82-93)
		VAUXHALL	NOVA (82-94)
DG-144	-	AUDI	A4 (8D, B5) (94
			A4 (8E, B6) (00
			A4 (8E, B7) (04
			A4 Convertible
			A6 (4B, C5) (97
			A8 (4D) (94-02)
			A8 (4E) (02-10)
			ALLROAD (4BH) (
		SKODA	SUPERB (3U) (01
		VW	PASSAT (3B2, 3B
			PASSAT (3B3, 3B
DG-145	-	ALPINA	D10 (E39) (00-0
		BMW	3 (E46) (98-05)
			5 (E39) (95-04)
			7 (E38) (94-01)
			7 (E65, E66) (0
			X5 (E53) (00-)
		LAND ROVER	FREELANDER I (9
			RANGE ROVER III
		MG	MG ZT (01-05)
		OPEL	OMEGA B (94-03)
		ROVER	75 (99-05)
		VAUXHALL	MIDI I (84-88)
			OMEGA (B) (94-0
DG-146	-	FORD	RANGER (99-06)
			RANGER (06-)
		KIA	BESTA (96-)
			K2700 (99-)
			PREGIO (95-)
			RETONA (99-)
			SPORTAGE I (94-
		MAZDA	626 III (87-97)
			626 IV (91-97)
			B-SERIE (85-99)
			B-SERIE (99-)
			E-SERIE (SD) (8
			E-SERIE (SR) (8
			MPV I (95-99)
		SUZUKI	GRAND VITARA (9
DG-155	-	MERCEDES-BENZ	A-CLASS (W168)

DENSO P/N	TT	MAKE	MODEL
DG-155	-		VANEO (414) (02)
<i>continued</i>		MERCEDES-BENZ CV	UNIMOG
DG-157	-	NISSAN	PATROL (79-88) PATROL (84-96) PICK UP (80-86) PICK UP (85-98)
DG-159	-	BEDFORD	MIDI (84-92)
		OPEL	CORSA A (82-93) KADETT E (84-94)
		VAUXHALL	ASTRA II (84-94) MIDI II (88-97) NOVA (82-94)
DG-161	-	CITROËN	JUMPER (94-02)
		PEUGEOT	BOXER (94-02)
DG-162	-	MITSUBISHI	GALANT II (80-8) L 300 (80-87)
DG-170	-	ALFA ROMEO	147 (00-10) 156 (97-06) 159 (05-11) 166 (98-07) BRERA (06-) GT (03-10) SPIDER (06-)
		CADILLAC	BLS (06-)
		FIAT	BRAVO II (06-) CROMA (05-) STILO (01-08)
		LANCIA	THESIS (02-09)
		OPEL	ASTRA H (04-) SIGNUM (03-) VECTRA C (02-) ZAFIRA B (05-)
		SAAB	9-3 (02-) 9-5 (97-)
		VAUXHALL	ASTRA V (H) (04) SIGNUM (02-08) VECTRA II (C) () ZAFIRA II (B) ()
DG-171	-	ALFA ROMEO	MITO (08-)
		CITROËN	NEMO (08-)
		FIAT	500 (C) (07-) DOBLO (01-) DOBLO (10-) FIORINO (07-) GRANDE PUNTO (0) IDEA (03-) LINEA (07-) PANDA (03-) PANDA (12-) PUNTO (99-) PUNTO (12-) PUNTO EVO (08-1) QUBO (08-) SIENA (96-) STRADA (99-)
		FORD	KA (08-)
		LANCIA	MUSA (04-) YPSILON (843) ()
		OPEL	AGILA (00-07) AGILA (08-) ASTRA H (04-) COMBO (01-) CORSA C (00-09) CORSA D (06-) MERIVA A (03-10) TIGRA TwinTop ()
		PEUGEOT	BIPPER (08-)
		SUZUKI	IGNIS II (03-) SPLASH (08-) SWIFT III (05-) WAGON R+ (00-)

DENSO P/N	TT	MAKE	MODEL
DG-171	-	VAUXHALL	AGILA I (A) (00) AGILA II (B) (0) ASTRA V (H) (04) COMBO II (C) (0) CORSA II (C) (0) CORSA III (D) () MERIVA I (A) (0) TIGRA TwinTop ()
DG-172	-	HYUNDAI	GALLOPER (98-03) H-1 H100 (93-04)
		KIA	CARNIVAL I (99-) CARNIVAL II (99) CARNIVAL III (0) K2500 (03-)
DG-173	-	HYUNDAI	ACCENT II (99-0) ELANTRA (00-06) GETZ (02-09) GRANDEUR (05-) i30 (07-12) MATRIX (01-10) SANTA FÉ I (00-) SANTA FÉ II (06) SONATA V (05-) TRAJECT (00-08) TUCSON (04-10)
		KIA	CARENS II (02-) CARENS III (06-) CEED (06-) CERATO (04-) MAGENTIS (05-) PRO CEED (08-) SPORTAGE II (04)
DG-174	-	HYUNDAI	GALLOPER (91-98)
		KIA	CARNIVAL I (99-) CARNIVAL II (99) CARNIVAL III (0)
		MITSUBISHI	GALANT V (92-96) GALANT VI (96-0) L 200 (86-96) L 200 (96-07) L 300 (86-) L 300 (94-00) L 400 LANCER V (91-03) PAJERO Classic PAJERO II (90-0) PAJERO III (00-) PAJERO Sport I SPACE RUNNER (9) SPACE WAGON (91)
DG-175	-	CHEVROLET	C2500 (96-) TAHOE (94-96)
		HUMMER	HUMMER H1 (92-)
DG-176	-	CHRYSLER	VOYAGER (00-08)
		JEEP	CHEROKEE (01-08)
		LDV	MAXUS (05-09)
		LTI	TX (97-)
DG-177	-	AUDI	A2 (8Z) (00-05) A3 (8P) (03-13) A3 Convertible A4 (8E, B6) (00) A4 (8E, B7) (04)
		SEAT	ALTEA (XL) (5P) IBIZA V (6J) (0) LEON (1P) (05-) TOLEDO III (5P)
		SKODA	OCTAVIA (1Z) (0) SUPERB (3T) (08)
		VW	CADDY III (2K, CRAFTER 30-35 ()

DENSO P/N	TT	MAKE	MODEL
DG-177	-		CRAFTER 30-50 (
<i>continued</i>			EOS (1F) (06-)
			GOLF PLUS (5M,
			GOLF V (1K) (03
			GOLF VI (5K, 51
			JETTA III (1K2)
			MULTIVAN V (7H,
			PASSAT (3C) (05
			TOURAN (1T1, 1T
			TRANSPORTER V (
DG-178	-	ALPINA	D3 (E91) (05-)
		BMW	1 (E81, E87) (0
			3 (E46) (98-05)
			3 (E90, E91) (0
			3 (E92, E93) (0
			5 (E60, E61) (0
			6 (E63, E64) (0
			7 (E65, E66) (0
			X3 (E83) (04-)
			X5 (E53) (00-)
			X5 (E70) (07-13
			X6 (E71, E72) (
DG-180	-	CITROËN	BERLINGO (B9) (
			BERLINGO (MF) (
			C2 (03-)
			C3 I (02-)
			C3 II (09-)
			C3 Picasso (09-
			C4 (Grand) Pica
			C4 Coupe (04-)
			C4 I (LC) (04-)
			C4 II (B7) (09-
			C5 II (04-)
			C5 III (08-)
			JUMPY (07-)
			NEMO (08-)
		FIAT	SCUDO (07-)
		FORD	C-MAX I (07-)
			FIESTA V (01-08
			FIESTA VI (08-)
			FOCUS II (04-)
			FUSION (02-)
		MAZDA	2 (07-)
			3 (09-)
		MINI	MINI (R56) (06-
			MINI Clubman (R
		PEUGEOT	206 (98-)
			206+ (09-)
			207 (06-)
			308 I (07-)
			407 (04-)
			1007 (05-)
			3008 (09-)
			5008 (09-)
			BIPPER (08-)
			EXPERT (07-)
			PARTNER
			PARTNER
		VOLVO	C30 (06-12)
			S40 II (04-)
			S80 II (06-)
			V50 (04-)
			V70 III (07-)
DG-181	-	CITROËN	C3 Picasso (09-
			C4 (Grand) Pica
			C4 Aircross (12
			C4 Coupe (04-)
			C4 I (LC) (04-)
			C4 II (B7) (09-
			C5 I (01-04)
			C5 II (04-)

DENSO P/N	TT	MAKE	MODEL
DG-181	-		C5 III (08-)
<i>continued</i>			C8 (02-)
			DS3 (09-)
			DS4 (11-)
			JUMPY (95-)
			JUMPY (07-)
		FIAT	SCUDO (07-)
			ULYSSE (02-11)
		FORD	C-MAX I (07-)
			FOCUS C-MAX (03
			FOCUS II (04-)
			GALAXY (06-)
			KUGA I (08-)
			MONDEO IV (07-)
			S-MAX (06-)
		LANCIA	PHEDRA (02-10)
		PEUGEOT	308 I (07-)
			407 (04-)
			508 (10-)
			607 (00-)
			807 (02-)
			EXPERT (07-)
			PARTNER
		VOLVO	C30 (06-12)
			C70 II (06-)
			S40 II (04-)
			S80 II (06-)
			V50 (04-)
			V70 III (07-)
DG-182	-	LAND ROVER	DEFENDER (90-)
			DISCOVERY II (9
DG-183	-	VW	LT 28-35 II (2D
			LT 28-46 II (2D
DG-184	-	SMART	CABRIO (450) (0
			CITY-Coupe (450
			FORTWO (450) (0
			FORTWO (451) (0
DG-186	-	ISUZU	TROOPER (00-)
		OPEL	MONTEREY B (98-
		VAUXHALL	MONTEREY II (98
DG-187	-	MITSUBISHI	CANTER (01-10)
			PAJERO Classic
			PAJERO III (00-
		MITSUBISHI CV	Canter
DG-188	-	SSANGYONG	KYRON (05-)
			REXTON (02-)
			RODIUS I (05-)
DG-189	-	HYUNDAI	H-1
			H-1 (08-)
		KIA	SORENTO I (02-)
DG-190	-	AUDI	A3 (8P) (03-13)
			A4 (8E, B7) (04
			A6 (4F, C6) (04
		CHRYSLER	SEBRING (07-10)
		DODGE	AVENGER (07-)
			CALIBER (06-)
			JOURNEY (08-)
		JEEP	COMPASS (06-)
			PATRIOT (07-)
		MITSUBISHI	GRANDIS (04-)
			LANCER (07-)
			OUTLANDER II (0
		SEAT	ALTEA (XL) (5P)
			LEON (1P) (05-)
			TOLEDO III (5P)
		SKODA	OCTAVIA (1Z) (0
			SUPERB (3T) (08
		VW	GOLF PLUS (5M,
			GOLF V (1K) (03
			JETTA III (1K2)
			PASSAT (3C) (05

DENSO P/N	TT	MAKE	MODEL
DG-190	-		TOURAN (1T1, 1T
<i>continued</i>			
DG-191	-	BMW	7 (E65, E66) (0
DG-192	-	MERCEDES-BENZ	C-CLASS (203) (C-CLASS Coupe (
DG-193	-	AUDI	A1 (8X) (10-) A3 (8P) (03-13) A3 (8V) (12-) A3 Convertible A4 (8E, B7) (04 A4 (8K, B8) (07 A4 Allroad (8KH A4 Convertible A5 (8T, 8F) (07 A6 (4F, C6) (04 A6 (4G, C7) (10 A6 Allroad (4FH A6 Allroad (4GH A7 (4GA) (10-) A8 (4E) (02-10) A8 (4H) (09-) Q3 (8U) (11-) Q5 (8R) (08-) Q7 (4L) (06-) TT (8J) (06-14)
		PORSCHE	CAYENNE (955) (CAYENNE (10-)
		SEAT	ALHAMBRA (710) ALTEA (XL) (5P) EXEO (3R) (08-) IBIZA V (6J) (0 LEON (1P) (05-) LEON (5F) (12-) TOLEDO III (5P) TOLEDO IV (KG3)
		SKODA	FABIA (06-14) OCTAVIA (1Z) (0 OCTAVIA (5E) (1 RAPID (HN) (12- ROOMSTER (5J) (SUPERB (3T) (08 YETI (5L) (09-)
		VW	AMAROK (10-) BEETLE (5C) (11 CADDY III (2K, CC (358) (11-) CRAFTER 30-35 (CRAFTER 30-50 (EOS (1F) (06-) GOLF PLUS (5M, GOLF V (1K) (03 GOLF VI (5K, 51 GOLF VII (5G, B JETTA III (1K2) JETTA IV (162) MULTIVAN V (7H, PASSAT (3C) (05 PASSAT (362, 36 PASSAT CC (357) PHAETON (3D) (0 POLO (6R, 6C) (SCIROCCO (137) SHARAN (7N) (10 TIGUAN (5N) (07 TOUAREG (7L) (0 TOUAREG (7P) (1 TOURAN (1T1, 1T TOURAN (1T3) (1 TRANSPORTER V (
DG-194	-	CHRYSLER	300 C (04-12)
		JEEP	COMMANDER (05-1

DENSO P/N	TT	MAKE	MODEL
DG-194	-		GRAND CHEROKEE
<i>continued</i>			GRAND CHEROKEE GRAND CHEROKEE
		MERCEDES-BENZ	A-CLASS (W169) B-CLASS (W245) C-CLASS (203) (C-CLASS (204) (CLK (209) (02-1 CLS (C219) (04- E-CLASS (211) (GL-CLASS (X164) GLK (X204) (08- M-CLASS (W164) R-CLASS (251) (S-CLASS (W221) SPRINTER 3.5 (9 SPRINTER 3-t (9 SPRINTER 4.6-t SPRINTER 5-t (9 VIANO (W639) (0 VITO
DG-195	-	CITROËN	JUMPER (06-)
		FIAT	DUCATO (02-) DUCATO (06-)
		IVECO	DAILY III (97-0 DAILY IV (06-) DAILY V (11-) MASSIF (08-)
		PEUGEOT	BOXER (06-)
DG-196	-	ALFA ROMEO	147 (00-10)
		FIAT	BRAVO II (06-) CROMA (05-) DOBLO (01-) SEDICI (06-) STILO (01-08)
		OPEL	ASTRA H (04-) SIGNUM (03-) VECTRA C (02-) ZAFIRA B (05-)
		SAAB	9-3 (02-)
		SUZUKI	SX4 (06-)
		VAUXHALL	ASTRA V (H) (04 SIGNUM (02-08) VECTRA II (C) (ZAFIRA II (B) (
DG-197	-	NISSAN	ALMERA II (00-) ALMERA TINO (00 NAVARA (D40) (0 NP300 (08-) PATHFINDER (05- PICK UP (D22) (PRIMERA (02-) X-TRAIL (01-)
		NISSAN CV	CABSTAR
DG-198	-	ALFA ROMEO	GIULIETTA (77-8
		HYUNDAI	GALLOPER (91-98 GALLOPER (98-03 H-1
		LTI	TX (97-)
		MITSUBISHI	COLT II (84-88) COLT III (88-92 GALANT III (84- GALANT IV (87-9 L 300 (80-87) LANCER III (83- PAJERO I (82-91 SPACE WAGON (83 SPACE WAGON (91
		NISSAN	PATHFINDER (97- PATROL GR I (87 PICK UP (D22) (

DENSO P/N	TT	MAKE	MODEL
DG-198	-		PICK UP (85-98)
<i>continued</i>			URVAN (81-98)
		NISSAN CV	CABSTAR
DG-202	-	ALFA ROMEO	33 (83-93)
			33 (90-94)
			75 (85-92)
			90 (84-87)
			164 (87-98)
			ALFETTA (74-84)
			AR 6 (79-89)
		LAND ROVER	RANGE ROVER I (
		ROVER	2000-3500 (76-8
DG-211	-	TOYOTA	4 RUNNER (N10)
			CRESSIDA (80-93
			CROWN (80-85)
			DYNA 150 (95-01
			DYNA (87-01)
			HIACE I (77-85)
			HIACE II (83-89
			HIACE III (87-0
			HIACE IV (95-)
			HILUX II (83-05
			LAND CRUISER
			STARLET (P8) (8
			TOYOACE (79-85)
		VW	TARO (89-97)
DG-212	-	TOYOTA	DYNA 150 (95-01
			HIACE III (87-0
DG-213	-	TOYOTA	CRESSIDA (80-93
			LAND CRUISER
DG-214	-	TOYOTA	AVENSIS (97-03)
			CAMRY (86-91)
			CARINA E (92-97
			CARINA II (83-9
			COROLLA (E8) (8
			COROLLA (E9) (8
			COROLLA (E10) (
			COROLLA (E11) (
			COROLLA FX (84-
			LAND CRUISER (J
			LAND CRUISER (J
			LAND CRUISER (J
			LAND CRUISER (J
			LITEACE (84-92)
			LITEACE (92-97)
DG-215	-	TOYOTA	DYNA 150 (85-88
			DYNA (77-87)
			HIACE I (77-85)
			HIACE II (83-89
			HILUX II (83-05
			LAND CRUISER
			STARLET (P7) (8
DG-216	-	DAIHATSU	CHARADE III (87
DG-218	-	TOYOTA	HIACE IV (95-)
DG-219	-	TOYOTA	DYNA 150 (88-95
			LAND CRUISER (J
			LAND CRUISER (J
			LAND CRUISER
DG-220	-	TOYOTA	LAND CRUISER (J
			LAND CRUISER (J
			LAND CRUISER
DG-221	-	TOYOTA	HIACE I (77-85)
			HILUX II (83-05
DG-222	-	DAIHATSU	DELTA (84-87)
			DELTA Wide (84-
		TOYOTA	LAND CRUISER (J
			LAND CRUISER
DG-223	-	DAIHATSU	CHARADE II (83-
			DELTA Wide (84-
			ROCKY (85-98)
			RUGGER (84-93)

DENSO P/N	TT	MAKE	MODEL
DG-223	-		TAFT (76-85)
<i>continued</i>			WILDCAT
		TOYOTA	CAMRY (83-88)
			CARINA (73-83)
			CARINA II (83-9
			COROLLA (E7) (7
			COROLLA (E8) (8
			COROLLA FX (84-
			LITEACE (79-86)
			LITEACE (84-92)
			MODELL F (82-90
DG-224	-	TOYOTA	LAND CRUISER (J
DG-228	-	TOYOTA	HEAVY DUTY TRUC
DG-231	-	TOYOTA	HEAVY DUTY TRUC
DG-233	-	TOYOTA	LAND CRUISER (J
			LAND CRUISER (J
			LAND CRUISER
DG-234	-	DAIHATSU	TAFT (76-85)
DG-238	-	TOYOTA	TOYOACE (79-85)
DG-240	-	MINI	MINI (R50, R53)
		SUBARU	TREZIA (11-)
		TOYOTA	AURIS (06-)
			AURIS (12-)
			COROLLA (E12) (
			COROLLA (E14, E
			ECHO (99-05)
			IQ (09-)
			URBAN CRUISER (
			VERSO S (10-)
			YARIS (99-05)
			YARIS (05-)
			YARIS (10-)
			YARIS VERSO (99
DG-241	-	TOYOTA	DYNA (77-87)
DG-242	-	TOYOTA	DYNA 150 (95-01
			DYNA (01-)
			HIACE IV (95-)
DG-245	-	TOYOTA	AVENSIS (97-03)
			AVENSIS (03-09)
			AVENSIS Verso (
			COROLLA (E11) (
			COROLLA (E12) (
			COROLLA Verso (
			DYNA (01-)
			HIACE III (87-0
			HIACE IV (95-)
			HIACE V (05-)
			HILUX II (83-05
			HILUX III (05-)
			LAND CRUISER
			LAND CRUISER
			LAND CRUISER
			PREVIA II (00-0
			RAV 4 II (00-05
DG-300	-	OPEL	ASTRA F (91-01)
			COMBO (94-01)
			CORSA B (93-00)
			VECTRA A (88-95
			VECTRA B (95-03
		VAUXHALL	ASTRA III (F) (
			CAVALIER III (8
			COMBO I (B) (94
			CORSA I (B) (93
			VECTRA I (B) (9
DG-301	-	HYUNDAI	GALLOPER (98-03
			TERRACAN (01-06
		KIA	PREGIO (95-)
		MITSUBISHI	GALLOPER (98-03
			LANCER III (83-
			LANCER IV (88-9
		PROTON	PERSONA 400 (94

DENSO P/N	TT	MAKE	MODEL
DG-302	-	HONDA	CIVIC VII (00-0)
		OPEL	ASTRA G (98-09)
			ASTRA H (04-)
			ASTRA J (09-)
			COMBO (01-)
			CORSA C (00-09)
			CORSA D (06-)
			MERIVA A (03-10)
			MERIVA B (10-)
			ZAFIRA B (05-)
			VAUXHALL
		ASTRA V (H) (04	
		ASTRA VI (J) (0	
		COMBO II (C) (0	
		CORSA II (C) (0	
		CORSA III (D) (
		MERIVA I (A) (0	
NISSAN	ALMERA I (95-00		
	AVENIR (92-97)		
	PRIMERA (90-98)		
	PRIMERA (96-02)		
	SUNNY III (90-0		
DAIHATSU	DELTA Wide (84-		
	TOYOTA	4 RUNNER (N18)	
		LAND CRUISER	
LAND CRUISER			
MITSUBISHI	CANTER (96-01)		
	PAJERO II (90-0		
	PAJERO Sport I		
MITSUBISHI CV	Canter		
	NISSAN	PATROL (84-96)	
		PATROL GR II (9	
NISSAN	BLUEBIRD (85-92		
	LAUREL (84-89)		
	SERENA (92-01)		
	SUNNY II (86-91		
	SUNNY III (90-0		
	TRADE (93-98)		
	VANETTE (86-95)		
	VANETTE CARGO (
	TOYOTA	CROWN (91-99)	
		CROWN (99-03)	
HILUX II (83-05			
MARK II (80-01)			
FORD	RANGER (99-06)		
	MAZDA	323 C IV (89-00	
323 III (85-95)			
323 S IV (89-94			
323 S V (94-98)			
B-SERIE (99-)			
OPEL	SIGNUM (03-)		
	VECTRA C (02-)		
	RENAULT	ESPACE IV (02-)	
		VEL SATIS (02-)	
	SAAB	9-5 (97-)	
	VAUXHALL	SIGNUM (02-08)	
		VECTRA II (C) (
MAZDA	3 (00-09)		
	5 (05-)		
	6 (02-07)		
	323 F VI (98-04		
	323 P V (96-)		
	323 S V (94-98)		
	323 S VI (98-04		
	626 V (97-02)		
	MPV II (99-06)		
	PREMACY (99-05)		

DENSO P/N	TT	MAKE	MODEL
DG-600	-	LEXUS	IS II (05-)
		TOYOTA	AURIS (06-)
			AVENSIS (03-09)
			AVENSIS (09-)
			COROLLA (E14, E
			COROLLA Verso (
			LAND CRUISER (J
			RAV 4 III (05-)
			RAV 4 IV (12-)
			VERSO (09-)
			HONDA
		ACCORD VIII (08	
CIVIC VIII Hatc			
CR-V II (01-06)			
CR-V III (06-)			
HYUNDAI	ACCENT III (05-		
	ELANTRA (00-06)		
	ELANTRA (11-)		
	GETZ (02-09)		
	i10 (07-)		
	i20 (08-)		
	i30 (07-12)		
	i30 (11-)		
	i30 Coupe (13-)		
	ix20 (10-)		
	MATRIX (01-10)		
	KIA	CARENS III (06-	
		CARENS IV (13-)	
		CEED (06-)	
		CEED (12-)	
		CERATO (04-)	
		OPTIMA (11-)	
PICANTO (04-)			
PRO CEED (08-)			
PRO CEED (13-)			
RIO II (05-)			
RIO III (11-)			
SOUL I (09-)			
SOUL II (14-)			
SPORTAGE III (1			
VENGA (10-)			
CITROËN	BERLINGO (B9) (
	C3 II (09-)		
	C3 Picasso (09-		
	C4 (Grand) Pica		
	C4 (Grand) Pica		
	C4 Cactus (14-)		
	C4 II (B7) (09-		
	C5 III (08-)		
	C8 (02-)		
	C-ELYSEE (12-)		
	DS3 (09-)		
	DS4 (11-)		
	DS5 (11-)		
	JUMPY (07-)		
	FORD	B-MAX (12-)	
		C-MAX II (10-)	
		ECOSPORT (13-)	
		FIESTA VI (08-)	
		FOCUS III (11-)	
		GALAXY (06-)	
		GALAXY (15-)	
		GRAND C-MAX (10	
		KUGA II (13-)	
MONDEO IV (07-)			
MONDEO V (14-)			
S-MAX (06-)			
TOURNEO			
TOURNEO Courier			
TRANSIT Connect			

DENSO P/N	TT	MAKE	MODEL
DG-603	-		TRANSIT Courier
<i>continued</i>		MAZDA	2 (07-) 5 (10-)
		PEUGEOT	207 (06-) 208 (12-) 301 (12-) 308 I (07-) 308 II (13-) 407 (04-) 508 (10-) 807 (02-) 2008 (13-) 3008 (09-) 4008 (12-) 5008 (09-) EXPERT (07-) PARTNER RCZ (10-)
		VOLVO	C30 (06-12) S40 II (04-) S60 II (10-) S80 II (06-) V40 (12-) V60 (10-)
DG-604	-	CHEVROLET	CAPTIVA (06-) CRUZE (09-) EPICA (05-) LACETTI (05-) NUBIRA (05-)
		OPEL	ANTARA (06-)
		VAUXHALL	ANTARA (06-)
DG-605	-	NISSAN	PATROL GR II (9) TERRANO II (92-)
		OPEL	MOVANO A (98-)
		RENAULT	MASTER II (98-)
		RENAULT TRUCKS	MASCOTT (99-10)
DG-606	-	MITSUBISHI	COLT VI (04-)
		SMART	FORFOUR (454) (
DG-607	-	MINI	MINI (R56) (06-) MINI Clubman (R MINI Convertibl MINI Countryman MINI Coupe (R58 MINI Paceman (R MINI Roadster (
DG-608	-	ALFA ROMEO	159 (05-11) BRERA (06-) GIULIETTA (10-) MITO (08-) SPIDER (06-)
		CADILLAC	BLS (06-)
		CHRYSLER	DELTA (11-)
		FIAT	500L (12-) BRAVO II (06-) DOBLO (10-) DUCATO (06-) FREEMONT (11-) GRANDE PUNTO (0 IDEA (03-) LINEA (07-) PUNTO EVO (08-1 SEDICI (06-)
		LANCIA	DELTA III (08-) MUSA (04-)
		OPEL	ASTRA J (09-) COMBO (12-) INSIGNIA (08-) ZAFIRA C (11-)
		SAAB	9-3 (02-) 9-5 (10-)
		SUZUKI	SX4 (06-)

DENSO P/N	TT	MAKE	MODEL
DG-608	-		SX4 S-Cross (13
<i>continued</i>		VAUXHALL	ASTRA VI (J) (0 COMBO III (D) (0 INSIGNIA (08-)
DG-609	-	DACIA	DOKKER (12-) DUSTER (10-) LODGY (12-) LOGAN I (04-) LOGAN II (12-) LOGAN MCV I (07 LOGAN MCV II (1 SANDERO I (08-) SANDERO II (12-)
		MERCEDES-BENZ	A-CLASS (W176) B-CLASS (W246) CITAN (415) (12 CLA Coupe (C117 GLA (X156) (13-
		NISSAN	CUBE (10-) JUKE (10-) NOTE (06-) NOTE (13-) NV200 (10-) QASHQAI (+2) (0 QASHQAI (13-)
		RENAULT	CAPTUR (13-) CLIO III (05-) CLIO IV (12-) DUSTER (09-) FLUENCE (10-) GRAND SCÉNIC II KANGOO (08-) LAGUNA III (07- LATITUDE (10-) MEGANE III (08- MODUS (04-) SCÉNIC III (09- THALIA III (13- TWINGO II (07-)
DG-610	-	VOLVO	C30 (06-12) C70 II (06-) S40 II (04-) S60 II (10-) S80 II (06-) V50 (04-) V60 (10-) V70 III (07-) XC60 (08-) XC70 II (07-) XC90 I (02-)
DG-614	-	CITROËN	C5 III (08-) C6 (05-) C8 (02-) C-CROSSER (07-)
		FORD	GALAXY (06-) MONDEO IV (07-) S-MAX (06-)
		LANCIA	PHEDRA (02-10)
		LAND ROVER	FREELANDER II (
		MITSUBISHI	OUTLANDER II (0
		PEUGEOT	407 (04-) 807 (02-) 4007 (07-)
DG-619	-	RENAULT	GRAND SCÉNIC II MEGANE III (08- SCÉNIC III (09-
DG-621	-	ALFA ROMEO	MITO (08-)
		CHEVROLET	AVEO (T300) (11
		FIAT	500 (C) (07-) 500L (12-) FIORINO (07-)

DENSO P/N	TT	MAKE	MODEL
DG-621	-		GRANDE PUNTO (0
<i>continued</i>			LINEA (07-)
			PUNTO (12-)
			PUNTO EVO (08-1
			QUBO (08-)
			STRADA (10-)
		LANCIA	MUSA (04-)
			YPSILON (846) (
		OPEL	ASTRA J (09-)
			COMBO (12-)
			CORSA D (06-)
			MERIVA B (10-)
		VAUXHALL	ASTRA VI (J) (0
			COMBO III (D) (
			MERIVA II (B) (
DG-702	-	NISSAN	PATROL GR II (9
DK20PR-D13	-	HONDA	CITY (08-)
			CR-Z (10-)
			JAZZ III (08-)
DXE22HQR-D11S	-	HONDA	ODYSSEY (RC1, R
DXU22HCR-D11S	-	HONDA	CIVIC IX (12-)
			ODYSSEY (02-)
FK16HBR-J8	-	TOYOTA	CAMRY (11-)
FK16HR-A8	-	TOYOTA	CAMRY (11-)
			PRIUS C (12-)
			YARIS (10-)
FK16R11	IK16TT	TOYOTA	SOLUNA Vios (02
FK16R-A8	-	TOYOTA	AQUA (11-)
FK20HBR11	IKB20TT	LEXUS	GS (05-11)
			GS (12-)
			IS C (09-)
			IS II (05-)
			IS III (13-)
			LS (06-)
		TOYOTA	AURION (00-11)
			CROWN (03-08)
			CROWN (08-12)
			CROWN (12-)
			MARK X I (04-09
			MARK X II (09-)
FK20HR11	IKH20TT	LEXUS	ES (06-12)
			ES (12-)
			GS (05-11)
			IS C (09-)
			RX (03-08)
			RX (08-)
		LOTUS	EVORA (09-)
			EXIGE (12-)
		SUBARU	IMPREZA (08-)
		TOYOTA	ALPHARD II (08-
			AURION (00-11)
			AURION (11-)
			AURIS (06-)
			AVALON (05-)
			CAMRY (01-06)
			CAMRY (06-11)
			CAMRY (11-)
			CROWN (03-08)
			CROWN (08-12)
			HARRIER (03-)
			KLUGER
			MARK X I (04-09
			MARK X ZIO (07-
			PREVIA II (00-0
			PREVIA III (05-
			RAV 4 III (05-)
			SIENNA (10-)
			VENZA (08-)
		TOYOTA (GAC)	HIGHLANDER (09-
FXE16HE11	-	NISSAN	LATIO (04-)
			TIDA (04-)

DENSO P/N	TT	MAKE	MODEL
FXE20HE11	IXEH20ETT	MITSUOKA	VIEWT (K12) (05
		NISSAN	JUKE (10-)
			LATIO (04-)
			MICRA IV (10-)
			TIDA (04-)
FXE20HR11	IXEH20TT	NISSAN	ALTIMA (06-)
			CUBE (10-)
			ELGRAND (10-)
			LATIO (04-)
			MICRA C+C (05-)
			MICRA III (03-1
			NOTE (06-)
			NV200 (10-)
			PRIMERA (02-)
			QASHQAI (+2) (0
			SERENA (05-)
			TEANA (08-)
			TIDA (04-)
			X-TRAIL (07-)
		RENAULT	CLIO III (05-)
			FLUENCE (10-)
			GRAND SCÉNIC II
			KOLEOS (08-)
			LAGUNA III (07-
			LATITUDE (10-)
			MEGANE III (08-
			SCÉNIC III (09-
		RENAULT SAMSUNG	QM5 (06-)
FXE24HR11	-	INFINITI	EX (08-)
			FX (03-)
			G (02-)
			M (10-)
			M37 (10-)
			QX70 (13-)
		NISSAN	370 Z (09-)
FXU16HR11	-	KIA	SORENTO II (09-
GX8-1	-	MITSUBISHI	LANCER (07-)
			LANCER EVO (92-
IK16	IK16TT	ALFA ROMEO	159 (05-11)
			BRERA (06-)
			SPIDER (06-)
		BENTLEY	CONTINENTAL (91
			TURBO R (88-98)
		DODGE	CALIBER (06-)
		ISUZU	D-MAX (02-)
			TROOPER (91-98)
			TROOPER (00-)
		LAND ROVER	DISCOVERY III (
		MAZDA	MX-3 (91-98)
		NISSAN	SKYLINE (R33) (
		PEUGEOT	205 II (87-98)
		SKODA	FABIA (6Y) (99-
IK16L	IK16TT	CHRYSLER	300 C (04-12)
		DODGE	NITRO (06-)
IK16TT	-	ALFA ROMEO	159 (05-11)
			BRERA (06-)
			SPIDER (06-)
		AUDI	A4 (8E, B6) (00
			A4 (8E, B7) (04
			A4 Convertible
			A8 (4D) (94-02)
		BENTLEY	CONTINENTAL (91
			TURBO R (88-98)
		BMW	3 (E30) (82-94)
			7 (E32) (86-94)
			8 (E31) (90-99)
		CADILLAC	BLS (06-)
		CHERY	QQ3 (03-)
			TIGGO (05-08)
		CHEVROLET	AVEO (T300) (11
			CAPTIVA (06-)

DENSO P/N	TT	MAKE	MODEL
IK16TT	-		CRUZE (09-)
<i>continued</i>			NIVA (2121) (02)
			VIVA (03-08)
		CHRYSLER	300 C (04-12)
			300 M (98-04)
			CIRRUS (94-00)
			SEBRING (07-10)
			STRATUS (95-01)
			VOYAGER (95-01)
		CITROËN	C-CROSSER (07-)
			XSARA (97-05)
			XSARA Picasso (
		DAIHATSU	CHARADE V (03-)
			CUORE VI (98-03)
			CUORE VII (03-)
			MOVE (94-)
			SIRION (98-05)
			TREVIS (06-)
			YRV (01-)
		DODGE	AVENGER (07-)
			CALIBER (06-)
			CARAVAN (95-02)
			JOURNEY (08-)
			NITRO (06-)
			STRATUS (95-01)
		FIAT	BRAVA (95-02)
			BRAVO I (95-01)
			CROMA (05-)
			DOBLO (01-)
			MAREA (96-07)
			MULTIPLA (99-10)
			PALIO (96-)
			PANDA (80-04)
			PANDA (03-)
			PUNTO (99-)
			SEICENTO (98-10)
			SIENA (96-)
			STILO (01-08)
			STRADA (99-)
		FORD	GALAXY (95-06)
		GEELY	BL (05-)
			CK (05-)
			MR (05-)
		HOLDEN	ASTRA G (TS) (9
			ASTRA H (AH) (0
			JACKAROO
			RODEO (78-)
		HONDA	ACCORD VI (97-0
			CAPA (98-02)
			CIVIC V (91-97)
			CIVIC VI (94-01)
			CIVIC VII (00-0
			CR-V I (95-02)
			HR-V (99-)
			LOGO (99-02)
			ODYSSEY (02-)
		HYUNDAI	ACCENT I (94-00
			ACCENT II (99-0
			ACCENT III (05-
			ATOS (98-)
			ATOS Prime (99-
			COUPE (96-02)
			COUPE (01-09)
			ELANTRA (00-06)
			ELANTRA (05-11)
			GETZ (02-09)
			GRANDEUR
			GRANDEUR (05-)
			HIGHWAY VAN (00
			i10 (07-)
			i30 (07-12)

DENSO P/N	TT	MAKE	MODEL
IK16TT	-		ix55 (08-)
<i>continued</i>			LANTRA II (95-0
			MATRIX (01-10)
			S COUPE (90-96)
			SANTA FÉ I (00-
			SANTA FÉ II (06
			SONATA IV (98-0
			SONATA V (05-)
			TERRACAN (01-06
			TIBURON (06-)
			TRAJECT (00-08)
			TUCSON (04-10)
		INFINITI	QX4 (97-)
		ISUZU	ASKA (95-01)
			D-MAX (02-)
			TROOPER (91-98)
			TROOPER (00-)
		JAGUAR	S-TYPE (99-08)
			XF (08-)
			XJ (97-03)
			XJ (03-09)
			XJ (09-)
			XK 8 (96-05)
			XK (06-14)
		JEEP	CHEROKEE (84-01
			CJ5 - CJ8 (66-8
			COMANCHE (86-96
			COMMANDER (05-1
			COMPASS (06-)
			GRAND CHEROKEE
			GRAND CHEROKEE
			PATRIOT (07-)
			WRANGLER I (86-
			WRANGLER II (96
		KIA	CARENS II (02-)
			CARENS III (06-
			CARNIVAL II (99
			CARNIVAL III (0
			CEED (06-)
			CERATO (04-)
			CLARUS (96-)
			MAGENTIS (01-)
			MAGENTIS (05-)
			OPIRUS (03-)
			PICANTO (04-)
			PRO CEED (08-)
			RIO II (05-)
			SEPHIA (93-97)
			SHUMA I (96-01)
			SHUMA II (01-04
			SORENTO I (02-)
			SPORTAGE I (94-
			SPORTAGE II (04
		LANCIA	DEDRA (89-99)
			LYBRA (99-05)
			Y (95-03)
			Y10 (85-95)
			YPSILON (843) (
		LAND ROVER	DISCOVERY II (9
			DISCOVERY III (
			RANGE ROVER II
			RANGE ROVER III
			RANGE ROVER SPO
		LANDWIND (JMC)	LANDWIND (05-)
		LOTUS	EUROPA S (06-)
		MAZDA	2 (03-)
			2 (07-)
			3 (00-09)
			3 (09-)
			121 II (90-97)
			323 C IV (89-00

DENSO P/N	TT	MAKE	MODEL
IK16TT	-		323 C V (94-98)
<i>continued</i>			323 F IV (87-94)
			323 F V (94-98)
			323 F VI (98-04)
			323 I (77-86)
			323 II (80-89)
			323 S IV (89-94)
			323 S V (94-98)
			323 S VI (98-04)
			626 III (87-97)
			626 IV (91-97)
			929 III (87-91)
			B-SERIE (85-99)
			DEMIO (98-03)
			MPV I (95-99)
			MPV II (99-06)
			MX-3 (91-98)
			MX-5 II (98-05)
			MX-6 (92-97)
			PREMACY (99-05)
			VERISA (04-)
			XEDOS 6 (92-99)
			XEDOS 9 (93-02)
		MERCEDES-BENZ	C-CLASS (202) (
			C-CLASS (203) (
			C-CLASS Coupe (
			CLK (208) (97-0
			CLK (209) (02-1
			CLS (C219) (04-
			E-CLASS (124) (
			E-CLASS (210) (
			E-CLASS (211) (
			G-CLASS (W463)
			M-CLASS (W163)
			M-CLASS (W164)
			R-CLASS (251) (
			S-CLASS (W140)
			S-CLASS (W220)
			S-CLASS Coupe (
			SL (R129) (89-0
			SL (R230) (01-1
			SLK (R170) (96-
			VIANO (W639) (0
			VITO
		MG	MG TF (02-09)
			MG ZR (01-05)
			MG ZS (01-05)
			MG ZT (01-05)
		MITSUBISHI	COLT IV (92-96)
			COLT V (95-03)
			DELICA (07-)
			GALANT V (92-96
			L 200 (96-07)
			L 300 (86-)
			L 400
			LANCER V (91-03
			LANCER VI (95-0
			MAGNA (96-05)
			OUTLANDER II (0
			OUTLANDER III (
			PAJERO II (90-0
			PAJERO III (00-
			PAJERO Pinin (9
			PAJERO Sport I
			SAPPORO III (87
			SPACE RUNNER (9
			SPACE STAR (98-
			SPACE WAGON (98
		MITSUBUKA	GALUE (96-)
			RYOGA (99-)
			VIEWT (K11) (94

DENSO P/N	TT	MAKE	MODEL
IK16TT	-		YUGA (99-)
<i>continued</i>			ZERO I (95-01)
		NISSAN	100 NX (90-94)
			AD Wagon (99-04
			ALMERA I (95-00
			ALMERA II (00-)
			ALMERA TINO (00
			BLUEBIRD SYLPHY
			MAXIMA (88-94)
			MAXIMA QX (00-0
			MICRA II (92-03
			PICK UP (D22) (
			PRIMERA (90-98)
			PRIMERA (96-02)
			SERENA (92-01)
			SKYLINE (R33) (
			SKYLINE (R34) (
			SUNNY III (90-0
			VANETTE CARGO (
		OPEL	AGILA (00-07)
			ASTRA G (98-09)
			ASTRA H (04-)
			COMBO (01-)
			CORSA C (00-09)
			CORSA D (06-)
			FRONTERA B (98-
			INSIGNIA (08-)
			MERIVA A (03-10
			MOKKA (12-)
			MONTEREY B (98-
			SIGNUM (03-)
			TIGRA TwinTop (
			VECTRA C (02-)
			ZAFIRA A (99-05
			ZAFIRA B (05-)
			ZAFIRA C (11-)
		PERODUA	KENARI (00-)
		PEUGEOT	106 I (91-96)
			106 II (96-)
			205 II (87-98)
			206 (98-)
			306 (93-02)
			4007 (07-)
		PLYMOUTH	BREEZE (95-01)
		PUCH	G-MODELL (W463)
		RENAULT	TWINGO I (93-)
		ROVER	25 (99-05)
			45 (00-05)
			75 (99-05)
			400 (90-98)
			STREETWISE (03-
		SAAB	9-3 (02-)
		SEAT	ALHAMBRA (7V) (
			CORDOBA (6K2) (
			CORDOBA (6L) (0
			IBIZA III (6K2)
			IBIZA IV (6L) (
			INCA (6K9) (95-
			LEON (1M) (99-0
			TOLEDO II (1M)
		SKODA	FABIA (6Y) (99-
			FABIA (06-14)
			FELICIA Fun (97
			FELICIA II (6U)
			OCTAVIA (1U) (9
			ROOMSTER (5J) (
		SUBARU	FORESTER (97-02
			FORESTER (02-)
			IMPREZA (00-)
			LEGACY III (98-
			LEGACY IV (03-)

Spark & Glow Plugs

Buyers Guide

DENSO P/N	TT	MAKE	MODEL
IK16TT	-		OUTBACK (00-03)
<i>continued</i>			OUTBACK (03-09)
			VIVIO (92-98)
		SUZUKI	GRAND VITARA (0
			IGNIS I (00-03)
			WAGON R (03-05)
		TOYOTA	4 RUNNER (N10)
			ALLION I (01-07
			AURIS (06-)
			AVENSIS (97-03)
			AVENSIS (03-09)
			bB (00-05)
			CALDINA (92-97)
			CALDINA (97-01)
			CARINA E (92-97
			CELICA (99-05)
			CENTURY (97-)
			COROLLA (E9) (8
			COROLLA (E10) (
			COROLLA (E11) (
			COROLLA (E12) (
			COROLLA (E14, E
			COROLLA Verso (
			CORONA (87-92)
			CORSA (94-99)
			ECHO (99-05)
			HIACE IV (95-)
			HILUX II (83-05
			IST (04-07)
			LAND CRUISER (J
			LAND CRUISER
			LAND CRUISER
			MR 2 III (99-07
			PASEO (95-99)
			PLATZ (99-05)
			PORTE I (04-12)
			PREVIA I (90-00
			PRIUS (00-04)
			PRIUS (03-09)
			PROBOX
			RAUM (03-)
			RAV 4 II (00-05
			STARLET (P9) (9
			SUPRA (93-02)
			TERCEL (94-99)
			TUNDRA (99-06)
			URBAN CRUISER (
			VIOS
			WILL Cypha (01-
			WILL VS (01-04)
			WISH (03-09)
			YARIS (99-05)
			YARIS (05-)
			YARIS (10-)
			YARIS VERSO (99
		UAZ	HUNTER (04-)
			PATRIOT (04-)
		VAUXHALL	AGILA I (A) (00
			ASTRA IV (G) (9
			ASTRA V (H) (04
			COMBO II (C) (0
			CORSA II (C) (0
			CORSA III (D) (
			FRONTERA II (B)
			INSIGNIA (08-)
			MERIVA I (A) (0
			MOKKA (12-)
			MONTEREY II (98
			SIGNUM (02-08)
			TIGRA TwinTop (
			VECTRA II (C) (

DENSO P/N	TT	MAKE	MODEL
IK16TT	-		ZAFIRA II (B) (
<i>continued</i>			ZAFIRA III (C)
		VW	BORA (1J) (98-0
			CADDY II (9K, 9
			FOX (5Z) (03-)
			GOLF IV (1J, 1E
			JETTA III (1K2)
			LUPO (6X, 6E) (
			NEW BEETLE (9C,
			PASSAT (3B3, 3B
			POLO (6N2) (99-
			POLO (9N) (01-0
			POLO Saloon (9A
			SHARAN (7M) (95
			TRANSPORTER IV
			VENTO (1H2) (91
		ZASTAVA	10 (05-)
IK20	IK20TT	BENTLEY	CONTINENTAL (91
		BMW	3 (E36) (90-00)
		DAIHATSU	MIRA GINO (06-)
		FORD	FIESTA II (83-9
			GALAXY (95-06)
			SCORPIO II (94-
		HONDA	CIVIC VI (94-01
		JAGUAR	XJ (97-03)
		MAZDA	323 C IV (89-00
			323 S IV (89-94
			MX-5 I (90-98)
			MX-5 II (98-05)
		PEUGEOT	205 II (87-98)
IK20G	-	HONDA	LIFE (03-)
IK20L	IK20TT	DODGE	CALIBER (06-)
		OPEL	ASTRA G (98-09)
			ASTRA H (04-)
			ASTRA J (09-)
			CORSA D (06-)
			INSIGNIA (08-)
		SAAB	9-5 (10-)
		VAUXHALL	ASTRA VI (J) (0
			CORSA III (D) (
			INSIGNIA (08-)
IK20TT	-	ACURA	MDX (00-05)
			NSX (90-)
			NSX Targa (95-9
		ALFA ROMEO	33 (90-94)
			75 (85-92)
			145
			147 (00-10)
			155 (92-97)
			156 (97-06)
			159 (05-11)
			164 (87-98)
			166 (98-07)
			GT (03-10)
			GTV (95-05)
			SPIDER (94-05)
		ALPINA	B3 (E36) (93-99
			B3 (E46) (99-06
			B8 (E36) (95-98
			B10 (E39) (96-0
			B12 (E31) (90-9
			B12 (E38) (95-0
			ROADSTER (Z8) (
			ROADSTER S (Z4)
		AUDI	80 (8C, B4) (91
			100 (4A, C4) (9
			A2 (8Z) (00-05)
			A3 (8L) (96-03)
			A3 (8P) (03-13)
			A3 Convertible
			A4 (8D, B5) (94

DENSO P/N	TT	MAKE	MODEL
IK20TT	-		A4 (8E, B6) (00)
<i>continued</i>			A4 (8E, B7) (04)
			A4 (8K, B8) (07)
			A4 Convertible
			A5 (8T, 8F) (07)
			A6 (4A, C4) (94)
			A6 (4B, C5) (97)
			A6 (4F, C6) (04)
			A6 (4G, C7) (10)
			A7 (4GA) (10-)
			A8 (4D) (94-02)
			A8 (4E) (02-10)
			ALLROAD (4BH) (
			CABRIOLET (8G7)
			COUPE (89, 8B)
			Q5 (8R) (08-)
			TT (8N) (98-06)
		AUSTIN	MAESTRO (83-92)
			MONTEGO (84-92)
		AUTOBIANCHI	Y10 (85-95)
		BEDFORD	RASCAL (86-90)
		BENTLEY	ARNAGE (98-09)
			CONTINENTAL (91
			CONTINENTAL (03
			CONTINENTAL Fly
		BMW	1 (E81, E87) (0
			1 (E82, E88) (0
			3 (E30) (82-94)
			3 (E36) (90-00)
			3 (E46) (98-05)
			3 (E90, E91) (0
			3 (E92, E93) (0
			5 (E28) (81-87)
			5 (E34) (87-97)
			5 (E39) (95-04)
			5 (E60, E61) (0
			6 (E63, E64) (0
			7 (E32) (86-94)
			7 (E38) (94-01)
			7 (E65, E66) (0
			8 (E31) (90-99)
			X1 (E84) (09-)
			X3 (E83) (04-)
			X5 (E53) (00-)
			X5 (E70) (07-13
			Z3 (E36) (95-03
			Z4 (E85, E86) (
			Z8 (E52) (00-03
		BYD	F3 (05-)
			F3R (07-)
		CADILLAC	BLS (06-)
			CTS (02-07)
		CATERHAM	21 (94-)
			SUPER SEVEN (80
		CHERY	EASTAR CROSS (0
			QIYUN (03-10)
			QQ6 (06-)
			TIGGO 3 (07-)
			TIGGO (05-08)
			TIGGO (10-)
			X1 (10-)
		CHEVROLET	AVEO (T250, T25
			AVEO (T300) (11
			CAPTIVA (06-)
			CRUZE (00-08)
			CRUZE (09-)
			EPICA (05-)
			EVANDA (05-)
			KALOS (05-)
			LACETTI (05-)
			LANOS (05-)

DENSO P/N	TT	MAKE	MODEL
IK20TT	-		NUBIRA (05-)
<i>continued</i>			OPTRA (03-08)
			ORLANDO (11-)
			REZZO (05-)
			TRAX (12-)
		CHRYSLER	CIRRUS (94-00)
			CROSSFIRE (03-0
			NEON (94-99)
			NEON (99-)
			PT CRUISER (00-
			STRATUS (95-01)
			VOYAGER (95-01)
		CITROËN	AX (86-98)
			BERLINGO (B9) (
			BERLINGO (MF) (
			BX (82-94)
			C2 (03-)
			C3 I (02-)
			C3 II (09-)
			C3 Pluriel (03-
			C4 Aircross (12
			C15 (84-05)
			C-CROSSER (07-)
			EVASION (94-02)
			JUMPER (94-02)
			JUMPER (02-)
			NEMO (08-)
			SAXO (96-04)
			XANTIA (93-98)
			XANTIA (98-03)
			XM (89-94)
			XM (94-00)
			XSARA (97-05)
			ZX (91-98)
		DACIA	DUSTER (10-)
			LODGY (12-)
			LOGAN I (04-)
			LOGAN MCV I (07
			SANDERO I (08-)
			SOLENZA (03-)
			SUPERNOVA (00-0
		DAEWOO	CIELO (94-98)
			ESPERO (91-99)
			EVANDA (02-)
			GENTRA (02-05)
			GENTRA (05-)
			KALOS (02-)
			LACETTI (97-99)
			LACETTI (04-)
			LANOS (97-)
			LEGANZA (97-04)
			NEXIA (95-08)
			NEXIA (08-)
			NUBIRA (97-)
			NUBIRA (03-)
			TACUMA
		DAIHATSU	ALTIS (96-01)
			ALTIS (06-)
			APPLAUSE I (89-
			APPLAUSE II (97
			CHARADE III (87
			CHARADE IV (93-
			COPEN (03-)
			FEROZA (88-99)
			GRAN MOVE (96-)
			HIJET (92-)
			HIJET (98-)
			MIRA GINO (06-)
			MOVE (02-)
			SIRION (98-05)
			SIRION (05-)

DENSO P/N	TT	MAKE	MODEL
IK20TT	-		TERIOS (97-)
<i>continued</i>			TERIOS (05-)
			YRV (01-)
		DODGE	CALIBER (06-)
			CARAVAN (95-02)
			DURANGO (03-10)
			NEON (94-99)
			NEON (99-)
			NITRO (06-)
			RAM (01-08)
			STRATUS (95-01)
		DR	DR 1 (10-)
			DR 2 (10-)
			DR 5 (11-)
		FAW	V2 (13-)
		FIAT	BARCETTA (95-0
			BRAVA (95-02)
			BRAVO I (95-01)
			CINQUECENTO (91
			COUPE (93-00)
			DOBLO (01-)
			DUCATO (94-02)
			DUCATO (02-)
			FIORINO (07-)
			MAREA (96-07)
			MULTIPLA (99-10
			PALIO (96-)
			PANDA (80-04)
			PUNTO (93-00)
			PUNTO (99-)
			QUBO (08-)
			SEDICI (06-)
			SEICENTO (98-10
			STILO (01-08)
			STRADA (99-)
			ULYSSE (94-02)
			UNO (83-00)
		FORD	ESCORT II (73-8
			ESCORT IV (85-9
			ESCORT VI (92-9
			ESCORT VII (95-
			FIESTA II (83-9
			FIESTA III (89-
			GALAXY (95-06)
			ORION II (85-90
			ORION III (90-9
			SCORPIO I (85-9
			SCORPIO II (94-
			TRANSIT (94-00)
			TRANSIT (00-06)
			TRANSIT TOURNEO
		FORD USA	PROBE II (93-98
		FSO	LANOS (04-08)
			POLONEZ III (92
		GEELY	CK (05-)
		GREAT WALL	HOVER H5 (10-)
		HOLDEN	APOLLO (JM) (93
			ASTRA G (TS) (9
			ASTRA H (AH) (0
			NOVA (91-94)
			NOVA (94-97)
		HONDA	ACCORD IV (90-9
			ACCORD V (93-98
			ACCORD VI (97-0
			ACCORD VII (03-
			ACCORD VIII (08
			CITY (99-04)
			CITY (03-)
			CIVIC IV (87-95
			CIVIC IX (12-)
			CIVIC V (91-97)

DENSO P/N	TT	MAKE	MODEL
IK20TT	-		CIVIC VI (94-01
<i>continued</i>			CIVIC VII (00-0
			CIVIC VIII Hatc
			CIVIC VIII Salo
			CR-V I (95-02)
			CR-V II (01-06)
			CR-V III (06-)
			CRX II (87-92)
			CRX III (92-98)
			ELEMENT (02-11)
			ELYSION (04-)
			FR-V (04-)
			INSPIRE (98-03)
			JAZZ II (02-08)
			JAZZ III (08-)
			JAZZ Saloon (03
			LAGREAT (98-02)
			LEGEND II (91-9
			LEGEND III (96-
			LEGEND IV (06-)
			NSX (90-05)
			ODYSSEY (02-)
			PILOT (05-08)
			PRELUDE IV (92-
			PRELUDE V (96-0
			RIDGELINE (05-)
			SHUTTLE (94-04)
			STREAM (01-)
		HYUNDAI	ACCENT I (94-00
			ACCENT II (99-0
			ACCENT III (05-
			LANTRA II (95-0
			S COUPE (90-96)
		INFINITI	G20 (90-97)
		INNOCENTI	ELBA (91-96)
		ISUZU	GEMINI (88-90)
			TROOPER (91-98)
		JAGUAR	XJ (86-94)
			XJ (94-97)
			XJ (97-03)
			XJ Coupe (73-96
			XK 8 (96-05)
		JEEP	CHEROKEE
			CHEROKEE (84-01
			CHEROKEE (01-08
			COMMANDER (05-1
			GRAND CHEROKEE
			GRAND CHEROKEE
			GRAND CHEROKEE
		KIA	CARENS I (00-02
			CARENS II (02-)
			CARNIVAL I (99-
			CARNIVAL II (99
			CLARUS (96-)
			RIO I (00-05)
			SHUMA I (96-01)
			SHUMA II (01-04
			SPORTAGE I (94-
		LADA	110 (95-)
			LARGUS (12-)
		LANCIA	DEDRA (89-99)
			DELTA II (93-99
			KAPPA (94-01)
			LYBRA (99-05)
			THESIS (02-09)
			Y (95-03)
			ZETA (95-02)
		LAND ROVER	DISCOVERY I (89
			DISCOVERY IV (0
			FREELANDER I (9
			RANGE ROVER III

DENSO P/N	TT	MAKE	MODEL
IK20TT	-	LEXUS	GS (93-97)
<i>continued</i>			GS (97-05)
			GS (05-11)
			GX (01-09)
			IS I (99-05)
			LS (89-94)
			LS (94-00)
			LS (00-06)
			LX (98-08)
			RX (00-03)
			RX (03-08)
			SC (01-10)
		LOTUS	2 ELEVEN (07-11)
			ELAN (89-95)
			ELISE 340R (00-
			ELISE (95-01)
			ELISE (00-)
			ESPRIT S4 (89-0
			EUROPA S (06-)
			EXIGE (00-12)
		MAYBACH	MAYBACH (02-12)
		MAZDA	323 C IV (89-00)
			323 F IV (87-94)
			323 F V (94-98)
			323 F VI (98-04)
			323 P V (96-)
			323 S IV (89-94)
			323 S V (94-98)
			323 S VI (98-04)
			626 II (82-87)
			626 III (87-97)
			626 IV (91-97)
			929 II (82-87)
			929 III (87-91)
			E-SERIE (SR) (8
			MX-5 I (90-98)
			MX-5 II (98-05)
			XEDOS 6 (92-99)
			XEDOS 9 (93-02)
		MERCEDES-BENZ	A-CLASS (W168)
			A-CLASS (W169)
			B-CLASS (W245)
			C-CLASS (202) (
			C-CLASS (203) (
			C-CLASS Coupe (
			CLK (208) (97-0
			CLK (209) (02-1
			E-CLASS (210) (
			M-CLASS (W163)
			S-CLASS (W140)
			S-CLASS (W220)
			S-CLASS Coupe (
			SLK (R170) (96-
			SLK (R171) (04-
			SPRINTER 2-t (9
			SPRINTER 3-t (9
			SPRINTER 4-t (9
			VANEO (414) (02
			V-CLASS (638
			VITO (638) (96-
		MG	MG 6 (10-)
			MG TF (02-09)
			MG X-POWER (03-
			MG ZR (01-05)
			MG ZS (01-05)
			MG ZT (01-05)
			MGF (95-02)
		MINI	MINI (R50, R53)
			MINI Convertibl
		MITSUBISHI	3000 GT (92-99)
			ASX (10-)

DENSO P/N	TT	MAKE	MODEL
IK20TT	-		CARISMA (95-06)
<i>continued</i>			COLT IV (92-96)
			COLT V (95-03)
			eK (00-)
			GALANT V (92-96)
			GALANT VI (96-0
			LANCER (07-)
			LANCER III (83-
			LANCER IV (88-9
			LANCER V (91-03
			LANCER VI (95-0
			LANCER VII (03-
			OUTLANDER II (0
			OUTLANDER III (
			PAJERO I (82-91
			PAJERO IV (06-)
			SIGMA (90-96)
			SPACE RUNNER (9
			SPACE STAR (98-
			SPACE WAGON (91
			SPACE WAGON (98
			TOPPO (90-03)
			TOPPO (08-)
		MITSUOKA	LA SEYDE (00-04
			NOUERA (02-)
			OROCHI (06-)
		MORGAN	AERO 8 (00-)
			AERO (12-)
			AERO Supersport
			PLUS EIGHT (68-
		NISSAN	180 SX (88-94)
			200 SX (93-99)
			ALMERA I (95-00
			ALMERA II (00-)
			ALMERA TINO (00
			CLIPPER Van (03
			MAXIMA QX (95-0
			MAXIMA QX (00-0
			PRIMASTAR (01-)
			PRIMERA (90-98)
			PRIMERA (96-02)
			SERENA (92-01)
			SUNNY III (90-0
			TERRANO I (87-9
		OPEL	ADAM (12-)
			AGILA (00-07)
			ANTARA (06-)
			ASCONA C (81-88
			ASTRA F (91-01)
			ASTRA F CLASSIC
			ASTRA G (98-09)
			ASTRA H (04-)
			ASTRA J (09-)
			CALIBRA (90-97)
			COMBO (94-01)
			COMBO (01-)
			CORSA A (82-93)
			CORSA B (93-00)
			CORSA C (00-09)
			CORSA D (06-)
			FRONTERA A (92-
			INSIGNIA (08-)
			KADETT E (84-94
			MERIVA A (03-10
			MERIVA B (10-)
			MOKKA (12-)
			OMEGA A (86-94)
			OMEGA B (94-03)
			SENATOR B (87-9
			SIGNUM (03-)
			SINTRA (96-99)

DENSO P/N	TT	MAKE	MODEL
IK20TT	-		SPEEDSTER (00-)
<i>continued</i>			TIGRA (94-00)
			VECTRA A (88-95)
			VECTRA B (95-03)
			VECTRA C (02-)
			VIVARO A (01-)
			ZAFIRA A (99-05)
			ZAFIRA B (05-)
			ZAFIRA C (11-)
		PANTHER	KALLISTA (82-93)
		PERODUA	MYVI (06-11)
		PEUGEOT	106 I (91-96)
			106 II (96-)
			205 I (83-94)
			205 II (87-98)
			206 (98-)
			206+ (09-)
			207 (06-)
			306 (93-02)
			307 (00-)
			309 I (85-89)
			309 II (89-93)
			405 I (87-93)
			405 II (92-99)
			406 (95-04)
			604 (77-87)
			605 (89-99)
			806 (94-02)
			1007 (05-)
			4007 (07-)
			4008 (12-)
			BIPPER (08-)
			BOXER (94-02)
			BOXER (02-)
			PARTNER
		PIAGGIO	PORTER (93-)
		PLYMOUTH	BREEZE (95-01)
			NEON (94-)
		PORSCHE	911 (996) (97-0
			BOXSTER (986) (
			CAYENNE (955) (
		PROTON	AEROBACK (88-96
			IMPIAN (01-)
			PERSONA 300 (96
			PERSONA 400 (94
			WIRA (00-)
		RENAULT	19 I (88-92)
			19 II (92-01)
			21 (86-95)
			25 (84-93)
			AVANTIME (01-03
			CLIO I (90-98)
			CLIO II (98-)
			CLIO III (05-)
			DUSTER (09-)
			ESPACE III (96-
			ESPACE IV (02-)
			FLUENCE (10-)
			GRAND SCÉNIC II
			GRAND SCÉNIC II
			KANGOO (97-)
			KANGOO (08-)
			LAGUNA I (93-01
			LAGUNA II (01-)
			LAGUNA III (07-
			LOGAN I (04-)
			MEGANE I (96-03
			MEGANE II (02-)
			MEGANE III (08-
			MEGANE Scénic (
			MODUS (04-)

DENSO P/N	TT	MAKE	MODEL
IK20TT	-		RAPID (85-98)
<i>continued</i>			SAFRANE I (92-9
			SAFRANE II (96-
			SANDERO (Stepwa
			SCÉNIC I (99-03
			SCÉNIC II (03-)
			SCÉNIC III (09-
			SPORT Spider (9
			THALIA I (98-)
			THALIA II (08-)
			TRAFIC II (01-)
			TWINGO II (07-)
			VEL SATIS (02-)
			WIND (10-)
		ROLLS-ROYCE	PHANTOM (02-)
		ROVER	25 (99-05)
			45 (00-05)
			75 (99-05)
			100
			200 (RF) (95-00
			200 (XH) (85-89
			200 (XW) (89-99
			400 (90-98)
			400 (95-00)
			600 (93-99)
			800 (86-99)
			CABRIOLET (90-9
			COUPE (96-99)
			MAESTRO (90-95)
			STREETWISE (03-
		SAAB	9-3 (02-)
			9-3X (09-)
			9-5 (10-)
			900 II (93-98)
			9000 (84-98)
		SEAT	ALHAMBRA (7V) (
			ALTEA (XL) (5P)
			AROSA (6H) (97-
			CORDOBA (6K1) (
			CORDOBA (6K2) (
			CORDOBA (6L) (0
			EXEO (3R) (08-)
			IBIZA II (6K1)
			IBIZA III (6K2)
			IBIZA IV (6L) (
			IBIZA V (6J) (0
			INCA (6K9) (95-
			LEON (1M) (99-0
			LEON (1P) (05-)
			TOLEDO I (1L) (
			TOLEDO II (1M)
			TOLEDO III (5P)
		SKODA	FABIA (6Y) (99-
			FABIA (06-14)
			FAVORIT (78) (8
			FELICIA I (6U)
			OCTAVIA (1U) (9
			OCTAVIA (1Z) (0
			RAPID (HN) (12-
			ROOMSTER (5J) (
			SUPERB (3U) (01
		SMART	CABRIO (450) (0
			CITY-Coupe (450
			CROSSBLADE (450
		SPYKER	C12 (07-)
		SUBARU	FORESTER (97-02
			FORESTER (02-)
			IMPREZA (92-00)
			IMPREZA (00-)
			JUSTY II (95-03
			JUSTY III (03-)

DENSO P/N	TT	MAKE	MODEL
IK20TT	-		LEGACY I (89-94)
<i>continued</i>			LEGACY II (94-9)
			LEGACY IV (03-)
			LEGACY OUTBACK
			LEGACY V (09-)
			OUTBACK (03-09)
			OUTBACK (09-)
			REX III (89-92)
			SVX (92-97)
			VIVIO (92-98)
		SUZUKI	ALTO III (93-02)
			BALENO (95-02)
			CARRY (99-)
			GRAND VITARA (9
			GRAND VITARA (0
			IGNIS I (00-03)
			IGNIS II (03-)
			JIMNY (98-)
			LIANA (01-)
			SWIFT II (89-05
			SWIFT III (05-)
			SX4 (06-)
			VITARA (88-99)
			WAGON R (03-05)
			WAGON R+ (00-)
			X-90 (95-97)
		TATA	INDICA (98-)
		TOYOTA	ALPHARD I (03-0
			ALPHARD II (08-
			ALTEZZA (99-05)
			AURIS (06-)
			AVALON (95-05)
			AVALON (99-05)
			AVENSIS (97-03)
			AVENSIS (03-09)
			AVENSIS Verso (
			CAMI (99-05)
			CAMRY (83-88)
			CAMRY (90-97)
			CAMRY (96-01)
			CAMRY (01-06)
			CAMRY (06-11)
			CAMRY (11-)
			CAMRY SOLARA (9
			CAMRY SOLARA (0
			CAMRY SOLARA (0
			CAMRY SOLARA (0
			CARINA E (92-97
			CELICA (89-93)
			CELICA (93-99)
			CELICA (99-05)
			CHASER (96-01)
			COROLLA (E10) (
			COROLLA (E11) (
			COROLLA (E12) (
			CRESSIDA (92-96
			CROWN (08-12)
			CURREN (89-94)
			CURREN (93-98)
			HARRIER (98-03)
			HARRIER (03-)
			KLUGER
			LAND CRUISER (J
			LAND CRUISER (J
			LAND CRUISER
			MAJESTA (99-03)
			MARK II (80-01)
			MR 2 II (89-00)
			PICNIC (96-01)
			PREVIA II (00-0
			RAV 4 I

DENSO P/N	TT	MAKE	MODEL
IK20TT	-		RAV 4 II (00-05
<i>continued</i>			RAV 4 III (05-)
			SCEPTER (92-96)
			SEQUOIA (00-)
			SIENNA (97-03)
			SIENNA (03-09)
			SOARER (90-00)
			SUPRA (93-02)
			VISTA (90-98)
			VISTA (98-03)
			WINDOM (96-01)
			WINDOM (01-06)
			YARIS (99-05)
		TOYOTA (FAW)	LAND CRUISER (0
		TRIUMPH	ACCLAIM (82-85)
		TVR	CERBERA (96-03)
		VAUXHALL	ADAM (12-)
			AGILA I (A) (00
			ANTARA (06-)
			ASTRA II (84-94
			ASTRA III (F) (
			ASTRA IV (G) (9
			ASTRA V (H) (04
			ASTRA VI (J) (0
			CALIBRA (90-97)
			CARLTON III (86
			CAVALIER III (8
			COMBO I (B) (94
			COMBO II (C) (0
			CORSA I (B) (93
			CORSA II (C) (0
			CORSA III (D) (
			FRONTERA I (A)
			INSIGNIA (08-)
			MERIVA I (A) (0
			MERIVA II (B) (
			MONTEREY I (91-
			OMEGA (B) (94-0
			SENATOR II (B)
			SIGNUM (02-08)
			SINTRA (96-99)
			SPEEDSTER (VX22
			TIGRA (94-00)
			VECTRA I (B) (9
			VECTRA II (C) (
			VIVARO (A) (01-
			ZAFIRA I (A) (9
			ZAFIRA II (B) (
			ZAFIRA III (C)
		VOLVO	850 (91-97)
			960 I (90-94)
			960 II (94-96)
			C70 I (97-05)
			S40 I (95-03)
			S60 I (00-10)
			S70 (96-00)
			S80 I (98-06)
			S80 II (06-)
			S90 (96-98)
			V40 (95-04)
			V70 I (96-00)
			V70 II (00-07)
			V90 (96-98)
			XC70 I Cross Co
			XC90 I (02-)
		VW	BORA (1J) (98-0
			CADDY II (9K, 9
			CADDY III (2K,
			CORRADO (53) (
			EOS (1F) (06-)
			FOX (5Z) (03-)

Spark & Glow Plugs

Buyers Guide

DENSO P/N	TT	MAKE	MODEL
IK20TT	-		GOLF III (1H, 1
<i>continued</i>			GOLF IV (1J, 1E
			GOLF PLUS (5M,
			GOLF V (1K) (03
			GOLF VI (5K, 51
			JETTA III (1K2)
			JETTA IV (162)
			LUPO (6X, 6E) (
			MULTIVAN V (7H,
			NEW BEETLE (9C,
			PASSAT (3A2, 35
			PASSAT (3B2, 3B
			PASSAT (3B3, 3B
			PASSAT (3C) (05
			PHAETON (3D) (0
			POLO (6N1) (94-
			POLO (6N2) (99-
			POLO (6R, 6C) (
			POLO (9N) (01-0
			POLO Classic (6
			POLO Saloon (9A
			POLO Variant (6
			SHARAN (7M) (95
			TOUAREG (7L) (0
			TOURAN (1T1, 1T
			TRANSPORTER IV
			TRANSPORTER V (
			VENTO (1H2) (91
		WIESMANN	GT MF4 (03-)
			MF3 Roadster (9
			MF4 Roadster (0
		ZAZ	LANOS (04-)
IK22	-	AUDI	80 (8C, B4) (91
			A4 (8E, B7) (04
			A4 Convertible
			A6 (4F, C6) (04
			A6 Allroad (4FH
			A8 (4E) (02-10)
			COUPE (89, 8B)
		CATERHAM	SUPER SEVEN (80
		MINI	MINI (R50, R53)
			MINI Convertibl
		PEUGEOT	106 I (91-96)
			205 I (83-94)
		PORSCHE	911 (996) (97-0
			911 (997) (04-1
			BOXSTER (987) (
			CAYMAN (987) (0
		SPYKER	C8 (00-)
			C8 Aileron (10-
		TOYOTA	SUPRA (93-02)
		VOLVO	V70 I (96-00)
		VW	PASSAT (3A2, 35
IK24	-	AUDI	A4 (8K, B8) (07
			A5 (8T, 8F) (07
			A6 (4F, C6) (04
			A6 (4G, C7) (10
			A7 (4GA) (10-)
			A8 (4H) (09-)
		LAND ROVER	DISCOVERY IV (0
		PORSCHE	CARRERA GT (03-
		VW	TOUAREG (7P) (1
IK27	-	LAMBORGHINI	GALLARDO (03-)
IKBH20TT	-	LEXUS	GS (05-11)
			GS (12-)
			IS C (09-)
			IS II (05-)
			IS III (13-)
			LS (06-)
		TOYOTA	AURION (00-11)
			CROWN (03-08)

DENSO P/N	TT	MAKE	MODEL
IKBH20TT	-		CROWN (08-12)
<i>continued</i>			CROWN (12-)
			MARK X I (04-09
			MARK X II (09-)
IKH16	IKH16TT	NISSAN	CUBE (03-05)
			MICRA C+C (05-)
			MICRA III (03-1
			MICRA IV (10-)
			NOTE (06-)
			NOTE (13-)
		PEUGEOT	406 (95-04)
		RENAULT	AVANTIME (01-03
IKH16TT	-	CITROËN	BERLINGO (B9) (
			BERLINGO (MF) (
			C1 I (05-)
			C2 (03-)
			C3 I (02-)
			C3 Pluriel (03-
			C4 (Grand) Pica
			C4 Aircross (12
			C4 Coupe (04-)
			C4 I (LC) (04-)
			C4 II (B7) (09-
			C5 I (01-04)
			C5 II (04-)
			C5 III (08-)
			C6 (05-)
			C8 (02-)
			C-ELYSEE (12-)
			EVASION (94-02)
			JUMPY (95-)
			XSARA (97-05)
			XSARA Picasso (
		DODGE	CHARGER (11-)
		FIAT	SCUDO (96-06)
			ULYSSE (94-02)
		HYUNDAI	EQUUS
			GRANDEUR (05-)
			GRANDEUR (11-)
			ix35 (09-)
			SANTA FÉ I (00-
			SANTA FÉ II (06
			SONATA V (05-)
			SONATA VI (09-)
		INFINITI	FX (03-)
			G (02-)
			M35 (05-)
			M45 (05-)
			Q45 III (01-)
		KIA	MAGENTIS (05-)
			OPTIMA (11-)
			SORENTO II (09-
			SPORTAGE III (1
		LANCIA	PHEDRA (02-10)
		LEXUS	ES (12-)
			GX (09-)
			RX (08-)
		MITSUBISHI	ASX (10-)
			COLT VI (04-)
			LANCER (07-)
		MITSUOKA	GALUE (96-)
			VIEWT (K12) (05
		NISSAN	350 Z (02-)
			ALMERA II (00-)
			ALMERA TINO (00
			ALTIMA (01-06)
			CUBE (03-05)
			JUKE (10-)
			MICRA C+C (05-)
			MICRA III (03-1
			MICRA IV (10-)

DENSO P/N	TT	MAKE	MODEL			
IKH16TT <i>continued</i>	-		MURANO (07-)			
			NOTE (06-)			
			NOTE (13-)			
			PATHFINDER (97-)			
			PRIMERA (96-02)			
			PRIMERA (02-)			
			QUEST (03-)			
			SKYLINE (V35) (
			TEANA (03-08)			
			TITAN (03-)			
X-TRAIL (01-)						
X-TRAIL (07-)						
PEUGEOT			107 (05-)			
			206 (98-)			
			206 CC (00-)			
			206+ (09-)			
			207 (06-)			
			307 (00-)			
			406 (95-04)			
			407 (04-)			
			607 (00-)			
			806 (94-02)			
			807 (02-)			
			1007 (05-)			
			EXPERT (96-)			
			EXPERT (07-)			
			PARTNER			
			PARTNER			
			RENAULT			AVANTIME (01-03
						ESPACE IV (02-)
						LAGUNA II (01-)
						MEGANE I (96-03
VEL SATIS (02-)						
SUZUKI			GRAND VITARA (0			
			SX4 (06-)			
TOYOTA			ALLION II (07-)			
			AURIS (06-)			
			AURIS (12-)			
			AYGO (05-)			
			CAMRY (06-11)			
			CAMRY (11-)			
			COROLLA (E14, E			
			COROLLA (E16) (
			COROLLA Rumion			
			COROLLA Verso (
			IQ (09-)			
			KLUGER			
			PORTE II (12-)			
			PREMIO (07-)			
			RACTIS (05-10)			
			RAV 4 IV (12-)			
			SPADE (12-)			
			VENZA (08-)			
			VERSO S (10-)			
			VIOS			
YARIS (05-)						
YARIS (10-)						
ZELAS (11-)						
IKH20	IKH20TT	BYD	M6 (10-)			
		CADILLAC	BLS (06-)			
			CTS (02-07)			
		FORD	KUGA I (08-)			
			S-MAX (06-)			
		LTI	TX (97-)			
		MITSUBISHI	COLT VI (04-)			
			ECLIPSE IV (05-			
			GALANT VII (03-			
			GRANDIS (04-)			
LANCER (07-)						
LANCER VII (03-						
OUTLANDER I (03						

DENSO P/N	TT	MAKE	MODEL		
IKH20 <i>continued</i>	IKH20TT		SAVRIN (01-)		
			OPEL	SIGNUM (03-)	
				VECTRA C (02-)	
			RENAULT	CLIO II (98-)	
				LAGUNA II (01-)	
			SAAB	9-3 (02-)	
			SMART	FORFOUR (454) (
			SUBARU	IMPREZA (00-)	
				VAUXHALL	SIGNUM (02-08)
					VECTRA II (C) (
IKH20TT	-	BMW	1 (E81, E87) (0		
			1 (E82, E88) (0		
			3 (E90, E91) (0		
			3 (E92, E93) (0		
			5 (E60, E61) (0		
			6 (E63, E64) (0		
			7 (E65, E66) (0		
			7 (F01, F02, F0		
			X1 (E84) (09-)		
			X3 (E83) (04-)		
			X5 (E70) (07-13		
			Z4 (E85, E86) (
			Z4 (E89) (09-)		
		BYD	M6 (10-)		
		CADILLAC	BLS (06-)		
			CTS (02-07)		
		CITROËN	C4 (Grand) Pica		
			C4 I (LC) (04-)		
			C5 I (01-04)		
			C5 II (04-)		
			C5 III (08-)		
			C8 (02-)		
			JUMPY (95-)		
			JUMPY (07-)		
		XSARA Picasso (
		DAIHATSU	BOON (06-)		
			CUORE VIII (07-		
			SIRION (05-)		
		FIAT	ULYSSE (02-11)		
		FORD	KUGA I (08-)		
			S-MAX (06-)		
		HONDA	CIVIC VIII Salo		
			INSIGHT (00-06)		
			INSIGHT (09-)		
			JAZZ III (08-)		
		HYUNDAI	GENESIS (08-)		
		LANCIA	PHEDRA (02-10)		
			ZETA (95-02)		
		LEXUS	ES (06-12)		
			ES (12-)		
GS (05-11)					
IS C (09-)					
LS (06-)					
LX (07-)					
RX (03-08)					
RX (08-)					
LOTUS	EVORA (09-)				
	EXIGE (12-)				
LTI	TX (97-)				
MERCEDES-BENZ	C-CLASS (203) (
	C-CLASS Coupe (
	CLC (CL203) (08				
	CLK (209) (02-1				
	CLS (C219) (04-				
	E-CLASS (211) (
	S-CLASS Coupe (
	SL (R230) (01-1				
	SLR (R199) (04-				
	COLT CZC (06-09				
	COLT VI (04-)				
	ECLIPSE IV (05-				

Spark & Glow Plugs

Buyers Guide

DENSO P/N	TT	MAKE	MODEL
IKH20TT	-		GALANT VII (03-
<i>continued</i>			GRANDIS (04-)
			LANCER (07-)
			LANCER VII (03-
			OUTLANDER I (03
			SAVRIN (01-)
		NISSAN	350 Z (02-)
			ALMERA II (00-)
			MURANO (03-)
			PATHFINDER (05-
			PATROL GR II (9
			PRIMERA (02-)
			TEANA (03-08)
			X-TRAIL (01-)
		OPEL	SIGNUM (03-)
			VECTRA C (02-)
		PEUGEOT	206 (98-)
			207 (06-)
			307 (00-)
			308 I (07-)
		RENAULT	CLIO II (98-)
			LAGUNA II (01-)
		SAAB	9-3 (02-)
		SMART	FORFOUR (454) (
		SUBARU	FORESTER (02-)
			FORESTER (08-)
			IMPREZA (00-)
			IMPREZA (08-)
			JUSTY IV (07-)
			LEGACY IV (03-)
			LEGACY V (09-)
			OUTBACK (00-03)
			OUTBACK (03-09)
			OUTBACK (09-)
			TRIBECA (05-)
		SUZUKI	GRAND VITARA (0
			KIZASHI (10-)
			SWIFT IV (10-)
			SX4 S-Cross (13
		TOYOTA	4 RUNNER (N18)
			ALPHARD II (08-
			AURION (00-11)
			AURION (11-)
			AURIS (06-)
			AVALON (05-)
			CAMRY (01-06)
			CAMRY (06-11)
			CAMRY (11-)
			CROWN (03-08)
			CROWN (08-12)
			DYNA (01-)
			FJ CRUISER (07-
			HARRIER (03-)
			HIACE V (05-)
			KLUGER
			LAND CRUISER (J
			LAND CRUISER
			LAND CRUISER
			MARK X I (04-09
			MARK X ZiO (07-
			PREVIA II (00-0
			PREVIA III (05-
			RAV 4 III (05-)
			SEQUOIA (00-)
			SIENNA (10-)
			TUNDRA (99-06)
			TUNDRA (07-)
			VENZA (08-)
		TOYOTA (GAC)	HIGHLANDER (09-
		VAUXHALL	SIGNUM (02-08)
			VECTRA II (C) (

DENSO P/N	TT	MAKE	MODEL
IKH20TT	-	VOLVO	C30 (06-12)
<i>continued</i>			C70 II (06-)
			S40 II (04-)
			S60 II (10-)
			S80 II (06-)
			V50 (04-)
			V60 (10-)
			V70 III (07-)
			XC60 (08-)
			XC70 II (07-)
			XC90 I (02-)
IKH22	-	FORD	FOCUS II (04-)
			MONDEO IV (07-)
		VOLVO	S80 II (06-)
			V50 (04-)
			V70 III (07-)
			XC60 (08-)
			XC90 I (02-)
IKH24	-	FORD	FOCUS II (04-)
IQ16	IQ16TT	SAAB	9-3 (98-03)
			900 I (78-94)
			900 II (93-98)
		TOYOTA	CARINA II (83-9
IQ16TT	-	CHEVROLET	MATIZ (05-)
		CITROËN	AX (86-98)
			BX (82-94)
		DAEWOO	KORANDO (99-)
			MUSSO (99-)
			REXTON (02-)
		JEEP	CJ5 - CJ8 (66-8
		MITSUOKA	GALUE (96-)
		NISSAN	300 ZX (84-90)
			BLUEBIRD (85-92
			PRIMERA (90-98)
			SUNNY II (86-91
			SUNNY III (90-0
		PEUGEOT	106 I (91-96)
			205 I (83-94)
			205 II (87-98)
			306 (93-02)
			405 II (92-99)
		RENAULT	19 II (92-01)
			CLIO I (90-98)
			MEGANE I (96-03
			MEGANE Scénic (
			RAPID (85-98)
		SAAB	9-3 (98-03)
			900 I (78-94)
			900 II (93-98)
		SKODA	FAVORIT (78) (8
			FELICIA Fun (97
			FELICIA I (6U)
		SSANGYONG	ACTYON I (05-)
			CHAIRMAN (97-)
			ISTANA (92-)
			KORANDO (96-)
			KYRON (05-)
			MUSSO (93-)
			REXTON (02-)
			RODIUS I (05-)
			STAVIC (05-)
		TOYOTA	CAMRY (86-91)
			CARINA E (92-97
			CARINA II (83-9
			CELICA (77-85)
			CELICA (85-89)
			CELICA (89-93)
			COROLLA (E8) (8
			COROLLA (E9) (8
			COROLLA (E10) (
			COROLLA FX (84-

DENSO P/N	TT	MAKE	MODEL
IQ16TT	-		MR 2 I (84-90)
<i>continued</i>			PICNIC (96-01)
			SUPRA (86-93)
IQ20	IQ20TT	MERCEDES-BENZ	E-CLASS (124) (
			E-CLASS Coupe
		SAAB	9-3 (98-03)
			900 II (93-98)
IQ20TT	-	ASTON MARTIN	VIRAGE (87-92)
			VIRAGE (90-00)
		AUSTIN	1000-Series (70
		CHERY	A1 (06-)
		CITROËN	AX (86-98)
			BX (82-94)
			C15 (84-05)
			EVASION (94-02)
			JUMPER (94-02)
			JUMPY (95-)
			XM (89-94)
			ZX (91-98)
		DAEWOO	MUSSO (99-)
		FIAT	DUCATO (94-02)
			PANDA (80-04)
			PUNTO (93-00)
			TIPO (87-95)
			UNO (83-00)
		FORD	ESCORT III (80-
			ESCORT IV (85-9
			ESCORT V (90-94
			ESCORT VI (92-9
			ESCORT VII (95-
			FIESTA II (83-9
			FIESTA III (89-
			ORION I (83-86)
			ORION II (85-90
			ORION III (90-9
			SCORPIO I (85-9
			SCORPIO II (94-
			SIERRA (87-93)
			TRANSIT (91-94)
		FORD AUSTRALIA	LASER (81-02)
			TELSTAR (83-96)
		FORD USA	PROBE II (93-98
		HONDA	ACCORD III (85-
			CIVIC IV (87-95
			CIVIC V (91-97)
			CIVIC VI (94-01
			CONCERTO (89-96
			CRX I (83-87)
			CRX II (87-92)
			INTEGRA (85-93)
			LEGEND I (86-90
			PRELUDE III (86
		JAGUAR	XJ (86-94)
			XJ (94-97)
			XJ Coupe (73-96
		LADA	110 (95-)
			111 (95-)
			112 (95-)
			GRANTA (11-)
			KALINA (04-)
			OKA (88-)
			PRIORA (2170, 2
		LANCIA	Y (95-03)
			Y10 (85-95)
		LEXUS	ES (89-97)
		MAZDA	323 III (85-95)
			626 II (82-87)
			626 III (87-97)
			929 III (87-91)
		MERCEDES-BENZ	CABRIOLET (A124
			C-CLASS (202) (

DENSO P/N	TT	MAKE	MODEL
IQ20TT	-		COUPE (C124) (8
<i>continued</i>			E-CLASS (124) (
			E-CLASS (210) (
			E-CLASS Coupe
			G-CLASS (W463)
			KOMBI (S124) (8
			Saloon (W124) (
			S-CLASS (W140)
			S-CLASS Coupe (
			SL (R129) (89-0
		MORGAN	FOUR FOUR (68-)
			PLUS FOUR (85-)
		MORRIS	ITAL (80-84)
		NISSAN	200 SX (88-94)
			300 ZX (84-90)
			BLUEBIRD (83-90
			BLUEBIRD (85-92
			CEDRIC (83-87)
			PATHFINDER (97-
			PRAIRIE (83-88)
			PRAIRIE Pro (88
			SILVIA (84-88)
			SKYLINE (R32) (
			SKYLINE (R33) (
			SKYLINE (R34) (
			STANZA (81-85)
			SUNNY II (86-91
		OPEL	MONTEREY A (91-
			VECTRA A (88-95
		PEUGEOT	205 I (83-94)
			205 II (87-98)
			305 II (82-90)
			306 (93-02)
			309 I (85-89)
			309 II (89-93)
			405 I (87-93)
			405 II (92-99)
			504 (68-89)
			505 (79-95)
			605 (89-99)
			BOXER (94-02)
			J5 (81-90)
			J5 (90-94)
			PARTNER
		PONTIAC	TRANS SPORT (89
		RELIANT	SCIMITAR (68-90
		RENAULT	19 I (88-92)
			19 II (92-01)
		ROVER	400 (95-00)
		SAAB	9-3 (98-03)
			9-5 (97-)
			900 I (78-94)
			900 II (93-98)
			9000 (84-98)
		SKODA	FAVORIT (78) (8
		SSANGYONG	KORANDO (96-)
			MUSSO (93-)
		TOYOTA	CAMRY (86-91)
			CAMRY (90-97)
			CARINA E (92-97
			CARINA II (83-9
			CELICA (77-85)
			CELICA (85-89)
			COROLLA (E9) (8
			COROLLA (E10) (
			MR 2 I (84-90)
			SUPRA (86-93)
		VOLVO	960 I (90-94)
			960 II (94-96)
		WESTFIELD	130 (97-)
IQ22	-	CITROËN	BX (82-94)

DENSO P/N	TT	MAKE	MODEL
IQ22	-	SAAB	900 I (78-94)
<i>continued</i>			
IQ24	-	ASTON MARTIN	VIRAGE (90-00)
		FORD	ESCORT III (80- FIESTA III (89- SIERRA (87-93)
IQ27	-	FORD	SIERRA (87-93)
IRL01-27	-	MAZDA	RX 8 (03-12)
IRT01-31	-	MAZDA	RX 8 (03-12)
IT16	IT16TT	CADILLAC	CTS (02-07)
		HUMMER	HUMMER H3 (05-)
		SAAB	9-7X (05-)
IT16TT	-	ASTON MARTIN	DB7 (94-03)
		BUICK	LE SABRE (85-91 LE SABRE (91-95 PARK AVENUE (90 SKYLARK (94-99)
		CADILLAC	ALLANTE (88-93) CTS (02-07) DEVILLE (90-93) DEVILLE (93-99) DEVILLE (99-04) DTS (05-) ELDORADO (87-91 ELDORADO (91-02 ESCALADE (98-06 SEVILLE II (K) SEVILLE III (6K SEVILLE IV (97- SRX (04-08) STS (04-) XLR (04-09)
		CHEVROLET	ALERO (99-04) BLAZER (S10) (9 CAVALIER (91-03 EXPRESS (95-98) MALIBU (96-05) S10 Pick Up (94
		FORD	COUGAR (98-01) FIESTA IV (95-0 KA (96-08) MONDEO I (93-96 MONDEO II (96-0 MONDEO III (00- SCORPIO I (85-9 SIERRA (87-93)
		FORD USA	AEROSTAR (85-97 BRONCO II (85-9 EXPLORER (93-01 F150 (96-03) MUSTANG (93-) MUSTANG (04-) TAURUS (88-92) TAURUS (91-95) TAURUS (95-) THUNDERBIRD (93 WINDSTAR (95-)
		GMC	JIMMY (94-02)
		HOLDEN	STATESMAN (99-0
		HUMMER	HUMMER H2 (02-) HUMMER H3 (05-)
		LAND ROVER	DISCOVERY III (
		MAZDA	5 (05-) 6 (02-07) 6 (07-) 121 III (96-03) MPV II (99-06) MX-5 III (05-) TRIBUTE (00-08)
		PONTIAC	BONNEVILLE (86- TRANS SPORT (97

DENSO P/N	TT	MAKE	MODEL
IT16TT	-	SAAB	9-7X (05-)
<i>continued</i>			
IT20	IT20TT	DE LOREAN	DMC-12 (81-83)
		FORD	FIESTA I (76-86 GT (03-) MAVERICK (01-)
		MAZDA	6 (02-07) MPV II (99-06) TRIBUTE (00-08)
IT20TT	-	ALPINE	A310 (71-84)
		ASTON MARTIN	DB9 (04-) VANQUISH (01-07
		AUDI	100 (4A, C4) (9 A6 (4A, C4) (94 A8 (4D) (94-02) V8 (44, 4C) (88
		AUSTIN	AMBASSADOR (82-
		CHEVROLET	AVALANCHE (00-0 SILVERADO (99-) TAHOE (99-06) TRANS SPORT (96
		CITROËN	BX (82-94) C15 (84-05) CX I (74-85) CX II (85-92) GS (70-86) LNA (76-86) VISA (78-91)
		DE LOREAN	DMC-12 (81-83)
		FORD	C-MAX I (07-) ESCORT III (80- ESCORT IV (85-9 ESCORT V (90-94 ESCORT VI (92-9 ESCORT VII (95- FIESTA I (76-86 FIESTA II (83-9 FIESTA III (89- FIESTA IV (95-0 FIESTA V (01-08 FOCUS C-MAX (03 FOCUS I (98-05) FOCUS II (04-) GALAXY (06-) GT (03-) MAVERICK (01-) MONDEO III (00- MONDEO IV (07-) ORION II (85-90 ORION III (90-9 SCORPIO I (85-9 S-MAX (06-) TRANSIT (06-)
		FORD USA	EXCURSION (99-0 EXPLORER (93-01 PROBE I (88-93) WINDSTAR (95-)
		GMC	SIERRA (97-07) SUBURBAN (99-)
		JAGUAR	S-TYPE (99-08) XF (08-) XJ (94-97) XJ (03-09) XJ (09-) XJ Coupe (73-96 XJSC (85-96) XK 8 (96-05) X-TYPE (01-09)
		LDV	SHERPA (74-89)
		MAZDA	3 (00-09) 5 (05-)

DENSO P/N	TT	MAKE	MODEL
IT20TT	-		6 (02-07)
<i>continued</i>			MPV II (99-06)
			MPV III (06-)
			TRIBUTE (00-08)
		MERCEDES-BENZ	190 (W201) (82-)
			COUPE (C123) (7)
			COUPE (C124) (8)
			E-CLASS (124) (
			G-CLASS (W460)
			G-CLASS (W461)
			G-CLASS (W463)
			KOMBI (S123) (7)
			KOMBI (S124) (8)
			Saloon (W123) (
			Saloon (W124) (
			S-CLASS (W126)
			SL (R107) (71-8
			SL (R129) (89-0
			T1 (601) (77-96
		MERCURY	GRAND MARQUIS (
		MORGAN	ROADSTER (04-)
		MORRIS	ITAL (80-84)
		PEUGEOT	104 (72-88)
			205 I (83-94)
			205 II (87-98)
			305 I (77-82)
			305 II (82-90)
			309 I (85-89)
			504 (68-89)
			505 (79-95)
			604 (77-87)
		PONTIAC	TRANS SPORT (89
		PROTON	GEN 2 (04-)
		PUCH	G-MODELL (W460)
			G-MODELL (W461)
			G-MODELL (W463)
		RENAULT	5 (72-85)
			14 (76-83)
			18 (78-93)
			20 (75-83)
			21 (86-95)
			25 (84-93)
			30 (75-86)
			ESPACE I (84-92
			ESPACE II (91-9
			FUEGO (80-85)
			MASTER I (80-98
			SAFRANE I (92-9
			TRAFIC (89-01)
		ROVER	2000-3500 (76-8
		SHELBY	SERIES 1 (98-)
		TALBOT	SAMBA (81-86)
			TAGORA (80-87)
		TVR	S (86-96)
		VOLVO	260 (74-82)
			760 (81-92)
			780 (86-90)
			C30 (06-12)
			S40 II (04-)
			S80 II (06-)
			V50 (04-)
			V70 III (07-)
IT22	-	ALPINE	V6 (85-90)
		RENAULT	21 (86-95)
IT27	-	RENAULT	5 (72-85)
ITF16TT	-	AC	ACE (95-98)
			COBRA IV (90-)
		CHEVROLET	ASTRO (84-94)
			BLAZER (S10) (8
			BLAZER (S10) (9
			C1500 (91-00)

DENSO P/N	TT	MAKE	MODEL
ITF16TT	-		C2500 (91-96)
<i>continued</i>			CAMARO (70-81)
			CAMARO (81-92)
			CAPRICE (70-83)
			CAPRICE (81-90)
			MALIBU (80-83)
			S10 Pick Up (83
			S10 Pick Up (94
		FORD USA	ECONOLINE (76-9
		GMC	G SERIE (75-84)
		PONTIAC	FIREBIRD (81-92
			TRANS SPORT (89
ITF20TT	-	CHEVROLET	C2500 (96-)
			CAMARO (92-02)
			C-K SERIE (94-0
			SUBURBAN (91-00
		PONTIAC	FIREBIRD (81-92
			FIREBIRD (92-)
ITL16	ITL16TT	CHEVROLET	CAPTIVA (06-)
			HHR (06-11)
		CHRYSLER	300 C (04-12)
			CIRRUS (00-07)
			GRAND VOYAGER (
			PT CRUISER (00-
			SEBRING (01-07)
			VOYAGER (00-08)
		DODGE	CARAVAN (00-07)
			CHARGER (05-10)
			DURANGO (03-10)
			DURANGO (11-)
			RAM (01-08)
			RAM (08-)
		JEEP	CHEROKEE (01-08
			COMMANDER (05-1
			GRAND CHEROKEE
			GRAND CHEROKEE
			WRANGLER II (96
		OPEL	ANTARA (06-)
		VAUXHALL	ANTARA (06-)
ITL16TT	-	CHEVROLET	CAPTIVA (06-)
			HHR (06-11)
		CHRYSLER	300 C (04-12)
			CIRRUS (00-07)
			GRAND VOYAGER (
			PT CRUISER (00-
			SEBRING (01-07)
			VOYAGER (00-08)
		DODGE	CARAVAN (00-07)
			CHARGER (05-10)
			DURANGO (03-10)
			DURANGO (11-)
			RAM (01-08)
			RAM (08-)
		JEEP	CHEROKEE (01-08
			COMMANDER (05-1
			GRAND CHEROKEE
			GRAND CHEROKEE
			WRANGLER II (96
		OPEL	ANTARA (06-)
		VAUXHALL	ANTARA (06-)
ITL20	-	CHRYSLER	300 C (04-12)
			300 M (98-04)
			SEBRING (01-07)
			SEBRING (07-10)
		DODGE	AVENGER (07-)
			CHARGER (05-10)
			CHARGER (11-)
			JOURNEY (08-)
		JEEP	GRAND CHEROKEE
			WRANGLER III (0
ITV16	ITV16TT	FORD	GALAXY (06-)

Spark & Glow Plugs

Buyers Guide

DENSO P/N	TT	MAKE	MODEL
ITV16	ITV16TT		MONDEO IV (07-)
<i>continued</i>			S-MAX (06-)
		MAZDA	3 (00-09)
			3 (09-)
			5 (05-)
			6 (02-07)
			6 (07-)
			CX-9 (07-)
		SAAB	9-5 (97-)
			9-5 (10-)
ITV16TT	-	ALFA ROMEO	159 (05-11)
			BRERA (06-)
			SPIDER (06-)
		CADILLAC	CTS (02-07)
			CTS (08-)
			SRX (04-08)
			STS (04-)
		CHEVROLET	CAPTIVA (06-)
			TRAILBLAZER (01)
		FIAT	CROMA (05-)
		FORD	B-MAX (12-)
			C-MAX I (07-)
			C-MAX II (10-)
			COUGAR (98-01)
			ESCORT V (90-94)
			ESCORT VI (92-9)
			ESCORT VII (95-)
			FIESTA III (89-)
			FIESTA IV (95-0)
			FIESTA V (01-08)
			FIESTA VI (08-)
			FOCUS C-MAX (03)
			FOCUS I (98-05)
			FOCUS II (04-)
			FOCUS III (11-)
			FUSION (02-)
			GALAXY (06-)
			GRAND C-MAX (10)
			KA (96-08)
			MAVERICK (01-)
			MONDEO I (93-96)
			MONDEO II (96-0)
			MONDEO IV (07-)
			ORION III (90-9)
			P 100 (87-92)
			PUMA (97-02)
			S-MAX (06-)
			STREET KA (03-0)
			TOURNEO Connect
			TRANSIT CONNECT
		FORD USA	ESCAPE (01-07)
		HUMMER	HUMMER H3 (05-)
		MAZDA	2 (03-)
			3 (00-09)
			3 (09-)
			5 (05-)
			6 (02-07)
			6 (07-)
			121 III (96-03)
			CX-9 (07-)
			TRIBUTE (00-08)
		MORGAN	FOUR FOUR (68-)
			PLUS FOUR (85-)
		OPEL	ANTARA (06-)
			ASTRA G (98-09)
			SPEEDSTER (00-)
			VECTRA B (95-03)
			VECTRA C (02-)
			ZAFIRA A (99-05)
		RENAULT	19 I (88-92)
		SAAB	9-5 (97-)

DENSO P/N	TT	MAKE	MODEL
ITV16TT	-		9-5 (10-)
<i>continued</i>		SUZUKI	GRAND VITARA (0)
		VAUXHALL	ANTARA (06-)
			ASTRA IV (G) (9)
			SPEEDSTER (VX22)
			VECTRA I (B) (9)
			VECTRA II (C) (
			ZAFIRA I (A) (9)
		VOLVO	C30 (06-12)
			S40 II (04-)
			V50 (04-)
		WESTFIELD	130 (97-)
			ZE (93-97)
ITV20	ITV20TT	CHEVROLET	CAPTIVA (06-)
		CHRYSLER	300 C (11-)
			GRAND VOYAGER (
		DODGE	JOURNEY (08-)
		FIAT	FREEMONT (11-)
		FORD	C-MAX II (10-)
			FIESTA VI (08-)
			FOCUS III (11-)
			FUSION (02-)
			GALAXY (06-)
			GRAND C-MAX (10)
			KUGA II (13-)
			MONDEO IV (07-)
			S-MAX (06-)
		JEEP	GRAND CHEROKEE
			WRANGLER III (0)
		LANCIA	THEMA (11-)
			VOYAGER (11-)
		MAZDA	3 (00-09)
			3 (09-)
			5 (05-)
			5 (10-)
			6 (07-)
			MX-5 III (05-)
		MITSUBISHI	HIMIKO (08-)
		OPEL	ASTRA J (09-)
			GT (07-)
			INSIGNIA (08-)
		SAAB	9-5 (10-)
		VAUXHALL	ANTARA (06-)
			INSIGNIA (08-)
		VOLVO	S60 II (10-)
			S80 II (06-)
			V40 (12-)
			V60 (10-)
			V70 III (07-)
			XC60 (08-)
ITV20TT	-	CHEVROLET	CAPTIVA (06-)
		CHRYSLER	300 C (11-)
			GRAND VOYAGER (
		DODGE	JOURNEY (08-)
		FIAT	FREEMONT (11-)
		FORD	C-MAX II (10-)
			FIESTA VI (08-)
			FOCUS III (11-)
			FUSION (02-)
			GALAXY (06-)
			GRAND C-MAX (10)
			KUGA II (13-)
			MONDEO IV (07-)
			S-MAX (06-)
		JEEP	GRAND CHEROKEE
			WRANGLER III (0)
		LANCIA	THEMA (11-)
			VOYAGER (11-)
		MAZDA	3 (00-09)
			3 (09-)
			5 (05-)

DENSO P/N	TT	MAKE	MODEL
ITV20TT	-		5 (10-)
<i>continued</i>			6 (07-)
			MX-5 III (05-)
		MITSUOKA	HIMIKO (08-)
		OPEL	ASTRA J (09-)
			GT (07-)
			INSIGNIA (08-)
		SAAB	9-5 (10-)
		VAUXHALL	ANTARA (06-)
			INSIGNIA (08-)
		VOLVO	S60 II (10-)
			S80 II (06-)
			V40 (12-)
			V60 (10-)
			V70 III (07-)
			XC60 (08-)
ITV22	-	FORD	FIESTA VI (08-)
			GALAXY (06-)
			MONDEO IV (07-)
			S-MAX (06-)
		JAGUAR	XF (08-)
			XJ (09-)
		LAND ROVER	FREELANDER II (
			RANGE ROVER Evo
		MAZDA	3 (00-09)
			3 (09-)
			6 (02-07)
			CX-7 (07-)
			CX-9 (07-)
		VOLVO	S60 II (10-)
			V60 (10-)
ITV24	-	FORD	FOCUS I (98-05)
IU22	-	ALFA ROMEO	145
			147 (00-10)
			155 (92-97)
			156 (97-06)
			166 (98-07)
			GT (03-10)
			GTV (95-05)
			SPIDER (94-05)
		FERRARI	F50 (95-97)
			F355 (94-00)
IU24	-	FERRARI	360 Modena (99-
			599 GTB
			ENZO (02-03)
			F430 (Spider) (
		MASERATI	GRAN TURISMO (0
			GRANSPORT (03-)
			MC 12 (04-)
			QUATTROPORTE V
			SPYDER Coupe (0
			SPYDER GT (01-)
IU27	-	MASERATI	3200 GT (98-02)
			KARIF (88-)
			QUATTROPORTE IV
IW16	IW16TT	AUDI	80 (81, 85, B2)
		BENTLEY	BROOKLANDS (92-
			EIGHT (84-92)
			MULSANNE (80-92)
		MAZDA	B-SERIE (81-85)
			B-SERIE (85-99)
		OPEL	VECTRA A (88-95)
		PROTON	AEROBACK (88-96)
		ROLLS-ROYCE	CORNICHE (93-02)
			SILVER Spirit (
		TOYOTA	DYNA (01-)
IW16TT	-	ARO	10 (80-06)
			SPARTANA (99-06)
		ASIA MOTORS	ROCSTA (89-99)
		AUDI	80 (81, 85, B2)
			80 (89, 8A, B3)

DENSO P/N	TT	MAKE	MODEL
IW16TT	-		80 (8C, B4) (91
<i>continued</i>			90 (89, 8A, B3)
			100 (44, C3) (8
			100 (4A, C4) (9
			A6 (4A, C4) (94
			CABRIOLET (8G7)
			COUPE (81, 85)
			COUPE (89, 8B)
		AUSTIN	METRO (80-90)
		BENTLEY	BROOKLANDS (92-
			CONTINENTAL (84
			CONTINENTAL (91
			EIGHT (84-92)
			MULSANNE (80-92)
			TURBO R (88-98)
		BMW	02 (E6, E10) (6
			3 (E21) (75-84)
			3 (E30) (82-94)
			5 (E12) (72-81)
			5 (E28) (81-87)
			5 (E34) (87-97)
			6 (E24) (76-90)
			7 (E23) (77-86)
			7 (E32) (86-94)
			1500-2000 (62-7
			1600 GT (67-69)
			Z1 (88-91)
		CHEVROLET	AVEO (T250, T25
			KALOS (05-)
			SPARK (00-04)
			SPARK (05-)
		CHRYSLER	LE BARON (86-96
			SARATOGA (89-95
			VOYAGER (87-90)
			VOYAGER (90-95)
			VOYAGER (95-01)
		DACIA	NOVA (96-03)
		DAEWOO	GENTRA (02-05)
			KALOS (02-)
			MATIZ (98-)
			TICO (95-00)
		DAIHATSU	CHARADE I (77-8
			CHARADE II (83-
			CHARADE III (87
			CHARADE IV (93-
			CHARMANT (81-87
			CUORE IV (94-99
			HIJET (86-90)
			HIJET (92-)
			MOVE (94-)
			ROCKY (85-98)
		DAIMLER	2.8 - 5.3 (69-9
			COUPE (73-77)
			LANDAULETTE (74
			LIMOUSINE (68-9
		DODGE	CARAVAN (89-90)
			CARAVAN (95-02)
		FIAT	DUCATO (82-90)
			DUCATO (89-94)
		GAZ	GAZELLE (93-01)
			VOLGA (93-10)
		GEELY	HQ (05-)
		HONDA	ACCORD I (78-83
			ACCORD II (83-8
			JAZZ I (83-86)
			PRELUDE I (78-8
			QUINTET (80-84)
		HYUNDAI	GALLOPER (98-03
			H-1
			SANTA FÉ I (00-
			SANTAMO (99-)

Spark & Glow Plugs

Buyers Guide

DENSO P/N	TT	MAKE	MODEL
IW16TT	-		SONATA II (88-9)
<i>continued</i>			SONATA III (93-
			SONATA IV (98-0
		INNOCENTI	MINI (74-95)
		JAGUAR	E-TYPE 2+2 (66-
			E-TYPE (61-75)
			Mk X (61-70)
			XJ (68-93)
		JEEP	CHEROKEE (80-86
		KIA	AVELLA (95-01)
			PRIDE (90-)
			RIO I (00-05)
			SEPHIA (93-97)
			SORENTO I (02-)
		LAND ROVER	88
			90
			DEFENDER (90-)
			RANGE ROVER I (
			RANGE ROVER II
		LDV	SHERPA (74-89)
		MARUTI	800 (91-06)
		MAZDA	121 I (87-90)
			121 II (90-97)
			323 C IV (89-00
			323 F IV (87-94
			323 I (77-86)
			323 II (80-89)
			323 III (85-95)
			323 S IV (89-94
			616 (73-78)
			626 I (79-82)
			626 II (82-87)
			626 III (87-97)
			929 III (87-91)
			B-SERIE (77-82)
			B-SERIE (81-85)
			B-SERIE (85-99)
			E-SERIE (SD) (8
			E-SERIE (SR) (8
			E-SERIE (80-84)
		MERCEDES-BENZ	Saloon (W123) (
		MG	MIDGET (64-79)
		MITSUBISHI	COLT I (78-84)
			COLT III (88-92
			COLT IV (92-96)
			COLT V (95-03)
			GALANT II (80-8
			GALANT III (84-
			L 300 (80-87)
			L 300 (86-)
			LANCER I (79-83
			LANCER II (83-8
			LANCER IV (88-9
			LANCER V (91-03
			LANCER VI (95-0
			PAJERO I (82-91
			PAJERO II (90-0
		NISSAN	BLUEBIRD (85-92
			CABSTAR (92-11)
			CHERRY I (E10)
			CHERRY II (N10)
			CHERRY III (N12
			DATSUN 100 A (7
			DATSUN 120 (74-
			DATSUN 120 Y (6
			LAUREL (77-83)
			LAUREL (81-85)
			LAUREL (84-89)
			MICRA I (82-92)
			PATROL (84-96)
			PATROL GR I (87

DENSO P/N	TT	MAKE	MODEL
IW16TT	-		PICK UP (80-86)
<i>continued</i>			PICK UP (85-98)
			SUNNY (70-82)
			SUNNY I (82-90)
			SUNNY II (86-91
			TERRANO I (87-9
			URVAN (81-98)
			VANETTE (81-87)
			VANETTE (86-95)
		OPEL	ASCONA C (81-88
			CALIBRA (90-97)
			COMBO (94-01)
			COMMODORE C (78
			CORSA A (82-93)
			CORSA B (93-00)
			OMEGA A (86-94)
			VECTRA A (88-95
		PLYMOUTH	VOYAGER (89-90)
		PROTON	AEROBACK (88-96
			JUMBUCK (02-)
			PERSONA 400 (94
			SATRIA (96-)
			WIRA (00-)
		RELIANT	KITTEN (75-83)
		RENAULT	11 (83-88)
			16 (65-80)
			19 I (88-92)
			19 II (92-01)
			CLIO I (90-98)
			ESPACE III (96-
			FUEGO (80-85)
			MEGANE I (96-03
			RAPID (85-98)
			SUPER 5 (84-96)
			TRAFIC (80-89)
			TWINGO I (93-)
		ROLLS-ROYCE	CORNICHE (93-02
			SILVER Spirit (
		ROVER	MINI-Moke (86-)
		SANTANA	SAMURAI (86-95)
		SUZUKI	ALTO I (82-85)
			ALTO II (86-93)
			ALTO III (93-02
			CARRY (80-85)
			LJ 80 (80-84)
			SAMURAI (88-04)
			SJ 410 (81-88)
			SJ 413 (84-90)
			SUPER CARRY (85
			VITARA (88-99)
		TOYOTA	4 RUNNER (N5) (
			CAMRY (83-88)
			CAMRY (86-91)
			CARIBE (84-03)
			CARINA (73-83)
			CARINA II (83-9
			CELICA (73-78)
			CELICA (77-85)
			CELICA (85-89)
			COASTER (77-82)
			COASTER (82-93)
			COROLLA (E7) (7
			COROLLA (E8) (8
			COROLLA (E9) (8
			COROLLA (E10) (
			COROLLA (E11) (
			COROLLA (KE) (7
			COROLLA FX (84-
			CORONA (70-87)
			CRESSIDA (77-81
			CRESSIDA (80-93

DENSO P/N	TT	MAKE	MODEL
IW16TT	-		CRESTA (84-01)
<i>continued</i>			DYNA 100 (85-95)
			DYNA 150 (85-88)
			DYNA (77-87)
			DYNA (01-)
			HIACE I (77-85)
			HIACE II (83-89)
			HIACE III (87-0)
			HILUX I (72-83)
			HILUX II (83-05)
			LAND CRUISER (J)
			LAND CRUISER (J)
			LAND CRUISER (J)
			LAND CRUISER
			LITEACE (79-86)
			LITEACE (84-92)
			LITEACE (92-97)
			MODELL F (82-90)
			SPRINTER (82-02)
			STARLET (P6) (7)
			STARLET (P7) (8)
			STARLET (P8) (8)
			STARLET 1000 (7)
			SUPRA (81-85)
			TERCEL (79-88)
		TRIUMPH	2000 (68-77)
			2500 (74-77)
			SPITFIRE (62-80)
			STAG (70-77)
		VAUXHALL	CALIBRA (90-97)
			CARLTON III (86)
			CAVALIER II (81)
			CAVALIER III (8)
			CORSA I (B) (93)
			RASCAL (86-93)
		VOLVO	340-360 (75-91)
			440 (88-96)
			460 (88-96)
			480 (86-96)
		VW	CADDY I (14) (8)
			GOLF I (17, 155)
			GOLF III (1H, 1)
			GOLF IV (1J, 1E)
			JETTA I (16) (7)
			LUPO (6X, 6E) (
			PASSAT (3A2, 35)
			PASSAT (32B) (8)
			SANTANA (81-85)
			SCIROCCO (53) (
			SCIROCCO (53B)
			TARO (89-97)
			TRANSPORTER IV
			VENTO (1H2) (91)
		ZASTAVA	YUGO (80-95)
IW20	IW20TT	AUDI	COUPE (81, 85)
		CITROËN	C25 (81-94)
		FIAT	127 (71-86)
			131 (74-84)
			FIORINO (77-87)
			TIPO (87-95)
		ISUZU	PIAZZA (85-90)
		MASERATI	BORA (71-80)
			GHIBLI I (67-73)
			INDY (69-74)
			MEXICO (67-72)
			QUATTROPORTE II
		MITSUBISHI	LANCER IV (88-9
		PORSCHE	911 (964) (88-9
		PROTON	PERSONA 300 (96
		RELIANT	SCIMITAR (68-90
		RENAULT	19 II (92-01)

DENSO P/N	TT	MAKE	MODEL
IW20	IW20TT		LAGUNA I (93-01)
<i>continued</i>		VAUXHALL	CAVALIER II (81)
			CAVALIER III (8)
		VW	GOLF II (19, 1G)
IW20TT	-	ALFA ROMEO	75 (85-92)
			155 (92-97)
			164 (87-98)
			1750-2000 (68-7
			GIULIA (62-78)
			GT (63-77)
		ALPINA	B9 (E24) (82-85
			B9 (E28) (81-85
			B10 (E34) (88-9
		ASTON MARTIN	DB6 (64-70)
			DBS (66-72)
			LAGONDA (76-97)
		AUDI	50 (86) (74-78)
			80 (80, 82, B1)
			80 (81, 85, B2)
			80 (89, 8A, B3)
			80 (8C, B4) (91
			90 (81, 85, B2)
			90 (89, 8A, B3)
			100 (43, C2) (7
			100 (44, C3) (8
			100 (4A, C4) (9
			100 (C1) (68-76
			200 (43) (79-82
			200 (44) (83-91
			A6 (4A, C4) (94
			CABRIOLET (8G7)
			COUPE (81, 85)
			COUPE (89, 8B)
			QUATTRO (85) (8
		AUSTIN	1000-Series (70
			ALLEGRO (73-84)
			MAESTRO (83-92)
			MAXI (69-82)
			METRO (80-90)
			MINI (60-93)
			MONTEGO (84-92)
			PRINCESS (76-82
		AUSTIN-HEALEY	AUSTIN-HEALEY (
		AUTOBIANCHI	A 112 (69-85)
			Y10 (85-95)
		BEDFORD	MIDI (84-92)
		BENTLEY	CONTINENTAL (91
			TURBO R (88-98)
		BMW	02 (E6, E10) (6
			3 (E21) (75-84)
			3 (E30) (82-94)
			5 (E12) (72-81)
			5 (E34) (87-97)
			1500-2000 (62-7
			2000 (E9) (65-7
		CHEVROLET	AVEO (T250, T25
			KALOS (05-)
			LANOS (05-)
			NIVA (2121) (02
		CHRYSLER	VOYAGER (95-01)
			VOYAGER (00-08)
		CITROËN	C25 (81-94)
			GS (70-86)
		DACIA	NOVA (96-03)
		DAEWOO	CIELO (94-98)
			ESPERO (91-99)
			GENTRA (02-05)
			KALOS (02-)
			LACETTI (97-99)
			LANOS (97-)
			NEXIA (95-08)

Spark & Glow Plugs

Buyers Guide

DENSO P/N	TT	MAKE	MODEL
IW20TT	-		NEXIA (08-)
<i>continued</i>			TACUMA
		DAIHATSU	CHARADE II (83- CHARADE III (87 CUORE I (80-85) CUORE II (85-90 CUORE III (90-9 CUORE V (96-98) EXTOL (00-)
		DODGE	CARAVAN (95-02)
		FIAT	126 (72-00) 127 (71-86) 128 (69-84) 131 (74-84) 132 (72-82) 900 T 900 T ARGENTA (78-86) CINQUECENTO (91 CROMA (85-96) DUCATO (82-90) DUNA (87-91) FIORINO (77-87) FIORINO (80-93) FIORINO (88-01) PANDA (80-04) REGATA (83-90) RITMO (78-88) RITMO Bertone (SEICENTO (98-10 TALENTO (89-94) TEMPRA (90-96) TIPO (87-95) UNO (83-00) X 1/9 (73-89)
		FORD	GRANADA (72-85) SIERRA (82-87) TAUNUS (75-79)
		FSO	125P (67-92) 126P (72-00) 127P (69-76) LANOS (04-08) POLONEZ I (77-9 POLONEZ II (88-
		HONDA	ACCORD II (83-8 ACCORD III (85- ACTY (79-86) CIVIC I (72-84) CIVIC II (79-83 CIVIC III (83-8 CRX I (83-87) INTEGRA (85-93) PRELUDE II (83-
		HYUNDAI	H-1 H100 (93-04) LANTRA I (90-95 PONY PONY (74-82) PONY (85-89) S COUPE (90-96) SANTA FÉ I (00- SANTAMO (99-) SONATA II (88-9 SONATA III (93- SONATA IV (98-0 STELLAR (83-91) TRAJECT (00-08)
		INNOCENTI	ELBA (91-96) MINI (74-95)
		ISUZU	ASKA (95-01) CAMPO (77-91)

DENSO P/N	TT	MAKE	MODEL
IW20TT	-		MIDI (88-)
<i>continued</i>			PIAZZA (85-90) PICK UP (87-96) TROOPER (83-91)
		KIA	JOICE (00-) MAGENTIS (01-) 110 (95-) 111 (95-) 112 (95-) 1200-1500 (73-8 1200-1600 (70-9 GRANTA (11-) KALINA (04-) NIVA (2121) (76 NIVA II (2123) NOVA (81-) SAMARA (86-) TOSCANA (83-12)
		LADA	BETA (73-86) BETA H.P.E. (76 BETA Monte Carl DEDRA (89-99) DELTA I (79-94) DELTA II (93-99 KAPPA (94-01) THEMA (84-94) TREVI (80-87) Y10 (85-95)
		LANCIA	DEFENDER (90-) DISCOVERY I (89 RANGE ROVER I (ECLAT (75-86) ELITE (74-82) ESPRIT S2 (75-8 ESPRIT S3 (80-8 ESPRIT S4 (89-0 EXCEL (83-91) BORA (71-80) GHIBLI I (67-73 INDY (69-74) MEXICO (67-72) QUATTROPORTE II
		LAND ROVER	323 C IV (89-00 323 I (77-86) 323 III (85-95) 323 S IV (89-94 626 I (79-82) 626 II (82-87) 818 (74-78) 929 I (79-86) 929 II (82-87) 1300 (75-77) B-SERIE (99-)
		LOTUS	COUPE (C123) (7 G-CLASS (W460) G-CLASS (W463) KOMBI (S123) (7 Saloon (W123) (S-CLASS (W116) S-CLASS (W126) S-CLASS Coupe (SL (R107) (71-8 SLC (C107) (72- T1 (601) (77-96 1300 II (67-70) MAESTRO (83-90) METRO (82-90) MGB (66-80) MGC (67-69) MONTEGO (84-90) COLT I (78-84)
		MASERATI	
		MAZDA	
		MERCEDES-BENZ	
		MG	
		MITSUBISHI	

DENSO P/N	TT	MAKE	MODEL
IW20TT	-		COLT II (84-88)
<i>continued</i>			COLT III (88-92)
			CORDIA (82-89)
			DEBONAIR (92-97)
			ECLIPSE I (89-9)
			ECLIPSE II (94-
			GALANT I (77-80
			GALANT II (80-8
			GALANT III (84-
			GALANT IV (87-9
			GALANT V (92-96
			L 200 (80-86)
			L 200 (86-96)
			L 200 (96-07)
			L 300 (80-87)
			L 300 (86-)
			L 300 (94-00)
			L 400
			LANCER I (79-83
			LANCER III (83-
			LANCER IV (88-9
			LANCER VII (03-
			MIRAGE (88-91)
			OUTLANDER I (03
			SANTAMO (99-04)
			SAPORO I (78-8
			SAPORO II (80-
			SIGMA (90-96)
			SPACE WAGON (83
			SPACE WAGON (91
			STARION (82-90)
		MORGAN	PLUS EIGHT (68-
		MORRIS	MARINA (71-80)
			MINI (60-81)
		MOSKOVICH	412 (71-)
			21412 (89-01)
		NISSAN	BLUEBIRD (80-86
			BLUEBIRD (83-90
			BLUEBIRD (85-92
			CEDRIC (83-87)
			CHERRY II (N10)
			CHERRY III (N12
			DATSUN 180 B (7
			FIGARO (91-92)
			LAUREL (77-83)
			LAUREL (81-85)
			PATHFINDER (86-
			PATROL (79-88)
			PICK UP (80-86)
			PRAIRIE (83-88)
			SILVIA (84-88)
			STANZA (81-85)
			SUNNY (70-82)
			SUNNY I (82-90)
			SUNNY II (86-91
			URVAN (81-98)
			VANETTE (81-87)
			VANETTE (86-95)
		OPEL	ASCONA B (75-81
			ASCONA C (81-88
			ASTRA F (91-01)
			CAMPO (87-)
			CORSA A (82-93)
			KADETT D (79-84
			KADETT E (84-94
			MANTA A (70-75)
			MANTA B (75-88)
			OMEGA A (86-94)
			REKORD E (77-86
			VECTRA A (88-95
		PEUGEOT	504 (68-89)

DENSO P/N	TT	MAKE	MODEL
IW20TT	-		505 (79-95)
<i>continued</i>			J5 (81-90)
			J5 (90-94)
			J7 (68-80)
			J9 (80-87)
		PIAGGIO	PORTER (93-)
		PININFARINA	SPIDEREUROPA (8
		PLYMOUTH	VOYAGER (95-01)
		PORSCHE	911 (964) (88-9
			924 (75-89)
			944 (81-91)
			968 (91-95)
		PROTON	AEROBACK (88-96
			PERSONA 300 (96
			PERSONA 400 (94
			SAGA I (88-07)
			SALOON (91-96)
		PUCH	G-MODELL (W460)
		RELIANT	SCIMITAR (68-90
		RENAULT	4 (62-93)
			5 (72-85)
			6 (69-87)
			8 (62-72)
			9 (81-89)
			10 (66-72)
			11 (83-88)
			12 (69-80)
			16 (65-80)
			18 (78-93)
			19 I (88-92)
			19 II (92-01)
			20 (75-83)
			21 (86-95)
			CLIO I (90-98)
			ESTAFETTE (62-8
			FUEGO (80-85)
			LAGUNA I (93-01
			MASTER I (80-98
			MEGANE I (96-03
			MEGANE Scénic (
			RAPID (85-98)
			RODEO 6 (70-81)
			SUPER 5 (84-96)
			TRAFIC (80-89)
			TRAFIC (89-01)
		RILEY	ELF III (63-68)
		ROVER	200 (XH) (85-89
			MAESTRO (90-95)
			MINI (91-01)
			MONTEGO (84-95)
		SAAB	90 (84-87)
			99 (68-84)
			900 I (78-94)
		SANTANA	SAMURAI (86-95)
		SEAT	AROSA (6H) (97-
			CORDOBA (6K1) (
			CORDOBA (6K2) (
			FURA (82-86)
			IBIZA I (84-93)
			IBIZA II (6K1)
			IBIZA III (6K2)
			INCA (6K9) (95-
			MARBELLA (86-98
			PANDA (80-86)
			TERRA (87-96)
			TOLEDO I (1L) (
		SKODA	FELICIA Fun (97
			FELICIA I (6U)
			FELICIA II (6U)
			OCTAVIA (1U) (9
		SUBARU	JUSTY I (84-95)

DENSO P/N	TT	MAKE	MODEL
IW20TT	-		JUSTY II (95-03)
<i>continued</i>			LEONE I (78-84)
			LEONE II (84-94)
			LIBERO (83-00)
			MV (78-86)
			REX II (81-89)
		SUZUKI	CARRY (99-)
			SAMURAI (88-04)
			SWIFT I (83-89)
			SWIFT II (89-05)
			WAGON R+ (00-)
		TALBOT	1307-1510 (75-8
			HORIZON (78-86)
			MURENA (80-85)
			RANCHO (77-84)
			SOLARA (80-86)
			TAGORA (80-87)
		TOFAS	DOGAN (76-02)
			KARTAL (91-)
			SAHIN (80-03)
		TOYOTA	1000 (69-88)
			CELICA (73-78)
			CELICA (77-85)
			CELICA Supra (8
			COROLLA (E7) (7
			CRESSIDA (80-93
			CROWN (80-85)
			HIACE III (87-0
			HIACE IV (95-)
			HILUX I (72-83)
			LITEACE (92-97)
			MODELL F (82-90
			STARLET (P7) (8
			STARLET (P8) (8
		TRABANT	1.1 (90-91)
		TVR	350 (83-89)
		VAUXHALL	ASTRA I (79-86)
			ASTRA II (84-94
			ASTRA III (F) (
			BRAVA (88-02)
			CARLTON II (77-
			CARLTON III (86
			CAVALIER I (75-
			CAVALIER II (81
			CAVALIER III (8
			CHEVETTE (75-85
			MIDI II (88-97)
			NOVA (82-94)
		VOLVO	240 (74-93)
			340-360 (75-91)
			440 (88-96)
			460 (88-96)
			740 (83-92)
			760 (81-92)
			940 I (90-95)
			940 II (94-98)
			960 I (90-94)
		VW	CADDY I (14) (8
			CADDY II (9K, 9
			CORRADO (53I) (
			DERBY (86) (77-
			DERBY (86C, 80)
			GOLF I (17, 155
			GOLF II (19, 1G
			GOLF III (1H, 1
			GOLF IV (1J, 1E
			ILTIS (79-88)
			JETTA I (16) (7
			JETTA II (19, 1
			K 70 (70-74)
			LT 28-35 I (281

DENSO P/N	TT	MAKE	MODEL
IW20TT	-		LT 40-55 I (75-
<i>continued</i>			LUPO (6X, 6E) (
			PASSAT (3A2, 35
			PASSAT (32, 33)
			PASSAT (32B) (8
			POLO (6N1) (94-
			POLO (86) (75-8
			POLO (86C, 80)
			POLO Classic (6
			POLO Variant (6
			SANTANA (81-85)
			SCIROCCO (53) (
			SCIROCCO (53B)
			SHARAN (7M) (95
			TRANSPORTER III
			TRANSPORTER IV
			VENTO (1H2) (91
		WARTBURG	353 (66-91)
		WOLSELEY	HORNET (61-70)
		ZASTAVA	101 (73-93)
			YUGO (80-95)
			YUGO Florida (8
		ZAZ	CHANCE (04-)
			LANOS (04-)
			SENS (04-)
			SLAVUTA (95-)
			TAVRIJA (89-)
IW22	-	ASTON MARTIN	V8 (69-93)
		AUDI	200 (43) (79-82
		LOTUS	ESPRIT S2 (75-8
		MASERATI	420
			BITURBO (81-94)
		PORSCHE	911 (901, 911)
		SAAB	900 I (78-94)
IW24	-	FERRARI	208
			412 i (85-88)
			MONDIAL (80-93)
		LAMBORGHINI	COUNTACH (74-91
			ESPADA (68-81)
		MASERATI	BITURBO (81-94)
		PORSCHE	911 (901, 911)
			911 (930) (75-9
			924 (75-89)
		RENAULT	9 (81-89)
			11 (83-88)
			18 (78-93)
			FUEGO (80-85)
			SUPER 5 (84-96)
IW27	-	ALPINE	1600 (69-75)
		LAMBORGHINI	MIURA (69-72)
		PORSCHE	911 (901, 911)
			911 (930) (75-9
IW29	-	FERRARI	208
IWF20	-	VOLVO	340-360 (75-91)
IX22B	-	BMW	5 (E28) (81-87)
IX24	-	BMW	M1 (79-83)
		FERRARI	328 GTB (85-89)
			328 GTS (85-89)
			348 Spider (93-
			348 TB
			348 TS
			MONDIAL (80-93)
			TESTAROSSA (84-
		LAMBORGHINI	COUNTACH (74-91
			LM-002 (83-92)
IXEH20ETT	-	MITSUOKA	VIEWT (K12) (05
		NISSAN	JUKE (10-)
			LATIO (04-)
			MICRA IV (10-)
			TIIDA (04-)
IXEH20TT	-	CITROËN	C1 II (14-)

DENSO P/N	TT	MAKE	MODEL
IXEH20TT	-		C2 (03-)
<i>continued</i>			C3 I (02-)
			C4 Coupe (04-)
			C4 I (LC) (04-)
		DACIA	LOGAN I (04-)
			LOGAN II (12-)
			LOGAN MCV II (1
			SANDERO I (08-)
			SANDERO II (12-
		NISSAN	ALTIMA (06-)
			CUBE (10-)
			ELGRAND (10-)
			KUBISTAR (03-)
			LATIO (04-)
			MICRA C+C (05-)
			MICRA III (03-1
			MICRA IV (10-)
			NOTE (06-)
			NV200 (10-)
			PRIMERA (02-)
			QASHQAI (+2) (0
			SERENA (05-)
			TEANA (08-)
			TIIDA (04-)
			X-TRAIL (07-)
		PEUGEOT	108 (14-)
			206 (98-)
			207 (06-)
			307 (00-)
			1007 (05-)
		RENAULT	CLIO II (98-)
			CLIO III (05-)
			CLIO IV (12-)
			FLUENCE (10-)
			GRAND SCÉNIC II
			KANGOO (97-)
			KOLEOS (08-)
			LAGUNA III (07-
			LATITUDE (10-)
			LOGAN II (13-)
			MEGANE III (08-
			MODUS (04-)
			SCÉNIC III (09-
			THALIA I (98-)
			THALIA II (08-)
			TWINGO I (93-)
			TWINGO II (07-)
		RENAULT SAMSUNG	QM5 (06-)
		TOYOTA	AURIS (12-)
			AYGO (05-)
			AYGO (14-)
			COROLLA (E16) (
			COROLLA (E18) (
			IQ (09-)
			URBAN CRUISER (
			VERSO S (10-)
			YARIS (10-)
IXEH22TT	-	ASTON MARTIN	CYGNET (11-13)
		DAIHATSU	CHARADE VI (11-
		INFINITI	EX (08-)
			FX (03-)
			M (10-)
			M35 (05-)
			QX70 (13-)
		LEXUS	CT (10-)
		LOTUS	ELISE (00-)
		MAZDA	2 (14-)
			3 (13-)
			6 (12-)
			CX-3 (15-)
			CX-5 (11-)

DENSO P/N	TT	MAKE	MODEL
IXEH22TT	-		MX-5 IV (15-)
<i>continued</i>		MERCEDES-BENZ	C-CLASS (204) (
			C-CLASS Coupe (
			CLK (209) (02-1
			CLS (218) (11-)
			CLS (C219) (04-
			E-CLASS (211) (
			M-CLASS (W164)
			R-CLASS (251) (
			S-CLASS (W221)
			S-CLASS Coupe (
			SL (R230) (01-1
		NISSAN	350 Z (02-)
			ELGRAND (10-)
			MURANO (07-)
			PATROL III (10-
			TEANA (08-)
		SUBARU	FORESTER (08-)
			FORESTER (13-)
			IMPREZA (11-)
			TREZIA (11-)
			XV (12-)
		TOYOTA	ALLION I (01-07
			ALLION II (07-)
			AURIS (06-)
			AURIS (12-)
			AVENSIS (09-)
			COROLLA (E12) (
			COROLLA (E14, E
			COROLLA (E16) (
			COROLLA (E18) (
			COROLLA Rumion
			IQ (09-)
			ISIS (04-)
			PREMIO (07-)
			PRIUS (09-)
			PRIUS PLUS (11-
			RAV 4 III (05-)
			RAV 4 IV (12-)
			URBAN CRUISER (
			VERSO (09-)
			VERSO S (10-)
			WISH (09-)
			YARIS (05-)
			YARIS (10-)
IXU22	-	PORSCHE	911 (997) (04-1
		SUZUKI	CAPPUCINO (92-9
IXU27	-	ALFA ROMEO	GIULIETTA (10-)
			MITO (08-)
		CHRYSLER	DELTA (11-)
		FERRARI	456 GT
			550 BARCHETTA (
			550 Maranello (
			575 Maranello (
			612 SCAGLIETTI
		FIAT	500 (C) (07-)
			BRAVO II (06-)
			GRANDE PUNTO (0
			LINEA (07-)
			PUNTO (12-)
			PUNTO EVO (08-1
		LAMBORGHINI	DIABLO (90-)
		LANCIA	DELTA III (08-)
IXUH20I	-	HYUNDAI	i10 (13-)
			i20 (08-)
		KIA	PICANTO (11-)
			RIO III (11-)
		MINI	OUTLANDER III (
IXUH22	-	BMW	1 (F20, F21) (1
			3 (F30, F31) (1
		MINI	MINI (R56) (06-

DENSO P/N	TT	MAKE	MODEL
IXUH22	-		MINI Clubman (R
<i>continued</i>			MINI Convertibl
			MINI Countryman
			MINI Coupe (R58
			MINI Paceman (R
			MINI Roadster (
IXUH22I	-	CITROËN	C3 II (09-)
			C-ELYSEE (12-)
			DS3 (09-)
		PEUGEOT	208 (12-)
			301 (12-)
			2008 (13-)
J16CR-U	W16TT	BMW	3 (E30) (82-94)
			5 (E12) (72-81)
			5 (E28) (81-87)
			5 (E34) (87-97)
			6 (E24) (76-90)
			7 (E32) (86-94)
			Z1 (88-91)
		VOLVO	440 (88-96)
			460 (88-96)
			480 (86-96)
K16GPR-U11	-	FORD	MAVERICK (93-98
		NISSAN	PICK UP (D22) (
			PICK UP (85-98)
			PRAIRIE Pro (88
			TERRANO II (92-
K16HPR-U11	KH16TT	CITROËN	BERLINGO (B9) (
			BERLINGO (MF) (
			C2 (03-)
			C3 I (02-)
			C3 Pluriel (03-
			C4 (Grand) Pica
			C4 Coupe (04-)
			C4 I (LC) (04-)
			C4 II (B7) (09-
			C5 I (01-04)
			C5 II (04-)
			C5 III (08-)
			C8 (02-)
			C-ELYSEE (12-)
			EVASION (94-02)
			JUMPY (95-)
			XSARA (97-05)
			XSARA Picasso (
		FIAT	SCUDO (96-06)
			ULYSSE (94-02)
		HYUNDAI	ix35 (09-)
			SANTA FÉ II (06
			SONATA V (05-)
			SONATA VI (09-)
		KIA	MAGENTIS (05-)
			OPTIMA (11-)
			SORENTO II (09-
			SPORTAGE III (1
		NISSAN	ALMERA II (00-)
			ALMERA TINO (00
			CUBE (03-05)
			PRIMERA (96-02)
			PRIMERA (02-)
			X-TRAIL (01-)
			X-TRAIL (07-)
		PEUGEOT	206 (98-)
			206 CC (00-)
			206+ (09-)
			207 (06-)
			307 (00-)
			406 (95-04)
			407 (04-)
			607 (00-)
			806 (94-02)

DENSO P/N	TT	MAKE	MODEL
K16HPR-U11	KH16TT		807 (02-)
<i>continued</i>			1007 (05-)
			EXPERT (96-)
			EXPERT (07-)
			PARTNER
			PARTNER
		RENAULT	LAGUNA II (01-)
			MEGANE I (96-03
		SUZUKI	GRAND VITARA (0
			SX4 (06-)
K16HR-U11	KH16TT	CITROËN	C1 I (05-)
		MITSUBISHI	COLT VI (04-)
		NISSAN	MICRA III (03-1
		PEUGEOT	107 (05-)
		TOYOTA	AYGO (05-)
			VIOS
			YARIS (05-)
K16PR-U	K16TT	AUDI	A8 (4D) (94-02)
		BMW	3 (E30) (82-94)
		CHERY	QQ3 (03-)
		CITROËN	XSARA (97-05)
			XSARA Picasso (
		FIAT	BRAVA (95-02)
			BRAVO I (95-01)
			DOBLO (01-)
			MAREA (96-07)
			MULTIPLA (99-10
			PALIO (96-)
			PANDA (80-04)
			PANDA (03-)
			PUNTO (99-)
			SEICENTO (98-10
			SIENA (96-)
			STILO (01-08)
			STRADA (99-)
		HYUNDAI	i10 (07-)
		KIA	CLARUS (96-)
			SEPHIA (93-97)
			SHUMA I (96-01)
			SPORTAGE I (94-
		LANCIA	DEDRA (89-99)
			LYBRA (99-05)
			Y (95-03)
			Y10 (85-95)
			YPSILON (843) (
		MAZDA	323 C IV (89-00
			323 F IV (87-94
			323 II (80-89)
		MITSUBISHI	SPACE RUNNER (9
			SPACE WAGON (98
		NISSAN	100 NX (90-94)
			ALMERA I (95-00
			PRIMERA (96-02)
			SERENA (92-01)
			SUNNY III (90-0
			VANETTE CARGO (
		PEUGEOT	106 I (91-96)
			106 II (96-)
			206 (98-)
			306 (93-02)
		SKODA	FELICIA Fun (97
			FELICIA II (6U)
		UAZ	HUNTER (04-)
			PATRIOT (04-)
		ZASTAVA	10 (05-)
K16PR-U11	K16TT	CHERY	TIGGO (05-08)
		DAIHATSU	CUORE VI (98-03
			MOVE (94-)
			SIRION (98-05)
		FIAT	SIENA (96-)
		HYUNDAI	ACCENT I (94-00

DENSO P/N	TT	MAKE	MODEL
K16PR-U11	K16TT		ACCENT II (99-0
<i>continued</i>			ACCENT III (05-
			ATOS (98-)
			ATOS Prime (99-
			COUPE (96-02)
			COUPE (01-09)
			ELANTRA (00-06)
			ELANTRA (05-11)
			GETZ (02-09)
			HIGHWAY VAN (00
			i10 (07-)
			LANTRA II (95-0
			MATRIX (01-10)
			S COUPE (90-96)
			SANTA FÉ I (00-
			SONATA IV (98-0
			SONATA V (05-)
			TERRACAN (01-06
			TRAJECT (00-08)
			TUCSON (04-10)
		INFINITI	QX4 (97-)
		KIA	CARENS II (02-)
			CARENS III (06-
			CERATO (04-)
			MAGENTIS (05-)
			PICANTO (04-)
			RIO II (05-)
			SHUMA I (96-01)
			SHUMA II (01-04
			SPORTAGE II (04
		LANDWIND (JMC)	LANDWIND (05-)
		MAZDA	3 (00-09)
			3 (09-)
			121 II (90-97)
			323 C IV (89-00
			323 C V (94-98)
			323 F V (94-98)
			323 F VI (98-04
			323 I (77-86)
			323 S IV (89-94
			323 S V (94-98)
			323 S VI (98-04
			626 IV (91-97)
			DEMIO (98-03)
			MX-3 (91-98)
			MX-5 II (98-05)
			MX-6 (92-97)
			PREMACY (99-05)
			VERISA (04-)
			XEDOS 6 (92-99)
			XEDOS 9 (93-02)
		MERCEDES-BENZ	E-CLASS (124) (
		MITSUBISHI	COLT IV (92-96)
			COLT V (95-03)
			GALANT V (92-96
			L 200 (96-07)
			L 300 (86-)
			L 400
			LANCER V (91-03
			LANCER VI (95-0
			PAJERO II (90-0
			PAJERO Pinin (9
			SAPPORO III (87
			SPACE STAR (98-
		MITSUOKA	RYOGA (99-)
			VIEWT (K11) (94
			YUGA (99-)
			ZERO I (95-01)
		NISSAN	AD Wagon (99-04
			ALMERA II (00-)
			ALMERA TINO (00

DENSO P/N	TT	MAKE	MODEL
K16PR-U11	K16TT		BLUEBIRD SYLPHY
<i>continued</i>			MICRA II (92-03
			PICK UP (D22) (
			PRIMERA (96-02)
		OPEL	FRONTERA B (98-
		SUBARU	FORESTER (97-02
			LEGACY III (98-
			OUTBACK (00-03)
			VIVIO (92-98)
		VAUXHALL	FRONTERA II (B)
K16PSR-B8	IK16TT	CITROËN	C-CROSSER (07-)
		MITSUBISHI	DELICA (07-)
			OUTLANDER II (0
			OUTLANDER III (
		PEUGEOT	4007 (07-)
K16R-U	K16TT	BMW	3 (E30) (82-94)
			7 (E32) (86-94)
		NISSAN	100 NX (90-94)
			PRIMERA (90-98)
		TOYOTA	4 RUNNER (N10)
			HILUX II (83-05
			LAND CRUISER (J
			PREVIA I (90-00
			YARIS (99-05)
K16R-U11	K16TT	CHRYSLER	CIRRUS (94-00)
			STRATUS (95-01)
			VOYAGER (95-01)
		DODGE	CARAVAN (95-02)
			STRATUS (95-01)
		GEELY	BL (05-)
			CK (05-)
			MR (05-)
		NISSAN	PRIMERA (96-02)
		PLYMOUTH	BREEZE (95-01)
		TOYOTA	ALLION I (01-07
			AURIS (06-)
			AVENSIS (97-03)
			AVENSIS (03-09)
			bB (00-05)
			CARINA E (92-97
			CELICA (99-05)
			COROLLA (E9) (8
			COROLLA (E11) (
			COROLLA (E12) (
			COROLLA (E14, E
			COROLLA Verso (
			CORONA (87-92)
			ECHO (99-05)
			IST (04-07)
			LAND CRUISER
			MR 2 III (99-07
			PLATZ (99-05)
			PORTE I (04-12)
			PROBOX
			RAUM (03-)
			RAV 4 II (00-05
			URBAN CRUISER (
			VIOS
			WILL Cypha (01-
			WILL VS (01-04)
			WISH (03-09)
			YARIS (99-05)
			YARIS (05-)
			YARIS (10-)
			YARIS VERSO (99
K16TNR-S9	K16TT	AUDI	A4 (8E, B6) (00
			A4 (8E, B7) (04
			A4 Convertible
		DAIHATSU	CHARADE V (03-)
			CUORE VII (03-)
			SIRION (98-05)

DENSO P/N	TT	MAKE	MODEL
K16TNR-S9	K16TT		TREVIS (06-)
<i>continued</i>			YRV (01-)
		FIAT	PALIO (96-)
			SIENA (96-)
		MERCEDES-BENZ	C-CLASS (202) (
		PERODUA	KENARI (00-)
		RENAULT	TWINGO I (93-)
		SKODA	FABIA (6Y) (99-
		VW	TRANSPORTER IV
			VENTO (1H2) (91
K16TR11	K16TT	TOYOTA	4 RUNNER (N10)
			COROLLA (E10) (
			COROLLA (E11) (
			CORSA (94-99)
			LAND CRUISER
			PASEO (95-99)
			STARLET (P9) (9
			TERCEL (94-99)
			TUNDRA (99-06)
K16TT	-	ALFA ROMEO	159 (05-11)
		AUDI	A4 (8E, B6) (00
			A4 (8E, B7) (04
			A4 Convertible
			A8 (4D) (94-02)
		BMW	3 (E30) (82-94)
			7 (E32) (86-94)
			8 (E31) (90-99)
		CADILLAC	BLS (06-)
		CHERY	QQ3 (03-)
			TIGGO (05-08)
		CHEVROLET	AVEO (T300) (11
			CRUZE (09-)
			NIVA (2121) (02
			VIVA (03-08)
		CHRYSLER	CIRRUS (94-00)
			SEBRING (07-10)
			STRATUS (95-01)
			VOYAGER (95-01)
		CITROËN	XSARA (97-05)
			XSARA Picasso (
		DAIHATSU	CHARADE V (03-)
			CUORE VI (98-03
			CUORE VII (03-)
			MOVE (94-)
			SIRION (98-05)
			TREVIS (06-)
			YRV (01-)
		DODGE	AVENGER (07-)
			CALIBER (06-)
			CARAVAN (95-02)
			JOURNEY (08-)
			STRATUS (95-01)
		FIAT	BRAVA (95-02)
			BRAVO I (95-01)
			CROMA (05-)
			DOBLO (01-)
			MAREA (96-07)
			MULTIPLA (99-10
			PALIO (96-)
			PANDA (80-04)
			PANDA (03-)
			PUNTO (99-)
			SEICENTO (98-10
			SIENA (96-)
			STILO (01-08)
			STRADA (99-)
		GEELY	BL (05-)
			CK (05-)
			MR (05-)
		HOLDEN	ASTRA G (TS) (9
			ASTRA H (AH) (0

DENSO P/N	TT	MAKE	MODEL
K16TT	-	HONDA	ACCORD VI (97-0
<i>continued</i>			CAPA (98-02)
			CIVIC V (91-97)
			CIVIC VI (94-01
			CIVIC VII (00-0
			CR-V I (95-02)
			HR-V (99-)
			LOGO (99-02)
			ODYSSEY (02-)
		HYUNDAI	ACCENT I (94-00
			ACCENT II (99-0
			ACCENT III (05-
			ATOS (98-)
			ATOS Prime (99-
			COUPE (96-02)
			COUPE (01-09)
			ELANTRA (00-06)
			ELANTRA (05-11)
			GETZ (02-09)
			HIGHWAY VAN (00
			i10 (07-)
			i30 (07-12)
			LANTRA II (95-0
			MATRIX (01-10)
			S COUPE (90-96)
			SANTA FÉ I (00-
			SONATA IV (98-0
			SONATA V (05-)
			TERRACAN (01-06
			TRAJECT (00-08)
			TUCSON (04-10)
		INFINITI	QX4 (97-)
		JEEP	CHEROKEE (84-01
			CJ5 - CJ8 (66-8
			COMANCHE (86-96
			COMMANDER (05-1
			COMPASS (06-)
			GRAND CHEROKEE
			GRAND CHEROKEE
			PATRIOT (07-)
			WRANGLER I (86-
			WRANGLER II (96
		KIA	CARENS II (02-)
			CARENS III (06-
			CEED (06-)
			CERATO (04-)
			CLARUS (96-)
			MAGENTIS (05-)
			PICANTO (04-)
			PRO CEED (08-)
			RIO II (05-)
			SEPHIA (93-97)
			SHUMA I (96-01)
			SHUMA II (01-04
			SPORTAGE I (94-
			SPORTAGE II (04
		LANCIA	DEDRA (89-99)
			LYBRA (99-05)
			Y (95-03)
			Y10 (85-95)
			YPSILON (843) (
		LANDWIND (JMC)	LANDWIND (05-)
		LOTUS	EUROPA S (06-)
		MAZDA	3 (00-09)
			3 (09-)
			121 II (90-97)
			323 C IV (89-00
			323 C V (94-98)
			323 F IV (87-94
			323 F V (94-98)
			323 F VI (98-04

DENSO P/N	TT	MAKE	MODEL
K16TT	-		323 I (77-86)
<i>continued</i>			323 II (80-89)
			323 S IV (89-94)
			323 S V (94-98)
			323 S VI (98-04)
			626 III (87-97)
			626 IV (91-97)
			929 III (87-91)
			B-SERIE (85-99)
			DEMIO (98-03)
			MPV I (95-99)
			MPV II (99-06)
			MX-3 (91-98)
			MX-5 II (98-05)
			MX-6 (92-97)
			PREMACY (99-05)
			VERISA (04-)
			XEDOS 6 (92-99)
			XEDOS 9 (93-02)
		MERCEDES-BENZ	C-CLASS (202) (
			CLK (208) (97-0
			E-CLASS (124) (
			E-CLASS (210) (
			G-CLASS (W463)
			S-CLASS (W140)
			SL (R129) (89-0
		MITSUBISHI	COLT IV (92-96)
			COLT V (95-03)
			GALANT V (92-96
			L 200 (96-07)
			L 300 (86-)
			L 400
			LANCER V (91-03
			LANCER VI (95-0
			MAGNA (96-05)
			PAJERO II (90-0
			PAJERO III (00-
			PAJERO Pinin (9
			PAJERO Sport I
			SAPPORO III (87
			SPACE RUNNER (9
			SPACE STAR (98-
			SPACE WAGON (98
		MITSUOKA	RYOGA (99-)
			VIEWT (K11) (94
			YUGA (99-)
			ZERO I (95-01)
		NISSAN	100 NX (90-94)
			AD Wagon (99-04
			ALMERA I (95-00
			ALMERA II (00-)
			ALMERA TINO (00
			BLUEBIRD SYLPHY
			MICRA II (92-03
			PICK UP (D22) (
			PRIMERA (90-98)
			PRIMERA (96-02)
			SERENA (92-01)
			SUNNY III (90-0
			VANETTE CARGO (
		OPEL	AGILA (00-07)
			ASTRA G (98-09)
			ASTRA H (04-)
			COMBO (01-)
			CORSA C (00-09)
			CORSA D (06-)
			FRONTERA B (98-
			INSIGNIA (08-)
			MERIVA A (03-10
			MOKKA (12-)
			SIGNUM (03-)

DENSO P/N	TT	MAKE	MODEL
K16TT	-		TIGRA TwinTop (
<i>continued</i>			VECTRA C (02-)
			ZAFIRA A (99-05
			ZAFIRA B (05-)
			ZAFIRA C (11-)
		PERODUA	KENARI (00-)
		PEUGEOT	106 I (91-96)
			106 II (96-)
			206 (98-)
			306 (93-02)
		PLYMOUTH	BREEZE (95-01)
		PUCH	G-MODELL (W463)
		RENAULT	TWINGO I (93-)
		SAAB	9-3 (02-)
		SEAT	CORDOBA (6L) (0
			IBIZA IV (6L) (
		SKODA	FABIA (6Y) (99-
			FABIA (06-14)
			FELICIA Fun (97
			FELICIA II (6U)
			ROOMSTER (5J) (
		SUBARU	FORESTER (97-02
			FORESTER (02-)
			IMPREZA (00-)
			LEGACY III (98-
			OUTBACK (00-03)
			VIVIO (92-98)
		SUZUKI	WAGON R (03-05)
		TOYOTA	4 RUNNER (N10)
			ALLION I (01-07
			AURIS (06-)
			AVENSIS (97-03)
			AVENSIS (03-09)
			bB (00-05)
			CALDINA (92-97)
			CALDINA (97-01)
			CARINA E (92-97
			CELICA (99-05)
			COROLLA (E9) (8
			COROLLA (E10) (
			COROLLA (E11) (
			COROLLA (E12) (
			COROLLA (E14, E
			COROLLA Verso (
			CORONA (87-92)
			CORSA (94-99)
			ECHO (99-05)
			HILUX II (83-05
			IST (04-07)
			LAND CRUISER (J
			LAND CRUISER
			LAND CRUISER
			MR 2 III (99-07
			PASEO (95-99)
			PLATZ (99-05)
			PORTE I (04-12)
			PREVIA I (90-00
			PROBOX
			RAUM (03-)
			RAV 4 II (00-05
			STARLET (P9) (9
			SUPRA (93-02)
			TERCEL (94-99)
			TUNDRA (99-06)
			URBAN CRUISER (
			VIOS
			WILL Cypha (01-
			WILL VS (01-04)
			WISH (03-09)
			YARIS (99-05)
			YARIS (05-)

DENSO P/N	TT	MAKE	MODEL
K16TT	-		YARIS (10-)
<i>continued</i>			YARIS VERSO (99)
		UAZ	HUNTER (04-) PATRIOT (04-)
		VAUXHALL	AGILA I (A) (00) ASTRA IV (G) (9) ASTRA V (H) (04) COMBO II (C) (0) CORSA II (C) (0) CORSA III (D) () FRONTERA II (B) INSIGNIA (08-) MERIVA I (A) (0) MOKKA (12-) SIGNUM (02-08) TIGRA TwinTop () VECTRA II (C) () ZAFIRA II (B) () ZAFIRA III (C)
		VW	FOX (5Z) (03-) NEW BEETLE (9C, POLO (9N) (01-0 TRANSPORTER IV VENTO (1H2) (91
		ZASTAVA	10 (05-)
K20BR-S10	K20TT	DAIHATSU	SIRION (98-05) YRV (01-)
		RENAULT	CLIO I (90-98)
		VW	PASSAT (3A2, 35
K20HR-U11	KH20TT	CITROËN	C4 (Grand) Pica C4 I (LC) (04-) C5 I (01-04) C5 II (04-) C5 III (08-) C8 (02-) JUMPY (95-) JUMPY (07-) XSARA Picasso ()
		FIAT	ULYSSE (02-11)
		LANCIA	PHEDRA (02-10) ZETA (95-02)
		MITSUBISHI	COLT CZC (06-09) COLT VI (04-)
		NISSAN	ALMERA II (00-) PRIMERA (02-) X-TRAIL (01-)
		PEUGEOT	206 (98-) 207 (06-) 307 (00-) 308 I (07-)
		SMART	FORFOUR (454) ()
		TOYOTA	4 RUNNER (N18) FJ CRUISER (07- LAND CRUISER TUNDRA (99-06)
		VOLVO	C30 (06-12) C70 II (06-) S40 II (04-) V50 (04-)
K20PBR	K20TT	ALFA ROMEO	33 (90-94) 75 (85-92) 164 (87-98)
		CITROËN	XM (89-94) XM (94-00)
		FIAT	PUNTO (93-00)
		LANCIA	DELTA II (93-99)
		OPEL	SIGNUM (03-) VECTRA C (02-) ZAFIRA B (05-)
		PEUGEOT	405 II (92-99) 605 (89-99)

DENSO P/N	TT	MAKE	MODEL
K20PBR	K20TT	RENAULT	19 II (92-01) 21 (86-95) 25 (84-93) LAGUNA I (93-01) MEGANE I (96-03) SAFRANE I (92-9 SAFRANE II (96- SPORT Spider (9
<i>continued</i>		SEAT	TOLEDO I (1L) ()
		VAUXHALL	SIGNUM (02-08) VECTRA II (C) () ZAFIRA II (B) ()
		VOLVO	S40 I (95-03) V40 (95-04)
		VW	CORRADO (53I) ()
K20PBR-S10	K20TT	ALFA ROMEO	147 (00-10) 156 (97-06)
		AUDI	80 (8C, B4) (91 100 (4A, C4) (9 A2 (8Z) (00-05) A3 (8L) (96-03) A3 (8P) (03-13) A3 Convertible A4 (8D, B5) (94 A4 (8E, B6) (00 A4 (8E, B7) (04 A4 Convertible A6 (4A, C4) (94 A6 (4B, C5) (97 A6 (4F, C6) (04 A8 (4D) (94-02) A8 (4E) (02-10) ALLROAD (4BH) () CABRIOLET (8G7) COUPE (89, 8B) TT (8N) (98-06)
		CADILLAC	CTS (02-07)
		CHEVROLET	EPICA (05-) LACETTI (05-)
		DAIHATSU	SIRION (98-05) TERIOS (97-) TERIOS (05-) YRV (01-)
		FIAT	COUPE (93-00)
		LANCIA	THESIS (02-09)
		MERCEDES-BENZ	A-CLASS (W168) C-CLASS (202) () CLK (208) (97-0 E-CLASS (210) () M-CLASS (W163) SLK (R170) (96- SPRINTER 2-t (9 SPRINTER 3-t (9 SPRINTER 4-t (9 Vaneo (414) (02 V-CLASS (638) VITO (638) (96-
		OPEL	CORSA B (93-00)
		PORSCHE	BOXSTER (986) () CAYENNE (955) ()
		RENAULT	19 I (88-92) 19 II (92-01) CLIO I (90-98) LAGUNA I (93-01) SAFRANE I (92-9 SAFRANE II (96-
		SEAT	ALHAMBRA (7V) () ALTEA (XL) (5P) AROSA (6H) (97- CORDOBA (6K1) () CORDOBA (6K2) ()

DENSO P/N	TT	MAKE	MODEL
K20PBR-S10	K20TT		CORDOBA (6L) (0)
<i>continued</i>			EXEO (3R) (08-)
			IBIZA II (6K1)
			IBIZA III (6K2)
			IBIZA IV (6L) (
			IBIZA V (6J) (0
			INCA (6K9) (95-
			LEON (1M) (99-0
			LEON (1P) (05-)
			TOLEDO I (1L) (
			TOLEDO II (1M)
			TOLEDO III (5P)
		SKODA	FABIA (6Y) (99-
			OCTAVIA (1U) (9
			OCTAVIA (1Z) (0
			SUPERB (3U) (01
		VOLVO	850 (91-97)
			C70 I (97-05)
			S60 I (00-10)
			S70 (96-00)
			S80 I (98-06)
			V70 I (96-00)
			V90 (96-98)
		VW	BORA (1J) (98-0
			CADDY II (9K, 9
			CADDY III (2K,
			GOLF III (1H, 1
			GOLF IV (1J, 1E
			GOLF PLUS (5M,
			GOLF V (1K) (03
			GOLF VI (5K, 51
			JETTA III (1K2)
			LUPO (6X, 6E) (
			MULTIVAN V (7H,
			NEW BEETLE (9C,
			PASSAT (3A2, 35
			PASSAT (3B2, 3B
			PASSAT (3B3, 3B
			PASSAT (3C) (05
			PHAETON (3D) (0
			POLO (6N1) (94-
			POLO (6N2) (99-
			POLO (9N) (01-0
			POLO Classic (6
			POLO Saloon (9A
			POLO Variant (6
			SHARAN (7M) (95
			TOUAREG (7L) (0
			TOURAN (1T1, 1T
			TRANSPORTER V (
			VENTO (1H2) (91
K20PR-L11	K20TT	HONDA	CIVIC IV (87-95
			CIVIC V (91-97)
			CIVIC VI (94-01
			CRX II (87-92)
			CRX III (92-98)
K20PR-U	K20TT	AUDI	A3 (8P) (03-13)
		AUSTIN	MAESTRO (83-92)
			MONTEGO (84-92)
		AUTOBIANCHI	Y10 (85-95)
		CATERHAM	21 (94-)
			SUPER SEVEN (80
		CHERY	EASTAR CROSS (0
			QIYUN (03-10)
			QQ6 (06-)
			TIGGO 3 (07-)
			TIGGO (05-08)
			TIGGO (10-)
			X1 (10-)
		CHRYSLER	CIRRUS (94-00)
			NEON (94-99)

DENSO P/N	TT	MAKE	MODEL
K20PR-U	K20TT		NEON (99-)
<i>continued</i>			STRATUS (95-01)
			VOYAGER (95-01)
		CITROËN	AX (86-98)
			BERLINGO (B9) (
			BERLINGO (MF) (
			BX (82-94)
			C2 (03-)
			C3 I (02-)
			C3 II (09-)
			C3 Pluriel (03-
			C15 (84-05)
			EVASION (94-02)
			JUMPER (94-02)
			JUMPER (02-)
			NEMO (08-)
			SAXO (96-04)
			XANTIA (93-98)
			XANTIA (98-03)
			XM (94-00)
			XSARA (97-05)
			ZX (91-98)
		DACIA	DUSTER (10-)
			LOGDY (12-)
			LOGAN I (04-)
			LOGAN MCV I (07
			SANDERO I (08-)
			SOLENZA (03-)
			SUPERNOVA (00-0
		DODGE	CARAVAN (95-02)
			NEON (94-99)
			NEON (99-)
			STRATUS (95-01)
		DR	DR 1 (10-)
			DR 2 (10-)
			DR 5 (11-)
		FIAT	DUCATO (94-02)
			DUCATO (02-)
			FIORINO (07-)
			PALIO (96-)
			PUNTO (93-00)
			QUBO (08-)
			STILO (01-08)
			ULYSSE (94-02)
			UNO (83-00)
		FORD	ESCORT II (73-8
			ESCORT IV (85-9
			FIESTA III (89-
			ORION III (90-9
			SCORPIO I (85-9
			TRANSIT (94-00)
			TRANSIT TOURNEO
		FSO	POLONEZ III (92
		GEELY	CK (05-)
		HYUNDAI	ACCENT II (99-0
			ACCENT III (05-
			S COUPE (90-96)
		INNOCENTI	ELBA (91-96)
		JAGUAR	XJ (86-94)
			XJ (94-97)
			XJ Coupe (73-96
		JEEP	CHEROKEE (84-01
		KIA	CARENS I (00-02
			RIO I (00-05)
			SHUMA I (96-01)
			SHUMA II (01-04
		LADA	110 (95-)
			LARGUS (12-)
		LANCIA	Y (95-03)
			ZETA (95-02)
		LAND ROVER	DISCOVERY I (89

Spark & Glow Plugs

Buyers Guide

DENSO P/N	TT	MAKE	MODEL
K20PR-U	K20TT	LOTUS	ELAN (89-95)
<i>continued</i>		MAZDA	323 C IV (89-00)
			323 F IV (87-94)
			626 II (82-87)
			626 III (87-97)
			929 II (82-87)
		MITSUBISHI	SPACE RUNNER (9
			SPACE WAGON (91
		NISSAN	ALMERA I (95-00)
			PRIMERA (90-98)
			PRIMERA (96-02)
			SUNNY III (90-0
		OPEL	KADETT E (84-94
		PANTHER	KALLISTA (82-93
		PEUGEOT	106 I (91-96)
			205 I (83-94)
			205 II (87-98)
			206 (98-)
			206+ (09-)
			207 (06-)
			306 (93-02)
			307 (00-)
			309 I (85-89)
			309 II (89-93)
			405 I (87-93)
			405 II (92-99)
			604 (77-87)
			1007 (05-)
			BIPPER (08-)
			BOXER (02-)
			PARTNER
		PLYMOUTH	BREEZE (95-01)
			NEON (94-)
		RENAULT	19 II (92-01)
			CLIO I (90-98)
			CLIO II (98-)
			CLIO III (05-)
			DUSTER (09-)
			ESPACE III (96-
			FLUENCE (10-)
			GRAND SCÉNIC II
			GRAND SCÉNIC II
			KANGOO (97-)
			KANGOO (08-)
			LAGUNA I (93-01
			LAGUNA II (01-)
			LAGUNA III (07-
			LOGAN I (04-)
			MEGANE I (96-03
			MEGANE II (02-)
			MEGANE III (08-
			MODUS (04-)
			RAPID (85-98)
			SAFRANE II (96-
			SANDERO (Stepwa
			SCÉNIC I (99-03
			SCÉNIC II (03-)
			SCÉNIC III (09-
			THALIA I (98-)
			THALIA II (08-)
		ROVER	100
			200 (RF) (95-00
			200 (XH) (85-89
			200 (XW) (89-99
			400 (90-98)
			800 (86-99)
			CABRIOLET (90-9
			COUPE (96-99)
			MAESTRO (90-95)
		SEAT	ALTEA (XL) (5P)
			LEON (1P) (05-)

DENSO P/N	TT	MAKE	MODEL
K20PR-U	K20TT		TOLEDO III (5P)
<i>continued</i>		SKODA	FAVORIT (78) (8
			FELICIA I (6U)
			OCTAVIA (1Z) (0
		SUZUKI	ALTO III (93-02
			BALENO (95-02)
			CARRY (99-)
			JIMNY (98-)
			VITARA (88-99)
			X-90 (95-97)
		TATA	INDICA (98-)
		TRIUMPH	ACCLAIM (82-85)
		VAUXHALL	ASTRA II (84-94
		VOLVO	S90 (96-98)
			V70 II (00-07)
			V90 (96-98)
		VW	EOS (1F) (06-)
			GOLF PLUS (5M,
			GOLF V (1K) (03
			JETTA III (1K2)
			PASSAT (3C) (05
			TOURAN (1T1, 1T
K20PR-U11	K20TT	BYD	F3 (05-)
			F3R (07-)
		CHEVROLET	AVEO (T250, T25
			CRUZE (00-08)
			CRUZE (09-)
			KALOS (05-)
			LACETTI (05-)
			LANOS (05-)
			NUBIRA (05-)
			OPTRA (03-08)
			REZZO (05-)
		DAEWOO	CIELO (94-98)
			ESPERO (91-99)
			GENTRA (02-05)
			GENTRA (05-)
			KALOS (02-)
			LACETTI (97-99)
			LANOS (97-)
			NEXIA (95-08)
			NEXIA (08-)
			NUBIRA (97-)
			NUBIRA (03-)
			TACUMA
		DAIHATSU	APPLAUSE I (89-
			CHARADE III (87
			CHARADE IV (93-
			FEROZA (88-99)
			GRAN MOVE (96-)
			HJET (98-)
		FORD	ESCORT VII (95-
		FSO	LANOS (04-08)
		GREAT WALL	HOVER H5 (10-)
		HONDA	CITY (99-04)
			CITY (03-)
			CIVIC IV (87-95
			CIVIC V (91-97)
			CIVIC VI (94-01
			JAZZ II (02-08)
			JAZZ Saloon (03
		HYUNDAI	ACCENT I (94-00
			LANTRA II (95-0
		ISUZU	GEMINI (88-90)
			TROOPER (91-98)
		KIA	CARENS II (02-)
			CLARUS (96-)
			SPORTAGE I (94-
		MAZDA	323 C IV (89-00
			323 F IV (87-94
			323 F V (94-98)

DENSO P/N	TT	MAKE	MODEL
K20PR-U11	K20TT		323 F VI (98-04)
<i>continued</i>			323 P V (96-)
			323 S IV (89-94)
			323 S V (94-98)
			323 S VI (98-04)
			626 III (87-97)
			626 IV (91-97)
			E-SERIE (SR) (8)
			MX-5 I (90-98)
			MX-5 II (98-05)
			XEDOS 6 (92-99)
		MERCEDES-BENZ	A-CLASS (W169)
			B-CLASS (W245)
		MITSUBISHI	CARISMA (95-06)
			COLT IV (92-96)
			COLT V (95-03)
			GALANT V (92-96)
			GALANT VI (96-0)
			LANCER III (83-)
			LANCER IV (88-9)
			LANCER V (91-03)
			LANCER VI (95-0)
			LANCER VII (03-)
			SPACE RUNNER (9)
			SPACE STAR (98-)
			SPACE WAGON (91)
			SPACE WAGON (98)
		NISSAN	ALMERA II (00-)
		PROTON	AEROBACK (88-96)
			IMPIAN (01-)
			PERSONA 300 (96)
			PERSONA 400 (94)
			WIRA (00-)
		ROVER	400 (95-00)
		SUBARU	FORESTER (97-02)
			IMPREZA (92-00)
			IMPREZA (00-)
			LEGACY I (89-94)
			LEGACY II (94-9)
			REX III (89-92)
			VIVIO (92-98)
		SUZUKI	BALENO (95-02)
			GRAND VITARA (9)
			GRAND VITARA (0)
			IGNIS I (00-03)
			LIANA (01-)
			WAGON R+ (00-)
		VAUXHALL	MONTREY I (91-)
		ZAZ	LANOS (04-)
K20PSR-B8	IK20TT	MITSUBISHI	ASX (10-)
			LANCER (07-)
			OUTLANDER III (
K20P-U	K20TT	SUZUKI	SWIFT II (89-05)
			WAGON R (03-05)
K20R-U	K20TT	ALPINA	B12 (E31) (90-9)
		CHRYSLER	PT CRUISER (00-)
		HOLDEN	NOVA (91-94)
			NOVA (94-97)
		INFINITI	G20 (90-97)
		LEXUS	LX (98-08)
		MITSUOKA	LA SEYDE (00-04)
		NISSAN	200 SX (93-99)
			PRIMASTAR (01-)
			PRIMERA (90-98)
			PRIMERA (96-02)
			SERENA (92-01)
			TERRANO I (87-9)
		OPEL	VECTRA A (88-95)
		TOYOTA	AVENSIS (97-03)
			CARINA E (92-97)
			CELICA (93-99)

DENSO P/N	TT	MAKE	MODEL
K20R-U	K20TT		COROLLA (E10) (
<i>continued</i>			COROLLA (E11) (
			CRESSIDA (92-96)
			LAND CRUISER (J
			MR 2 II (89-00)
			SEQUOIA (00-)
			SUPRA (93-02)
		VAUXHALL	CAVALIER III (8
K20R-U11	K20TT	DAIHATSU	COPEN (03-)
			SIRION (05-)
		FAW	V2 (13-)
		LOTUS	ELISE (00-)
		NISSAN	ALMERA I (95-00)
			PRIMERA (96-02)
		PERODUA	MYVI (06-11)
		TOYOTA	CAMRY (83-88)
			CARINA E (92-97)
			HARRIER (98-03)
			PREVIA II (00-0
			RAV 4 I
			RAV 4 II (00-05
			YARIS (99-05)
K20TNR	K20TT	CITROËN	SAXO (96-04)
			XSARA (97-05)
		FIAT	BARCETTA (95-0
			BRAVA (95-02)
			BRAVO I (95-01)
			CINQUECENTO (91
			COUPE (93-00)
			DOBLO (01-)
			MAREA (96-07)
			MULTIPLA (99-10
			PALIO (96-)
			PANDA (80-04)
			PUNTO (99-)
			SEICENTO (98-10
			STILO (01-08)
			STRADA (99-)
		LANCIA	DEDRA (89-99)
			DELTA II (93-99
			KAPPA (94-01)
			LYBRA (99-05)
			THESIS (02-09)
			Y (95-03)
		OPEL	OMEGA B (94-03)
		PEUGEOT	306 (93-02)
		PORSCHE	BOXSTER (986) (
		VAUXHALL	OMEGA (B) (94-0
K20TNR-S	K20TT	DAIHATSU	APPLAUSE I (89-
			APPLAUSE II (97
			CHARADE III (87
			CHARADE IV (93-
			HIJET (92-)
			TERIOS (97-)
		PEUGEOT	106 I (91-96)
			106 II (96-)
		PIAGGIO	PORTER (93-)
		TOYOTA	CAMI (99-05)
K20TNR-S9	K20TT	CITROËN	SAXO (96-04)
		DAIHATSU	MOVE (02-)
			TERIOS (97-)
		LOTUS	ESPRIT S4 (89-0
K20TR11	K20TT	TOYOTA	AVALON (95-05)
			AVENSIS (97-03)
			CAMRY (90-97)
			CAMRY (96-01)
			CAMRY SOLARA (9
			PICNIC (96-01)
			RAV 4 I
			SIENNA (97-03)
			VISTA (98-03)

DENSO P/N	TT	MAKE	MODEL
K20TR11	K20TT		WINDOM (96-01)
<i>continued</i>			
K20TT	-	ALFA ROMEO	33 (90-94) 75 (85-92) 145 147 (00-10) 155 (92-97) 156 (97-06) 159 (05-11) 164 (87-98) 166 (98-07) GT (03-10) GTV (95-05) SPIDER (94-05)
		ALPINA	B3 (E36) (93-99) B3 (E46) (99-06) B8 (E36) (95-98) B10 (E39) (96-0) B12 (E31) (90-9) B12 (E38) (95-0) ROADSTER (Z8) (ROADSTER S (Z4)
		AUDI	80 (8C, B4) (91) 100 (4A, C4) (9 A2 (8Z) (00-05) A3 (8L) (96-03) A3 (8P) (03-13) A3 Convertible A4 (8D, B5) (94 A4 (8E, B6) (00 A4 (8E, B7) (04 A4 Convertible A6 (4A, C4) (94 A6 (4B, C5) (97 A6 (4F, C6) (04 A8 (4D) (94-02) A8 (4E) (02-10) ALLROAD (4BH) (CABRIOLET (8G7) COUPE (89, 8B) TT (8N) (98-06)
		AUSTIN	MAESTRO (83-92) MONTEGO (84-92)
		AUTOBIANCHI	Y10 (85-95)
		BEDFORD	RASCAL (86-90)
		BENTLEY	ARNAGE (98-09)
		BMW	1 (E81, E87) (0 3 (E30) (82-94) 3 (E36) (90-00) 3 (E46) (98-05) 3 (E90, E91) (0 5 (E28) (81-87) 5 (E34) (87-97) 5 (E39) (95-04) 5 (E60, E61) (0 6 (E63, E64) (0 7 (E32) (86-94) 7 (E38) (94-01) 7 (E65, E66) (0 8 (E31) (90-99) X3 (E83) (04-) X5 (E53) (00-) Z3 (E36) (95-03 Z4 (E85, E86) (Z8 (E52) (00-03
		BYD	F3 (05-) F3R (07-)
		CADILLAC	CTS (02-07)
		CATERHAM	21 (94-) SUPER SEVEN (80
		CHERY	EASTAR CROSS (0

DENSO P/N	TT	MAKE	MODEL
K20TT	-		QIYUN (03-10)
<i>continued</i>			QQ6 (06-) TIGGO 3 (07-) TIGGO (05-08) TIGGO (10-) X1 (10-)
		CHEVROLET	AVEO (T250, T25 AVEO (T300) (11 CAPTIVA (06-) CRUZE (00-08) CRUZE (09-) EPICA (05-) EVANDA (05-) KALOS (05-) LACETTI (05-) LANOS (05-) NUBIRA (05-) OPTRA (03-08) ORLANDO (11-) REZZO (05-) TRAX (12-)
		CHRYSLER	CIRRUS (94-00) NEON (94-99) NEON (99-) PT CRUISER (00- STRATUS (95-01) VOYAGER (95-01)
		CITROËN	AX (86-98) BERLINGO (B9) (BERLINGO (MF) (BX (82-94) C2 (03-) C3 I (02-) C3 II (09-) C3 Pluriel (03- C15 (84-05) EVASION (94-02) JUMPER (94-02) JUMPER (02-) NEMO (08-) SAXO (96-04) XANTIA (93-98) XANTIA (98-03) XM (89-94) XM (94-00) XSARA (97-05) ZX (91-98)
		DACIA	DUSTER (10-) LODGY (12-) LOGAN I (04-) LOGAN MCV I (07 SANDERO I (08-) SOLENTA (03-) SUPERNOVA (00-0
		DAEWOO	CIELO (94-98) ESPERO (91-99) EVANDA (02-) GENTRA (02-05) GENTRA (05-) KALOS (02-) LACETTI (97-99) LACETTI (04-) LANOS (97-) LEGANZA (97-04) NEXIA (95-08) NEXIA (08-) NUBIRA (97-) NUBIRA (03-) TACUMA
		DAIHATSU	ALTIS (96-01) APPLAUSE I (89-

DENSO P/N	TT	MAKE	MODEL
K20TT	-		APPLAUSE II (97)
<i>continued</i>			CHARADE III (87)
			CHARADE IV (93-
			COPEN (03-)
			FEROZA (88-99)
			GRAN MOVE (96-)
			HIJET (92-)
			HIJET (98-)
			MOVE (02-)
			SIRION (98-05)
			SIRION (05-)
			TERIOS (97-)
			TERIOS (05-)
			YRV (01-)
		DODGE	CARAVAN (95-02)
			DURANGO (03-10)
			NEON (94-99)
			NEON (99-)
			NITRO (06-)
			RAM (01-08)
			STRATUS (95-01)
		DR	DR 1 (10-)
			DR 2 (10-)
			DR 5 (11-)
		FAW	V2 (13-)
		FIAT	BARCETTA (95-0
			BRAVA (95-02)
			BRAVO I (95-01)
			CINQUECENTO (91
			COUPE (93-00)
			DOBLO (01-)
			DUCATO (94-02)
			DUCATO (02-)
			FIORINO (07-)
			MAREA (96-07)
			MULTIPLA (99-10
			PALIO (96-)
			PANDA (80-04)
			PUNTO (93-00)
			PUNTO (99-)
			QUBO (08-)
			SEICENTO (98-10
			STILO (01-08)
			STRADA (99-)
			ULYSSE (94-02)
			UNO (83-00)
		FORD	ESCORT II (73-8
			ESCORT IV (85-9
			ESCORT VII (95-
			FIESTA III (89-
			GALAXY (95-06)
			ORION III (90-9
			SCORPIO I (85-9
			SCORPIO II (94-
			TRANSIT (94-00)
			TRANSIT (00-06)
			TRANSIT TOURNEO
		FORD USA	PROBE II (93-98
		FSO	LANOS (04-08)
			POLONEZ III (92
		GEELY	CK (05-)
		GREAT WALL	HOVER H5 (10-)
		HOLDEN	APOLLO (JM) (93
			ASTRA G (TS) (9
			ASTRA H (AH) (0
			NOVA (91-94)
			NOVA (94-97)
		HONDA	ACCORD IV (90-9
			ACCORD V (93-98
			ACCORD VI (97-0
			CITY (99-04)

DENSO P/N	TT	MAKE	MODEL
K20TT	-		CITY (03-)
<i>continued</i>			CIVIC IV (87-95
			CIVIC V (91-97)
			CIVIC VI (94-01
			CIVIC VII (00-0
			CIVIC VIII Hatc
			CR-V I (95-02)
			CRX II (87-92)
			CRX III (92-98)
			FR-V (04-)
			JAZZ II (02-08)
			JAZZ Saloon (03
			NSX (90-05)
			PRELUDE IV (92-
			PRELUDE V (96-0
			SHUTTLE (94-04)
			STREAM (01-)
		HYUNDAI	ACCENT I (94-00
			ACCENT II (99-0
			ACCENT III (05-
			LANTRA II (95-0
			S COUPE (90-96)
		INFINITI	G20 (90-97)
		INNOCENTI	ELBA (91-96)
		ISUZU	GEMINI (88-90)
			TROOPER (91-98)
		JAGUAR	XJ (86-94)
			XJ (94-97)
			XJ Coupe (73-96
		JEEP	CHEROKEE
			CHEROKEE (84-01
			CHEROKEE (01-08
			COMMANDER (05-1
			GRAND CHEROKEE
			GRAND CHEROKEE
			GRAND CHEROKEE
		KIA	CARENS I (00-02
			CARENS II (02-)
			CLARUS (96-)
			RIO I (00-05)
			SHUMA I (96-01)
			SHUMA II (01-04
			SPORTAGE I (94-
		LADA	110 (95-)
			LARGUS (12-)
		LANCIA	DEDRA (89-99)
			DELTA II (93-99
			KAPPA (94-01)
			LYBRA (99-05)
			THESIS (02-09)
			Y (95-03)
			ZETA (95-02)
		LAND ROVER	DISCOVERY I (89
			RANGE ROVER III
		LEXUS	GS (93-97)
			GS (97-05)
			LS (89-94)
			LS (94-00)
			LX (98-08)
		LOTUS	ELAN (89-95)
			ELISE (00-)
			ESPRIT S4 (89-0
			EUROPA S (06-)
		MAZDA	323 C IV (89-00
			323 F IV (87-94
			323 F V (94-98)
			323 F VI (98-04
			323 P V (96-)
			323 S IV (89-94
			323 S V (94-98)
			323 S VI (98-04

DENSO P/N	TT	MAKE	MODEL
K20TT	-		626 II (82-87)
<i>continued</i>			626 III (87-97)
			626 IV (91-97)
			929 II (82-87)
			929 III (87-91)
			E-SERIE (SR) (8)
			MX-5 I (90-98)
			MX-5 II (98-05)
			XEDOS 6 (92-99)
			XEDOS 9 (93-02)
		MERCEDES-BENZ	A-CLASS (W168)
			A-CLASS (W169)
			B-CLASS (W245)
			C-CLASS (202) (
			CLK (208) (97-0
			E-CLASS (210) (
			M-CLASS (W163)
			S-CLASS (W140)
			SLK (R170) (96-
			SPRINTER 2-t (9
			SPRINTER 3-t (9
			SPRINTER 4-t (9
			VANEO (414) (02
			V-CLASS (638
			VITO (638) (96-
		MINI	MINI (R50, R53)
			MINI Convertibl
		MITSUBISHI	3000 GT (92-99)
			CARISMA (95-06)
			COLT IV (92-96)
			COLT V (95-03)
			eK (00-)
			GALANT V (92-96
			GALANT VI (96-0
			LANCER III (83-
			LANCER IV (88-9
			LANCER V (91-03
			LANCER VI (95-0
			LANCER VII (03-
			PAJERO I (82-91
			SIGMA (90-96)
			SPACE RUNNER (9
			SPACE STAR (98-
			SPACE WAGON (91
			SPACE WAGON (98
			TOPPO (90-03)
			TOPPO (08-)
		MITSUOKA	LA SEYDE (00-04
		MORGAN	AERO 8 (00-)
		NISSAN	200 SX (93-99)
			ALMERA I (95-00
			ALMERA II (00-)
			CLIPPER Van (03
			MAXIMA QX (95-0
			MAXIMA QX (00-0
			PRIMASTAR (01-)
			PRIMERA (90-98)
			PRIMERA (96-02)
			SERENA (92-01)
			SUNNY III (90-0
			TERRANO I (87-9
		OPEL	ADAM (12-)
			AGILA (00-07)
			ANTARA (06-)
			ASCONA C (81-88
			ASTRA F (91-01)
			ASTRA F CLASSIC
			ASTRA G (98-09)
			ASTRA H (04-)
			ASTRA J (09-)
			CALIBRA (90-97)

DENSO P/N	TT	MAKE	MODEL
K20TT	-		COMBO (94-01)
<i>continued</i>			COMBO (01-)
			CORSA A (82-93)
			CORSA B (93-00)
			CORSA C (00-09)
			CORSA D (06-)
			FRONTERA A (92-
			INSIGNIA (08-)
			KADETT E (84-94
			MERIVA A (03-10
			MERIVA B (10-)
			MOKKA (12-)
			OMEGA A (86-94)
			OMEGA B (94-03)
			SENATOR B (87-9
			SIGNUM (03-)
			SINTRA (96-99)
			SPEEDSTER (00-)
			TIGRA (94-00)
			VECTRA A (88-95
			VECTRA B (95-03
			VECTRA C (02-)
			VIVARO A (01-)
			ZAFIRA A (99-05
			ZAFIRA B (05-)
			ZAFIRA C (11-)
		PANTHER	KALLISTA (82-93
		PERODUA	MYVI (06-11)
		PEUGEOT	106 I (91-96)
			106 II (96-)
			205 I (83-94)
			205 II (87-98)
			206 (98-)
			206+ (09-)
			207 (06-)
			306 (93-02)
			307 (00-)
			309 I (85-89)
			309 II (89-93)
			405 I (87-93)
			405 II (92-99)
			406 (95-04)
			604 (77-87)
			605 (89-99)
			806 (94-02)
			1007 (05-)
			BIPPER (08-)
			BOXER (94-02)
			BOXER (02-)
			PARTNER
		PIAGGIO	PORTER (93-)
		PLYMOUTH	BREEZE (95-01)
			NEON (94-)
		PORSCHE	911 (996) (97-0
			BOXSTER (986) (
			CAYENNE (955) (
		PROTON	AEROBACK (88-96
			IMPIAN (01-)
			PERSONA 300 (96
			PERSONA 400 (94
			WIRA (00-)
		RENAULT	19 I (88-92)
			19 II (92-01)
			21 (86-95)
			25 (84-93)
			CLIO I (90-98)
			CLIO II (98-)
			CLIO III (05-)
			DUSTER (09-)
			ESPACE III (96-
			FLUENCE (10-)

DENSO P/N	TT	MAKE	MODEL
K20TT	-		GRAND SCÉNIC II
<i>continued</i>			GRAND SCÉNIC II
			KANGOO (97-)
			KANGOO (08-)
			LAGUNA I (93-01)
			LAGUNA II (01-)
			LAGUNA III (07-)
			LOGAN I (04-)
			MEGANE I (96-03)
			MEGANE II (02-)
			MEGANE III (08-)
			MEGANE Scénic (
			MODUS (04-)
			RAPID (85-98)
			SAFRANE I (92-9
			SAFRANE II (96-
			SANDERO (Stepwa
			SCÉNIC I (99-03
			SCÉNIC II (03-)
			SCÉNIC III (09-
			SPORT Spider (9
			THALIA I (98-)
			THALIA II (08-)
			TWINGO II (07-)
		ROLLS-ROYCE	PHANTOM (02-)
		ROVER	100
			200 (RF) (95-00
			200 (XH) (85-89
			200 (XW) (89-99
			400 (90-98)
			400 (95-00)
			600 (93-99)
			800 (86-99)
			CABRIOLET (90-9
			COUPE (96-99)
			MAESTRO (90-95)
			STREETWISE (03-
		SAAB	900 II (93-98)
			9000 (84-98)
		SEAT	ALHAMBRA (7V) (
			ALTEA (XL) (5P)
			AROSA (6H) (97-
			CORDOBA (6K1) (
			CORDOBA (6K2) (
			CORDOBA (6L) (0
			EXEO (3R) (08-)
			IBIZA II (6K1)
			IBIZA III (6K2)
			IBIZA IV (6L) (
			IBIZA V (6J) (0
			INCA (6K9) (95-
			LEON (1M) (99-0
			LEON (1P) (05-)
			TOLEDO I (1L) (
			TOLEDO II (1M)
			TOLEDO III (5P)
		SKODA	FABIA (6Y) (99-
			FAVORIT (78) (8
			FELICIA I (6U)
			OCTAVIA (1U) (9
			OCTAVIA (1Z) (0
			SUPERB (3U) (01
		SMART	CABRIO (450) (0
			CITY-Coupe (450
			CROSSBLADE (450
		SUBARU	FORESTER (97-02
			IMPREZA (92-00)
			IMPREZA (00-)
			LEGACY I (89-94
			LEGACY II (94-9
			LEGACY OUTBACK

DENSO P/N	TT	MAKE	MODEL
K20TT	-		REX III (89-92)
<i>continued</i>			SVX (92-97)
			VIVIO (92-98)
		SUZUKI	ALTO III (93-02
			BALENO (95-02)
			CARRY (99-)
			GRAND VITARA (9
			GRAND VITARA (0
			IGNIS I (00-03)
			JIMNY (98-)
			LIANA (01-)
			SWIFT II (89-05
			VITARA (88-99)
			WAGON R (03-05)
			WAGON R+ (00-)
			X-90 (95-97)
		TATA	INDICA (98-)
		TOYOTA	AVALON (95-05)
			AVENSIS (97-03)
			CAMI (99-05)
			CAMRY (83-88)
			CAMRY (90-97)
			CAMRY (96-01)
			CAMRY SOLARA (9
			CAMRY SOLARA (0
			CARINA E (92-97
			CELICA (89-93)
			CELICA (93-99)
			CHASER (96-01)
			COROLLA (E10) (
			COROLLA (E11) (
			CRESSIDA (92-96
			CURREN (89-94)
			CURREN (93-98)
			HARRIER (98-03)
			LAND CRUISER (J
			MAJESTA (99-03)
			MARK II (80-01)
			MR 2 II (89-00)
			PICNIC (96-01)
			PREVIA II (00-0
			RAV 4 I
			RAV 4 II (00-05
			SCEPTER (92-96)
			SEQUOIA (00-)
			SIENNA (97-03)
			SOARER (90-00)
			SUPRA (93-02)
			VISTA (90-98)
			VISTA (98-03)
			WINDOM (96-01)
			YARIS (99-05)
		TRIUMPH	ACCLAIM (82-85)
		TVR	CERBERA (96-03)
		VAUXHALL	ADAM (12-)
			AGILA I (A) (00
			ANTARA (06-)
			ASTRA II (84-94
			ASTRA III (F) (
			ASTRA IV (G) (9
			ASTRA V (H) (04
			ASTRA VI (J) (0
			CALIBRA (90-97)
			CARLTON III (86
			CAVALIER III (8
			COMBO I (B) (94
			COMBO II (C) (0
			CORSA I (B) (93
			CORSA II (C) (0
			CORSA III (D) (
			FRONTERA I (A)

Spark & Glow Plugs

Buyers Guide

DENSO P/N	TT	MAKE	MODEL
K20TT	-		INSIGNIA (08-)
<i>continued</i>			MERIVA I (A) (0
			MERIVA II (B) (
			MONTEREY I (91-
			OMEGA (B) (94-0
			SENATOR II (B)
			SIGNUM (02-08)
			SINTRA (96-99)
			SPEEDSTER (VX22
			TIGRA (94-00)
			VECTRA I (B) (9
			VECTRA II (C) (
			ZAFIRA I (A) (9
			ZAFIRA II (B) (
			ZAFIRA III (C)
		VOLVO	850 (91-97)
			960 I (90-94)
			960 II (94-96)
			C70 I (97-05)
			S40 I (95-03)
			S60 I (00-10)
			S70 (96-00)
			S80 I (98-06)
			S90 (96-98)
			V40 (95-04)
			V70 I (96-00)
			V70 II (00-07)
			V90 (96-98)
		VW	BORA (1J) (98-0
			CADDY II (9K, 9
			CADDY III (2K,
			CORRADO (53I) (
			EOS (1F) (06-)
			GOLF III (1H, 1
			GOLF IV (1J, 1E
			GOLF PLUS (5M,
			GOLF V (1K) (03
			GOLF VI (5K, 51
			JETTA III (1K2)
			LUPO (6X, 6E) (
			MULTIVAN V (7H,
			NEW BEETLE (9C,
			PASSAT (3A2, 35
			PASSAT (3B2, 3B
			PASSAT (3B3, 3B
			PASSAT (3C) (05
			PHAETON (3D) (0
			POLO (6N1) (94-
			POLO (6N2) (99-
			POLO (9N) (01-0
			POLO Classic (6
			POLO Saloon (9A
			POLO Variant (6
			SHARAN (7M) (95
			TOUAREG (7L) (0
			TOURAN (1T1, 1T
			TRANSPORTER IV
			TRANSPORTER V (
			VENTO (1H2) (91
		WIESMANN	MF3 Roadster (9
		ZAZ	LANOS (04-)
K20TXR	K20TT	ALPINA	B3 (E36) (93-99
			B3 (E46) (99-06
			B8 (E36) (95-98
			B10 (E39) (96-0
			B12 (E38) (95-0
			ROADSTER (Z8) (
			ROADSTER S (Z4
		AUDI	A4 (8D, B5) (94
			A4 (8E, B6) (00
			A4 (8E, B7) (04

DENSO P/N	TT	MAKE	MODEL
K20TXR	K20TT		A4 Convertible
<i>continued</i>			A6 (4A, C4) (94
			A6 (4B, C5) (97
			A8 (4D) (94-02)
			A8 (4E) (02-10)
		BEDFORD	RASCAL (86-90)
		BENTLEY	ARNAGE (98-09)
		BMW	1 (E81, E87) (0
			3 (E30) (82-94)
			3 (E36) (90-00)
			3 (E46) (98-05)
			3 (E90, E91) (0
			5 (E28) (81-87)
			5 (E34) (87-97)
			5 (E39) (95-04)
			5 (E60, E61) (0
			6 (E63, E64) (0
			7 (E32) (86-94)
			7 (E38) (94-01)
			7 (E65, E66) (0
			8 (E31) (90-99)
			X3 (E83) (04-)
			X5 (E53) (00-)
			Z3 (E36) (95-03
			Z4 (E85, E86) (
			Z8 (E52) (00-03
		CHEVROLET	CAPTIVA (06-)
			EVANDA (05-)
			LACETTI (05-)
			NUBIRA (05-)
			OPTRA (03-08)
			REZZO (05-)
		CITROËN	AX (86-98)
			BERLINGO (MF) (
			BX (82-94)
			C15 (84-05)
			EVASION (94-02)
			JUMPER (94-02)
			SAXO (96-04)
			XANTIA (93-98)
			XANTIA (98-03)
			XM (94-00)
			XSARA (97-05)
			ZX (91-98)
		DACIA	LOGAN I (04-)
			LOGAN MCV I (07
			SANDERO I (08-)
		DAEWOO	EVANDA (02-)
			LACETTI (04-)
			LEGANZA (97-04)
			NUBIRA (97-)
			NUBIRA (03-)
			TACUMA
		FIAT	ULYSSE (94-02)
		FORD	GALAXY (95-06)
		HOLDEN	ASTRA G (TS) (9
		LANCIA	ZETA (95-02)
		LAND ROVER	RANGE ROVER III
		MERCEDES-BENZ	C-CLASS (202) (
			CLK (208) (97-0
			E-CLASS (210) (
			V-CLASS (638
		MINI	MINI (R50, R53)
			MINI Convertibl
		MORGAN	AERO 8 (00-)
		OPEL	AGILA (00-07)
			ANTARA (06-)
			ASCONA C (81-88
			ASTRA F (91-01)
			ASTRA F CLASSIC
			ASTRA G (98-09)

DENSO P/N	TT	MAKE	MODEL
K20TXR	K20TT		CALIBRA (90-97)
<i>continued</i>			COMBO (94-01)
			COMBO (01-)
			CORSA A (82-93)
			CORSA B (93-00)
			CORSA C (00-09)
			FRONTERA A (92-
			MERIVA A (03-10
			OMEGA A (86-94)
			OMEGA B (94-03)
			SENATOR B (87-9
			SIGNUM (03-)
			SINTRA (96-99)
			SPEEDSTER (00-)
			TIGRA (94-00)
			VECTRA A (88-95
			VECTRA B (95-03
			VECTRA C (02-)
			VIVARO A (01-)
			ZAFIRA A (99-05
		PEUGEOT	106 I (91-96)
			106 II (96-)
			205 II (87-98)
			306 (93-02)
			405 II (92-99)
			406 (95-04)
			605 (89-99)
			806 (94-02)
			BOXER (94-02)
			PARTNER
		PORSCHE	911 (996) (97-0
		RENAULT	CLIO II (98-)
			ESPACE III (96-
			KANGOO (97-)
			LAGUNA I (93-01
			MEGANE I (96-03
			MEGANE Scénic (
			SANDERO (Stepwa
			SCÉNIC I (99-03
			THALIA I (98-)
			TWINGO II (07-)
		ROLLS-ROYCE	PHANTOM (02-)
		SAAB	900 II (93-98)
			9000 (84-98)
		SEAT	TOLEDO II (1M)
		SKODA	SUPERB (3U) (01
		SMART	CABRIO (450) (0
			CITY-Coupe (450
			CROSSBLADE (450
		TVR	CERBERA (96-03)
		VAUXHALL	AGILA I (A) (00
			ANTARA (06-)
			ASTRA III (F) (
			ASTRA IV (G) (9
			ASTRA V (H) (04
			CALIBRA (90-97)
			CARLTON III (86
			CAVALIER III (8
			COMBO I (B) (94
			COMBO II (C) (0
			CORSA I (B) (93
			CORSA II (C) (0
			FRONTERA I (A)
			MERIVA I (A) (0
			OMEGA (B) (94-0
			SENATOR II (B)
			SIGNUM (02-08)
			SINTRA (96-99)
			SPEEDSTER (VX22
			TIGRA (94-00)
			VECTRA I (B) (9

DENSO P/N	TT	MAKE	MODEL
K20TXR	K20TT		ZAFIRA I (A) (9
<i>continued</i>		VOLVO	850 (91-97)
			960 I (90-94)
			960 II (94-96)
			V70 I (96-00)
			V70 II (00-07)
		VW	BORA (1J) (98-0
			CORRADO (53I) (
			GOLF III (1H, 1
			GOLF IV (1J, 1E
			PASSAT (3A2, 35
			PASSAT (3B2, 3B
			PASSAT (3B3, 3B
			SHARAN (7M) (95
			TRANSPORTER IV
			VENTO (1H2) (91
		WIESMANN	MF3 Roadster (9
K22PB	-	ALPINE	A610 (91-95)
		AUDI	90 (89, 8A, B3)
			COUPE (89, 8B)
		SEAT	TOLEDO I (1L) (
K22PBR-S	-	AUDI	80 (89, 8A, B3)
			80 (8C, B4) (91
			90 (89, 8A, B3)
			100 (4A, C4) (9
			A6 (4A, C4) (94
			CABRIOLET (8G7)
			COUPE (89, 8B)
		CITROËN	AX (86-98)
			BX (82-94)
			XM (89-94)
		FIAT	PUNTO (93-00)
			UNO (83-00)
		LANCIA	DEDRA (89-99)
			DELTA II (93-99
			THEMA (84-94)
		PEUGEOT	106 I (91-96)
			205 II (87-98)
			309 II (89-93)
			405 I (87-93)
		PORSCHE	911 (964) (88-9
			911 (993) (93-9
			911 (997) (04-1
		RENAULT	SAFRANE I (92-9
		SEAT	CORDOBA (6K1) (
			IBIZA II (6K1)
		VW	CORRADO (53I) (
			GOLF II (19, 1G
			JETTA II (19, 1
			PASSAT (3A2, 35
			SCIROCCO (53B)
K22PR-U	-	FIAT	PALIO (96-)
		JAGUAR	XJ (94-97)
		SAAB	900 I (78-94)
		VOLVO	850 (91-97)
K22PR-U11	-	SAAB	9-3 (02-)
			9-5 (97-)
K22TNR-S	-	PORSCHE	911 (993) (93-9
			911 (996) (97-0
KH16TT	-	CITROËN	BERLINGO (B9) (
			BERLINGO (MF) (
			C1 I (05-)
			C2 (03-)
			C3 I (02-)
			C3 Pluriel (03-
			C4 (Grand) Pica
			C4 Coupe (04-)
			C4 I (LC) (04-)
			C4 II (B7) (09-
			C5 I (01-04)
			C5 II (04-)

Spark & Glow Plugs

Buyers Guide

DENSO P/N	TT	MAKE	MODEL
KH16TT	-		C5 III (08-)
<i>continued</i>			C8 (02-)
			C-ELYSEE (12-)
			EVASION (94-02)
			JUMPY (95-)
			XSARA (97-05)
			XSARA Picasso (
		FIAT	SCUDO (96-06)
			ULYSSE (94-02)
		HYUNDAI	ix35 (09-)
			SANTA FÉ II (06
			SONATA V (05-)
			SONATA VI (09-)
		KIA	MAGENTIS (05-)
			OPTIMA (11-)
			SORENTO II (09-
			SPORTAGE III (1
		MITSUBISHI	COLT VI (04-)
		NISSAN	ALMERA II (00-)
			ALMERA TINO (00
			CUBE (03-05)
			MICRA III (03-1
			PRIMERA (96-02)
			PRIMERA (02-)
			X-TRAIL (01-)
			X-TRAIL (07-)
		PEUGEOT	107 (05-)
			206 (98-)
			206 CC (00-)
			206+ (09-)
			207 (06-)
			307 (00-)
			406 (95-04)
			407 (04-)
			607 (00-)
			806 (94-02)
			807 (02-)
			1007 (05-)
			EXPERT (96-)
			EXPERT (07-)
			PARTNER
			PARTNER
		RENAULT	LAGUNA II (01-)
			MEGANE I (96-03
		SUZUKI	GRAND VITARA (0
			SX4 (06-)
		TOYOTA	AYGO (05-)
			VIOS
			YARIS (05-)
KH20TT	-	CITROËN	C4 (Grand Pica
			C4 I (LC) (04-)
			C5 I (01-04)
			C5 II (04-)
			C5 III (08-)
			C8 (02-)
			JUMPY (95-)
			JUMPY (07-)
			XSARA Picasso (
		FIAT	ULYSSE (02-11)
		LANCIA	PHEDRA (02-10)
			ZETA (95-02)
		MITSUBISHI	COLT CZC (06-09
			COLT VI (04-)
		NISSAN	ALMERA II (00-)
			PRIMERA (02-)
			X-TRAIL (01-)
		PEUGEOT	206 (98-)
			207 (06-)
			307 (00-)
			308 I (07-)
		SMART	FORFOUR (454) (

DENSO P/N	TT	MAKE	MODEL
KH20TT	-	TOYOTA	4 RUNNER (N18)
<i>continued</i>			FJ CRUISER (07-
			LAND CRUISER
			TUNDRA (99-06)
		VOLVO	C30 (06-12)
			C70 II (06-)
			S40 II (04-)
			V50 (04-)
KJ14CR-L11	-	BMW	7 (E38) (94-01)
			8 (E31) (90-99)
		ROLLS-ROYCE	SILVER Seraph (
KJ16CR11	K16TT	MAZDA	323 S VI (98-04
			626 III (87-97)
			626 IV (91-97)
			929 III (87-91)
			B-SERIE (85-99)
			MPV I (95-99)
KJ16CR-L11	K16TT	ALFA ROMEO	159 (05-11)
		BMW	8 (E31) (90-99)
		CADILLAC	BLS (06-)
		CHEVROLET	AVEO (T300) (11
			CRUZE (09-)
			NIVA (2121) (02
			VIVA (03-08)
		FIAT	CROMA (05-)
		HOLDEN	ASTRA G (TS) (9
			ASTRA H (AH) (0
		HONDA	ACCORD VI (97-0
			CAPA (98-02)
			CIVIC V (91-97)
			CIVIC VI (94-01
			CIVIC VII (00-0
			CR-V I (95-02)
			HR-V (99-)
			LOGO (99-02)
			ODYSSEY (02-)
		JEEP	CHEROKEE (84-01
			CJ5 - CJ8 (66-8
			COMANCHE (86-96
			COMMANDER (05-1
			GRAND CHEROKEE
			GRAND CHEROKEE
			WRANGLER I (86-
			WRANGLER II (96
		LOTUS	EUROPA S (06-)
		OPEL	AGILA (00-07)
			ASTRA G (98-09)
			ASTRA H (04-)
			COMBO (01-)
			CORSA C (00-09)
			CORSA D (06-)
			INSIGNIA (08-)
			MERIVA A (03-10
			MOKKA (12-)
			SIGNUM (03-)
			TIGRA TwinTop (
			VECTRA C (02-)
			ZAFIRA A (99-05
			ZAFIRA B (05-)
			ZAFIRA C (11-)
		SAAB	9-3 (02-)
		SEAT	CORDOBA (6L) (0
			IBIZA IV (6L) (
		SKODA	FABIA (6Y) (99-
			FABIA (06-14)
			ROOMSTER (5J) (
			WAGON R (03-05)
		SUZUKI	WAGON R (03-05)
		VAUXHALL	AGILA I (A) (00
			ASTRA IV (G) (9
			ASTRA V (H) (04
			COMBO II (C) (0

DENSO P/N	TT	MAKE	MODEL
KJ16CR-L11	K16TT		CORSA II (C) (0)
<i>continued</i>			CORSA III (D) (
			INSIGNIA (08-)
			MERIVA I (A) (0
			MOKKA (12-)
			SIGNUM (02-08)
			TIGRA TwinTop (
			VECTRA II (C) (
			ZAFIRA II (B) (
			ZAFIRA III (C)
		VW	FOX (5Z) (03-)
			NEW BEETLE (9C,
			POLO (9N) (01-0
KJ16CR-U11	K16TT	CHRYSLER	SEBRING (07-10)
		DODGE	AVENGER (07-)
			CALIBER (06-)
			JOURNEY (08-)
		HONDA	ACCORD VI (97-0
		HYUNDAI	ELANTRA (05-11)
			i30 (07-12)
		JEEP	COMPASS (06-)
			PATRIOT (07-)
		KIA	CEED (06-)
			CERATO (04-)
			PRO CEED (08-)
		MAZDA	323 F VI (98-04
			MPV II (99-06)
			MX-6 (92-97)
			PREMACY (99-05)
			XEDOS 9 (93-02)
KJ20CR11	K20TT	MAZDA	323 S VI (98-04
KJ20CR-L11	K20TT	CHEVROLET	AVEO (T250, T25
			AVEO (T300) (11
			CRUZE (09-)
		DODGE	DURANGO (03-10)
			NITRO (06-)
			RAM (01-08)
		HOLDEN	ASTRA H (AH) (0
		HONDA	ACCORD IV (90-9
			ACCORD V (93-98
			ACCORD VI (97-0
			CIVIC V (91-97)
			CIVIC VII (00-0
			CIVIC VIII Hatc
			FR-V (04-)
			PRELUDE IV (92-
			PRELUDE V (96-0
			SHUTTLE (94-04)
			STREAM (01-)
		JEEP	CHEROKEE
			CHEROKEE (01-08
			COMMANDER (05-1
			GRAND CHEROKEE
			GRAND CHEROKEE
			GRAND CHEROKEE
		LOTUS	EUROPA S (06-)
		OPEL	ADAM (12-)
			ASTRA H (04-)
			ASTRA J (09-)
			CORSA D (06-)
			INSIGNIA (08-)
			MERIVA A (03-10
			MERIVA B (10-)
			MOKKA (12-)
			ZAFIRA A (99-05
			ZAFIRA B (05-)
			ZAFIRA C (11-)
		ROVER	600 (93-99)
			STREETWISE (03-
		VAUXHALL	ADAM (12-)
			ASTRA V (H) (04

DENSO P/N	TT	MAKE	MODEL
KJ20CR-L11	K20TT		ASTRA VI (J) (0
<i>continued</i>			CORSA III (D) (
			INSIGNIA (08-)
			MERIVA II (B) (
			ZAFIRA II (B) (
			ZAFIRA III (C)
KJ20CR-U11	K20TT	CHEVROLET	AVEO (T250, T25
			CRUZE (09-)
			ORLANDO (11-)
			TRAX (12-)
		FORD USA	PROBE II (93-98
		HONDA	ACCORD V (93-98
			CR-V I (95-02)
		MAZDA	323 F VI (98-04
			323 S VI (98-04
			929 III (87-91)
			XEDOS 9 (93-02)
		MITSUBISHI	eK (00-)
			TOPPO (90-03)
			TOPPO (08-)
		NISSAN	CLIPPER Van (03
		OPEL	CALIBRA (90-97)
		VAUXHALL	CALIBRA (90-97)
KJ20DR-M11	IK20TT	HONDA	ACCORD VII (03-
			CR-V II (01-06)
			CR-V III (06-)
			FR-V (04-)
			STREAM (01-)
		MITSUBISHI	NOUERA (02-)
		SEAT	ALTEA (XL) (5P)
			CORDOBA (6L) (0
			IBIZA IV (6L) (
			IBIZA V (6J) (0
			LEON (1P) (05-)
		SKODA	FABIA (6Y) (99-
			FABIA (06-14)
			OCTAVIA (1Z) (0
			RAPID (HN) (12-
			ROOMSTER (5J) (
		VW	CADDY III (2K,
			FOX (5Z) (03-)
			GOLF PLUS (5M,
			GOLF V (1K) (03
			GOLF VI (5K, 51
			JETTA III (1K2)
			JETTA IV (162)
			POLO (6R, 6C) (
			POLO (9N) (01-0
KJ20SR11	IK20TT	HONDA	ACCORD VI (97-0
		SUBARU	IMPREZA (00-)
KJ22CR-L11	-	HONDA	SHUTTLE (94-04)
M22	-	WARTBURG	353 (66-91)
MA16PR-U	-	FORD	TRANSIT (77-86)
MA20PR-U	-	FORD	CAPRI (78-87)
			GRANADA (72-85)
			SCORPIO I (85-9
			SIERRA (82-87)
			SIERRA (87-93)
			TAUNUS (79-82)
			TRANSIT (77-86)
			TRANSIT (85-92)
			TRANSIT (91-94)
		FORD OTOSAN	TAUNUS (89-)
MA20P-U	-	FORD	CAPRI (78-87)
			ESCORT II (73-8
			SCORPIO I (85-9
			SIERRA (82-87)
			SIERRA (87-93)
			TAUNUS (70-76)
			TAUNUS (75-79)
			TAUNUS (79-82)

DENSO P/N	TT	MAKE	MODEL
MA20P-U	-		TRANSIT (77-86)
<i>continued</i>			TRANSIT (85-92)
MW17	-	AUTO UNION	AU 1000 (58-65) DKW F11 (59-66)
P16PR11	W16TT	HYUNDAI	SANTA FÉ I (00- SONATA II (88-9 SONATA III (93- SONATA IV (98-0
		KIA	SORENTO I (02-)
P16R	W20TT	TOYOTA	HIACE III (87-0 HIACE IV (95-) LITEACE (92-97) MODELL F (82-90
P16R13	W20TT	CHRYSLER	VOYAGER (95-01) VOYAGER (00-08)
		DODGE	CARAVAN (95-02)
		PLYMOUTH	VOYAGER (95-01)
P20PR11	W20TT	MITSUBISHI	DEBONAIR (92-97
		VW	CORRADO (53I) (GOLF II (19, 1G PASSAT (3A2, 35
P22PR8	-	MITSUBISHI	CARISMA (95-06) L 300 (86-) LANCER EVO (92-
PK16PR11	K16TT	MERCEDES-BENZ	C-CLASS (202) (CLK (208) (97-0 E-CLASS (210) (G-CLASS (W463) S-CLASS (W140) SL (R129) (89-0
		PUCH	G-MODELL (W463)
		SUBARU	FORESTER (02-) IMPREZA (00-)
PK16PR-L11	IK16TT	CHEVROLET	CAPTIVA (06-)
		CHRYSLER	STRATUS (95-01)
		HOLDEN	JACKAROO RODEO (78-)
		HYUNDAI	COUPE (01-09) GRANDEUR HIGHWAY VAN (00 SANTA FÉ I (00- SONATA IV (98-0 TERRACAN (01-06 TRAJECT (00-08) TUCSON (04-10)
		ISUZU	D-MAX (02-) TROOPER (00-)
		JAGUAR	S-TYPE (99-08) XJ (97-03) XK 8 (96-05)
		KIA	CARNIVAL II (99 MAGENTIS (01-) MAGENTIS (05-) OPIRUS (03-) SORENTO I (02-) SPORTAGE II (04
		LAND ROVER	DISCOVERY II (9 RANGE ROVER II
		MERCEDES-BENZ	C-CLASS (202) (C-CLASS (203) (C-CLASS Coupe (CLK (208) (97-0 CLK (209) (02-1 CLS (C219) (04- E-CLASS (210) (E-CLASS (211) (M-CLASS (W163) M-CLASS (W164) R-CLASS (251) (S-CLASS (W220) S-CLASS Coupe (

DENSO P/N	TT	MAKE	MODEL
PK16PR-L11	IK16TT		SL (R230) (01-1 SLK (R170) (96- VIANO (W639) (0 VITO
<i>continued</i>			
		MG	MG TF (02-09) MG ZR (01-05) MG ZS (01-05) MG ZT (01-05)
		NISSAN	MAXIMA (88-94) MAXIMA QX (00-0 SKYLINE (R33) (FRONTERA B (98- MONTEREY B (98-
		OPEL	
		ROVER	25 (99-05) 45 (00-05) 75 (99-05) 400 (90-98) STREETWISE (03- FORESTER (97-02 FORESTER (02-) LEGACY IV (03-) OUTBACK (03-09)
		SUBARU	
		VAUXHALL	FRONTERA II (B) MONTEREY II (98
PK16PR-P11	K16TT	MITSUBISHI	MAGNA (96-05) PAJERO II (90-0 PAJERO III (00- PAJERO Sport I
PK16R11	K16TT	MITSUBISHI	RYOGA (99-)
		TOYOTA	PASEO (95-99) PREVIA I (90-00
PK16R8	IK16TT	TOYOTA	PASEO (95-99)
PK16TR11	K16TT	TOYOTA	SUPRA (93-02)
PK16TR13	IK16TT	TOYOTA	CALDINA (92-97) CALDINA (97-01)
PK20GR8	-	TOYOTA	NADIA (98-03) VISTA (98-03)
PK20PR11	K20TT	FORD	SCORPIO I (85-9 SCORPIO II (94- TRANSIT (00-06) NSX (90-05)
		HONDA	
		MERCEDES-BENZ	C-CLASS (202) (S-CLASS (W140) SPRINTER 2-t (9 SPRINTER 4-t (9
		MITSUBISHI	GALANT VI (96-0
		NISSAN	MAXIMA QX (95-0 MAXIMA QX (00-0
		RENAULT	CLIO II (98-) ESPACE III (96- SAFRANE II (96-
		SUBARU	LEGACY II (94-9 LEGACY OUTBACK SVX (92-97)
PK20PR-L11	IK20TT	ACURA	NSX (90-) NSX Targa (95-9
		AUDI	A4 (8E, B6) (00 A4 (8K, B8) (07 A5 (8T, 8F) (07 A6 (4F, C6) (04 A8 (4E) (02-10) Q5 (8R) (08-)
		CADILLAC	BLS (06-)
		CHEVROLET	EPICA (05-)
		HONDA	LEGEND II (91-9 LEGEND III (96- NSX (90-05)
		KIA	CARNIVAL I (99- CARNIVAL II (99
		LAND ROVER	DISCOVERY IV (0 FREELANDER I (9

DENSO P/N	TT	MAKE	MODEL
PK20PR-L11	IK20TT	LOTUS	ELISE 340R (00- ELISE (95-01)
<i>continued</i>		MG	MG 6 (10-) MG TF (02-09) MG ZR (01-05) MG ZS (01-05) MG ZT (01-05) MGF (95-02)
		NISSAN	ALMERA II (00-) ALMERA TINO (00 SUNNY III (90-0
		OPEL	CORSA D (06-) MERIVA A (03-10 SIGNUM (03-) VECTRA C (02-)
		RENAULT	AVANTIME (01-03
		ROVER	25 (99-05) 45 (00-05) 75 (99-05) 400 (90-98) STREETWISE (03-
		SAAB	9-3 (02-) 9-3X (09-)
		SUZUKI	GRAND VITARA (9
		VAUXHALL	MERIVA I (A) (0 SIGNUM (02-08) VECTRA II (C) (
PK20PR-L13	IK20TT	JAGUAR	XJ (97-03) XK 8 (96-05)
PK20PR-P11	K20TT	MITSUBISHI	3000 GT (92-99) GALANT V (92-96 PAJERO I (82-91 SIGMA (90-96)
PK20PR-P8	IK20TT	ALFA ROMEO	145 147 (00-10) 156 (97-06) 164 (87-98) 166 (98-07) GT (03-10) GTV (95-05) SPIDER (94-05)
		AUDI	A3 (8L) (96-03) A3 (8P) (03-13) A4 (8D, B5) (94 A4 (8E, B6) (00 A4 (8E, B7) (04 A4 Convertible A6 (4B, C5) (97 A6 (4F, C6) (04 ALLROAD (4BH) (TT (8N) (98-06)
		BENTLEY	CONTINENTAL (03 CONTINENTAL Fly
		FORD	ESCORT VI (92-9
		LANCIA	KAPPA (94-01) THESIS (02-09)
		MG	MG X-POWER (03- MG ZR (01-05) MGF (95-02)
		NISSAN	180 SX (88-94) PRIMASTAR (01-) SUNNY III (90-0
		OPEL	ASTRA H (04-) COMBO (01-) VIVARO A (01-) ZAFIRA A (99-05 ZAFIRA B (05-)
		RENAULT	AVANTIME (01-03 ESPACE IV (02-) LAGUNA I (93-01 LAGUNA II (01-)

DENSO P/N	TT	MAKE	MODEL
PK20PR-P8	IK20TT		LAGUNA III (07- MEGANE II (02-) MEGANE III (08- TRAFIC II (01-) TWINGO II (07-) VEL SATIS (02-) WIND (10-)
<i>continued</i>		ROVER	25 (99-05) 45 (00-05) 100 200 (RF) (95-00 400 (95-00) 600 (93-99) COUPE (96-99) STREETWISE (03-
		SEAT	ALHAMBRA (7V) (CORDOBA (6K2) (CORDOBA (6L) (0 EXEO (3R) (08-) IBIZA IV (6L) (LEON (1M) (99-0 TOLEDO II (1M)
		SKODA	OCTAVIA (1U) (9 SUPERB (3U) (01
		SUBARU	FORESTER (97-02 FORESTER (02-) IMPREZA (92-00) IMPREZA (00-) LEGACY I (89-94
		VAUXHALL	ASTRA V (H) (04 COMBO II (C) (0 VIVARO (A) (01- ZAFIRA I (A) (9 ZAFIRA II (B) (
		VOLVO	850 (91-97) C70 I (97-05) S40 I (95-03) S60 I (00-10) S70 (96-00) S80 I (98-06) V40 (95-04) V70 I (96-00) V70 II (00-07) XC70 I Cross Co XC90 I (02-)
		VW	BORA (1J) (98-0 GOLF IV (1J, 1E NEW BEETLE (9C, PASSAT (3B2, 3B PASSAT (3B3, 3B POLO (9N) (01-0 SHARAN (7M) (95
PK20PTR-S9	K20TT	AUDI	A6 (4B, C5) (97 A8 (4D) (94-02)
PK20R11	K20TT	LEXUS	GS (93-97) LS (89-94) LS (94-00)
		TOYOTA	MAJESTA (99-03) MR 2 II (89-00)
PK20R13	K20TT	TOYOTA	AVENSIS (97-03) CARINA E (92-97
PK20R8	IK20TT	TOYOTA	CARINA E (92-97 CELICA (89-93) CELICA (93-99) MR 2 II (89-00)
PK20TR11	K20TT	ALFA ROMEO	145 147 (00-10) 155 (92-97) 156 (97-06) 159 (05-11) 166 (98-07)

Spark & Glow Plugs

Buyers Guide

DENSO P/N	TT	MAKE	MODEL
PK20TR11	K20TT		GT (03-10)
<i>continued</i>			GTV (95-05)
			SPIDER (94-05)
		DAIHATSU	ALTIS (96-01)
		HOLDEN	APOLLO (JM) (93)
		LEXUS	GS (97-05)
		TOYOTA	AVALON (95-05)
			AVENSIS (97-03)
			CAMRY (90-97)
			CAMRY (96-01)
			CAMRY SOLARA (9)
			CAMRY SOLARA (0)
			CELICA (89-93)
			CELICA (93-99)
			CHASER (96-01)
			CURREN (89-94)
			CURREN (93-98)
			HARRIER (98-03)
			MARK II (80-01)
			RAV 4 I
			SCEPTER (92-96)
			SIENNA (97-03)
			SOARER (90-00)
			VISTA (90-98)
			VISTA (98-03)
			WINDOM (96-01)
PK22PR11	-	FORD	ESCORT V (90-94)
			ESCORT VII (95-
PK22PR8	-	ALPINA	B5 (E60, E61) (
			B7 (E65) (03-08
		AUDI	80 (8C, B4) (91
			100 (4A, C4) (9
			200 (44) (83-91
			A3 (8P) (03-13)
			A3 Convertible
			A4 (8D, B5) (94
			A4 (8E, B7) (04
			A4 (8K, B8) (07
			A4 Allroad (8KH
			A4 Convertible
			A5 (8T, 8F) (07
			A6 (4A, C4) (94
			A6 (4B, C5) (97
			A6 (4F, C6) (04
			A6 (4G, C7) (10
			COUPE (89, 8B)
			Q3 (8U) (11-)
			Q5 (8R) (08-)
			QUATTRO (85) (8
			R8 (07-)
			TT (8J) (06-14)
		KTM	X-BOW (08-)
		LOTUS	EXIGE (00-12)
		NISSAN	200 SX (93-99)
		RENAULT	MEGANE II (02-)
		SEAT	ALHAMBRA (710)
			ALTEA (XL) (5P)
			CORDOBA (6K1) (
			EXEO (3R) (08-)
			IBIZA II (6K1)
			LEON (1P) (05-)
			TOLEDO I (1L) (
			TOLEDO III (5P)
		SKODA	OCTAVIA (1Z) (0
			SUPERB (3T) (08
			YETI (5L) (09-)
		SUBARU	IMPREZA (00-)
			LEGACY II (94-9
		VW	AMAROK (10-)
			BEETLE (5C) (11
			CC (358) (11-)

DENSO P/N	TT	MAKE	MODEL
PK22PR8	-		EOS (1F) (06-)
<i>continued</i>			GOLF III (1H, 1
			GOLF V (1K) (03
			GOLF VI (5K, 51
			JETTA III (1K2)
			JETTA IV (162)
			MULTIVAN V (7H,
			PASSAT (3C) (05
			PASSAT (362, 36
			PASSAT CC (357)
			SCIROCCO (137)
			SHARAN (7N) (10
			TIGUAN (5N) (07
			TRANSPORTER V (
PK22PR-L11S	-	FORD	GALAXY (95-06)
			TRANSIT (94-00)
			TRANSIT TOURNEO
		HONDA	INTEGRA (93-01)
			S2000 (99-)
		PORSCHE	911 (997) (04-1
		SAAB	9-5 (97-)
		TOYOTA	ALTEZZA (99-05)
PKJ16CR8	-	MAZDA	626 V (97-02)
			XEDOS 9 (93-02)
PKJ16CR-L11	IK16TT	FORD	GALAXY (95-06)
		SEAT	ALHAMBRA (7V) (
			CORDOBA (6K2) (
			CORDOBA (6L) (0
			IBIZA III (6K2)
			IBIZA IV (6L) (
			INCA (6K9) (95-
			LEON (1M) (99-0
			TOLEDO II (1M)
		SKODA	OCTAVIA (1U) (9
		VW	BORA (1J) (98-0
			CADDY II (9K, 9
			FOX (5Z) (03-)
			GOLF IV (1J, 1E
			LUPPO (6X, 6E) (
			NEW BEETLE (9C,
			PASSAT (3B3, 3B
			POLO (6N2) (99-
			POLO Saloon (9A
			SHARAN (7M) (95
			TRANSPORTER IV
PKJ16CR-L13	IK16TT	CHRYSLER	300 M (98-04)
		ISUZU	ASKA (95-01)
PKJ20CR8	-	AUDI	A1 (8X) (10-)
			A3 (8P) (03-13)
			A3 Convertible
		MAZDA	626 V (97-02)
		SEAT	ALTEA (XL) (5P)
			IBIZA V (6J) (0
			LEON (1P) (05-)
			TOLEDO IV (KG3)
		SKODA	FABIA (06-14)
			OCTAVIA (1Z) (0
			RAPID (HN) (12-
			SUPERB (3T) (08
			YETI (5L) (09-)
		VW	BEETLE (5C) (11
			EOS (1F) (06-)
			GOLF PLUS (5M,
			GOLF V (1K) (03
			GOLF VI (5K, 51
			JETTA III (1K2)
			JETTA IV (162)
			PASSAT (3C) (05
			PASSAT (362, 36
			POLO (6R, 6C) (
			SCIROCCO (137)

DENSO P/N	TT	MAKE	MODEL
PKJ20CR8	-		TIGUAN (5N) (07)
<i>continued</i>			TOURAN (1T1, 1T)
			TOURAN (1T3) (1)
PKJ20CR-L11	IK20TT	AUDI	A8 (4D) (94-02)
			A8 (4E) (02-10)
		HONDA	ACCORD VI (97-0)
			PRELUDE IV (92-
			PRELUDE V (96-0)
		SPYKER	C12 (07-)
		VW	PHAETON (3D) (0)
			TOUAREG (7L) (0)
PKJ20CR-M11	IK20TT	HONDA	INSPIRE (98-03)
PQ16R	Q16TT	TOYOTA	CELICA (77-85)
			CELICA (85-89)
			COROLLA (E8) (8)
			COROLLA (E9) (8)
			COROLLA FX (84-
			MR 2 I (84-90)
			SUPRA (86-93)
PQ16R8	Q16TT	TOYOTA	CELICA (85-89)
PQ20R	Q20TT	LEXUS	ES (89-97)
		NISSAN	200 SX (88-94)
			BLUEBIRD (85-92)
			SKYLINE (R32) (
			SKYLINE (R33) (
			SUNNY II (86-91)
		SAAB	9-3 (98-03)
			9-5 (97-)
		TOYOTA	CAMRY (86-91)
			CAMRY (90-97)
			CARINA E (92-97)
			COROLLA (E9) (8)
			COROLLA (E10) (
PQ20R-P8	IQ20TT	TOYOTA	SUPRA (86-93)
PT16EPR-L13	IT16TT	ASTON MARTIN	DB7 (94-03)
		CADILLAC	ALLANTE (88-93)
			DEVILLE (93-99)
			DEVILLE (99-04)
			DTS (05-)
			ELDORADO (91-02)
			ESCALADE (98-06)
			SEVILLE II (K)
			SEVILLE III (6K)
			SEVILLE IV (97-
			SRX (04-08)
			STS (04-)
			XLR (04-09)
		FORD	COUGAR (98-01)
			FIESTA IV (95-0)
			MONDEO I (93-96)
			MONDEO II (96-0)
			MONDEO III (00-
		FORD USA	AEROSTAR (85-97)
			EXPLORER (93-01)
			F150 (96-03)
			MUSTANG (93-)
			MUSTANG (04-)
			TAURUS (95-)
			WINDSTAR (95-)
		LAND ROVER	DISCOVERY III (
		MAZDA	121 III (96-03)
			MPV II (99-06)
		PONTIAC	TRANS SPORT (97
PT16VR10	TV16TT	FORD	ESCORT V (90-94)
			ESCORT VI (92-9)
			ESCORT VII (95-
			FIESTA III (89-
			FIESTA IV (95-0)
			MONDEO I (93-96)
			MONDEO II (96-0)
			ORION III (90-9)

DENSO P/N	TT	MAKE	MODEL
PT16VR10	TV16TT	MAZDA	121 III (96-03)
<i>continued</i>		MORGAN	FOUR FOUR (68-)
			PLUS FOUR (85-)
		WESTFIELD	130 (97-)
			ZE (93-97)
PT16VR13	TV16TT	ALFA ROMEO	159 (05-11)
			BRERA (06-)
			SPIDER (06-)
		CADILLAC	CTS (02-07)
			CTS (08-)
			SRX (04-08)
			STS (04-)
		CHEVROLET	CAPTIVA (06-)
			TRAILBLAZER (01
		FIAT	CROMA (05-)
		FORD	FOCUS I (98-05)
			MAVERICK (01-)
			MONDEO I (93-96)
			PUMA (97-02)
		FORD USA	ESCAPE (01-07)
		HUMMER	HUMMER H3 (05-)
		MAZDA	2 (03-)
			TRIBUTE (00-08)
		OPEL	ANTARA (06-)
			ASTRA G (98-09)
			SPEEDSTER (00-)
			VECTRA B (95-03)
			VECTRA C (02-)
			ZAFIRA A (99-05)
		RENAULT	19 I (88-92)
		SUZUKI	GRAND VITARA (0
		VAUXHALL	ANTARA (06-)
			ASTRA IV (G) (9
			SPEEDSTER (VX22
			VECTRA I (B) (9
			VECTRA II (C) (
			ZAFIRA I (A) (9
		VOLVO	C30 (06-12)
			S40 II (04-)
			V50 (04-)
PTJ16R15	IT16TT	HOLDEN	STATESMAN (99-0
		HUMMER	HUMMER H2 (02-)
Q14R-U11	IQ16TT	NISSAN	SUNNY II (86-91)
Q16PR-U	Q16TT	CITROËN	AX (86-98)
			BX (82-94)
		PEUGEOT	106 I (91-96)
			205 I (83-94)
			306 (93-02)
			405 II (92-99)
		RENAULT	CLIO I (90-98)
			MEGANE I (96-03)
			MEGANE Scénic (
		SKODA	FAVORIT (78) (8
			FELICIA Fun (97
			FELICIA I (6U)
Q16PR-U11	Q16TT	DAEWOO	KORANDO (99-)
			MUSSO (99-)
			REXTON (02-)
		MITSUOKA	GALUE (96-)
		NISSAN	BLUEBIRD (85-92)
			PRIMERA (90-98)
			SUNNY III (90-0
		SSANGYONG	ACTYON I (05-)
			CHAIRMAN (97-)
			ISTANA (92-)
			KORANDO (96-)
			KYRON (05-)
			MUSSO (93-)
			REXTON (02-)
			RODIUS I (05-)
			STAVIC (05-)

Spark & Glow Plugs

Buyers Guide

DENSO P/N	TT	MAKE	MODEL		
Q16P-U11	Q16TT	PEUGEOT	205 I (83-94)		
			205 II (87-98)		
		RENAULT	19 II (92-01)		
			RAPID (85-98)		
Q16R-U	Q16TT	RENAULT	CLIO I (90-98)		
		TOYOTA	CARINA E (92-97)		
			CARINA II (83-9		
			CELICA (89-93)		
			COROLLA (E9) (8		
			COROLLA (E10) (
Q16R-U11	Q16TT	CHEVROLET	MATIZ (05-)		
		NISSAN	300 ZX (84-90)		
		TOYOTA	CAMRY (86-91)		
			CARINA II (83-9		
			COROLLA (E9) (8		
			PICNIC (96-01)		
Q16TT	-	CHEVROLET	MATIZ (05-)		
		CITROËN	AX (86-98)		
			BX (82-94)		
		DAEWOO	KORANDO (99-)		
			MUSSO (99-)		
			REXTON (02-)		
		JEEP	CJ5 - CJ8 (66-8		
		MITSUOKA	GALUE (96-)		
		NISSAN	300 ZX (84-90)		
			BLUEBIRD (85-92		
			PRIMERA (90-98)		
			SUNNY III (90-0		
		PEUGEOT	106 I (91-96)		
			205 I (83-94)		
			205 II (87-98)		
			306 (93-02)		
			405 II (92-99)		
		RENAULT	19 II (92-01)		
			CLIO I (90-98)		
			MEGANE I (96-03		
			MEGANE Scénic (
			RAPID (85-98)		
		SKODA	FAVORIT (78) (8		
			FELICIA Fun (97		
			FELICIA I (6U)		
		SSANGYONG	ACTYON I (05-)		
			CHAIRMAN (97-)		
			ISTANA (92-)		
			KORANDO (96-)		
			KYRON (05-)		
			MUSSO (93-)		
			REXTON (02-)		
			RODIUS I (05-)		
			STAVIC (05-)		
			TOYOTA	CAMRY (86-91)	
				CARINA E (92-97	
		CARINA II (83-9			
		CELICA (77-85)			
		CELICA (85-89)			
		CELICA (89-93)			
		COROLLA (E8) (8			
		COROLLA (E9) (8			
		COROLLA (E10) (
		COROLLA FX (84-			
		MR 2 I (84-90)			
		PICNIC (96-01)			
		SUPRA (86-93)			
		Q20PR-U		Q20TT	ASTON MARTIN
			VIRAGE (90-00)		
			AUSTIN		1000-Series (70
CITROËN	AX (86-98)				
	BX (82-94)				
	C15 (84-05)				
	EVASION (94-02)				
JUMPER (94-02)					

DENSO P/N	TT	MAKE	MODEL
Q20PR-U	Q20TT		JUMPY (95-)
			XM (89-94)
			ZX (91-98)
		DAEWOO	MUSSO (99-)
		FIAT	DUCATO (94-02)
			PANDA (80-04)
			PUNTO (93-00)
			TIPO (87-95)
			UNO (83-00)
		FORD	ESCORT III (80-
			ESCORT IV (85-9
			ESCORT V (90-94
			ESCORT VI (92-9
			FIESTA II (83-9
FIESTA III (89-			
ORION I (83-86)			
ORION II (85-90			
ORION III (90-9			
SCORPIO I (85-9			
SIERRA (87-93)			
JAGUAR	XJ (86-94)		
	XJ (94-97)		
	XJ Coupe (73-96		
LANCIA	Y (95-03)		
	Y10 (85-95)		
MAZDA	323 III (85-95)		
	626 II (82-87)		
	626 III (87-97)		
	929 III (87-91)		
MERCEDES-BENZ	E-CLASS (124) (
	E-CLASS Coupe		
MORGAN	FOUR FOUR (68-)		
	PLUS FOUR (85-)		
MORRIS	ITAL (80-84)		
NISSAN	BLUEBIRD (83-90		
	BLUEBIRD (85-92		
	PRAIRIE (83-88)		
	STANZA (81-85)		
	SUNNY II (86-91		
OPEL	MONTEREY A (91-		
	VECTRA A (88-95		
PEUGEOT	205 I (83-94)		
	205 II (87-98)		
	305 II (82-90)		
	306 (93-02)		
	309 I (85-89)		
	309 II (89-93)		
	405 I (87-93)		
	405 II (92-99)		
	504 (68-89)		
	505 (79-95)		
	605 (89-99)		
	BOXER (94-02)		
	J5 (81-90)		
	J5 (90-94)		
PARTNER			
PONTIAC	TRANS SPORT (89		
RELIANT	SCIMITAR (68-90		
SKODA	FAVORIT (78) (8		
SSANGYONG	KORANDO (96-)		
	MUSSO (93-)		
VOLVO	960 I (90-94)		
	960 II (94-96)		
Q20PR-U11	Q20TT	FORD	ESCORT IV (85-9
			ESCORT V (90-94
			ESCORT VI (92-9
			ESCORT VII (95-
			FIESTA II (83-9
			FIESTA III (89-
			ORION II (85-90
ORION III (90-9			

DENSO P/N	TT	MAKE	MODEL
Q20TT	-		E-CLASS Coupe
<i>continued</i>			G-CLASS (W463)
			KOMBI (S124) (8
			Saloon (W124) (
			S-CLASS (W140)
			S-CLASS Coupe (
			SL (R129) (89-0
		MORGAN	FOUR FOUR (68-)
			PLUS FOUR (85-)
		MORRIS	ITAL (80-84)
		NISSAN	200 SX (88-94)
			300 ZX (84-90)
			BLUEBIRD (83-90
			BLUEBIRD (85-92
			CEDRIC (83-87)
			PATHFINDER (97-
			PRAIRIE (83-88)
			PRAIRIE Pro (88
			SILVIA (84-88)
			SKYLINE (R32) (
			SKYLINE (R33) (
			STANZA (81-85)
			SUNNY II (86-91
		OPEL	MONTEREY A (91-
			VECTRA A (88-95
		PEUGEOT	205 I (83-94)
			205 II (87-98)
			305 II (82-90)
			306 (93-02)
			309 I (85-89)
			309 II (89-93)
			405 I (87-93)
			405 II (92-99)
			504 (68-89)
			505 (79-95)
			605 (89-99)
			BOXER (94-02)
			J5 (81-90)
			J5 (90-94)
			PARTNER
		PONTIAC	TRANS SPORT (89
		RELIANT	SCIMITAR (68-90
		RENAULT	19 I (88-92)
			19 II (92-01)
		ROVER	400 (95-00)
		SAAB	9-3 (98-03)
			9-5 (97-)
			900 I (78-94)
			900 II (93-98)
			9000 (84-98)
		SKODA	FAVORIT (78) (8
		SSANGYONG	KORANDO (96-)
			MUSSO (93-)
		TOYOTA	CAMRY (86-91)
			CAMRY (90-97)
			CARINA E (92-97
			CARINA II (83-9
			CELICA (77-85)
			CELICA (85-89)
			COROLLA (E9) (8
			COROLLA (E10) (
			MR 2 I (84-90)
		VOLVO	960 I (90-94)
			960 II (94-96)
		WESTFIELD	130 (97-)
Q22PR-U	-	ALFA ROMEO	155 (92-97)
		ASTON MARTIN	DB7 (94-03)
		CATERHAM	21 (94-)
		CITROËN	AX (86-98)
			BX (82-94)
			XM (89-94)

DENSO P/N	TT	MAKE	MODEL
Q22PR-U	-	FIAT	ELBA (86-96)
<i>continued</i>			PUNTO (93-00)
			SCUDO (96-06)
			TEMPRA (90-96)
			TIPO (87-95)
		FORD	ESCORT III (80-
			ESCORT IV (85-9
			FIESTA I (76-86
			ORION I (83-86)
			ORION II (85-90
		LANCIA	DEDRA (89-99)
		PEUGEOT	306 (93-02)
			605 (89-99)
			EXPERT (96-)
		SAAB	9000 (84-98)
		SEAT	IBIZA I (84-93)
			MALAGA (84-93)
Q22PR-U11	-	NISSAN	300 ZX (84-90)
		SAAB	9-3 (98-03)
			9-5 (97-)
			900 II (93-98)
			9000 (84-98)
Q22P-U	-	CITROËN	BX (82-94)
			VISA (78-91)
		FORD	ESCORT III (80-
			ESCORT IV (85-9
			ORION I (83-86)
		PEUGEOT	205 II (87-98)
			309 I (85-89)
		SEAT	IBIZA I (84-93)
			MALAGA (84-93)
			RONDA (82-88)
QJ16AR-U	-	DODGE	VIPER (02-)
		JEEP	WRANGLER I (86-
		TOYOTA	CARINA II (83-9
			COROLLA (E9) (8
QJ16CR11	Q16TT	JEEP	CJ5 - CJ8 (66-8
QJ16HR-U9	-	CHRYSLER	NEW YORKER (93-
			VISION (93-97)
		JEEP	CHEROKEE (80-86
			GRAND CHEROKEE
QJ20CR11	Q20TT	MAZDA	626 III (87-97)
			929 III (87-91)
S22PR-A7	-	MITSUBISHI	LANCER EVO (92-
S-31A	-	MAZDA	RX 7 II (85-91)
SC16HR11	IXEH20TT	CITROËN	C1 II (14-)
		PEUGEOT	108 (14-)
		TOYOTA	AURIS (12-)
			AYGO (05-)
			AYGO (14-)
			COROLLA (E16) (
			COROLLA (E18) (
			IQ (09-)
			URBAN CRUISER (
			VERSO S (10-)
			YARIS (10-)
SC20HR11	IXEH22TT	ASTON MARTIN	CYGNET (11-13)
		DAIHATSU	CHARADE VI (11-
		LEXUS	CT (10-)
		LOTUS	ELISE (00-)
		SUBARU	TREZIA (11-)
		TOYOTA	ALLION I (01-07
			ALLION II (07-)
			AURIS (06-)
			AURIS (12-)
			AVENSIS (09-)
			COROLLA (E12) (
			COROLLA (E14, E
			COROLLA (E16) (
			COROLLA (E18) (
			COROLLA Rumion

DENSO P/N	TT	MAKE	MODEL
SC20HR11	IXEH22TT		IQ (09-)
<i>continued</i>			ISIS (04-)
			PREMIO (07-)
			PRIUS (09-)
			PRIUS PLUS (11-)
			RAV 4 III (05-)
			RAV 4 IV (12-)
			URBAN CRUISER (
			VERSO (09-)
			VERSO S (10-)
			WISH (09-)
			YARIS (05-)
			YARIS (10-)
SK16HR11	IKH16TT	DODGE	CHARGER (11-)
		LEXUS	ES (12-)
			GX (09-)
			RX (08-)
		TOYOTA	AYGO (05-)
			CAMRY (06-11)
			CAMRY (11-)
			IQ (09-)
			KLUGER
			RAV 4 IV (12-)
			VENZA (08-)
			YARIS (05-)
			YARIS (10-)
			ZELAS (11-)
SK16PR-A11	IK16TT	JAGUAR	XF (08-)
			XJ (97-03)
			XJ (03-09)
			XJ (09-)
			XK 8 (96-05)
			XK (06-14)
		SUZUKI	GRAND VITARA (0
			IGNIS I (00-03)
SK16PR-E11	IK16TT	MAZDA	2 (03-)
			3 (00-09)
			3 (09-)
SK16PR-L11	IK16TT	HONDA	CIVIC VII (00-0
		HYUNDAI	COUPE (01-09)
			ELANTRA (05-11)
			GETZ (02-09)
			GRANDEUR (05-)
			i30 (07-12)
			ix55 (08-)
			MATRIX (01-10)
			SANTA FÉ I (00-
			SANTA FÉ II (06
			SONATA V (05-)
			TIBURON (06-)
			TRAJECT (00-08)
			TUCSON (04-10)
		KIA	CARENS II (02-)
			CARNIVAL III (0
			CEED (06-)
			OPIRUS (03-)
			PRO CEED (08-)
			SPORTAGE II (04
SK16R11	IK16TT	FIAT	MAREA (96-07)
		LAND ROVER	RANGE ROVER III
			RANGE ROVER SPO
		TOYOTA	HIACE IV (95-)
			PRIUS (00-04)
			PRIUS (03-09)
SK16R-P11	IK16TT	TOYOTA	CENTURY (97-)
			SUPRA (93-02)
SK16R-P8	IK16TT	TOYOTA	HIACE IV (95-)
SK20BGR11	-	TOYOTA	WISH (03-09)
			WISH (09-)
SK20BR11	-	TOYOTA	AVENSIS (97-03)
			AVENSIS (03-09)

DENSO P/N	TT	MAKE	MODEL
SK20HR11	IKH20TT	DAIHATSU	BOON (06-)
			CUORE VIII (07-
			SIRION (05-)
		LEXUS	GS (05-11)
			LS (06-)
			LX (07-)
		SUBARU	JUSTY IV (07-)
		SUZUKI	SWIFT IV (10-)
			SX4 S-Cross (13
		TOYOTA	CROWN (03-08)
			DYNA (01-)
			HIACE V (05-)
			LAND CRUISER (J
			LAND CRUISER
			LAND CRUISER
			SEQUOIA (00-)
			TUNDRA (07-)
SK20PR-A11	IK20TT	SUZUKI	IGNIS I (00-03)
			LIANA (01-)
		VOLVO	S80 II (06-)
			XC90 I (02-)
SK20PR-A8	IK20TT	DAIHATSU	MOVE (02-)
		MITSUBISHI	ASX (10-)
			LANCER (07-)
			PAJERO IV (06-)
SK20PR-L11	IK20TT	HONDA	CIVIC VIII Hatc
SK20PR-L9	IK20TT	CHRYSLER	CROSSFIRE (03-0
		MERCEDES-BENZ	A-CLASS (W169)
			B-CLASS (W245)
			C-CLASS (203) (
			C-CLASS Coupe (
			CLK (209) (02-1
			E-CLASS (210) (
			S-CLASS (W220)
			S-CLASS Coupe (
			SLK (R170) (96-
			SLK (R171) (04-
SK20R11	IK20TT	DAIHATSU	ALTIS (06-)
		LEXUS	GS (97-05)
			GS (05-11)
			GX (01-09)
			IS I (99-05)
			LS (94-00)
			LS (00-06)
			LX (98-08)
			RX (00-03)
			RX (03-08)
			SC (01-10)
		LOTUS	2 ELEVEN (07-11
			ELISE (00-)
			EXIGE (00-12)
		MITSUOKA	OROCHI (06-)
		TOYOTA	ALPHARD I (03-0
			ALPHARD II (08-
			AURIS (06-)
			AVALON (99-05)
			AVENSIS (03-09)
			AVENSIS Verso (
			CAMRY (01-06)
			CAMRY (06-11)
			CAMRY (11-)
			CAMRY SOLARA (0
			CAMRY SOLARA (0
			CAMRY SOLARA (0
			CELICA (99-05)
			COROLLA (E12) (
			CROWN (08-12)
			HARRIER (98-03)
			HARRIER (03-)
			KLUGER
			LAND CRUISER (J

Spark & Glow Plugs

Buyers Guide

DENSO P/N	TT	MAKE	MODEL
SK20R11	IK20TT		LAND CRUISER (J)
<i>continued</i>			LAND CRUISER
			PREVIA II (00-0)
			RAV 4 II (00-05)
			RAV 4 III (05-)
			SEQUOIA (00-)
			SIENNA (03-09)
			WINDOM (01-06)
		TOYOTA (FAW)	LAND CRUISER (0)
SK20R5-G	-	TOYOTA	COASTER (93-)
			DYNA (01-)
SK20R-P11	IK20TT	LEXUS	GS (97-05)
			IS 1 (99-05)
		TOYOTA	ALTEZZA (99-05)
SK20R-P13	IK20TT	TOYOTA	AVENSIS (97-03)
SK22PR-M11S	-	HONDA	CIVIC VII (00-0)
			CIVIC VIII Hatc
			INTEGRA (02-)
SKJ16CR-L11	IK16TT	SKODA	FABIA (6Y) (99-)
		VW	JETTA III (1K2)
			NEW BEETLE (9C,
			POLO (9N) (01-0)
SKJ20CR-A8	-	MAZDA	323 F VI (98-04)
			323 S VI (98-04)
			XEDOS 9 (93-02)
		SEAT	IBIZA V (6J) (0)
SKJ20DR-M11	IK20TT	ACURA	MDX (00-05)
		HONDA	ACCORD VII (03-
			ACCORD VIII (08
			CIVIC VIII Salo
			CR-V III (06-)
			ELEMENT (02-11)
			ELYSION (04-)
			LAGREAT (98-02)
			LEGEND IV (06-)
			ODYSSEY (02-)
			PILOT (05-08)
			RIDGELINE (05-)
		MITSUOKA	NOUERA (02-)
SKJ20DR-M11S	-	HONDA	ACCORD VIII (08
			CIVIC VII (00-0)
			CIVIC VIII Hatc
			CIVIC VIII Salo
			FR-V (04-)
SKJ20DR-M13	IK20TT	HONDA	CIVIC IX (12-)
			CIVIC VIII Hatc
			JAZZ III (08-)
SXU22HCR11S	-	DODGE	CHARGER (11-)
		HONDA	LEGEND IV (06-)
			ODYSSEY (02-)
SXU22HDR8	-	HYUNDAI	i10 (07-)
			i20 (08-)
		MERCEDES-BENZ	C-CLASS (203) (
			C-CLASS (204) (
			C-CLASS Coupe (
			CLC (CL203) (08
			CLK (209) (02-1
			CLS (C219) (04-
			E-CLASS (211) (
			E-CLASS (212) (
			E-CLASS Coupe
			GL-CLASS (X164)
			GLK (X204) (08-
			M-CLASS (W164)
			M-CLASS (W166)
			R-CLASS (251) (
			S-CLASS (W221)
			S-CLASS Coupe (
			SL (R230) (01-1
			SLK (R171) (04-
			SPRINTER 3,5 (9

DENSO P/N	TT	MAKE	MODEL
SXU22HDR8	-		SPRINTER 3-t (9
<i>continued</i>			SPRINTER 4,6-t
			SPRINTER 5-t (9
			VIANO (W639) (0
			VITO
		MITSUBISHI	i-MiEV (06-)
			OUTLANDER II (0
SXU22PR9	-	DAIHATSU	BEGO (05-)
			MATERIA (06-)
			TERIOS (05-)
		PERODUA	ALZA (09-)
		TOYOTA	RUSH (06-)
T16EPR-U	T16TT	FORD	KA (96-08)
			SCORPIO I (85-9
			SIERRA (87-93)
		FORD USA	BRONCO II (85-9
			TAURUS (91-95)
		PONTIAC	BONNEVILLE (86-
T16EPR-U15	T16TT	BUICK	LE SABRE (85-91
			LE SABRE (91-95
			PARK AVENUE (90
			SKYLARK (94-99)
		CADILLAC	ALLANTE (88-93)
			DEVILLE (90-93)
			DEVILLE (93-99)
			ELDORADO (87-91
			SEVILLE II (K)
		CHEVROLET	ALERO (99-04)
			BLAZER (S10) (9
			CAVALIER (91-03
			EXPRESS (95-98)
			MALIBU (96-05)
			S10 Pick Up (94
		GMC	JIMMY (94-02)
		MAZDA	6 (02-07)
			6 (07-)
T16NR-U11	IT16TT	FORD USA	TAURUS (88-92)
			THUNDERBIRD (93
T16PR-U	ITF16TT	PONTIAC	FIREBIRD (81-92
T16PR-U11	ITF16TT	AC	ACE (95-98)
			COBRA IV (90-)
		CHEVROLET	ASTRO (84-94)
			BLAZER (S10) (8
			BLAZER (S10) (9
			C1500 (91-00)
			C2500 (91-96)
			CAMARO (70-81)
			CAMARO (81-92)
			CAPRICE (70-83)
			CAPRICE (81-90)
			MALIBU (80-83)
			S10 Pick Up (83
			S10 Pick Up (94
		FORD USA	ECONOLINE (76-9
		GMC	G SERIE (75-84)
		PONTIAC	FIREBIRD (81-92
T16PR-U15	ITF16TT	PONTIAC	TRANS SPORT (89
T16TT	-	BUICK	LE SABRE (85-91
			LE SABRE (91-95
			PARK AVENUE (90
			SKYLARK (94-99)
		CADILLAC	ALLANTE (88-93)
			DEVILLE (90-93)
			DEVILLE (93-99)
			ELDORADO (87-91
			SEVILLE II (K)
		CHEVROLET	ALERO (99-04)
			BLAZER (S10) (9
			CAVALIER (91-03
			EXPRESS (95-98)
			MALIBU (96-05)

DENSO P/N	TT	MAKE	MODEL
T16TT	-		S10 Pick Up (94)
<i>continued</i>		FORD	KA (96-08) SCORPIO I (85-9) SIERRA (87-93)
		FORD USA	BRONCO II (85-9) TAURUS (91-95)
		GMC	JIMMY (94-02)
		MAZDA	6 (02-07) 6 (07-)
		PONTIAC	BONNEVILLE (86-)
T16VR-U10	TV16TT	FORD	B-MAX (12-) C-MAX I (07-) C-MAX II (10-) COUGAR (98-01) FIESTA V (01-08) FIESTA VI (08-) FOCUS C-MAX (03) FOCUS I (98-05) FOCUS II (04-) FOCUS III (11-) FUSION (02-) GRAND C-MAX (10 KA (96-08) MONDEO IV (07-) P 100 (87-92) PUMA (97-02) STREET KA (03-0 TOURNEO Connect TRANSIT CONNECT
		MAZDA	2 (03-) 3 (00-09) 6 (02-07) 6 (07-)
T20EPR-U	T20TT	ALPINE	A310 (71-84)
		AUDI	100 (4A, C4) (9 A6 (4A, C4) (94 A8 (4D) (94-02) V8 (44, 4C) (88
		AUSTIN	AMBASSADOR (82-
		CITROËN	BX (82-94) GS (70-86) LNA (76-86)
		FORD	ESCORT IV (85-9 ESCORT V (90-94 ESCORT VI (92-9 ESCORT VII (95- FIESTA I (76-86 FIESTA II (83-9 FIESTA III (89- FIESTA IV (95-0 ORION II (85-90 ORION III (90-9 SCORPIO I (85-9
		FORD USA	EXCURSION (99-0 WINDSTAR (95-)
		JAGUAR	XJ (94-97) XJ Coupe (73-96 XJSC (85-96)
		LDV	SHERPA (74-89)
		MORRIS	ITAL (80-84)
		PEUGEOT	104 (72-88) 205 I (83-94) 205 II (87-98) 305 I (77-82) 305 II (82-90) 505 (79-95) 604 (77-87)
		PROTON	GEN 2 (04-)
		RENAULT	5 (72-85) 14 (76-83) 18 (78-93)

DENSO P/N	TT	MAKE	MODEL
T20EPR-U	T20TT		20 (75-83) 25 (84-93) 30 (75-86) FUEGO (80-85) MASTER I (80-98 SAFRANE I (92-9 TRAFIC (89-01)
		ROVER	2000-3500 (76-8
		TALBOT	SAMBA (81-86) TAGORA (80-87)
		TVR	S (86-96)
		VOLVO	260 (74-82) 760 (81-92) 780 (86-90)
T20EPR-U15	T20TT	CHEVROLET	AVALANCHE (00-0 SILVERADO (99-) TAHOE (99-06) TRANS SPORT (96 EXPLORER (93-01 PROBE I (88-93)
		FORD USA	SIERRA (97-07) SUBURBAN (99-)
		GMC	6 (02-07)
		MAZDA	6 (02-07)
		MERCURY	GRAND MARQUIS (
		PONTIAC	TRANS SPORT (89
T20EP-U	T20TT	CITROËN	BX (82-94) C15 (84-05) CX I (74-85) CX II (85-92) LNA (76-86) VISA (78-91)
		FORD	ESCORT III (80-
		MERCEDES-BENZ	190 (W201) (82- COUPE (C123) (7 COUPE (C124) (8 E-CLASS (124) (G-CLASS (W460) G-CLASS (W461) G-CLASS (W463) KOMBI (S123) (7 KOMBI (S124) (8 Saloon (W123) (Saloon (W124) (S-CLASS (W126) SL (R107) (71-8 SL (R129) (89-0 T1 (601) (77-96
		PEUGEOT	104 (72-88) 205 I (83-94) 205 II (87-98) 305 I (77-82) 305 II (82-90) 309 I (85-89) 504 (68-89)
		PUCH	G-MODELL (W460) G-MODELL (W461) G-MODELL (W463)
		RENAULT	21 (86-95) ESPACE I (84-92 ESPACE II (91-9 TRAFIC (89-01)
T20PR-U	ITF20TT	CHEVROLET	C2500 (96-) C-K SERIE (94-0 SUBURBAN (91-00
T20PR-U11	ITF20TT	PONTIAC	FIREBIRD (81-92
T20PR-U15	ITF20TT	CHEVROLET	CAMARO (92-02)
		PONTIAC	FIREBIRD (92-)
T20TT	-	ALPINE	A310 (71-84)
		ASTON MARTIN	DB9 (04-) VANQUISH (01-07
		AUDI	100 (4A, C4) (9

Spark & Glow Plugs

Buyers Guide

DENSO P/N	TT	MAKE	MODEL
T20TT	-		A6 (4A, C4) (94)
<i>continued</i>			A8 (4D) (94-02)
			V8 (44, 4C) (88)
		AUSTIN	AMBASSADOR (82-
		CHEVROLET	AVALANCHE (00-0
			SILVERADO (99-)
			TAHOE (99-06)
			TRANS SPORT (96
		CITROËN	BX (82-94)
			C15 (84-05)
			CX I (74-85)
			CX II (85-92)
			GS (70-86)
			LNA (76-86)
			VISA (78-91)
		FORD	C-MAX I (07-)
			ESCORT III (80-
			ESCORT IV (85-9
			ESCORT V (90-94
			ESCORT VI (92-9
			ESCORT VII (95-
			FIESTA I (76-86
			FIESTA II (83-9
			FIESTA III (89-
			FIESTA IV (95-0
			FOCUS C-MAX (03
			FOCUS II (04-)
			GALAXY (06-)
			MAVERICK (01-)
			MONDEO III (00-
			MONDEO IV (07-)
			ORION II (85-90
			ORION III (90-9
			SCORPIO I (85-9
			S-MAX (06-)
		FORD USA	EXCURSION (99-0
			EXPLORER (93-01
			PROBE I (88-93)
			WINDSTAR (95-)
		GMC	SIERRA (97-07)
			SUBURBAN (99-)
		JAGUAR	S-TYPE (99-08)
			XF (08-)
			XJ (94-97)
			XJ (03-09)
			XJ (09-)
			XJ Coupe (73-96
			XJSC (85-96)
			XK 8 (96-05)
			X-TYPE (01-09)
		LDV	SHERPA (74-89)
		MAZDA	3 (00-09)
			5 (05-)
			6 (02-07)
			MPV II (99-06)
			MPV III (06-)
			TRIBUTE (00-08)
		MERCEDES-BENZ	190 (W201) (82-
			COUPE (C123) (7
			COUPE (C124) (8
			E-CLASS (124) (
			G-CLASS (W460)
			G-CLASS (W461)
			G-CLASS (W463)
			KOMBI (S123) (7
			KOMBI (S124) (8
			Saloon (W123) (
			Saloon (W124) (
			S-CLASS (W126)
			SL (R107) (71-8
			SL (R129) (89-0

DENSO P/N	TT	MAKE	MODEL
T20TT	-		T1 (601) (77-96
<i>continued</i>		MERCURY	GRAND MARQUIS (
		MORGAN	ROADSTER (04-)
		MORRIS	ITAL (80-84)
		PEUGEOT	104 (72-88)
			205 I (83-94)
			205 II (87-98)
			305 I (77-82)
			305 II (82-90)
			309 I (85-89)
			504 (68-89)
			505 (79-95)
			604 (77-87)
		PONTIAC	TRANS SPORT (89
		PROTON	GEN 2 (04-)
		PUCH	G-MODELL (W460)
			G-MODELL (W461)
			G-MODELL (W463)
		RENAULT	5 (72-85)
			14 (76-83)
			18 (78-93)
			20 (75-83)
			21 (86-95)
			25 (84-93)
			30 (75-86)
			ESPACE I (84-92
			ESPACE II (91-9
			FUEGO (80-85)
			MASTER I (80-98
			SAFRANE I (92-9
			TRAFIC (89-01)
		ROVER	2000-3500 (76-8
		SHELBY	SERIES 1 (98-)
		TALBOT	SAMBA (81-86)
			TAGORA (80-87)
		TVR	S (86-96)
		VOLVO	260 (74-82)
			760 (81-92)
			780 (86-90)
			C30 (06-12)
			S40 II (04-)
			S80 II (06-)
			V50 (04-)
			V70 III (07-)
T22EP-U	-	ALPINE	V6 (85-90)
		CITROËN	AXEL (81-91)
			BX (82-94)
			CX I (74-85)
			CX II (85-92)
			VISA (78-91)
		DAIMLER	2.8 - 5.3 (69-9
			DAIMLER XJ (94-
		JAGUAR	XJ (68-93)
			XJ Coupe (73-96
			XJSC (85-96)
		MERCEDES-BENZ	190 (W201) (82-
		PEUGEOT	104 (72-88)
			205 I (83-94)
			205 II (87-98)
			305 II (82-90)
			309 I (85-89)
			505 (79-95)
		RENAULT	21 (86-95)
			25 (84-93)
			ESPACE I (84-92
			ESPACE II (91-9
TV16TT	-	ALFA ROMEO	159 (05-11)
			BRERA (06-)
			SPIDER (06-)
		CADILLAC	CTS (02-07)
			CTS (08-)

DENSO P/N	TT	MAKE	MODEL
TV16TT	-		SRX (04-08)
<i>continued</i>			STS (04-)
		CHEVROLET	CAPTIVA (06-)
			TRAILBLAZER (01)
		FIAT	CROMA (05-)
		FORD	B-MAX (12-)
			C-MAX I (07-)
			C-MAX II (10-)
			COUGAR (98-01)
			ESCORT V (90-94)
			ESCORT VI (92-9)
			ESCORT VII (95-)
			FIESTA III (89-)
			FIESTA IV (95-0)
			FIESTA V (01-08)
			FIESTA VI (08-)
			FOCUS C-MAX (03)
			FOCUS I (98-05)
			FOCUS II (04-)
			FOCUS III (11-)
			FUSION (02-)
			GRAND C-MAX (10)
			KA (96-08)
			MAVERICK (01-)
			MONDEO I (93-96)
			MONDEO II (96-0)
			MONDEO IV (07-)
			ORION III (90-9)
			P 100 (87-92)
			PUMA (97-02)
			STREET KA (03-0)
			TOURNEO Connect
			TRANSIT CONNECT
		FORD USA	ESCAPE (01-07)
		HUMMER	HUMMER H3 (05-)
		MAZDA	2 (03-)
			3 (00-09)
			6 (02-07)
			6 (07-)
			121 III (96-03)
			TRIBUTE (00-08)
		MORGAN	FOUR FOUR (68-)
			PLUS FOUR (85-)
		OPEL	ANTARA (06-)
			ASTRA G (98-09)
			SPEEDSTER (00-)
			VECTRA B (95-03)
			VECTRA C (02-)
			ZAFIRA A (99-05)
		RENAULT	19 I (88-92)
		SUZUKI	GRAND VITARA (0)
		VAUXHALL	ANTARA (06-)
			ASTRA IV (G) (9)
			SPEEDSTER (VX22)
			VECTRA I (B) (9)
			VECTRA II (C) ()
			ZAFIRA I (A) (9)
		VOLVO	C30 (06-12)
			S40 II (04-)
			V50 (04-)
		WESTFIELD	130 (97-)
			ZE (93-97)
U22ETR	-	ALFA ROMEO	147 (00-10)
U24ES-N	-	FERRARI	F40 (88-92)
VCH20	IXEH22TT	MAZDA	2 (14-)
			3 (13-)
			6 (12-)
			CX-3 (15-)
			CX-5 (11-)
			MX-5 IV (15-)
VFK16	IK16TT	MAZDA	2 (07-)

DENSO P/N	TT	MAKE	MODEL
VFK16	IK16TT		DEMIO (98-03)
<i>continued</i>			VERISA (04-)
		MITSUBISHI	DELICA (07-)
		TOYOTA	AQUA (11-)
			SOLUNA Vios (02)
VFK20F	IK20TT	CITROËN	C4 Aircross (12)
			C-CROSSER (07-)
		HONDA	CITY (08-)
			CR-Z (10-)
			JAZZ III (08-)
		MITSUBISHI	OUTLANDER II (0)
			PAJERO IV (06-)
		PEUGEOT	4007 (07-)
			4008 (12-)
VFKH16	IKH16TT	CITROËN	C4 Aircross (12)
		HYUNDAI	EQUUS
		MITSUBISHI	ASX (10-)
			COLT VI (04-)
			LANGER (07-)
		NISSAN	JUKE (10-)
		TOYOTA	ALLION II (07-)
			AURIS (06-)
			AURIS (12-)
			COROLLA (E14, E)
			COROLLA (E16) ()
			COROLLA Rumion
			COROLLA Verso ()
			PORTE II (12-)
			PREMIO (07-)
			RACTIS (05-10)
			SPADE (12-)
			VERSO S (10-)
			YARIS (10-)
VFKH20	IKH20TT	HONDA	INSIGHT (09-)
			JAZZ III (08-)
		HYUNDAI	GENESIS (08-)
		VOLVO	S60 II (10-)
			S80 II (06-)
			V60 (10-)
			V70 III (07-)
			XC60 (08-)
			XC70 II (07-)
			XC90 I (02-)
VFXEH20	IXEH20TT	NISSAN	MICRA IV (10-)
			SERENA (05-)
VFXEH22	IXEH22TT	INFINITI	EX (08-)
			FX (03-)
			M (10-)
			M35 (05-)
			QX70 (13-)
		MAZDA	CX-5 (11-)
		MERCEDES-BENZ	C-CLASS (204) ()
			C-CLASS Coupe ()
			CLK (209) (02-1
			CLS (218) (11-)
			CLS (C219) (04-
			E-CLASS (211) ()
			M-CLASS (W164)
			R-CLASS (251) ()
			S-CLASS (W221)
			S-CLASS Coupe ()
			SL (R230) (01-1
		NISSAN	350 Z (02-)
			ELGRAND (10-)
			MURANO (07-)
			PATROL III (10-
			TEANA (08-)
		SUBARU	FORESTER (08-)
			FORESTER (13-)
			IMPREZA (11-)
			XV (12-)

Spark & Glow Plugs

Buyers Guide

DENSO P/N	TT	MAKE	MODEL	
VK16	-	BMW	7 (E38) (94-01)	
			8 (E31) (90-99)	
			FIAT	PALIO (96-)
		MAZDA	626 V (97-02)	
			XEDOS 9 (93-02)	
		MITSUBISHI	GALUE (96-)	
		NISSAN	SKYLINE (R34) (
		ROLLS-ROYCE	SILVER Seraph (
		SEAT	ALHAMBRA (7V) (
			LEON (1M) (99-0	
		VAUXHALL	SIGNUM (02-08)	
			VECTRA II (C) (
		VK20	IK20TT	AUDI
A5 (8T, 8F) (07				
A6 (4G, C7) (10				
A7 (4GA) (10-)				
Q5 (8R) (08-)				
BMW	1 (E81, E87) (0			
	1 (E82, E88) (0			
	3 (E46) (98-05)			
	3 (E90, E91) (0			
	3 (E92, E93) (0			
	5 (E60, E61) (0			
	6 (E63, E64) (0			
	7 (E65, E66) (0			
	X1 (E84) (09-)			
	X3 (E83) (04-)			
	X5 (E53) (00-)			
	X5 (E70) (07-13			
	Z4 (E85, E86) (
	CHEVROLET			CRUZE (00-08)
CRUZE (09-)				
ORLANDO (11-)				
DACIA	DUSTER (10-)			
FIAT	SEDICI (06-)			
FORD	GALAXY (95-06)			
	ORION II (85-90			
	SCORPIO II (94-			
	TRANSIT (00-06)			
JEEP	GRAND CHEROKEE			
MAYBACH	MAYBACH (02-12)			
MERCEDES-BENZ	C-CLASS (202) (
	CLK (208) (97-0			
	E-CLASS (210) (
MORGAN	AERO 8 (00-)			
	AERO (12-)			
	AERO Supersport			
	PLUS EIGHT (68-			
OPEL	ANTARA (06-)			
	ZAFIRA C (11-)			
PROTON	PERSONA 300 (96			
RENAULT	SCÉNIC I (99-03			
SUBARU	JUSTY II (95-03			
	JUSTY III (03-)			
	LEGACY IV (03-)			
	LEGACY V (09-)			
	OUTBACK (03-09)			
	OUTBACK (09-)			
	SUZUKI			GRAND VITARA (9
		GRAND VITARA (0		
IGNIS II (03-)				
JIMNY (98-)				
LIANA (01-)				
SWIFT III (05-)				
SX4 (06-)				
WIESMANN	GT MF4 (03-)			
	MF4 Roadster (0			
VK20G	-	AUDI	A1 (8X) (10-)	
			A3 (8P) (03-13)	
			A3 Convertible	
		HONDA	LIFE (03-)	

DENSO P/N	TT	MAKE	MODEL	
VK20G	-	MAZDA	626 V (97-02)	
			SEAT	ALTEA (XL) (5P)
				IBIZA V (6J) (0
		LEON (1P) (05-)		
		TOLEDO IV (KG3)		
		SKODA	FABIA (06-14)	
			OCTAVIA (1Z) (0	
			RAPID (HN) (12-	
			SUPERB (3T) (08	
			YETI (5L) (09-)	
VW	BEETLE (5C) (11			
	EOS (1F) (06-)			
	GOLF PLUS (5M,			
	GOLF V (1K) (03			
	GOLF VI (5K, 51			
	JETTA III (1K2)			
	JETTA IV (162)			
	PASSAT (3C) (05			
	PASSAT (362, 36			
	POLO (6R, 6C) (
SCIROCCO (137)				
TIGUAN (5N) (07				
TOURAN (1T1, 1T				
TOURAN (1T3) (1				
VK20T	IK20TT	CHEVROLET	AVEO (T300) (11	
			CAPTIVA (06-)	
			EVANDA (05-)	
			REZZO (05-)	
		OPEL	ADAM (12-)	
			CORSA D (06-)	
		VAUXHALL	ADAM (12-)	
			CORSA III (D) (
		VOLVO	V70 II (00-07)	
			VW	CADDY III (2K,
TOURAN (1T1, 1T				
VK20Y	-	DAIHATSU	COPEN (03-)	
			MOVE (02-)	
			TERIOS (97-)	
			YRV (01-)	
		MERCEDES-BENZ	CLK (208) (97-0	
			S-CLASS (W220)	
			S-CLASS (W221)	
			S-CLASS Coupe (
			SL (R230) (01-1	
		MITSUBISHI	eK (00-)	
PAJERO IV (06-)				
TOPPO (08-)				
TOYOTA	CALDINA (02-07)			
	CAMI (99-05)			
VK22	-	ALPINA	B5 (E60, E61) (
			B7 (E65) (03-08	
		ALPINE	A610 (91-95)	
			AUDI	80 (89, 8A, B3)
		80 (8C, B4) (91		
		90 (89, 8A, B3)		
		100 (4A, C4) (9		
		200 (44) (83-91		
		A3 (8P) (03-13)		
		A3 Convertible		
A4 (8D, B5) (94				
A4 (8E, B7) (04				
A4 (8K, B8) (07				
A4 Allroad (8KH				
A4 Convertible				
A5 (8T, 8F) (07				
A6 (4A, C4) (94				
A6 (4B, C5) (97				
A6 (4F, C6) (04				
A6 (4G, C7) (10				
A6 Allroad (4FH				
A8 (4E) (02-10)				

DENSO P/N	TT	MAKE	MODEL
VK22	-		CABRIOLET (8G7)
<i>continued</i>			COUPE (89, 8B)
			Q3 (8U) (11-)
			Q5 (8R) (08-)
			Q7 (4L) (06-)
			QUATTRO (85) (8
			R8 (07-)
			TT (8J) (06-14)
		CATERHAM	SUPER SEVEN (80
		CITROËN	AX (86-98)
			BX (82-94)
			XM (89-94)
		FIAT	PALIO (96-)
			PUNTO (93-00)
			UNO (83-00)
		FORD	ESCORT V (90-94
			ESCORT VII (95-
			SHUTTLE (94-04)
		HONDA	
		JAGUAR	XJ (94-97)
		KTM	X-BOW (08-)
		LANCIA	DEDRA (89-99)
			DELTA II (93-99
			THEMA (84-94)
		LOTUS	EXIGE (00-12)
		MINI	MINI (R50, R53)
			MINI Convertibl
		NISSAN	200 SX (93-99)
		PEUGEOT	106 I (91-96)
			205 I (83-94)
			205 II (87-98)
			309 II (89-93)
			405 I (87-93)
		PORSCHE	911 (964) (88-9
			911 (993) (93-9
			911 (996) (97-0
			911 (997) (04-1
			BOXSTER (987) (
			CAYENNE (955) (
			CAYMAN (987) (0
		RENAULT	CLIO III (05-)
			LAGUNA II (01-)
			LAGUNA III (07-
			MEGANE II (02-)
			MEGANE III (08-
			SAFRANE I (92-9
			TWINGO II (07-)
			WIND (10-)
		SAAB	9-3 (02-)
			9-5 (97-)
			900 I (78-94)
		SEAT	ALHAMBRA (710)
			ALTEA (XL) (5P)
			CORDOBA (6K1) (
			EXEO (3R) (08-)
			IBIZA II (6K1)
			LEON (1P) (05-)
			TOLEDO I (1L) (
			TOLEDO III (5P)
		SKODA	OCTAVIA (1Z) (0
			SUPERB (3T) (08
			YETI (5L) (09-)
		SPYKER	C8 (00-)
			C8 Aileron (10-
		SUBARU	IMPREZA (00-)
			LEGACY II (94-9
		TOYOTA	SUPRA (93-02)
		VOLVO	850 (91-97)
			V70 I (96-00)
		VW	AMAROK (10-)
			BEETLE (5C) (11
			CC (358) (11-)

DENSO P/N	TT	MAKE	MODEL
VK22	-		CORRADO (53) (
<i>continued</i>			EOS (1F) (06-)
			GOLF II (19, 1G
			GOLF III (1H, 1
			GOLF V (1K) (03
			GOLF VI (5K, 51
			JETTA II (19, 1
			JETTA III (1K2)
			JETTA IV (162)
			MULTIVAN V (7H,
			PASSAT (3A2, 35
			PASSAT (3C) (05
			PASSAT (362, 36
			PASSAT CC (357)
			SCIROCCO (53B)
			SCIROCCO (137)
			SHARAN (7N) (10
			TIGUAN (5N) (07
			TRANSPORTER V (
VK22G	-	FORD	GALAXY (95-06)
			TRANSIT (94-00)
			TRANSIT TOURNEO
		HONDA	CIVIC VII (00-0
			CIVIC VIII Hatc
			INTEGRA (93-01)
			INTEGRA (02-)
			S2000 (99-)
		PORSCHE	911 (997) (04-1
		SAAB	9-5 (97-)
		TOYOTA	ALTEZZA (99-05)
VKA16	-	AUDI	A3 (8P) (03-13)
			A4 (8E, B6) (00
		MITSUBISHI	PAJERO III (00-
		SEAT	ALTEA (XL) (5P)
			LEON (1P) (05-)
			TOLEDO III (5P)
		SKODA	OCTAVIA (1Z) (0
		VW	EOS (1F) (06-)
			GOLF PLUS (5M,
			GOLF V (1K) (03
			JETTA III (1K2)
			PASSAT (3C) (05
			TOURAN (1T1, 1T
VKA20	-	TOYOTA	NADIA (98-03)
			VISTA (98-03)
			WISH (03-09)
			WISH (09-)
VKB16	-	MITSUBISHI	GALANT VI (96-0
			PAJERO Pinin (9
			SPACE RUNNER (9
			SPACE WAGON (98
VKB20	-	AUDI	A5 (8T, 8F) (07
			A6 (4F, C6) (04
			A6 Allroad (4FH
			A8 (4E) (02-10)
			A8 (4H) (09-)
			Q7 (4L) (06-)
		MITSUBISHI	CARISMA (95-06)
			GALANT VI (96-0
			PAJERO II (90-0
			PAJERO Pinin (9
			SPACE STAR (98-
		TOYOTA	AVENSIS (97-03)
			AVENSIS (03-09)
		VOLVO	S40 I (95-03)
			V40 (95-04)
		VW	TOUAREG (7L) (0
			TOUAREG (7P) (1
VKH16	IKH16TT	CITROËN	C5 I (01-04)
			C5 II (04-)
			C5 III (08-)

Spark & Glow Plugs

Buyers Guide

DENSO P/N	TT	MAKE	MODEL
VKH16	IKH16TT		C6 (05-)
<i>continued</i>			C8 (02-)
		HYUNDAI	GRANDEUR (05-)
			GRANDEUR (11-)
			SANTA FÉ I (00-)
			SANTA FÉ II (06)
		INFINITI	FX (03-)
			G (02-)
			M35 (05-)
			M45 (05-)
			Q45 III (01-)
		KIA	MAGENTIS (05-)
		LANCIA	PHEDRA (02-10)
		MITSUBISHI	GALIE (96-)
			VIEWT (K12) (05)
		NISSAN	350 Z (02-)
			ALTIMA (01-06)
			MURANO (07-)
			PATHFINDER (97-)
			QUEST (03-)
			SKYLINE (V35) (
			TEANA (03-08)
			TITAN (03-)
		PEUGEOT	407 (04-)
			607 (00-)
			807 (02-)
		RENAULT	ESPACE IV (02-)
			VEL SATIS (02-)
VKH20	IKH20TT	BMW	1 (E81, E87) (0
			1 (E82, E88) (0
			3 (E90, E91) (0
			3 (E92, E93) (0
			5 (E60, E61) (0
			6 (E63, E64) (0
			7 (E65, E66) (0
			7 (F01, F02, F0
			X1 (E84) (09-)
			X3 (E83) (04-)
			X5 (E70) (07-13
			Z4 (E85, E86) (
			Z4 (E89) (09-)
		HONDA	CIVIC VIII Salo
			INSIGHT (00-06)
		MERCEDES-BENZ	C-CLASS (203) (
			C-CLASS Coupe (
			CLC (CL203) (08
			CLK (209) (02-1
			CLS (C219) (04-
			E-CLASS (211) (
			S-CLASS Coupe (
			SL (R230) (01-1
			SLR (R199) (04-
		MITSUBISHI	COLT VI (04-)
		NISSAN	350 Z (02-)
			MURANO (03-)
			PATHFINDER (05-
			PATROL GR II (9
			TEANA (03-08)
		SUBARU	FORESTER (02-)
			FORESTER (08-)
			IMPREZA (08-)
			LEGACY IV (03-)
			LEGACY V (09-)
			OUTBACK (00-03)
			OUTBACK (03-09)
			OUTBACK (09-)
			TRIBECA (05-)
		SUZUKI	GRAND VITARA (0
			KIZASHI (10-)
		VOLVO	V70 III (07-)
VKH20Y	-	FORD	MONDEO IV (07-)

DENSO P/N	TT	MAKE	MODEL
VKH20Y	-	LAND ROVER	FREELANDER II (
<i>continued</i>		MERCEDES-BENZ	G-CLASS (W463)
			SL (R230) (01-1
			SLK (R171) (04-
		SUBARU	FORESTER (02-)
			IMPREZA (08-)
			IMPREZA (11-)
			LEGACY V (09-)
			TRIBECA (05-)
		VOLVO	S60 I (00-10)
			S80 II (06-)
			V70 II (00-07)
			V70 III (07-)
VKH22	-	AUDI	A3 (8P) (03-13)
			TT (8J) (06-14)
		FORD	FOCUS II (04-)
			MONDEO IV (07-)
		LOTUS	EVORA (09-)
		MITSUBISHI	LANCER EVO (92-
		SUBARU	FORESTER (02-)
			IMPREZA (00-)
			IMPREZA (08-)
			LEGACY IV (03-)
			LEGACY V (09-)
		VOLVO	C30 (06-12)
			C70 II (06-)
			S40 II (04-)
			S80 II (06-)
			V50 (04-)
			V70 II (00-07)
			V70 III (07-)
			XC60 (08-)
			XC70 II (07-)
			XC90 I (02-)
VQ16	IQ16TT	CHEVROLET	MATIZ (05-)
VQ20	IQ20TT	LADA	KALINA (04-)
			PRIORA (2170, 2
		NISSAN	SKYLINE (R34) (
VQ22	-	ALFA ROMEO	155 (92-97)
		ASTON MARTIN	DB7 (94-03)
		CATERHAM	21 (94-)
		CITROËN	AX (86-98)
			BX (82-94)
			VISA (78-91)
			XM (89-94)
		FIAT	ELBA (86-96)
			PUNTO (93-00)
			SCUDO (96-06)
			TEMPRA (90-96)
			TIPO (87-95)
		FORD	ESCORT III (80-
			ESCORT IV (85-9
			FIESTA I (76-86
			ORION I (83-86)
			ORION II (85-90
		LANCIA	DEDRA (89-99)
		NISSAN	300 ZX (84-90)
		PEUGEOT	205 II (87-98)
			306 (93-02)
			309 I (85-89)
			605 (89-99)
			EXPERT (96-)
		SAAB	9-3 (98-03)
			9-5 (97-)
			900 I (78-94)
			900 II (93-98)
			9000 (84-98)
		SEAT	IBIZA I (84-93)
			MALAGA (84-93)
			RONDA (82-88)
VT16	IT16TT	MAZDA	5 (05-)

Spark & Glow Plugs

Buyers Guide

DENSO P/N	TT	MAKE	MODEL
VT16	IT16TT		6 (02-07)
<i>continued</i>			6 (07-)
			MPV II (99-06)
			MX-5 III (05-)
			TRIBUTE (00-08)
		SAAB	9-7X (05-)
VT20	IT20TT	FORD	FIESTA V (01-08)
			FOCUS C-MAX (03
			FOCUS I (98-05)
			FOCUS II (04-)
			MONDEO III (00-
			MONDEO IV (07-)
			TRANSIT (06-)
		VOLVO	S40 II (04-)
			V50 (04-)
VW20	IW20TT	LADA	NIVA II (2123)
		MITSUBISHI	LANCER VII (03-
			OUTLANDER I (03
VW22	-	ALFA ROMEO	33 (83-93)
			33 (90-94)
			75 (85-92)
			90 (84-87)
			145
			155 (92-97)
			164 (87-98)
			166 (98-07)
			ALFASUD (72-89)
			ALFETTA (74-84)
			ALFETTA GT (74-
			AR 6 (79-89)
			ARNA (83-86)
			GIULIA (62-78)
			GIULIETTA (77-8
			GT (63-77)
			GTV (78-87)
			GTV (95-05)
			RZ (92-94)
			SPIDER (66-77)
			SPIDER (71-93)
			SPIDER (94-05)
			SZ (88-94)
		ASTON MARTIN	V8 (69-93)
			ZAGATO (86-89)
		AUDI	80 (81, 85, B2)
			100 (43, C2) (7
			200 (43) (79-82
			COUPE (81, 85)
			QUATTRO (85) (8
		AUTOBIANCHI	A 112 (69-85)
		BEDFORD	ASTRA VAN (82-9
			ASTRAMAX (85-90
		FERRARI	400 i (79-85)
			DINO GT4 (74-80
		FIAT	124 (66-85)
			125 (67-74)
			126 (72-00)
			COUPE (93-00)
			CROMA (85-96)
			FIORINO (80-93)
			FIORINO (88-01)
			REGATA (83-90)
			RITMO (78-88)
			RITMO Bertone (
			TEMPRA (90-96)
			TIPO (87-95)
			UNO (83-00)
		FORD	ESCORT II (73-8
			GRANADA (72-85)
			SCORPIO I (85-9
			SIERRA (82-87)
			SIERRA (87-93)

DENSO P/N	TT	MAKE	MODEL
VW22	-	FSO	POLONEZ I (77-9
<i>continued</i>			POLONEZ II (88-
			POLONEZ III (92
		INNOCENTI	ELBA (91-96)
			KORAL (90-92)
		LANCIA	DEDRA (89-99)
			DELTA I (79-94)
			DELTA II (93-99)
			GAMMA (81-84)
			PRISMA (83-92)
			THEMA (84-94)
		LOTUS	ECLAT (75-86)
			ELITE (74-82)
			ESPRIT S2 (75-8
		MASERATI	420
			BITURBO (81-94)
		MERCEDES-BENZ	SL (W121) (55-6
		MITSUBISHI	CARISMA (95-06)
			COLT II (84-88)
			ECLIPSE II (94-
			L 300 (86-)
			LANCER EVO (92-
			OUTLANDER I (03
		MOSKOVICH	407 (58-)
			2140 (78-83)
			21412 (89-01)
			ASLK 2137 (76-)
			ASLK 2140 (76-)
		PEUGEOT	505 (79-95)
		PORSCHE	911 (901, 911)
			924 (75-89)
			944 (81-91)
		RENAULT	9 (81-89)
			11 (83-88)
			19 I (88-92)
			19 II (92-01)
			21 (86-95)
			CLIO I (90-98)
			TRAFIC (80-89)
			TRAFIC (89-01)
		SAAB	900 I (78-94)
		SEAT	131 (78-86)
			IBIZA III (6K2)
			RONDA (82-88)
			TOLEDO I (1L) (
		SUBARU	1800 XT COUPE (
			LEONE II (84-94
		TOFAS	DOGAN (76-02)
			KARTAL (91-)
			SAHIN (80-03)
		TVR	280 (83-86)
			390 (84-89)
			420 (85-89)
		VOLVO	240 (74-93)
			440 (88-96)
			460 (88-96)
			480 (86-96)
		VW	DERBY (86C, 80)
			GOLF I (17, 155
			JETTA I (16) (7
			PASSAT (32B) (8
			POLO (86C, 80)
			SANTANA (81-85)
			SCIROCCO (53) (
			SCIROCCO (53B)
			TRANSPORTER III
VXEBH27	-	SUBARU	BRZ (12-)
		TOYOTA	GT 86 (12-)
VXHUC22G	-	AUDI	Q7 (4L) (06-)
		HONDA	ACCORD VIII (08
			INSPIRE (07-12)

Spark & Glow Plugs

Buyers Guide

DENSO P/N	TT	MAKE	MODEL
VXHUC22G	-	PORSCHE	CAYENNE (955) (
<i>continued</i>		VW	PASSAT (3C) (05 PHAETON (3D) (0 TOUAREG (7L) (0 TOUAREG (7P) (1
VXU22	-	ALFA ROMEO	MITO (08-)
		AUDI	A3 (8P) (03-13)
		BMW	3 (E36) (90-00) 5 (E34) (87-97) Z3 (E36) (95-03
		CHEVROLET	AVEO (T250, T25 COBALT (11-) SPARK (10-) SPIN (12-)
		CHRYSLER	YPSILON (846) (
		DAEWOO	GENTRA (13-)
		FAW	V5 (12-)
		FIAT	500 (C) (07-) 500L (12-) BRAVO II (06-) DOBLO (01-) DOBLO (10-) FIORINO (07-) GRANDE PUNTO (0 IDEA (03-) LINEA (07-) PANDA (03-) PANDA (12-) PUNTO (99-) PUNTO (12-) PUNTO EVO (08-1 QUBO (08-) SEICENTO (98-10 STILO (01-08)
		FORD	KA (08-)
		LANCIA	MUSA (04-) YPSILON (843) (
			YPSILON (846) (
		MITSUBISHI	DELICA (07-) PAJERO Mini (94 TOPPO (90-03)
		NISSAN	PIXO (09-)
		OPEL	AGILA (08-) COMBO (12-)
		PORSCHE	911 (996) (97-0 911 (997) (04-1
		SUZUKI	ALTO IV (02-08) ALTO V (09-) CAPPUCINO (92-9 SOLIO (11-) SPLASH (08-) SWIFT IV (10-) WAGON R+ (98-00
		VAUXHALL	AGILA II (B) (0
		WIESMANN	MF3 Roadster (9
VXU22I	-	DAIHATSU	BEGO (05-) MATERIA (06-) SIRION (05-) TERIOS (05-)
		PERODUA	ALZA (09-)
		TOYOTA	RUSH (06-)
VXU24	-	BMW	3 (E46) (98-05) Z3 (E36) (95-03 Z4 (E85, E86) (
		CHEVROLET	CRUZE (09-)
		FIAT	BRAVA (95-02) BRAVO I (95-01) IDEA (03-) MAREA (96-07) PALIO (96-) PUNTO (93-00)

DENSO P/N	TT	MAKE	MODEL
VXU24	-		PUNTO (99-)
<i>continued</i>			SIENA (96-) STILO (01-08)
		LANCIA	Y (95-03)
		MASERATI	BITURBO (81-94) SHAMAL (89-95)
		TVR	CERBERA (96-03)
		WIESMANN	MF3 Roadster (9
VXUH20i	-	HYUNDAI	i10 (07-) i10 (13-) i20 (08-)
VXUH20I	-	HYUNDAI	i30 (11-) i40 (11-) ix35 (09-) VELOSTER (11-)
		KIA	CARENS IV (13-) CEED (12-)
VXUH20i	-	KIA	PICANTO (11-)
VXUH20I	-	KIA	PRO CEED (13-)
VXUH20i	-	KIA	RIO III (11-)
VXUH20I	-	KIA	SOUL I (09-) SOUL II (14-) SPORTAGE III (1
		MITSUBISHI	OUTLANDER III (
		TOYOTA	PIXIS (11-)
VXUH22	-	BMW	1 (F20, F21) (1 3 (F30, F31) (1
		CITROËN	BERLINGO (B9) (
			C3 II (09-) C3 Picasso (09- C4 (Grand) Pica C4 (Grand) Pica C4 Coupe (04-) C4 I (LC) (04-) C4 II (B7) (09- C5 III (08-) DS3 (09-) DS4 (11-) DS5 (11-)
		HYUNDAI	ACCENT ELANTRA (05-11) ELANTRA (11-) i10 (07-) i20 (08-) i30 (07-12) i30 (11-) ix20 (10-)
		KIA	CARENS III (06- CEED (06-) CEED (12-) CERATO (09-) PRO CEED (08-) RIO III (11-) SOUL I (09-) VENGA (10-)
		MERCEDES-BENZ	C-CLASS (203) (
			C-CLASS (204) (
			C-CLASS Coupe (
			C-CLASS Coupe (
			CLC (CL203) (08
			CLK (209) (02-1
			CLS (218) (11-)
			CLS (C219) (04- E-CLASS (211) (
			E-CLASS (212) (
			E-CLASS Coupe
			GL-CLASS (X164)
			GLK (X204) (08- M-CLASS (W164) M-CLASS (W166) R-CLASS (251) (

DENSO P/N	TT	MAKE	MODEL
VXUH22	-		S-CLASS (W221)
<i>continued</i>			S-CLASS Coupe (
			SL (R230) (01-1
			SLK (R171) (04-
			SLK (R172) (11-
			SPRINTER 3,5 (9
			SPRINTER 3-t (9
			SPRINTER 4,6-t
			SPRINTER 5-t (9
			VIANO (W639) (0
			VITO
		MINI	MINI (R56) (06-
			MINI Clubman (R
			MINI Convertibl
			MINI Countryman
			MINI Coupe (R58
			MINI Paceman (R
			MINI Roadster (
		MITSUBISHI	i-MiEV (06-)
			OUTLANDER II (0
		PEUGEOT	207 (06-)
			208 (12-)
			308 I (07-)
			508 (10-)
			2008 (13-)
			3008 (09-)
			5008 (09-)
			PARTNER
			RCZ (10-)
		SMART	FORTWO (451) (0
VXUH221	-	AUDI	A8 (4H) (09-)
		CITROËN	C3 II (09-)
			C-ELYSEE (12-)
			DS3 (09-)
		HYUNDAI	GENESIS (08-)
			i40 (11-)
			ix35 (09-)
		KIA	CARENS IV (13-)
			OPTIMA (11-)
			SPORTAGE III (1
		MERCEDES-BENZ	C-CLASS (204) (
			CLS (C219) (04-
			E-CLASS (212) (
			E-CLASS Coupe
		PEUGEOT	208 (12-)
			301 (12-)
			2008 (13-)
VXUHC22G	-	AUDI	Q7 (4L) (06-)
		DODGE	CHARGER (11-)
		HONDA	ACCORD VIII (08
			INSPIRE (07-12)
			LEGEND IV (06-)
			ODYSSEY (02-)
		PORSCHE	CAYENNE (955) (
		VW	PASSAT (3C) (05
			PHAETON (3D) (0
			TOUAREG (7L) (0
			TOUAREG (7P) (1
W14EPR-U	IW16TT	NISSAN	CHERRY I (E10)
			CHERRY II (N10)
			DATSUN 100 A (7
			DATSUN 120 (74-
			DATSUN 120 Y (6
			SUNNY (70-82)
		RENAULT	19 II (92-01)
			CLIO I (90-98)
			FUEGO (80-85)
			RAPID (85-98)
			SUPER 5 (84-96)
W14EXR-U	IW16TT	TOYOTA	COROLLA (KE) (7
			CRESSIDA (80-93

DENSO P/N	TT	MAKE	MODEL
W14EXR-U	IW16TT		LAND CRUISER (J
<i>continued</i>			STARLET (P8) (8
			SUPRA (81-85)
W14EX-U	IW16TT	TOYOTA	COROLLA (E7) (7
			LAND CRUISER (J
			LAND CRUISER (J
W16EPB10	W16TT	AUDI	80 (81, 85, B2)
			80 (89, 8A, B3)
			100 (44, C3) (8
		VW	LUPO (6X, 6E) (
			PASSAT (32B) (8
			SANTANA (81-85)
			VENTO (1H2) (91
W16EPR-U	W16TT	ARO	10 (80-06)
			SPARTANA (99-06
		ASIA MOTORS	ROCSTA (89-99)
		AUSTIN	METRO (80-90)
		BENTLEY	CONTINENTAL (84
			CONTINENTAL (91
			TURBO R (88-98)
		BMW	02 (E6, E10) (6
			3 (E21) (75-84)
			3 (E30) (82-94)
			6 (E24) (76-90)
			7 (E23) (77-86)
			1500-2000 (62-7
			1600 GT (67-69)
		CHEVROLET	KALOS (05-)
		CHRYSLER	LE BARON (86-96
			VOYAGER (90-95)
			VOYAGER (95-01)
		DACIA	NOVA (96-03)
		DAEWOO	GENTRA (02-05)
			KALOS (02-)
			MATIZ (98-)
			TICO (95-00)
		DAIMLER	2.8 - 5.3 (69-9
			COUPE (73-77)
			LANDAULETTE (74
			LIMOUSINE (68-9
		DODGE	CARAVAN (95-02)
		FIAT	DUCATO (82-90)
			DUCATO (89-94)
		GAZ	GAZELLE (93-01)
			VOLGA (93-10)
		HONDA	PRELUDE I (78-8
			QUINTET (80-84)
		INNOCENTI	MINI (74-95)
		JAGUAR	E-TYPE 2+2 (66-
			E-TYPE (61-75)
			Mk X (61-70)
			XJ (68-93)
		JEEP	CHEROKEE (80-86
		LAND ROVER	88
			90
			DEFENDER (90-)
			RANGE ROVER I (
		LDV	SHERPA (74-89)
		MARUTI	800 (91-06)
		MAZDA	121 I (87-90)
			121 II (90-97)
			323 C IV (89-00
			323 I (77-86)
			323 II (80-89)
			323 S IV (89-94
			616 (73-78)
			626 I (79-82)
			626 II (82-87)
			626 III (87-97)
			B-SERIE (77-82)
			B-SERIE (85-99)

DENSO P/N	TT	MAKE	MODEL
W16EPR-U	W16TT		E-SERIE (80-84)
<i>continued</i>		MG	MIDGET (64-79)
		MITSUBISHI	COLT I (78-84)
			COLT V (95-03)
			GALANT II (80-8
			GALANT III (84-
			L 300 (80-87)
			L 300 (86-)
			LANCER I (79-83
			LANCER II (83-8
			PAJERO I (82-91
		NISSAN	CABSTAR (92-11)
			CHERRY II (N10)
			CHERRY III (N12
			LAUREL (77-83)
			LAUREL (81-85)
			LAUREL (84-89)
			MICRA I (82-92)
			PATROL (84-96)
			PATROL GR I (87
			PICK UP (80-86)
			PICK UP (85-98)
			SUNNY I (82-90)
			SUNNY II (86-91
			TERRANO I (87-9
			URVAN (81-98)
			VANETTE (81-87)
			VANETTE (86-95)
		OPEL	ASCONA C (81-88
			CALIBRA (90-97)
			COMBO (94-01)
			COMMODORE C (78
			CORSA A (82-93)
			CORSA B (93-00)
			OMEGA A (86-94)
			VECTRA A (88-95
		PROTON	JUMBUCK (02-)
			SATRIA (96-)
			WIRA (00-)
		RELIANT	KITTEN (75-83)
		RENAULT	11 (83-88)
			16 (65-80)
			19 I (88-92)
			19 II (92-01)
			CLIO I (90-98)
			ESPACE III (96-
			MEGANE I (96-03
			RAPID (85-98)
		ROVER	MINI-Moke (86-)
		SUZUKI	ALTO II (86-93)
			CARRY (80-85)
			LJ 80 (80-84)
			SAMURAI (88-04)
			SJ 410 (81-88)
			SJ 413 (84-90)
			SUPER CARRY (85
			VITARA (88-99)
		TRIUMPH	2000 (68-77)
			2500 (74-77)
			SPITFIRE (62-80
			STAG (70-77)
		VAUXHALL	CALIBRA (90-97)
			CARLTON III (86
			CAVALIER II (81
			CAVALIER III (8
			CORSA I (B) (93
			RASCAL (86-93)
		VOLVO	340-360 (75-91)
		VW	CADDY I (14) (8
			GOLF I (17, 155
			JETTA I (16) (7

DENSO P/N	TT	MAKE	MODEL
W16EPR-U	W16TT		PASSAT (3A2, 35
<i>continued</i>			PASSAT (32B) (8
		ZASTAVA	YUGO (80-95)
W16EPR-U11	W16TT	CHEVROLET	AVEO (T250, T25
			SPARK (00-04)
			SPARK (05-)
		CHRYSLER	LE BARON (86-96
			VOYAGER (90-95)
		DAEWOO	TICO (95-00)
		KIA	AVELLA (95-01)
			PRIDE (90-)
			SEPHIA (93-97)
		MAZDA	121 I (87-90)
			323 S IV (89-94
			626 II (82-87)
			929 III (87-91)
		MITSUBISHI	COLT IV (92-96)
			COLT V (95-03)
			LANCER IV (88-9
			LANCER V (91-03
			LANCER VI (95-0
			PAJERO I (82-91
			PAJERO II (90-0
		NISSAN	BLUEBIRD (85-92
			CHERRY II (N10)
			SUNNY I (82-90)
			SUNNY II (86-91
		PROTON	PERSONA 400 (94
W16EP-U	W16TT	BMW	3 (E21) (75-84)
			3 (E30) (82-94)
			5 (E12) (72-81)
			5 (E28) (81-87)
			6 (E24) (76-90)
		MERCEDES-BENZ	Saloon (W123) (
		MITSUBISHI	COLT III (88-92
		NISSAN	PICK UP (85-98)
		RENAULT	19 I (88-92)
			19 II (92-01)
			TRAFIC (80-89)
			TWINGO I (93-)
		SUZUKI	SUPER CARRY (85
		VW	CADDY I (14) (8
			GOLF I (17, 155
			JETTA I (16) (7
			SCIROCCO (53) (
			SCIROCCO (53B)
W16ESR-U	-	LAND ROVER	90
		VW	TRANSPORTER II
			TRANSPORTER III
W16ETR-S	W16TT	AUDI	80 (8C, B4) (91
			90 (89, 8A, B3)
			100 (44, C3) (8
			100 (4A, C4) (9
			A6 (4A, C4) (94
			CABRIOLET (8G7)
			COUPE (81, 85)
			COUPE (89, 8B)
		VW	GOLF III (1H, 1
			GOLF IV (1J, 1E
			PASSAT (3A2, 35
			TRANSPORTER IV
W16EXR-U	W16TT	DAIHATSU	CHARADE I (77-8
			CHARADE II (83-
			CHARADE III (87
			CHARADE IV (93-
			CHARMANT (81-87
			HIJET (86-90)
			HIJET (92-)
			ROCKY (85-98)
		GEELY	HQ (05-)
		HONDA	ACCORD I (78-83

DENSO P/N	TT	MAKE	MODEL
W16EXR-U	W16TT		ACCORD II (83-8)
<i>continued</i>		LAND ROVER	DEFENDER (90-) RANGE ROVER I () RANGE ROVER II
		MAZDA	323 F IV (87-94) 323 I (77-86) 323 III (85-95) 626 II (82-87) 626 III (87-97) E-SERIE (SD) (8) E-SERIE (SR) (8)
		RENAULT	RAPID (85-98)
		SANTANA	SAMURAI (86-95)
		SUZUKI	ALTO I (82-85) ALTO III (93-02)
		TOYOTA	4 RUNNER (N5) () CAMRY (83-88) CAMRY (86-91) CARIBE (84-03) CARINA (73-83) CARINA II (83-9) CELICA (73-78) CELICA (77-85) CELICA (85-89) COASTER (77-82) COASTER (82-93) COROLLA (E7) (7) COROLLA (E8) (8) COROLLA (E9) (8) COROLLA (KE) (7) COROLLA FX (84-) CORONA (70-87) CRESSIDA (77-81) CRESSIDA (80-93) CRESTA (84-01) DYNA (77-87) HIACE II (83-89) HIACE III (87-0) HILUX I (72-83) HILUX II (83-05) LAND CRUISER (J) LAND CRUISER LITEACE (79-86) LITEACE (84-92) LITEACE (92-97) MODELL F (82-90) SPRINTER (82-02) STARLET (P6) (7) STARLET (P8) (8) STARLET 1000 (7) SUPRA (81-85) TERCEL (79-88)
		VW	TARO (89-97)
W16EXR-U11	W16TT	DAEWOO	MATIZ (98-)
		DAIHATSU	CHARADE III (87) CUORE IV (94-99) HIJET (92-) MOVE (94-)
		HONDA	JAZZ I (83-86)
		HYUNDAI	GALLOPER (98-03) H-1 SANTAMO (99-)
		KIA	RIO I (00-05)
		NISSAN	CHERRY III (N12)
		TOYOTA	CAMRY (83-88) COROLLA (E8) (8) COROLLA (E9) (8) COROLLA (E10) () COROLLA (E11) () COROLLA FX (84-) LAND CRUISER (J)

DENSO P/N	TT	MAKE	MODEL
W16EXR-U11	W16TT		SPRINTER (82-02)
<i>continued</i>			STARLET (P7) (8) STARLET (P8) (8) TERCEL (79-88)
W16EXR-U13	W16TT	CHRYSLER	SARATOGA (89-95) VOYAGER (87-90) VOYAGER (90-95) VOYAGER (95-01)
		DODGE	CARAVAN (89-90) CARAVAN (95-02)
		PLYMOUTH	VOYAGER (89-90)
W16EX-U	W16TT	TOYOTA	CARINA (73-83) CELICA (73-78) COROLLA (E7) (7) DYNA 100 (85-95) DYNA 150 (85-88) HIACE I (77-85) HIACE II (83-89) HIACE III (87-0) HILUX II (83-05) MODELL F (82-90) STARLET (P6) (7)
W16FPR-U	-	DAF	55 (67-72) 66 (72-75)
		GAZ	GAZELLE (93-01) VOLGA (72-93) VOLGA (93-10)
		LAND ROVER	RANGE ROVER I ()
		MG	MGB (66-80)
		UAZ	3160 (94-) UAS (66-)
W16FP-U	-	RENAULT	4 (62-93) RODEO 5 (81-87)
W16FSR	-	SKODA	1000 (64-70) 1100 (69-70)
		VW	181 (69-79) 1500, 1600 (61-) KAEFER (47-03) KARMANN GHIA (5)
W16FS-U	-	UAZ	31512 (98-)
		VW	KAEFER (47-03)
W16TT	-	ARO	10 (80-06) SPARTANA (99-06)
		ASIA MOTORS	ROCSTA (89-99)
		AUDI	80 (81, 85, B2) 80 (89, 8A, B3) 80 (8C, B4) (91) 90 (89, 8A, B3) 100 (4A, C3) (8) 100 (4A, C4) (9) A6 (4A, C4) (94) CABRIOLET (8G7) COUPE (81, 85) COUPE (89, 8B)
		AUSTIN	METRO (80-90)
		BENTLEY	CONTINENTAL (84) CONTINENTAL (91) TURBO R (88-98)
		BMW	02 (E6, E10) (6) 3 (E21) (75-84) 3 (E30) (82-94) 5 (E12) (72-81) 5 (E28) (81-87) 5 (E34) (87-97) 6 (E24) (76-90) 7 (E23) (77-86) 7 (E32) (86-94) 1500-2000 (62-7) 1600 GT (67-69) Z1 (88-91)
		CHEVROLET	AVEO (T250, T25)

DENSO P/N	TT	MAKE	MODEL
W16TT	-		KALOS (05-)
<i>continued</i>			SPARK (00-04)
			SPARK (05-)
		CHRYSLER	LE BARON (86-96)
			SARATOGA (89-95)
			VOYAGER (87-90)
			VOYAGER (90-95)
			VOYAGER (95-01)
		DACIA	NOVA (96-03)
		DAEWOO	GENTRA (02-05)
			KALOS (02-)
			MATIZ (98-)
			TICO (95-00)
		DAIHATSU	CHARADE I (77-8
			CHARADE II (83-
			CHARADE III (87
			CHARADE IV (93-
			CHARMANT (81-87
			CUORE IV (94-99
			HIJET (86-90)
			HIJET (92-)
			MOVE (94-)
			ROCKY (85-98)
		DAIMLER	2.8 - 5.3 (69-9
			COUPE (73-77)
			LANDAULETTE (74
			LIMOUSINE (68-9
		DODGE	CARAVAN (89-90)
			CARAVAN (95-02)
		FIAT	DUCATO (82-90)
			DUCATO (89-94)
		GAZ	GAZELLE (93-01)
			VOLGA (93-10)
		GEELY	HQ (05-)
		HONDA	ACCORD I (78-83
			ACCORD II (83-8
			JAZZ I (83-86)
			PRELUDE I (78-8
			QUINTET (80-84)
		HYUNDAI	GALLOPER (98-03
			H-1
			SANTA FÉ I (00-
			SANTAMO (99-)
			SONATA II (88-9
			SONATA III (93-
			SONATA IV (98-0
		INNOCENTI	MINI (74-95)
		JAGUAR	E-TYPE 2+2 (66-
			E-TYPE (61-75)
			Mk X (61-70)
			XJ (68-93)
		JEEP	CHEROKEE (80-86
		KIA	AVELLA (95-01)
			PRIDE (90-)
			RIO I (00-05)
			SEPHIA (93-97)
			SORENTO I (02-)
		LAND ROVER	88
			90
			DEFENDER (90-)
			RANGE ROVER I (
			RANGE ROVER II
		LDV	SHERPA (74-89)
		MARUTI	800 (91-06)
		MAZDA	121 I (87-90)
			121 II (90-97)
			323 C IV (89-00
			323 F IV (87-94
			323 I (77-86)
			323 II (80-89)
			323 III (85-95)

DENSO P/N	TT	MAKE	MODEL
W16TT	-		323 S IV (89-94
<i>continued</i>			616 (73-78)
			626 I (79-82)
			626 II (82-87)
			626 III (87-97)
			929 III (87-91)
			B-SERIE (77-82)
			B-SERIE (85-99)
			E-SERIE (SD) (8
			E-SERIE (SR) (8
			E-SERIE (80-84)
		MERCEDES-BENZ	Saloon (W123) (
		MG	MIDGET (64-79)
		MITSUBISHI	COLT I (78-84)
			COLT III (88-92
			COLT IV (92-96)
			COLT V (95-03)
			GALANT II (80-8
			GALANT III (84-
			L 300 (80-87)
			L 300 (86-)
			LANCER I (79-83
			LANCER II (83-8
			LANCER IV (88-9
			LANCER V (91-03
			LANCER VI (95-0
			PAJERO I (82-91
			PAJERO II (90-0
		NISSAN	BLUEBIRD (85-92
			CABSTAR (92-11)
			CHERRY II (N10)
			CHERRY III (N12
			LAUREL (77-83)
			LAUREL (81-85)
			LAUREL (84-89)
			MICRA I (82-92)
			PATROL (84-96)
			PATROL GR I (87
			PICK UP (80-86)
			PICK UP (85-98)
			SUNNY I (82-90)
			SUNNY II (86-91
			TERRANO I (87-9
			URVAN (81-98)
			VANETTE (81-87)
			VANETTE (86-95)
		OPEL	ASCONA C (81-88
			CALIBRA (90-97)
			COMBO (94-01)
			COMMODORE C (78
			CORSA A (82-93)
			CORSA B (93-00)
			OMEGA A (86-94)
			VECTRA A (88-95
		PLYMOUTH	VOYAGER (89-90)
		PROTON	JUMBUCK (02-)
			PERSONA 400 (94
			SATRIA (96-)
			WIRA (00-)
		RELIANT	KITTEN (75-83)
		RENAULT	11 (83-88)
			16 (65-80)
			19 I (88-92)
			19 II (92-01)
			CLIO I (90-98)
			ESPACE III (96-
			MEGANE I (96-03
			RAPID (85-98)
			TRAFIC (80-89)
			TWINGO I (93-)
		ROVER	MINI-Moke (86-)

DENSO P/N	TT	MAKE	MODEL
W16TT	-	SANTANA	SAMURAI (86-95)
<i>continued</i>		SUZUKI	ALTO I (82-85) ALTO II (86-93) ALTO III (93-02) CARRY (80-85) LJ 80 (80-84) SAMURAI (88-04) SJ 410 (81-88) SJ 413 (84-90) SUPER CARRY (85) VITARA (88-99)
		TOYOTA	4 RUNNER (N5) (CAMRY (83-88) CAMRY (86-91) CARIBE (84-03) CARINA (73-83) CARINA II (83-9 CELICA (73-78) CELICA (77-85) CELICA (85-89) COASTER (77-82) COASTER (82-93) COROLLA (E7) (7 COROLLA (E8) (8 COROLLA (E9) (8 COROLLA (E10) (COROLLA (E11) (COROLLA (KE) (7 COROLLA FX (84- CORONA (70-87) CRESSIDA (77-81 CRESSIDA (80-93 CRESTA (84-01) DYNA 100 (85-95 DYNA 150 (85-88 DYNA (77-87) HIACE I (77-85) HIACE II (83-89 HIACE III (87-0 HILUX I (72-83) HILUX II (83-05 LAND CRUISER (J LAND CRUISER (J LAND CRUISER LITEACE (79-86) LITEACE (84-92) LITEACE (92-97) MODELL F (82-90 SPRINTER (82-02 STARLET (P6) (7 STARLET (P7) (8 STARLET (P8) (8 STARLET 1000 (7 SUPRA (81-85) TERCEL (79-88)
		TRIUMPH	2000 (68-77) 2500 (74-77) SPITFIRE (62-80 STAG (70-77)
		VAUXHALL	CALIBRA (90-97) CARLTON III (86 CAVALIER II (81 CAVALIER III (8 CORSA I (B) (93 RASCAL (86-93)
		VOLVO	340-360 (75-91) 440 (88-96) 460 (88-96) 480 (86-96)
		VW	CADDY I (14) (8 GOLF I (17, 155

DENSO P/N	TT	MAKE	MODEL
W16TT	-		GOLF III (1H, 1
<i>continued</i>			GOLF IV (1J, 1E JETTA I (16) (7 LUPO (6X, 6E) (PASSAT (3A2, 35 PASSAT (32B) (8 SANTANA (81-85) SCIROCCO (53) (SCIROCCO (53B) TARO (89-97) TRANSPORTER IV VENTO (1H2) (91
		ZASTAVA	YUGO (80-95)
W20EPB	W20TT	ALFA ROMEO	155 (92-97) 164 (87-98)
		AUDI	80 (80, 82, B1) 80 (81, 85, B2) 80 (89, 8A, B3) 90 (81, 85, B2) 90 (89, 8A, B3) 100 (43, C2) (7 100 (44, C3) (8 100 (4A, C4) (9 200 (43) (79-82 200 (44) (83-91 COUPE (81, 85) COUPE (89, 8B) QUATTRO (85) (8
		LANCIA	DEDRA (89-99) DELTA I (79-94) THEMA (84-94)
		PEUGEOT	505 (79-95)
		VW	CADDY I (14) (8 GOLF I (17, 155 GOLF II (19, 1G GOLF III (1H, 1 JETTA II (19, 1 PASSAT (3A2, 35 PASSAT (32B) (8 POLO (86C, 80) SANTANA (81-85) SCIROCCO (53B) TRANSPORTER III TRANSPORTER IV
W20EPB-S	W20TT	AUDI	80 (81, 85, B2) 80 (89, 8A, B3) 80 (8C, B4) (91 90 (89, 8A, B3) 100 (44, C3) (8 100 (4A, C4) (9 A6 (4A, C4) (94 CABRIOLET (8G7) COUPE (81, 85) COUPE (89, 8B)
		FIAT	CROMA (85-96) TIPO (87-95)
		LANCIA	DELTA I (79-94) KAPPA (94-01)
		PORSCHE	968 (91-95)
		SEAT	AROSA (6H) (97- CORDOBA (6K1) (CORDOBA (6K2) (IBIZA II (6K1) IBIZA III (6K2) INCA (6K9) (95- TOLEDO I (1L) (SKODA
		SKODA	FELICIA Fun (97 FELICIA I (6U) FELICIA II (6U) OCTAVIA (1U) (9
		VW	CADDY II (9K, 9

DENSO P/N	TT	MAKE	MODEL
W20EPBR-S	W20TT		CORRADO (53I) (
<i>continued</i>			GOLF I (17, 155
			GOLF II (19, 1G
			GOLF III (1H, 1
			GOLF IV (1J, 1E
			JETTA II (19, 1
			LUPO (6X, 6E) (
			PASSAT (3A2, 35
			POLO (6N1) (94-
			POLO (86C, 80)
			POLO Classic (6
			POLO Variant (6
			SCIROCCO (53B)
			SHARAN (7M) (95
			TRANSPORTER III
			TRANSPORTER IV
			VENTO (1H2) (91
W20EPR-S11	W20TT	KIA	JOICE (00-)
W20EPR-U	W20TT	ALFA ROMEO	75 (85-92)
			1750-2000 (68-7
			GIULIA (62-78)
			GT (63-77)
		ASTON MARTIN	DB6 (64-70)
			DBS (66-72)
		AUDI	80 (80, 82, B1)
			80 (81, 85, B2)
			100 (44, C3) (8
			100 (C1) (68-76
			COUPE (81, 85)
		AUSTIN	ALLEGRO (73-84)
			MAESTRO (83-92)
			MAXI (69-82)
			MINI (60-93)
			MONTEGO (84-92)
			PRINCESS (76-82
		AUTOBIANCHI	A 112 (69-85)
			Y10 (85-95)
		BEDFORD	MIDI (84-92)
		BENTLEY	CONTINENTAL (91
			TURBO R (88-98)
		BMW	3 (E21) (75-84)
			3 (E30) (82-94)
			5 (E34) (87-97)
		CHEVROLET	AVEO (T250, T25
			KALOS (05-)
			LANOS (05-)
			NIVA (2121) (02
		CITROËN	GS (70-86)
		DACIA	NOVA (96-03)
		DAEWOO	CIELO (94-98)
			ESPERO (91-99)
			GENTRA (02-05)
			KALOS (02-)
			LACETTI (97-99)
			LANOS (97-)
			NEXIA (95-08)
			NEXIA (08-)
			TACUMA
		FIAT	126 (72-00)
			127 (71-86)
			128 (69-84)
			131 (74-84)
			132 (72-82)
			900 T
			900 T
			ARGENTA (78-86)
			CINQUECENTO (91
			DUCATO (82-90)
			DUNA (87-91)
			FIORINO (77-87)
			FIORINO (80-93)

DENSO P/N	TT	MAKE	MODEL
W20EPR-U	W20TT		FIORINO (88-01)
<i>continued</i>			PANDA (80-04)
			REGATA (83-90)
			RITMO (78-88)
			RITMO Bertone (
			SEICENTO (98-10
			TEMPRA (90-96)
			TIPO (87-95)
			UNO (83-00)
			X 1/9 (73-89)
		FORD	GRANADA (72-85)
		FSO	126P (72-00)
			127P (69-76)
			LANOS (04-08)
		HONDA	CIVIC I (72-84)
			CIVIC II (79-83
		HYUNDAI	H-1
			PONY
			PONY (74-82)
			PONY (85-89)
			S COUPE (90-96)
			STELLAR (83-91)
		INNOCENTI	ELBA (91-96)
		ISUZU	CAMPO (77-91)
			MIDI (88-)
			PICK UP (87-96)
			TROOPER (83-91)
		LADA	110 (95-)
			111 (95-)
			112 (95-)
			1200-1500 (73-8
			1200-1600 (70-9
			KALINA (04-)
			NIVA (2121) (76
			NIVA II (2123)
			NOVA (81-)
			SAMARA (86-)
			TOSCANA (83-12)
		LANCIA	BETA (73-86)
			BETA H.P.E. (76
			BETA Monte Carl
			DEDRA (89-99)
			DELTA I (79-94)
			DELTA II (93-99
			THEMA (84-94)
			TREVI (80-87)
			Y10 (85-95)
		LAND ROVER	DISCOVERY I (89
			RANGE ROVER I (
		LOTUS	ECLAT (75-86)
			ELITE (74-82)
			ESPRIT S2 (75-8
			ESPRIT S3 (80-8
			EXCEL (83-91)
		MAZDA	323 III (85-95)
			626 I (79-82)
			626 II (82-87)
			818 (74-78)
			929 I (79-86)
			929 II (82-87)
			1300 (75-77)
		MERCEDES-BENZ	S-CLASS (W116)
			SL (R107) (71-8
		MG	1300 II (67-70)
			MAESTRO (83-90)
			METRO (82-90)
			MGB (66-80)
			MGC (67-69)
			MONTEGO (84-90)
		MITSUBISHI	COLT I (78-84)
			COLT II (84-88)

DENSO P/N	TT	MAKE	MODEL
W20EPR-U	W20TT		COLT III (88-92)
<i>continued</i>			CORDIA (82-89)
			ECLIPSE I (89-9)
			ECLIPSE II (94-
			GALANT II (80-8
			GALANT III (84-
			GALANT IV (87-9
			GALANT V (92-96
			L 200 (86-96)
			L 300 (86-)
			L 300 (94-00)
			L 400
			LANCER I (79-83
			LANCER III (83-
			LANCER IV (88-9
			MIRAGE (88-91)
			SPACE WAGON (83
			SPACE WAGON (91
		MORGAN	PLUS EIGHT (68-
		MORRIS	MINI (60-81)
		MOSKVICH	21412 (89-01)
		NISSAN	BLUEBIRD (80-86
			BLUEBIRD (83-90
			CEDRIC (83-87)
			CHERRY II (N10)
			CHERRY III (N12
			DATSUN 180 B (7
			LAUREL (77-83)
			LAUREL (81-85)
			PATHFINDER (86-
			PATROL (79-88)
			PRAIRIE (83-88)
			STANZA (81-85)
			SUNNY (70-82)
			SUNNY I (82-90)
			SUNNY II (86-91
			URVAN (81-98)
			VANETTE (81-87)
			VANETTE (86-95)
		OPEL	ASCONA B (75-81
			ASCONA C (81-88
			ASTRA F (91-01)
			CORSA A (82-93)
			KADETT D (79-84
			KADETT E (84-94
			MANTA A (70-75)
			MANTA B (75-88)
			OMEGA A (86-94)
			REKORD E (77-86
			VECTRA A (88-95
		PEUGEOT	504 (68-89)
			J5 (81-90)
			J7 (68-80)
		PIAGGIO	PORTER (93-)
		PININFARINA	SPIDEREUROPA (8
		PORSCHE	924 (75-89)
			944 (81-91)
		PROTON	AEROBACK (88-96
			PERSONA 300 (96
			SAGA I (88-07)
			SALOON (91-96)
		RENAULT	4 (62-93)
			5 (72-85)
			6 (69-87)
			8 (62-72)
			9 (81-89)
			10 (66-72)
			11 (83-88)
			12 (69-80)
			16 (65-80)
			18 (78-93)

DENSO P/N	TT	MAKE	MODEL
W20EPR-U	W20TT		19 I (88-92)
<i>continued</i>			19 II (92-01)
			20 (75-83)
			21 (86-95)
			CLIO I (90-98)
			ESTAFETTE (62-8
			LAGUNA I (93-01
			MASTER I (80-98
			MEGANE I (96-03
			RAPID (85-98)
			RODEO 6 (70-81)
			SUPER 5 (84-96)
			TRAFIC (80-89)
			TRAFIC (89-01)
		RILEY	ELF III (63-68)
		ROVER	MINI (91-01)
			MONTEGO (84-95)
		SANTANA	SAMURAI (86-95)
		SEAT	FURA (82-86)
			IBIZA I (84-93)
			MARBELLA (86-98
			PANDA (80-86)
			TERRA (87-96)
		SUBARU	LEONE II (84-94
			MV (78-86)
		SUZUKI	CARRY (99-)
			SWIFT I (83-89)
			SWIFT II (89-05
		TALBOT	1307-1510 (75-8
			HORIZON (78-86)
			MURENA (80-85)
			RANCHO (77-84)
			SOLARA (80-86)
			TAGORA (80-87)
		TOFAS	DOGAN (76-02)
			KARTAL (91-)
			SAHIN (80-03)
		TVR	350 (83-89)
		VAUXHALL	ASTRA I (79-86)
			ASTRA II (84-94
			ASTRA III (F) (
			BRAVA (88-02)
			CARLTON II (77-
			CARLTON III (86
			CAVALIER I (75-
			CAVALIER II (81
			CAVALIER III (8
			CHEVETTE (75-85
			MIDI II (88-97)
			NOVA (82-94)
		VOLVO	240 (74-93)
			340-360 (75-91)
			440 (88-96)
			460 (88-96)
			740 (83-92)
			760 (81-92)
			940 I (90-95)
			940 II (94-98)
			960 I (90-94)
		VW	GOLF I (17, 155
			GOLF II (19, 1G
			LT 28-35 I (281
			PASSAT (32, 33)
			PASSAT (32B) (8
			POLO (86) (75-8
			SANTANA (81-85)
			SCIROCCO (53) (
		ZASTAVA	YUGO (80-95)
			YUGO Florida (8
		ZAZ	CHANCE (04-)
			LANOS (04-)

DENSO P/N	TT	MAKE	MODEL
W20EPR-U	W20TT		SENS (04-)
<i>continued</i>			SLAVUTA (95-)
			TAVRIJA (89-)
W20EPR-U11	W20TT	CHEVROLET	AVEO (T250, T25)
		HYUNDAI	H-1
			H100 (93-04)
			LANTRA I (90-95)
			PONY
			PONY (85-89)
			S COUPE (90-96)
			SANTA FÉ I (00-
			SANTAMO (99-)
			SONATA II (88-9
			SONATA III (93-
			SONATA IV (98-0
			TRAJECT (00-08)
		ISUZU	ASKA (95-01)
			CAMPO (77-91)
			PICK UP (87-96)
			TROOPER (83-91)
		KIA	MAGENTIS (01-)
		LADA	GRANTA (11-)
			NIVA II (2123)
		MAZDA	323 C IV (89-00
			323 S IV (89-94
			B-SERIE (99-)
		MITSUBISHI	COLT II (84-88)
			COLT III (88-92
			ECLIPSE I (89-9
			ECLIPSE II (94-
			GALANT III (84-
			GALANT IV (87-9
			L 200 (86-96)
			L 200 (96-07)
			L 300 (86-)
			LANCER III (83-
			LANCER IV (88-9
			SANTAMO (99-04)
			SIGMA (90-96)
			SPACE WAGON (83
			STARION (82-90)
		NISSAN	BLUEBIRD (80-86
			BLUEBIRD (83-90
			BLUEBIRD (85-92
			SILVIA (84-88)
		OPEL	CAMPO (87-)
		PROTON	PERSONA 400 (94
		ROVER	200 (XH) (85-89
		SAAB	90 (84-87)
			99 (68-84)
		SUBARU	JUSTY I (84-95)
			JUSTY II (95-03
			LEONE II (84-94
			LIBERO (83-00)
			REX II (81-89)
		SUZUKI	WAGON R+ (00-)
W20EP-U	W20TT	ALPINA	B9 (E24) (82-85
			B9 (E28) (81-85
			B10 (E34) (88-9
		AUDI	50 (86) (74-78)
			80 (80, 82, B1)
			80 (81, 85, B2)
			100 (43, C2) (7
			100 (44, C3) (8
			COUPE (81, 85)
		AUSTIN	1000-Series (70
			MAESTRO (83-92)
			METRO (80-90)
		AUSTIN-HEALEY	AUSTIN-HEALEY (
		BMW	02 (E6, E10) (6
			5 (E12) (72-81)

DENSO P/N	TT	MAKE	MODEL
W20EP-U	W20TT		1500-2000 (62-7
<i>continued</i>			2000 (E9) (65-7
		CITROËN	C25 (81-94)
		FIAT	DUCATO (82-90)
			PANDA (80-04)
			TALENTO (89-94)
			TIPO (87-95)
		FSO	125P (67-92)
			POLONEZ I (77-9
			POLONEZ II (88-
		LADA	1200-1600 (70-9
			NOVA (81-)
			SAMARA (86-)
		MAZDA	323 I (77-86)
		MERCEDES-BENZ	COUPE (C123) (7
			G-CLASS (W460)
			G-CLASS (W463)
			KOMBI (S123) (7
			Saloon (W123) (
			S-CLASS (W116)
			S-CLASS (W126)
			S-CLASS Coupe (
			SL (R107) (71-8
			SLC (C107) (72-
			T1 (601) (77-96
		MITSUBISHI	CORDIA (82-89)
			GALANT I (77-80
			L 200 (80-86)
			L 300 (80-87)
			SAPPORO I (78-8
			SAPPORO II (80-
		MORRIS	MARINA (71-80)
		MOSKOVICH	412 (71-)
			21412 (89-01)
		NISSAN	BLUEBIRD (80-86
			PICK UP (80-86)
		PEUGEOT	504 (68-89)
			505 (79-95)
			J5 (81-90)
			J5 (90-94)
			J7 (68-80)
			J9 (80-87)
		PUCH	G-MODELL (W460)
		RENAULT	5 (72-85)
			12 (69-80)
			18 (78-93)
			19 II (92-01)
			CLIO I (90-98)
			FUEGO (80-85)
			LAGUNA I (93-01
			MEGANE I (96-03
			MEGANE Scénic (
		ROVER	MAESTRO (90-95)
			MONTEGO (84-95)
		SAAB	900 I (78-94)
		SUBARU	LEONE I (78-84)
		TOYOTA	1000 (69-88)
		TRABANT	1.1 (90-91)
		VOLVO	240 (74-93)
			740 (83-92)
		VW	DERBY (86) (77-
			DERBY (86C, 80)
			GOLF I (17, 155
			GOLF II (19, 1G
			ILTIS (79-88)
			JETTA I (16) (7
			JETTA II (19, 1
			K 70 (70-74)
			LT 28-35 I (281
			LT 40-55 I (75-
			PASSAT (32, 33)

DENSO P/N	TT	MAKE	MODEL
W20EP-U	W20TT		PASSAT (32B) (8)
<i>continued</i>			POLO (86) (75-8)
			POLO (86C, 80)
			SCIROCCO (53) (
			SCIROCCO (53B)
		WARTBURG	353 (66-91)
		ZASTAVA	101 (73-93)
W20ESR-U	-	LAND ROVER	88
		MG	MGA (55-62)
		MORRIS	MINI (60-81)
			MINOR (55-71)
			OXFORD (59-70)
		PORSCHE	914 (69-76)
		SANTANA	LANDROVER 88
		VW	TRANSPORTER III
W20ES-U	-	VW	TRANSPORTER III
W20ETR-L	IW20TT	DAIHATSU	CHARADE III (87
		LOTUS	ESPRIT S4 (89-0
			EXCEL (83-91)
W20EXR-U	W20TT	ASTON MARTIN	LAGONDA (76-97)
		DAIHATSU	CHARADE II (83-
			CHARADE III (87
			CUORE I (80-85)
			CUORE II (85-90
			CUORE III (90-9
			CUORE V (96-98)
			EXTOL (00-)
		FORD	SIERRA (82-87)
			TAUNUS (75-79)
		HONDA	ACTY (79-86)
			INTEGRA (85-93)
			PRELUDE II (83-
		SUZUKI	SAMURAI (88-04)
		TOYOTA	CELICA (73-78)
			CELICA (77-85)
			CELICA Supra (8
			COROLLA (E7) (7
			CRESSIDA (80-93
			CROWN (80-85)
			STARLET (P7) (8
			STARLET (P8) (8
		WOLSELEY	HORNET (61-70)
W20EXR-U11	W20TT	HONDA	ACCORD II (83-8
			ACCORD III (85-
			CIVIC III (83-8
			CRX I (83-87)
		NISSAN	FIGARO (91-92)
		SUBARU	LEONE II (84-94
		TOYOTA	STARLET (P7) (8
W20EX-U	W20TT	AUSTIN	METRO (80-90)
		AUSTIN-HEALEY	AUSTIN-HEALEY (
		INNOCENTI	MINI (74-95)
		ISUZU	TROOPER (83-91)
		LAND ROVER	DEFENDER (90-)
			RANGE ROVER I (
		MG	METRO (82-90)
		TOYOTA	HILUX I (72-83)
W20FPR-U	WF20TT	CITROËN	2 CV (63-90)
			CX I (74-85)
			CX II (85-92)
			DYANE (67-84)
			HY (69-77)
		DACIA	1210 (83-94)
			1300 (72-83)
			1304 (83-04)
			1307 (84-94)
			1309 (90-01)
			1310 (83-04)
			1410 (85-98)
			PICK UP (89-00)
		DAF	66 (72-75)

DENSO P/N	TT	MAKE	MODEL
W20FPR-U	WF20TT	FIAT	PANDA (80-04)
<i>continued</i>		OPEL	ASCONA A (70-75
			ASCONA B (75-81
			CORSA A (82-93)
			FRONTERA A (92-
			GT (68-73)
			KADETT B (65-73
			KADETT D (79-84
			MANTA A (70-75)
			MANTA B (75-88)
			MONZA A (78-86)
			OLYMPIA A (67-7
			OMEGA A (86-94)
			REKORD B (65-67
			REKORD C (66-71
			REKORD D (72-77
			REKORD E (77-86
			SENATOR A (78-8
			SENATOR B (87-9
		RANGER	REKORD (72-78)
		SKODA	105
			RAPID (83-91)
		UAZ	3160 (94-)
			3162 (97-)
		VAUXHALL	ASTRA I (79-86)
			ASTRA II (84-94
			CARLTON III (86
			CAVALIER I (75-
			FRONTERA I (A)
			NOVA (82-94)
			SENATOR II (B)
		VOLVO	164 (68-74)
		WARTBURG	353 (66-91)
W20FP-U	WF20TT	CITROËN	C35 (73-94)
			CX I (74-85)
			CX II (85-92)
		FIAT	126 (72-00)
		OPEL	ASCONA B (75-81
			ASCONA C (81-88
			CORSA A (82-93)
			KADETT C (73-79
			OMEGA A (86-94)
			REKORD E (77-86
			SENATOR A (78-8
			SENATOR B (87-9
		RENAULT	12 (69-80)
			RODEO 4 (71-81)
		SKODA	105
			105
			RAPID (83-91)
		VOLVO	66 (75-79)
W20FSR-U	WF20TT	CITROËN	2 CV (63-90)
			ACADIANE (78-88
			AMI (63-77)
			DYANE (67-84)
			MEHARI (68-87)
		FIAT	500 (57-76)
		SKODA	110 (69-82)
		VW	1500, 1600 (61-
			KARMANN GHIA (5
			TRANSPORTER II
W20FS-U	WF20TT	CITROËN	LNA (76-86)
		SKODA	100 (70-77)
W20PR-U	-	MERCEDES-BENZ	COUPE (C123) (7
			G-CLASS (W460)
		OPEL	KADETT E (84-94
		PUCH	G-MODELL (W460)
W20TT	-	ALFA ROMEO	75 (85-92)
			155 (92-97)
			164 (87-98)
			1750-2000 (68-7

DENSO P/N	TT	MAKE	MODEL
W20TT	-		GIULIA (62-78)
<i>continued</i>			GT (63-77)
		ALPINA	B9 (E24) (82-85) B9 (E28) (81-85) B10 (E34) (88-9)
		ASTON MARTIN	DB6 (64-70) DBS (66-72) LAGONDA (76-97)
		AUDI	50 (86) (74-78) 80 (80, 82, B1) 80 (81, 85, B2) 80 (89, 8A, B3) 80 (8C, B4) (91) 90 (81, 85, B2) 90 (89, 8A, B3) 100 (43, C2) (7) 100 (44, C3) (8) 100 (4A, C4) (9) 100 (C1) (68-76) 200 (43) (79-82) 200 (44) (83-91) A6 (4A, C4) (94) CABRIOLET (8G7) COUPE (81, 85) COUPE (89, 8B) QUATTRO (85) (8)
		AUSTIN	1000-Series (70) ALLEGRO (73-84) MAESTRO (83-92) MAXI (69-82) METRO (80-90) MINI (60-93) MONTEGO (84-92) PRINCESS (76-82)
		AUSTIN-HEALEY	AUSTIN-HEALEY (
		AUTOBIANCHI	A 112 (69-85) Y10 (85-95)
		BEDFORD	MIDI (84-92)
		BENTLEY	CONTINENTAL (91) TURBO R (88-98)
		BMW	02 (E6, E10) (6) 3 (E21) (75-84) 3 (E30) (82-94) 5 (E12) (72-81) 5 (E34) (87-97) 1500-2000 (62-7) 2000 (E9) (65-7)
		CHEVROLET	AVEO (T250, T25) KALOS (05-) LANOS (05-) NIVA (2121) (02)
		CHRYSLER	VOYAGER (95-01) VOYAGER (00-08)
		CITROËN	C25 (81-94) GS (70-86)
		DACIA	NOVA (96-03)
		DAEWOO	CIELO (94-98) ESPERO (91-99) GENTRA (02-05) KALOS (02-) LACETTI (97-99) LANOS (97-) NEXIA (95-08) NEXIA (08-) TACUMA
		DAIHATSU	CHARADE II (83- CHARADE III (87 CUORE I (80-85) CUORE II (85-90) CUORE III (90-9 CUORE V (96-98)

DENSO P/N	TT	MAKE	MODEL
W20TT	-		EXTOL (00-)
<i>continued</i>		DODGE	CARAVAN (95-02)
		FIAT	126 (72-00) 127 (71-86) 128 (69-84) 131 (74-84) 132 (72-82) 900 T 900 T ARGENTA (78-86) CINQUECENTO (91 CROMA (85-96) DUCATO (82-90) DUNA (87-91) FIORINO (77-87) FIORINO (80-93) FIORINO (88-01) PANDA (80-04) REGATA (83-90) RITMO (78-88) RITMO Bertone () SEICENTO (98-10 TALENTO (89-94) TEMPRA (90-96) TIPO (87-95) UNO (83-00) X 1/9 (73-89)
		FORD	GRANADA (72-85) SIERRA (82-87) TAUNUS (75-79)
		FSO	125P (67-92) 126P (72-00) 127P (69-76) LANOS (04-08) POLONEZ I (77-9 POLONEZ II (88-
		HONDA	ACCORD II (83-8 ACCORD III (85- ACTY (79-86) CIVIC I (72-84) CIVIC II (79-83) CIVIC III (83-8 CRX I (83-87) INTEGRA (85-93) PRELUDE II (83-
		HYUNDAI	H-1 H100 (93-04) LANTRA I (90-95 PONY PONY (74-82) PONY (85-89) S COUPE (90-96) SANTA FÉ I (00- SANTAMO (99-) SONATA II (88-9 SONATA III (93- SONATA IV (98-0 STELLAR (83-91) TRAJECT (00-08)
		INNOCENTI	ELBA (91-96) MINI (74-95)
		ISUZU	ASKA (95-01) CAMPO (77-91) MIDI (88-) PICK UP (87-96) TROOPER (83-91)
		KIA	JOICE (00-) MAGENTIS (01-)
		LADA	110 (95-) 111 (95-) 112 (95-)

DENSO P/N	TT	MAKE	MODEL
W20TT	-		1200-1500 (73-8)
<i>continued</i>			1200-1600 (70-9)
			GRANTA (11-)
			KALINA (04-)
			NIVA (2121) (76)
			NIVA II (2123)
			NOVA (81-)
			SAMARA (86-)
			TOSCANA (83-12)
		LANCIA	BETA (73-86)
			BETA H.P.E. (76)
			BETA Monte Carl
			DEDRA (89-99)
			DELTA I (79-94)
			DELTA II (93-99)
			KAPPA (94-01)
			THEMA (84-94)
			TREVI (80-87)
			Y10 (85-95)
		LAND ROVER	DEFENDER (90-)
			DISCOVERY I (89
			RANGE ROVER I (
		LOTUS	ECLAT (75-86)
			ELITE (74-82)
			ESPRIT S2 (75-8
			ESPRIT S3 (80-8
			EXCEL (83-91)
		MAZDA	323 C IV (89-00
			323 I (77-86)
			323 III (85-95)
			323 S IV (89-94
			626 I (79-82)
			626 II (82-87)
			818 (74-78)
			929 I (79-86)
			929 II (82-87)
			1300 (75-77)
			B-SERIE (99-)
		MERCEDES-BENZ	COUPE (C123) (7
			G-CLASS (W460)
			G-CLASS (W463)
			KOMBI (S123) (7
			Saloon (W123) (
			S-CLASS (W116)
			S-CLASS (W126)
			S-CLASS Coupe (
			SL (R107) (71-8
			SLC (C107) (72-
			T1 (601) (77-96
		MG	1300 II (67-70)
			MAESTRO (83-90)
			METRO (82-90)
			MGB (66-80)
			MGC (67-69)
			MONTEGO (84-90)
		MITSUBISHI	COLT I (78-84)
			COLT II (84-88)
			COLT III (88-92)
			CORDIA (82-89)
			DEBONAIR (92-97
			ECLIPSE I (89-9
			ECLIPSE II (94-
			GALANT I (77-80
			GALANT II (80-8
			GALANT III (84-
			GALANT IV (87-9
			GALANT V (92-96
			L 200 (80-86)
			L 200 (86-96)
			L 200 (96-07)
			L 300 (80-87)

DENSO P/N	TT	MAKE	MODEL
W20TT	-		L 300 (86-)
<i>continued</i>			L 300 (94-00)
			L 400
			LANCER I (79-83
			LANCER III (83-
			LANCER IV (88-9
			MIRAGE (88-91)
			SANTAMO (99-04)
			SAPORO I (78-8
			SAPORO II (80-
			SIGMA (90-96)
			SPACE WAGON (83
			SPACE WAGON (91
			STARION (82-90)
		MORGAN	PLUS EIGHT (68-
		MORRIS	MARINA (71-80)
			MINI (60-81)
		MOSKVICHI	412 (71-)
			21412 (89-01)
		NISSAN	BLUEBIRD (80-86
			BLUEBIRD (83-90
			BLUEBIRD (85-92
			CEDRIC (83-87)
			CHERRY II (N10)
			CHERRY III (N12
			DATSUN 180 B (7
			FIGARO (91-92)
			LAUREL (77-83)
			LAUREL (81-85)
			PATHFINDER (86-
			PATROL (79-88)
			PICK UP (80-86)
			PRAIRIE (83-88)
			SILVIA (84-88)
			STANZA (81-85)
			SUNNY (70-82)
			SUNNY I (82-90)
			SUNNY II (86-91
			URVAN (81-98)
			VANETTE (81-87)
			VANETTE (86-95)
		OPEL	ASCONA B (75-81
			ASCONA C (81-88
			ASTRA F (91-01)
			CAMPO (87-)
			CORSA A (82-93)
			KADETT D (79-84
			KADETT E (84-94
			MANTA A (70-75)
			MANTA B (75-88)
			OMEGA A (86-94)
			REKORD E (77-86
			VECTRA A (88-95
		PEUGEOT	504 (68-89)
			505 (79-95)
			J5 (81-90)
			J5 (90-94)
			J7 (68-80)
			J9 (80-87)
		PIAGGIO	PORTER (93-)
		PININFARINA	SPIDEREUROPA (8
		PLYMOUTH	VOYAGER (95-01)
		PORSCHE	924 (75-89)
			944 (81-91)
			968 (91-95)
		PROTON	AEROBACK (88-96
			PERSONA 300 (96
			PERSONA 400 (94
			SAGA I (88-07)
			SALOON (91-96)
		PUCH	G-MODELL (W460)

DENSO P/N	TT	MAKE	MODEL
W20TT	-	RENAULT	4 (62-93)
<i>continued</i>			5 (72-85)
			6 (69-87)
			8 (62-72)
			9 (81-89)
			10 (66-72)
			11 (83-88)
			12 (69-80)
			16 (65-80)
			18 (78-93)
			19 I (88-92)
			19 II (92-01)
			20 (75-83)
			21 (86-95)
			CLIO I (90-98)
			ESTAFETTE (62-8
			FUEGO (80-85)
			LAGUNA I (93-01)
			MASTER I (80-98)
			MEGANE I (96-03
			MEGANE Scénic (
			RAPID (85-98)
			RODEO 6 (70-81)
			SUPER 5 (84-96)
			TRAFIC (80-89)
			TRAFIC (89-01)
		RILEY	ELF III (63-68)
		ROVER	200 (XH) (85-89
			MAESTRO (90-95)
			MINI (91-01)
			MONTEGO (84-95)
		SAAB	90 (84-87)
			99 (68-84)
			900 I (78-94)
		SANTANA	SAMURAI (86-95)
		SEAT	AROSA (6H) (97-
			CORDOBA (6K1) (
			CORDOBA (6K2) (
			FURA (82-86)
			IBIZA I (84-93)
			IBIZA II (6K1)
			IBIZA III (6K2)
			INCA (6K9) (95-
			MARBELLA (86-98
			PANDA (80-86)
			TERRA (87-96)
			TOLEDO I (1L) (
		SKODA	FELICIA Fun (97
			FELICIA I (6U)
			FELICIA II (6U)
			OCTAVIA (1U) (9
		SUBARU	JUSTY I (84-95)
			JUSTY II (95-03
			LEONE I (78-84)
			LEONE II (84-94
			LIBERO (83-00)
			MV (78-86)
			REX II (81-89)
		SUZUKI	CARRY (99-)
			SAMURAI (88-04)
			SWIFT I (83-89)
			SWIFT II (89-05
			WAGON R+ (00-)
		TALBOT	1307-1510 (75-8
			HORIZON (78-86)
			MURENA (80-85)
			RANCHO (77-84)
			SOLARA (80-86)
			TAGORA (80-87)
		TOFAS	DOGAN (76-02)
			KARTAL (91-)

DENSO P/N	TT	MAKE	MODEL
W20TT	-		SAHIN (80-03)
<i>continued</i>		TOYOTA	1000 (69-88)
			CELICA (73-78)
			CELICA (77-85)
			CELICA Supra (8
			COROLLA (E7) (7
			CRESSIDA (80-93
			CROWN (80-85)
			HIACE III (87-0
			HIACE IV (95-)
			HILUX I (72-83)
			LITEACE (92-97)
			MODELL F (82-90
			STARLET (P7) (8
			STARLET (P8) (8
		TRABANT	1.1 (90-91)
		TVR	350 (83-89)
		VAUXHALL	ASTRA I (79-86)
			ASTRA II (84-94
			ASTRA III (F) (
			BRAVA (88-02)
			CARLTON II (77-
			CARLTON III (86
			CAVALIER I (75-
			CAVALIER II (81
			CAVALIER III (8
			CHEVETTE (75-85
			MIDI II (88-97)
			NOVA (82-94)
		VOLVO	240 (74-93)
			340-360 (75-91)
			440 (88-96)
			460 (88-96)
			740 (83-92)
			760 (81-92)
			940 I (90-95)
			940 II (94-98)
			960 I (90-94)
		VW	CADDY I (14) (8
			CADDY II (9K, 9
			CORRADO (53I) (
			DERBY (86) (77-
			DERBY (86C, 80)
			GOLF I (17, 155
			GOLF II (19, 1G
			GOLF III (1H, 1
			GOLF IV (1J, 1E
			ILTIS (79-88)
			JETTA I (16) (7
			JETTA II (19, 1
			K 70 (70-74)
			LT 28-35 I (281
			LT 40-55 I (75-
			LUPO (6X, 6E) (
			PASSAT (3A2, 35
			PASSAT (32, 33)
			PASSAT (32B) (8
			POLO (6N1) (94-
			POLO (86) (75-8
			POLO (86C, 80)
			POLO Classic (6
			POLO Variant (6
			SANTANA (81-85)
			SCIROCCO (53) (
			SCIROCCO (53B)
			SHARAN (7M) (95
			TRANSPORTER III
			TRANSPORTER IV
			VENTO (1H2) (91
		WARTBURG	353 (66-91)
		WOLSELEY	HORNET (61-70)

DENSO P/N	TT	MAKE	MODEL
W20TT	-	ZASTAVA	101 (73-93)
<i>continued</i>			YUGO (80-95)
			YUGO Florida (8
		ZAZ	CHANCE (04-)
			LANOS (04-)
			SENS (04-)
			SLAVUTA (95-)
			TAVRIJA (89-)
W22EBR	-	MAZDA	RX 5 (75-81)
			RX 7 I (79-86)
W22EPB	W22TT	AUDI	COUPE (81, 85)
		FIAT	COUPE (93-00)
		LANCIA	DELTA I (79-94)
			DELTA II (93-99)
		SEAT	TOLEDO I (1L) (
		VW	POLO (86C, 80)
			TRANSPORTER III
W22EPR-U	W22TT	ALFA ROMEO	33 (83-93)
			33 (90-94)
			75 (85-92)
			90 (84-87)
			145
			155 (92-97)
			164 (87-98)
			166 (98-07)
			ALFASUD (72-89)
			ALFETTA (74-84)
			ALFETTA GT (74-
			AR 6 (79-89)
			ARNA (83-86)
			GIULIA (62-78)
			GIULIETTA (77-8
			GT (63-77)
			GTV (78-87)
			GTV (95-05)
			RZ (92-94)
			SPIDER (66-77)
			SPIDER (71-93)
			SPIDER (94-05)
			SZ (88-94)
		ASTON MARTIN	ZAGATO (86-89)
		AUDI	QUATTRO (85) (8
		AUTOBIANCHI	A 112 (69-85)
		BEDFORD	ASTRA VAN (82-9
			ASTRAMAX (85-90)
		FERRARI	400 i (79-85)
			DINO GT4 (74-80)
		FIAT	124 (66-85)
			125 (67-74)
			COUPE (93-00)
			CROMA (85-96)
			FIORINO (80-93)
			FIORINO (88-01)
			REGATA (83-90)
			RITMO (78-88)
			RITMO Bertone (
			TEMPRA (90-96)
			TIPO (87-95)
			UNO (83-00)
		FORD	GRANADA (72-85)
			SCORPIO I (85-9
			SIERRA (82-87)
			SIERRA (87-93)
		FSO	POLONEZ I (77-9
			POLONEZ II (88-
			POLONEZ III (92
		INNOCENTI	ELBA (91-96)
			KORAL (90-92)
		LANCIA	DEDRA (89-99)
			DELTA I (79-94)
			DELTA II (93-99)

DENSO P/N	TT	MAKE	MODEL
W22EPR-U	W22TT		GAMMA (81-84)
<i>continued</i>			PRISMA (83-92)
			THEMA (84-94)
		LOTUS	ECLAT (75-86)
			ELITE (74-82)
		MERCEDES-BENZ	SL (W121) (55-6
		MITSUBISHI	COLT II (84-88)
			ECLIPSE II (94-
			LANCER EVO (92-
		MOSKVICHI	407 (58-)
			2140 (78-83)
			21412 (89-01)
			ASLK 2137 (76-)
			ASLK 2140 (76-)
		PORSCHE	924 (75-89)
			944 (81-91)
		RENAULT	19 I (88-92)
			19 II (92-01)
			CLIO I (90-98)
		SEAT	131 (78-86)
			IBIZA III (6K2)
		SUBARU	1800 XT COUPE (
			LEONE II (84-94
		TOFAS	DOGAN (76-02)
			KARTAL (91-)
			SAHIN (80-03)
		TVR	280 (83-86)
			390 (84-89)
			420 (85-89)
		VOLVO	240 (74-93)
			440 (88-96)
			460 (88-96)
			480 (86-96)
		VW	DERBY (86C, 80)
			GOLF I (17, 155
			JETTA I (16) (7
			PASSAT (32B) (8
			POLO (86C, 80)
			SCIROCCO (53) (
			SCIROCCO (53B)
W22EP-U	W22TT	AUDI	80 (81, 85, B2)
			100 (43, C2) (7
		FIAT	126 (72-00)
		FORD	ESCORT II (73-8
		PEUGEOT	505 (79-95)
		RENAULT	9 (81-89)
			11 (83-88)
			19 II (92-01)
			21 (86-95)
			CLIO I (90-98)
			TRAFIC (80-89)
			TRAFIC (89-01)
		SAAB	900 I (78-94)
		SEAT	RONDA (82-88)
		VW	GOLF I (17, 155
			PASSAT (32B) (8
			POLO (86C, 80)
			SANTANA (81-85)
			TRANSPORTER III
W22ESR-U	-	ALFA ROMEO	GIULIETTA (77-8
		MG	MGA (55-62)
		MITSUBISHI	CORDIA (82-89)
			GALANT II (80-8
			GALANT III (84-
			STARION (82-90)
		NSU	TT (65-71)
			TTS (70-71)
		TVR	400 (89-93)
			450 (89-93)
			CHIMAERA (92-03
			GRIFFITH (90-02

DENSO P/N	TT	MAKE	MODEL
W22ESR-U	-		SPEED EIGHT (89)
<i>continued</i>			
W22ETR-L	-	MITSUBISHI	LANCER EVO (92-
W22FPR-U	-	ARO	240-244 (78-06)
		CITROËN	CX I (74-85) CX II (85-92)
		FIAT	126 (72-00)
		FSO	126P (72-00)
		PORSCHE	356 (50-68) 911 (901, 911) 912 (65-70)
		VOLVO	DUETT (61-67) P 121 (59-71) P 122 S Amazon P 544 (61-67) P 1800 (62-73) P 2200 (64-67)
W22FP-U	-	SKODA	130 (85-91)
		VOLVO	140 (66-75) 240 (74-93)
W22FS-U	-	PORSCHE	356 (50-68)
		TRABANT	P 601 (66-90)
		VOLVO	140 (66-75)
W22TT	-	ALFA ROMEO	33 (83-93) 33 (90-94) 75 (85-92) 90 (84-87) 145 155 (92-97) 164 (87-98) 166 (98-07) ALFASUD (72-89) ALFETTA (74-84) ALFETTA GT (74- AR 6 (79-89) ARNA (83-86) GIULIA (62-78) GIULIETTA (77-8 GT (63-77) GTV (78-87) GTV (95-05) RZ (92-94) SPIDER (66-77) SPIDER (71-93) SPIDER (94-05) SZ (88-94)
		ASTON MARTIN	ZAGATO (86-89)
		AUDI	80 (81, 85, B2) 100 (43, C2) (7 COUPE (81, 85) QUATTRO (85) (8
		AUTOBIANCHI	A 112 (69-85)
		BEDFORD	ASTRA VAN (82-9 ASTRAMAX (85-90
		FERRARI	400 i (79-85) DINO GT4 (74-80
		FIAT	124 (66-85) 125 (67-74) 126 (72-00) COUPE (93-00) CROMA (85-96) FIORINO (80-93) FIORINO (88-01) REGATA (83-90) RITMO (78-88) RITMO Bertone (TEMPRA (90-96) TIPO (87-95) UNO (83-00)
		FORD	ESCORT II (73-8 GRANADA (72-85)

DENSO P/N	TT	MAKE	MODEL
W22TT	-		SCORPIO I (85-9
<i>continued</i>			SIERRA (82-87) SIERRA (87-93)
		FSO	POLONEZ I (77-9 POLONEZ II (88- POLONEZ III (92
		INNOCENTI	ELBA (91-96) KORAL (90-92)
		LANCIA	DEDRA (89-99) DELTA I (79-94) DELTA II (93-99 GAMMA (81-84) PRISMA (83-92) THEMA (84-94)
		LOTUS	ECLAT (75-86) ELITE (74-82)
		MERCEDES-BENZ	SL (W121) (55-6
		MITSUBISHI	COLT II (84-88) ECLIPSE II (94- LANCER EVO (92-
		MOSKVICHI	407 (58-) 2140 (78-83) 21412 (89-01) ASLK 2137 (76-) ASLK 2140 (76-)
		PEUGEOT	505 (79-95)
		PORSCHE	924 (75-89) 944 (81-91)
		RENAULT	9 (81-89) 11 (83-88) 19 I (88-92) 19 II (92-01) 21 (86-95) CLIO I (90-98) TRAFIC (80-89) TRAFIC (89-01)
		SAAB	900 I (78-94)
		SEAT	131 (78-86) IBIZA III (6K2) RONDA (82-88) TOLEDO I (1L) (
		SUBARU	1800 XT COUPE (LEONE II (84-94
		TOFAS	DOGAN (76-02) KARTAL (91-) SAHIN (80-03)
		TVR	280 (83-86) 390 (84-89) 420 (85-89)
		VOLVO	240 (74-93) 440 (88-96) 460 (88-96) 480 (86-96)
		VW	DERBY (86C, 80) GOLF I (17, 155 JETTA I (16) (7 PASSAT (32B) (8 POLO (86C, 80) SANTANA (81-85) SCIROCCO (53) (SCIROCCO (53B) TRANSPORTER III
W24EPR-U	-	FORD	SIERRA (82-87)
		MASERATI	228 (86-90) 420 BITURBO (81-94)
		RENAULT	9 (81-89) 17 (72-80) 19 I (88-92) 21 (86-95) FUEGO (80-85)

DENSO P/N	TT	MAKE	MODEL
W24EPR-U	-		SUPER 5 (84-96)
<i>continued</i>			TRAFIC (80-89)
			TRAFIC (89-01)
W24ESR-U	-	AUTOBIANCHI	Y10 (85-95)
		CATERHAM	SUPER SEVEN (80)
		HONDA	N (68-74)
		PORSCHE	356 (50-68)
W27EBR	-	MAZDA	RX 7 I (79-86)
			RX 7 II (85-91)
			RX 7 III (92-02)
W27ES-V	-	RENAULT	12 (69-80)
W29EBR	-	MAZDA	RX 7 II (85-91)
WF20TT	-	CITROËN	2 CV (63-90)
			ACADIANE (78-88)
			AMI (63-77)
			C35 (73-94)
			CX I (74-85)
			CX II (85-92)
			DYANE (67-84)
			HY (69-77)
			LNA (76-86)
			MEHARI (68-87)
		DACIA	1210 (83-94)
			1300 (72-83)
			1304 (83-04)
			1307 (84-94)
			1309 (90-01)
			1310 (83-04)
			1410 (85-98)
			PICK UP (89-00)
		DAF	66 (72-75)
		FIAT	126 (72-00)
			500 (57-76)
			PANDA (80-04)
		OPEL	ASCONA A (70-75)
			ASCONA B (75-81)
			ASCONA C (81-88)
			CORSA A (82-93)
			FRONTERA A (92-
			GT (68-73)
			KADETT B (65-73)
			KADETT C (73-79)
			KADETT D (79-84)
			MANTA A (70-75)
			MANTA B (75-88)
			MONZA A (78-86)
			OLYMPIA A (67-7
			OMEGA A (86-94)
			REKORD B (65-67)
			REKORD C (66-71)
			REKORD D (72-77)
			REKORD E (77-86)
			SENATOR A (78-8
			SENATOR B (87-9
		RANGER	REKORD (72-78)
		RENAULT	12 (69-80)
			RODEO 4 (71-81)
		SKODA	100 (70-77)
			105
			105
			110 (69-82)
			RAPID (83-91)
		UAZ	3160 (94-)
			3162 (97-)
		VAUXHALL	ASTRA I (79-86)
			ASTRA II (84-94)
			CARLTON III (86
			CAVALIER I (75-
			FRONTERA I (A)
			NOVA (82-94)
			SENATOR II (B)

DENSO P/N	TT	MAKE	MODEL
WF20TT	-	VOLVO	66 (75-79)
<i>continued</i>			164 (68-74)
		VW	1500, 1600 (61-
			KARMANN GHIA (5
			TRANSPORTER II
		WARTBURG	353 (66-91)
X22ESR-U	-	BMW	3 (E30) (82-94)
X24EP-U9	-	BMW	3 (E30) (82-94)
X24ESR-U	-	LANCIA	THEMA (84-94)
		PORSCHE	959 (86-91)
XE20HR-U9	IXEH20TT	CITROËN	C2 (03-)
			C3 I (02-)
			C4 Coupe (04-)
			C4 I (LC) (04-)
		DACIA	LOGAN I (04-)
			LOGAN II (12-)
			LOGAN MCV II (1
			SANDERO I (08-)
			SANDERO II (12-
		NISSAN	KUBISTAR (03-)
		PEUGEOT	206 (98-)
			207 (06-)
			307 (00-)
			1007 (05-)
		RENAULT	CLIO II (98-)
			CLIO III (05-)
			CLIO IV (12-)
			KANGOO (97-)
			LOGAN II (13-)
			MODUS (04-)
			THALIA I (98-)
			THALIA II (08-)
			TWINGO I (93-)
			TWINGO II (07-)
XU20EPR-U	-	BMW	5 (E34) (87-97)
XU20HR9	-	DAIHATSU	ESSE (05-)
			MIRA GINO (06-)
			TANTO (02-)
		TOYOTA	PIXIS (11-)
XU22EPR-U	XU22TT	ALFA ROMEO	MITO (08-)
		AUDI	A3 (8P) (03-13)
		BMW	3 (E36) (90-00)
			5 (E34) (87-97)
		CHEVROLET	AVEO (T250, T25
			COBALT (11-)
			SPARK (10-)
			SPIN (12-)
		CHRYSLER	YPSILON (846) (
		DAEWOO	GENTRA (13-)
		FAW	V5 (12-)
		FIAT	500 (C) (07-)
			500L (12-)
			BRAVO II (06-)
			DOBLO (01-)
			DOBLO (10-)
			GRANDE PUNTO (0
			IDEA (03-)
			LINEA (07-)
			PANDA (03-)
			PANDA (12-)
			PUNTO (99-)
			PUNTO (12-)
			PUNTO EVO (08-1
			SEICENTO (98-10
			STILO (01-08)
		FORD	KA (08-)
		LANCIA	MUSA (04-)
			YPSILON (843) (
			YPSILON (846) (
		MITSUBISHI	PAJERO Mini (94
			TOPPO (90-03)

DENSO P/N	TT	MAKE	MODEL
XU22EPR-U	XU22TT	OPEL	COMBO (12-)
<i>continued</i>		PORSCHE	911 (996) (97-0)
		SUZUKI	ALTO IV (02-08)
			WAGON R+ (98-00)
XU22HDR9	XUH22TT	HYUNDAI	ACCENT
			ELANTRA (05-11)
			ELANTRA (11-)
			i20 (08-)
			i30 (07-12)
			i30 (11-)
			ix20 (10-)
		KIA	CARENS III (06-)
			CEED (06-)
			CEED (12-)
			CERATO (09-)
			PRO CEED (08-)
			RIO III (11-)
			SOUL I (09-)
			VENGA (10-)
		SMART	FORTWO (451) (0)
XU22PR9	XU22TT	DAIHATSU	SIRION (05-)
XU22TT	-	ALFA ROMEO	MITO (08-)
		AUDI	A3 (8P) (03-13)
		BMW	3 (E36) (90-00)
			5 (E34) (87-97)
		CHEVROLET	AVEO (T250, T25)
			COBALT (11-)
			SPARK (10-)
			SPIN (12-)
		CHRYSLER	YPSILON (846) (
		DAEWOO	GENTRA (13-)
		DAIHATSU	SIRION (05-)
		FAW	V5 (12-)
		FIAT	500 (C) (07-)
			500L (12-)
			BRAVO II (06-)
			DOBLO (01-)
			DOBLO (10-)
			GRANDE PUNTO (0
			IDEA (03-)
			LINEA (07-)
			PANDA (03-)
			PANDA (12-)
			PUNTO (99-)
			PUNTO (12-)
			PUNTO EVO (08-1
			SEICENTO (98-10
			STILO (01-08)
		FORD	KA (08-)
		LANCIA	MUSA (04-)
			YPSILON (843) (
			YPSILON (846) (
		MITSUBISHI	PAJERO Mini (94
			TOPPO (90-03)
		OPEL	COMBO (12-)
		PORSCHE	911 (996) (97-0)
		SUZUKI	ALTO IV (02-08)
			WAGON R+ (98-00)
XU24EPR-U	-	CHEVROLET	CRUZE (09-)
		FIAT	BRAVA (95-02)
			BRAVO I (95-01)
			IDEA (03-)
			MAREA (96-07)
			PALIO (96-)
			PUNTO (93-00)
			PUNTO (99-)
			SIENA (96-)
			STILO (01-08)
		LANCIA	Y (95-03)
		MASERATI	BITURBO (81-94)
			SHAMAL (89-95)

DENSO P/N	TT	MAKE	MODEL
XU24EPR-U	-	TVR	CERBERA (96-03)
<i>continued</i>			
XU27EPR-U	-	LANCIA	THEMA (84-94)
		MASERATI	BITURBO (81-94)
			GHIBLI II (92-)
			QUATTROPORTE IV
XUH20TTi	XUH20TTi	HYUNDAI	i10 (07-)
			i10 (13-)
			i20 (08-)
		KIA	PICANTO (11-)
			RIO III (11-)
XUH22TT	-	HYUNDAI	ACCENT
			ELANTRA (05-11)
			ELANTRA (11-)
			i20 (08-)
			i30 (07-12)
			i30 (11-)
			ix20 (10-)
		KIA	CARENS III (06-)
			CEED (06-)
			CEED (12-)
			CERATO (09-)
			PRO CEED (08-)
			RIO III (11-)
			SOUL I (09-)
			VENGA (10-)
		SMART	FORTWO (451) (0
ZT20EPR11	T20TT	ASTON MARTIN	DB9 (04-)
			VANQUISH (01-07
		FORD	C-MAX I (07-)
			FOCUS C-MAX (03
			FOCUS II (04-)
			GALAXY (06-)
			MAVERICK (01-)
			MONDEO III (00-
			MONDEO IV (07-)
			S-MAX (06-)
		JAGUAR	S-TYPE (99-08)
			XF (08-)
			XJ (03-09)
			XJ (09-)
			XK 8 (96-05)
			X-TYPE (01-09)
		MAZDA	3 (00-09)
			5 (05-)
			6 (02-07)
			MPV II (99-06)
			MPV III (06-)
			TRIBUTE (00-08)
		MORGAN	ROADSTER (04-)
		SHELBY	SERIES 1 (98-)
		VOLVO	C30 (06-12)
			S40 II (04-)
			S80 II (06-)
			V50 (04-)
			V70 III (07-)
ZXU20PR11	-	MITSUBISHI	DELICA (07-)
		NISSAN	PIXO (09-)
		OPEL	AGILA (08-)
		SUZUKI	ALTO V (09-)
			SOLIO (11-)
			SPLASH (08-)
			SWIFT IV (10-)
		VAUXHALL	AGILA II (B) (0

DENSO Cross Reference Chart



Spark & Glow Plugs

Cross Reference Chart - OE

This chart should be used for guidance only. Design and material differences between manufacturers may vary the Heat Range. See recommendations section for specific engine applications. Where manufacturers' names and/or numbers are stated these are given for reference purpose only and do not indicate source of manufacture or any connection in the course of trade with the manufacturers named.

AC	DENSO	TT
28G	DG-012	-
30G	DG-001	-
41XL	W27ESR-U	-
44F	W16FSR	-
60G	DG-175	-
C42CXLS	W20EPR-U	W20TT
C42XLS	W20EPR-U	W20TT
CR43CTS	T20PR-U	ITF20TT
S41XL	W27ESR-U	-

ALFA ROMEO	DENSO	TT
116610535800	DG-202	-
116760535801	DG-202	-
4249164	W20EPR-U	W20TT
4345041	W20EPR-U	W20TT
4393814	DG-001	-
4474413	DG-001	-
46447610	DG-102	-
46449690	PK20TR11	K20TT
46451951	DG-127	-
46480307	K20TNR	K20TT
46484273	XU24EPR-U	-
46521529	PK20TR11	K20TT
46521530	IU22	-
46550991	K20PBR-S10	K20TT
46550992	U22ETR	-
46751764	DG-129	-
46754154	DG-122	-
46759688	W20EPR-U	W20TT
46779614	DG-171	-
46792355	DG-170	-
46792359	DG-170	-
46796050	DG-171	-
4714294	DG-001	-
4729585	DG-001	-
4738576	DG-001	-
4752281	DG-001	-
4754011	DG-001	-
4774412	DG-001	-
4774413	DG-001	-
4781356	DG-001	-
4832279	DG-111	-
4849466	DG-001	-
60512848	K20PBR	K20TT
60569086	P20PR11	W20TT
60569957	PK20PR-P8	IK20TT
60571785	K20PR-U	K20TT
60571786	Q22PR-U	-
60593139	K20PBR	K20TT
60599495	IU22	-
60734155	W22ESR-U	-
60816139	DG-127	-
71741208	PT16VR13	TV16TT

APRILIA	DENSO	TT
0297542	X24ESR-U	-
0297830	IW31	-
0297921	U24ESR-N	-
0297942	XU27EPR-U	-
0297945	RU01-31	-
0897055	W24ESR-U	-
2BEN000088	W24FPR	-
2BEN000181	N24EXRB	-
2BEN000276	N24EXRB	-
8122586	X22ESR-U	-
8206870	W22FSR	-
8206871	W24FSR	-
8550352	U22ESR-N	-
8600008	W27EMR-C	-
COE06060	RU01-34	-

ASTON MARTIN	DENSO	TT
723116	Q20PR-U	Q20TT
770920	IQ24	-
785723	VT20	IT20TT

AUDI	DENSO	TT
N01781123	W22EPR-U	W22TT
N01781239	W22EPR-U	W22TT

AUTOBIANCHI	DENSO	TT
4401550	W20EPR-U	W20TT
7565476	W24ESR-U	-

BMW	DENSO	TT
12120022902	VXU24	-
12120030548	K20TXR	K20TT
12120031708	IK22	-
12120032134	VK20	IK20TT
12120032135	VK20	IK20TT
12120032136	K20TXR	K20TT
12120032137	VKH20	IKH20TT
12120032138	VKH20	IKH20TT
12120034098	VXUH22	-
12120034677	VXUH22	-
12120035531	VXUH22	-
12120035915	VKH20	IKH20TT
12120037607	K20TXR	K20TT
12120141871	K20TXR	K20TT
12120148593	K20TXR	K20TT
12121262360	W16EPR-U	W16TT
12121265595	W20EPR-U	W20TT
12121267485	W20EPR-U	W20TT
12121276283	W16EPR-U	W16TT
12121279526	W16EPR-U	W16TT
12121288234	W16EPR-U	W16TT
12121312569	XU20EPR-U	-
12121338145	W20EP-U	W20TT
12-12-1-338-145	W20EPR-U	W20TT
12121341422	K22TNR-S	-
12121341492	K22TNR-S	-
12121342125	K22TNR-S	-
12121342422	K22TNR-S	-
12121344520	K20TXR	K20TT
12121705914	K20TXR	K20TT
12121710731	J16CR-U	W16TT
12121711296	W20EPR-U	W20TT
12121714751	J16CR-U	W16TT
12121715539	K20TXR	K20TT
12121721895	J16CR-U	W16TT
12122158165	VXUH22	-
12122158252	IK20	IK20TT
12122158253	VKH20	IKH20TT
12122163332	VXUH22	-
12122293697	IXUH22	-
12122343144	X24ESR-U	-
12122993697	VXUH22	-
12127521112	VKH20	IKH20TT
12127526799	VK20	IK20TT
12127556979	IK22	-
12127570106	VXUH22	-
12127653439	U24ESR-NB	-
12127653771	K22TNR-S	-
12127664404	X24ESR-U	-
12127671302	XU22EPR-U	XU22TT
12127677560	XU24EPR-U	-
12127681415	XU22EPR-U	XU22TT
12127690603	XU24EPR-U	-
12127699116	IXU27	-
12127710636	IU27A	-
12127728634	XU24EPR-U	-
12127728635	IXU27	-
12129056446	W16EPR-U	W16TT

BMW	DENSO	TT
12129056447	W16EPR-U	W16TT
12129059794	K20TXR	K20TT
12129061382	K20TXR	K20TT
12129061383	J16CR-U	W16TT
12129061444	IW16	IW16TT
12129061455	J16CR-U	W16TT
12129061867	XU20EPR-U	-
12129061868	X22ESR-U	-
12129061869	J16CR-U	W16TT
12129061870	K20TXR	K20TT
12129061871	W20EPR-U	W20TT
12129061882	X22EPR-U9	-
12129063428	K20TXR	K20TT
12129064617	K20TXR	K20TT
12129064619	K20TXR	K20TT
12129064656	K20TXR	K20TT
12129065004	XU22EPR-U	XU22TT
12129065062	K20TXR	K20TT
12129065366	K20TXR	K20TT
12129068016	KJ14CR-L11	-
12129069048	VXU22	-
12129070999	KJ14CR-L11	-
12129071003	K20TXR	K20TT
12231288245	DG-001	-
12232240255	DG-001	-
12232241387	DG-001	-
12232241389	DG-001	-
12232248059	DG-145	-
12237786869	DG-178	-
12237788957	DG-191	-
12237791101	DG-240	-
12237798001	DG-607	-
12237806041	DG-180	-
12239061353	DG-001	-
12239061354	DG-001	-
1338145	W20EP-U	W20TT
7699166	IXU27	-

BRIGGS & STRATTON	DENSO	TT
BS19LM	W9LM-US	-
BS19LMR	W9LMR-US	-

CADILLAC	DENSO	TT
24425327	K20PBR-S10	K20TT

CATERPILLAR	DENSO	TT
194-8518	G13-1	-
2A3643	L14-U	-
2N2839	GE3-1	-
2W9486	W20EPR-U	W20TT
3B6583	W16LS	-
8F6347	W20M-US	-
9B0444	W20S-U	-
9M4141	W16PR-U	-
9M4142	W16PR-U	-

CHERY	DENSO	TT
A11-3707110CA	K20PR-U	K20TT

CHEVROLET	DENSO	TT
12622561	ITV20	ITV20TT
94837756	W20EPR-U	W20TT
96110493	W20EPR-U	W20TT
96307562	PK20PR-L11	IK20TT
96307729	K20PBR-S10	K20TT
96353255	W16EXR-U11	W16TT
96376288	XU22EPR-U	XU22TT
96417176	K20PBR-S10	K20TT
96440144	DG-604	-
96464000	XU22EPR-U	XU22TT
96990231	XU22EPR-U	XU22TT

Spark & Glow Plugs

Cross Reference Chart - OE

CHEVROLET	DENSO	TT
EC229566	K20TXR	K20TT
EC229626	K20TXR	K20TT

CHRYSLER	DENSO	TT
05058011AD	DG-117	-
05066840AA	DG-176	-
05080046AA	DG-117	-
05080047AB	DG-117	-
05175756AA	DG-194	-
4318131	W16EPR-U11	W16TT
4606402AB	ITL16	ITL16TT
4606591AA	IK16L	IK16TT
4606591AB	IK16L	IK16TT
4606823AB	KJ16CR-U11	K16TT
4609040	QJ16HR-U9	-
4609076	KJ14CR-L11	-
4609079	K16R-U11	K16TT
4622162	DG-176	-
4671057	K20PR-U	K20TT
4686083	W16EXR-U13	W16TT
4727114	P16R13	W20TT
4796779	PK16PR-L11	IK16TT
4863826	DG-109	-
5066840AA	DG-176	-
5098168AA	SK20PR-L9	IK20TT
5149002AA	ITL16	ITL16TT
5149003AA	ITL16	ITL16TT
5175756AA	DG-194	-
5213693	W16EPR-U	W16TT
5235010	W16EXR-U13	W16TT
5269556	IK20	IK20TT
5269897	K20PR-U	K20TT
56006240	IK16	IK16TT
56027108	KJ20CR-L11	K20TT
56028179	KJ20CR-L11	K20TT
56028189	QJ16HR-U9	-
5602886AA	K16R-U11	K16TT
56041402AB	KJ16CR-L11	K16TT
68000913AA	DG-190	-
68096212AA	DG-190	-
MS851552	IW16	IW16TT
MS851555	W20EPR-U	W20TT
MS851571	IK20	IK20TT
MS851622	IK20	IK20TT
S2RE14MCC5	ITL16	ITL16TT
S3RE14PLP5	ITL16	ITL16TT
SP00RC9MCC	K20R-U	K20TT
SP00RN12YC	W16EPR-U	W16TT
SP149125AD	ITV20	ITV20TT
SPL2TR4A11	ITL16	ITL16TT
SPOORN12YC	ITL16	ITL16TT
SPORC12YC5	K16R-U11	K16TT
SPRC12PEC5	PKJ16CR-L13	IK16TT
SPRE10PMC5	ITL20	-
SPRE14MCC4	ITL16	ITL16TT
SPRE14MCC5	ITL16	ITL16TT
SPRE14PLP5	ITL16	ITL16TT
SPRE14PMC5	ITL16	ITL16TT
SZFR5LP13G	IK16L	IK16TT

CITROEN/PEUGEOT	DENSO	TT
1606263780	VFK16	IK16TT
1607577680	VFKH16	IKH16TT
1612736680	DG-603	-
5403277	W20FPR-U	WF20TT
5418536	W20FSR-U	WF20TT
5493205	DG-001	-
59525G	K20PR-U	K20TT
5960.12	DG-113	-
5960.34	DG-010	-
5960.35	DG-106	-

CITROEN/PEUGEOT	DENSO	TT
5960.40	DG-214	-
5960.64	DG-181	-
5960.65	DG-181	-
5960.66	DG-116	-
5960.67	DG-116	-
5960.68	DG-003	-
5960.69	DG-003	-
5960.72	DG-111	-
5960.76	DG-140	-
5960.77	DG-140	-
5960.78	DG-180	-
5960.79	DG-180	-
5960.88	DG-130	-
5960.89	DG-130	-
5960.99	DG-614	-
5960.A0	DG-614	-
5960.A4	DG-195	-
5960.E6	DG-603	-
5960.E9	DG-113	-
5960.F4	DG-181	-
5960.F5	DG-116	-
5960.F6	DG-003	-
5960.F8	DG-140	-
5960.F9	DG-180	-
5960.G2	DG-130	-
5960.G6	DG-614	-
5960.G7	DG-001	-
5960.H6	DG-161	-
5960.K0	DG-004	-
5960.K4	DG-195	-
5960.K5	DG-111	-
5960.K6	DG-603	-
5960.L4	DG-621	-
596004	Q20PR-U	Q20TT
596007	W20EPR-U	W20TT
596008	W20EX-U	W20TT
596015	K20PR-U	K20TT
596017	K20HR-U11	KH20TT
596018	K20TXR	K20TT
596053	K16HPR-U11	KH16TT
596054	K16HPR-U11	KH16TT
596055	XE20HR-U9	IXEH20TT
596056	XE20HR-U9	IXEH20TT
596057	K16HPR-U11	KH16TT
596058	K16HPR-U11	KH16TT
596059	K20HR-U11	KH20TT
596062	K20HR-U11	KH20TT
596073	K20HR-U11	KH20TT
596075	K20HR-U11	KH20TT
596082	VKH16	IKH16TT
596083	XE20HR-U9	IXEH20TT
596084	XE20HR-U9	IXEH20TT
596085	K20HR-U11	KH20TT
596087	K20HR-U11	KH20TT
596090	K20HR-U11	KH20TT
596091	K16HPR-U11	KH16TT
596092	VXUH22	-
596093	VXUH22	-
596096	K20PR-U	K20TT
596097	K16HR-U11	KH16TT
596098	K20HR-U11	KH20TT
5960A5	VXUH22	-
5960C1	K20PR-U	K20TT
5960C2	K16PSR-B8	IK16TT
5960C3	K16PSR-B8	IK16TT
5960C4	K16PSR-B8	IK16TT
5960C5	K16PSR-B8	IK16TT
5960E1	VXUH22	-
5960E2	VXUH22	-
5960E3	K16HPR-U11	KH16TT
5960E4	K20HR-U11	KH20TT

CITROEN/PEUGEOT	DENSO	TT
5960F0	K20PR-U	K20TT
5960F1	K20TXR	K20TT
5960F2	K16HPR-U11	KH16TT
5960F3	K16HPR-U11	KH16TT
5960F7	K16HPR-U11	KH16TT
5960G0	VKH16	IKH16TT
5960G1	XE20HR-U9	IXEH20TT
5960G3	K20HR-U11	KH20TT
5960G4	VXUH22	-
5960G5	K20PR-U	K20TT
5960G8	T20EPR-U	T20TT
5960H7	K20HR-U11	KH20TT
5960H9	VXUH22	-
5960J0	W20EPR-U	W20TT
5960J2	K20PR-U	K20TT
5960J3	K20PR-U	K20TT
5960J4	T20EPR-U	T20TT
5960J5	K20PR-U	K20TT
5960J6	K20PR-U	K20TT
5960J7	K20TNR-S	K20TT
5960J8	K20PBR	K20TT
5960J9	K20PR-U	K20TT
5960K1	K20PBR	K20TT
5960K3	K20HR-U11	KH20TT
5960K9	VXUH22	-
5960L0	VXUH22	-
5960L2	K16HR-U11	KH16TT
5960L5	VXUH22	-
5960L0	IXUH22	-
5961.39	DG-001	-
5961.40	DG-001	-
5961.53	DG-001	-
5961.57	DG-001	-
5961-20	W22EPR-U	W22TT
596199	T20EPR-U	T20TT
5962.08	DG-001	-
5962.1P	DG-161	-
5962.1Q	DG-161	-
5962.1R	DG-001	-
5962.1S	DG-123	-
5962.1T	DG-001	-
5962.1V	DG-001	-
5962.1W	DG-004	-
5962.1X	DG-012	-
5962.1Y	DG-006	-
5962.1Z	DG-012	-
5962.2Y	DG-003	-
5962.2Z	DG-003	-
5962.35	DG-001	-
5962.3C	DG-116	-
5962.3E	DG-116	-
5962.3H	DG-001	-
5962.3J	DG-001	-
5962.5A	DG-111	-
5962.65	W20EPR-U	W20TT
5962.74	DG-001	-
5962.7F	DG-116	-
5962.H8	K16PR-U	K16TT
5962.J1	K16PR-U	K16TT
5962.J2	DG-006	-
5962.J3	DG-004	-
5962.J4	DG-001	-
5962.J5	DG-001	-
5962.J6	DG-001	-
5962.J7	DG-012	-
5962.K5	DG-001	-
5962.R8	DG-001	-
5962.S8	DG-001	-
5962.T1	DG-006	-
5962.T2	DG-012	-
5962.T7	DG-004	-

CITROEN/PEUGEOT	DENSO	TT
5962.U8	DG-001	-
5962.W2	DG-003	-
5962.W3	DG-003	-
5962.W8	DG-001	-
596205	T20EPR-U	T20TT
596209	T20EPR-U	T20TT
59620G	Q20PR-U	Q20TT
59620J	Q16PR-U	Q16TT
59620P	Q20PR-U	Q20TT
59620V	K20PR-U	K20TT
59620W	K20PR-U	K20TT
596213	W20EPR-U	W20TT
596214	T20EPR-U	T20TT
596215	T20EPR-U	T20TT
596216	W20EPR-U	W20TT
59621K	K20PR-U	K20TT
59621N	K20TXR	K20TT
596221	W20EPB	W20TT
596222	IW20	IW20TT
59622A	W20EPR-U	W20TT
59622J	K20TXR	K20TT
59622K	K20TXR	K20TT
59622W	K20PR-U	K20TT
59623L	W20EPR-U	W20TT
59623N	W20FPR-U	WF20TT
59623P	W20FPR-U	WF20TT
59623R	W20EPR-U	W20TT
59623T	W22EPR-U	W22TT
59623W	W22EPR-U	W22TT
59623X	W22EPR-U	W22TT
59624A	K20TXR	K20TT
59624E	W20EPR-U	W20TT
59624W	K20PR-U	K20TT
59625C	K16HPR-U11	KH16TT
59625G	K20PR-U	K20TT
59625M	K20HR-U11	KH20TT
59625V	W20FSR-U	WF20TT
59625W	T20EPR-U	T20TT
59625Y	W20EPR-U	W20TT
596261	T20EPR-U	T20TT
59626G	Q20PR-U	Q20TT
59626K	K20PR-U	K20TT
59626L	K20PR-U	K20TT
59626V	K20PR-U	K20TT
59626X	W22EPR-U	W22TT
596271	K20PR-U	K20TT
596272	T20EPR-U	T20TT
59627Q	K20PR-U	K20TT
59627S	K20PR-U	K20TT
59627W	K20HR-U11	KH20TT
59627X	K20HR-U11	KH20TT
596281	T20EPR-U	T20TT
596287	T20EPR-U	T20TT
5962-88	W22EPR-U	W22TT
59628A	VKH16	IKH16TT
596298	W22EPR-U	W22TT
596299	W20EPR-U	W20TT
5962A2	Q20PR-U	Q20TT
5962A5	VXUH22	-
5962A7	T20EPR-U	T20TT
5962A8	W20EPR-U	W20TT
5962C0	T16EPR-U	T16TT
5962C2	T20EPR-U	T20TT
5962C5	K20PR-U	K20TT
5962C6	K20PR-U	K20TT
5962C8	K22PB	-
5962E2	K20PR-U	K20TT
5962E3	K20PR-U	K20TT
5962-E9	W20EPR-U	W20TT
5962F7	Q20R-U	Q20TT
5962F8	Q20R-U	Q20TT

Spark & Glow Plugs

Cross Reference Chart - OE

DAIHATSU	DENSO	TT
99906-910X9009	IWF22	-
99906-910X9010	IWF22	-
99906-910X9011	IWF22	-
99906-910X9012	IW24	-
99906-910X9013	IW27	-
99906-910X9014	IX24	-
99906-910X9015	IX27	-
99906-910X9016	IX24B	-
99906-910X9017	IX27B	-
99906-910X9018	IXU22	-
99906-910X9019	IK16L	IK16TT
99906-910X9020	KJ20SR11	IK20TT
99906-910X9021	IUH24	-
99906-910X9022	IUH27	-
99906-910X9023	IU24	-
99906-910X9024	IU27	-
99906-910X9026	IW16	IW16TT
99906-910X9027	IW20	IW20TT
99906-910X9028	IK16	IK16TT
99906-910X9030	IK22	-
99906-910X9032	VK16	IK16TT
99906-910X9033	VK16	IK16TT
99906-910X9034	SVK20RZ8	IK20TT
99906-910X9034	VK20Y	-
99906-910X9035	VK20	IK20TT
99934-03685-100	IW24	-
99934-07685-100	W16EXR-U11	W16TT
99934-08685-100	W20EXR-U11	W20TT
99934-09685-100	W20FPR-U	WF20TT
99934-10685-100	W9EP	-
99934-11685-000	W16EXR-U11	W16TT
99934-12685-100	W16FPR-U	-
99934-13685-100	W20EPR-U11	W20TT
99934-14685-100	W16EXR-U13	W16TT
99934-15685	W20EXR-U11	W20TT
99934-16685	W20ESR-U	-
NDIK16	IK16	IK16TT
NDIK16A	IK16	IK16TT
NDIK20	IK20	IK20TT
NDIK20A	IK20	IK20TT
NDIK22	IK22	-
NDIK22A	IK22	-
NDIK24A	IK24	-
NDIK27A	IK27	-
NDIQ16	IQ16	IQ16TT
NDIQ16A	IQ16	IQ16TT
NDIQ20	IQ20	IQ20TT
NDIQ20A	IQ20	IQ20TT
NDIQ22	IQ22	-
NDIQ22A	IQ22	-
NDIQ24A	IQ24	-
NDIQ27A	IQ27	-
NDIW16	IW16	IW16TT
NDIW16A	IW16	IW16TT
NDIW20	IW20	IW20TT
NDIW20A	IW20	IW20TT
NDIW22	IW22	-
NDIW22A	IW22	-
NDIXU22	IXU22	-
NDIXU22A	IXU22	-
NDIXU24	IXU24	-
NDIXU24A	IXU24	-
NDIXUH22IA	IXUH22I	-
NDVK16	VK16	IK16TT
NDVK16A	VK16	IK16TT
NDVK20	VK20	IK20TT
NDVK20A	VK20	IK20TT
NDVK20Y	VK20Y	-
NDVK20YA	VK20Y	-
NDVK22	VK22	-
NDVK22A	VK22	-

DAIHATSU	DENSO	TT
NDVQ16	VQ16	IQ16TT
NDVQ16A	VQ16	IQ16TT
NDVQ20	VQ20	IQ20TT
NDVQ20A	VQ20	IQ20TT
NDVQ22	VQ22	-
NDVQ22A	VQ22	-
NDVW16	VW16	IW16TT
NDVW16A	VW16	IW16TT
NDVW20	VW20	IW20TT
NDVW20A	VW20	IW20TT
NDVW22	VW22	-
NDVW22A	VW22	-
NDVXU22	VXU22	-
NDVXU22A	VXU22	-
NDVXU24	VXU24	-
NDVXU24A	VXU24	-
NDVXUH22IA	VXUH22I	-

DODGE	DENSO	TT
5149177AB	KJ16CR-L11	K16TT
SPO0ZFR5AP	IK16	IK16TT
SPT10PMC5	ITL20	-

DUCATI	DENSO	TT
670.4.006.1	XU22EPR-U	XU22TT
670.4.007.1A	XU24EPR-U	-
670.4.012.1A	IX27	-
670.4.016.1B	U27ESR-N	-
670.4.023.1A	IU27	-
670.9.012.1A	IXU27	-
670.9.030.1A	RU01-31	-

FERRARI	DENSO	TT
155743	IXU27	-
167098	IU24	-
168325	IU24	-
169483	IU22	-
174954	IXU27	-
192637	IU24	-
2192637	IU24	-
FERRB0005	IX24	-

FIAT	DENSO	TT
4401547	W22FPR-U	-
4401549	W20EPR-U	W20TT
4401551	W20EPR-U	W20TT
4401552	W20EPR-U	W20TT
46093110	IW20	IW20TT
46144731	XU24EPR-U	-
46229251	W20EPR-U	W20TT
46413386	K20TNR	K20TT
46417010	K20PR-U	K20TT
46451923	K16TNR-S9	K16TT
46454145	K16PR-U	K16TT
46461873	XU24EPR-U	-
46463801	K20TNR	K20TT
46471078	K20PBR-S10	K20TT
46472021	K20TNR	K20TT
46475164	IK20	IK20TT
46480309	K16TNR-S9	K16TT
46480362	K20PR-U	K20TT
46481378	W22EPR-U	W22TT
46531917	XU24EPR-U	-
46531918	K16PR-U	K16TT
46531919	XU24EPR-U	-
46531935	K16PR-U	K16TT
46548478	K20PR-U	K20TT
46551918	K16PR-U	K16TT
46551935	K16PR-U	K16TT
46750545	XU24EPR-U	-
46799927	K16PR-U	K16TT

FIAT	DENSO	TT
46821457	K20PR-U	K20TT
46823299	XU22EPR-U	XU22TT
500316493	DG-111	-
500351992	DG-195	-
5493206	DG-001	-
55182623	IK16	IK16TT
55187863	DG-170	-
55188857	XU22EPR-U	XU22TT
55190788	XU22EPR-U	XU22TT
55198201	XU22EPR-U	XU22TT
55200817	DG-196	-
55210051	DG-621	-
55210685	IXU27	-
55226083	XU22EPR-U	XU22TT
55232360	VXU22	-
55249868	IXU27	-
5894585	W22EPR-U	W22TT
5894586	K20PR-U	K20TT
5894587	W20EPR-U	W20TT
5894588	Q22PR-U	-
5896177	K20TNR	K20TT
5896824	K20TNR	K20TT
5950464	DG-001	-
5951861	DG-001	-
5951879	DG-001	-
5951881	DG-001	-
5951882	DG-001	-
5973752	DG-001	-
5973753	DG-001	-
5984035	W22EPR-U	W22TT
5984036	W20EPR-U	W20TT
60504563	IW20	IW20TT
60507123	DG-202	-
60512929	W22EPR-U	W22TT
60579903	PK20PR-P8	IK20TT
60596245	DG-001	-
60597490	Q22PR-U	-
60617002	DG-109	-
60800325	W22EPR-U	W22TT
60806024	W20EPB	W20TT
60810689	PK20PR-P8	IK20TT
60812292	DG-001	-
60814613	DG-127	-
7029585	DG-001	-
71711638	IK20	IK20TT
71711639	W20EPR-U	W20TT
71711640	W20EPR-U	W20TT
71711806	W20EPR-U	W20TT
71711807	K20PR-U	K20TT
71711808	K20PR-U	K20TT
71719015	DG-001	-
71719244	K16PR-U	K16TT
71734087	DG-127	-
71735458	DG-122	-
71735459	DG-102	-
71735461	DG-001	-
71735464	DG-129	-
71736277	K16PR-U	K16TT
71736278	W20EPR-U	W20TT
71736279	W20EPR-U	W20TT
71737139	XU22EPR-U	XU22TT
71739210	PT16VR13	TV16TT
71741910	VK20	IK20TT
71750223	VK20	IK20TT
71769195	VXU22	-
7546518	Q20PR-U	Q20TT
7546519	K20PR-U	K20TT
7544432	W20EPR-U	W20TT
7544434	IW22	-
7544436	W22EPR-U	W22TT
7544437	W20EPR-U	W20TT

FIAT	DENSO	TT
7554444	W20EPR-U	W20TT
7554445	IWF20	-
7565853	IK20	IK20TT
7571541	K20PR-U	K20TT
7571564	IK22	-
7571575	W22EPR-U	W22TT
7571576	K20PR-U	K20TT
7571577	W20EPR-U	W20TT
7571579	IK22	-
762266740	DG-001	-
7632587	DG-132	-
7648199	DG-001	-
7651745	IW22	-
7668669	W20EPR-U	W20TT
7683358	IK20	IK20TT
7686643	W20EPB	W20TT
7698212	Q20PR-U	Q20TT
7702960	DG-001	-
7735920	DG-001	-
7754445	W22FPR-U	-
7760381	IW22	-
7760382	W20EPR-U	W20TT
7760383	IK20	IK20TT
7760384	Q22PR-U	-
7769243	K20TNR	K20TT
77719244	XU22EPR-U	XU22TT
7772453	K20PR-U	K20TT
7772456	W20EPR-U	W20TT
7772515	W22EPR-U	W22TT
7774321	Q22PR-U	-
7774341	W22EPR-U	W22TT
7777837	DG-004	-
7782067	K22PBR-S	-
7910247204	IT20	IT20TT
9151700180	W16EPR-U	W16TT
9405960078	W16EPR-U	W16TT
9616472480	DG-001	-
9618494580	K20TXR	K20TT
9618571880	K20TXR	K20TT
9619624580	K20TXR	K20TT
9623638380	DG-116	-
9628000280	K20PR-U	K20TT
9631658980	DG-003	-
9633214380	DG-001	-
9636393480	K20HR-U11	KH20TT
9636419280	K20PR-U	K20TT
9638985980	DG-116	-
9639814380	K20PR-U	K20TT
9649464080	K20HR-U11	KH20TT
9649464180	K20HR-U11	KH20TT
9650100080	DG-180	-
9651029780	DG-116	-
9651029880	DG-003	-
9651583680	DG-181	-
9657643780	VKH16	IKH16TT
9659279280	DG-130	-
98462490	DG-001	-
98498630	DG-004	-
F2VB	DG-001	-
FJ2A	DG-001	-
FJ4A	DG-001	-
KSP149125AD	ITV20	ITV20TT

FORD	DENSO	TT
1000996	PK20PR-L11	IK20TT
1001049	DG-007	-
1008792	DG-007	-
1011256	K20TXR	K20TT
1023706	VK20	IK20TT
1032705	K20TXR	K20TT
1037204	DG-005	-

Spark & Glow Plugs

Cross Reference Chart - OE

FORD	DENSO	TT
1056857	DG-007	-
1077002	PT16VR13	TV16TT
1079401	DG-121	-
1085952	T16EPR-U	T16TT
1086019	PK22PR-L11S	-
1087278	T20EPR-U	T20TT
1088847	ITV16	ITV16TT
1090749	PT16VR13	TV16TT
1096527	DG-130	-
1110500	K20PR-U	K20TT
1120170	PKJ16CR-L11	IK16TT
1120818	MA20P-U	-
1120820	MA20PR-U	-
11208212	IQ24	-
1120822	MA20PR-U	-
1120824	T20EPR-U	T20TT
1120825	T20EPR-U	T20TT
1120827	Q22PR-U	-
1120828	Q20PR-U11	Q20TT
1120829	K20PR-U	K20TT
1120830	K20PR-U	K20TT
1120831	Q20PR-U	Q20TT
1120833	IQ24	-
1120835	W24EPR-U	-
1120836	W20EXR-U	W20TT
1125332	VK20	IK20TT
1128053	ZT20EPR11	T20TT
1148105	DG-113	-
1151999	ITV24	-
1202935	PT16VR13	TV16TT
1204572	ZT20EPR11	T20TT
1207068	DG-109	-
1207069	DG-109	-
1216460	T20EPR-U	T20TT
1216466	T16VR-U10	TV16TT
1220057	PK20PR11	K20TT
1222858	VT20	IT20TT
1229477	VT20	IT20TT
1233897	T16VR-U10	TV16TT
1253749	VK20T	IK20TT
1307093	ZT20EPR11	T20TT
1309471	DG-130	-
1313809	DG-181	-
1315691	ZT20EPR11	T20TT
1324211	ZT20EPR11	T20TT
1369590	DG-180	-
1369704	ZT20EPR11	T20TT
1379739	ITV16	ITV16TT
1427905	DG-614	-
1430393	IKH20	IKH20TT
1439595	T16VR-U10	TV16TT
1441267	DG-311	-
1447128	DG-180	-
1473356	DG-181	-
1493001	T16VR-U10	TV16TT
1505812	IKH22	-
1518878	W20EPR-U	W20TT
1525910	DG-113	-
1542499	XU22EPR-U	XU22TT
1542845	DG-171	-
1583231	IKH20	IKH20TT
1587444	DG-001	-
1669977	DG-005	-
1680032	ITV22	-
1682276	DG-603	-
1686133	ITV20	ITV20TT
1690048	DG-109	-
1698597	ITV22	-
1703269	DG-603	-
1724842	DG-621	-
1952464	DG-137	-

FORD	DENSO	TT
1M5012405CA	PT16VR13	TV16TT
1R2312405AA	VW16	IW16TT
1S7G12405DA	ZT20EPR11	T20TT
1S7J12405DA	ZT20EPR11	T20TT
1S7J12405EB	ZT20EPR11	T20TT
2000077	PK20PR-P8	IK20TT
2C1G12405AA	VK20T	IK20TT
2M5V12405CA	ITV24	-
2S6Q6M090AA	DG-113	-
2S6Q6M090BB	DG-180	-
2U7J12405AA	T16VR-U10	TV16TT
3333704	PT16EPR-L13	IT16TT
3539125	PT16EPR-L13	IT16TT
3588254	KJ16CR-L11	K16TT
3899252	K20PR-U11	K20TT
3936373	PT16EPR-L13	IT16TT
3966269	T16VR-U10	TV16TT
3R2312405AA	IK16	IK16TT
3R2312405BA	IK20	IK20TT
3R2312405CA	IK20	IK20TT
3S4J12405AB	ZT20EPR11	T20TT
4025139	DG-146	-
4331810	PT16EPR-L13	IT16TT
4333361	IT20	IT20TT
4434918	DG-311	-
4454955	ZT20EPR11	T20TT
4496578	ITV22	-
4612191	DG-130	-
4716193	IT20	IT20TT
4M5G12405XD	T16VR-U10	TV16TT
5007956	DG-311	-
5023372	DG-001	-
5029052	W20EPB	W20TT
5029053	IW16	IW16TT
5031006	DG-001	-
5099342	T20EPR-U	T20TT
5099721	T20EPR-U	T20TT
5099722	IQ24	-
5099723	T20EPR-U	T20TT
5099725	IK22	-
5099726	IQ24	-
5099727	K20PR-U	K20TT
5099728	Q20PR-U11	Q20TT
5099729	IK20	IK20TT
5099731	MA20PR-U	-
5099732	MA20P-U	-
5099735	MA20P-U	-
5099739	T20EPR-U	T20TT
5099741	T20EPR-U	T20TT
5099742	W20EPR-U	W20TT
5099747	W20FPR-U	WF20TT
5099748	W20FSR-U	WF20TT
5099750	T22EP-U	-
5099751	W16EPR-U	W16TT
5099752	W24EPR-U	-
5099762	MA20P-U	-
5099763	MA20P-U	-
5099766	T20EPR-U	T20TT
5099767	W20EPR-U	W20TT
5099768	W20EPR-U	W20TT
5099769	W24EPR-U	-
5099770	Q22PR-U	-
5099775	Q20PR-U	Q20TT
5099777	K20PR-U	K20TT
5099778	Q22PR-U	-
5099779	Q20PR-U	Q20TT
5099780	IK22	-
5099781	T20EPR-U	T20TT
5099782	W20EPR-U	W20TT
5099783	W22EPR-U	W22TT
5099784	W20FPR-U	WF20TT

FORD	DENSO	TT
5099827	IK22	-
5099828	Q20PR-U	Q20TT
5099831	Q22PR-U	-
5099833	K20PR-U	K20TT
5099933	W20FSR-U	WF20TT
5099946	IT22	-
5099947	T22EP-U	-
5099949	W22EPR-U	W22TT
5099950	W24EPR-U	-
5100429	ITV22	-
5M5G12405AA	ZT20EPR11	T20TT
6075812	DG-012	-
6110609	DG-001	-
6132244	DG-123	-
6132246	DG-123	-
6154593	DG-001	-
6163811	DG-004	-
6173150	T20EPR-U	T20TT
6190831	K20PR-U11	K20TT
6726180	PT16VR10	TV16TT
6762458	PK22PR11	-
6G9Q6M090AA	DG-614	-
6M5G12405AA	IKH22	-
6M5J12405AA	IKH22	-
6M8G12405BB	ITV16	ITV16TT
7072673	DG-001	-
7088988	DG-004	-
7099023	PK20PR11	K20TT
7335128	IK20	IK20TT
795F6M090AA	DG-012	-
795F6M090CA	DG-012	-
83BB6M090A1A	DG-001	-
83BB6M090A2A	DG-001	-
84BB6M090AA	DG-001	-
84FF6M090B1A	DG-123	-
84FF6M090B2A	DG-123	-
840F12405JE	MA20PR-U	-
87YF12405AC	T20EPR-U	T20TT
87YF12405AD	T20EPR-U	T20TT
87YF12405AE	T20EPR-U	T20TT
89BF12405AC	T20EPR-U	T20TT
89FF6M090AA	DG-004	-
90592384	IK24	-
90594094	IK24	-
910X6M090AA	DG-006	-
910X6M090BA	DG-001	-
920F12405BLA	T20EPR-U	T20TT
920F12405CBA	Q20PR-U	Q20TT
928F12405AF	PT16VR13	TV16TT
920F12405CBB	Q20PR-U	Q20TT
920F12405EB	K20PR-U	K20TT
920F12405FB	Q20PR-U	Q20TT
920F12405TB	W20EXR-U	W20TT
93FF6M090AA	DG-004	-
930F12405JE	MA20P-U	-
959F12405AA	PK20PR-L11	IK20TT
95WF12405AB	VK20	IK20TT
95WF12405BB	PK22PR-L11S	-
96FF6M090AA	DG-007	-
96FF6M090AB	DG-007	-
96FF6M090BA	DG-007	-
96FF6M090BB	DG-007	-
978F12405AA	T20EPR-U	T20TT
97BF-12405-AA	T16EPR-U	T16TT
99FF6M090AA	DG-007	-
9A6G12405BA	ITV22	-
9S516M090AA	DG-171	-
AG9G12405BC	ITV20	ITV20TT
AV206M090BA	DG-603	-
AV6Q6M090BA	DG-603	-
BS516M090AA	DG-621	-

FORD	DENSO	TT
F43E12405EA	PT16EPR-L13	IT16TT
F43E12405EB	PT16EPR-L13	IT16TT
F75E12405CA	PT16EPR-L13	IT16TT
F7PE12405AA	T16VR-U10	TV16TT
H82SM12405AA	IK24	-
H82SM12405BA	IK24	-
V92HF12405BA	PK20PR-P8	IK20TT
V94DX6M090AA	DG-001	-
XM3412A342BA	DG-146	-
XS4F12405DA	PT16VR13	TV16TT
XS4U6M090AB	DG-121	-
XS6F12405BA	ITV16	ITV16TT
XS7U-6M090-BB	DG-130	-
YM2112405AA	PKJ16CR-L11	IK16TT

FSO	DENSO	TT
055124	DG-001	-
4238208	W20EP-U	W20TT
4559422	W22FPR-U	-

GM	DENSO	TT
12561454	IT16	IT16TT
12561466	PT16EPR-L13	IT16TT
12563554	DG-175	-
12563703	PTJ16R15	IT16TT
12563707	PTJ16R15	IT16TT
12563753	IT16	IT16TT
12565753	IT16	IT16TT
12565996	IKH20	IKH20TT
12568387	VT16	IT16TT
12571164	IT16	IT16TT
12571165	VT20	IT20TT
12571533	PT16EPR-L13	IT16TT
12571535	PT16EPR-L13	IT16TT
12578277	IT16	IT16TT
12597464	PT16VR13	TV16TT
12598004	ITL16	ITL16TT
12607234	PT16EPR-L13	IT16TT
12620540	ITV16	ITV16TT
12621258	IT16	IT16TT
12625058	ITL16	ITL16TT
12640384	DG-610	-
12788884	IKH20	IKH20TT
24504873	PT16EPR-L13	IT16TT
25108074	Q20PR-U	Q20TT
25109002	W20EPR-U	W20TT
25161442	PT16EPR-L13	IT16TT
25161444	PT16EPR-L13	IT16TT
25161677	PT16EPR-L13	IT16TT
25161678	PT16EPR-L13	IT16TT
25162555	PT16EPR-L13	IT16TT
25163148	PT16EPR-L13	IT16TT
25164048	PT16EPR-L13	IT16TT
25165715	PT16EPR-L13	IT16TT
25166821	PT16EPR-L13	IT16TT
25168651	DG-175	-
25173406	PT16EPR-L13	IT16TT
25186682	KJ20CR-L11	K20TT
25312442	PT16EPR-L13	IT16TT
25315018	PT16EPR-L13	IT16TT
25324618	PT16VR13	TV16TT
25338227	IT16	IT16TT
3490229	W20FPR-U	WF20TT
3490258	W20FPR-U	WF20TT
3490275	K20TXR	K20TT
3496307	W20EPR-U	W20TT
415129484	PK22PR8	-
5505819	W20FPR-U	WF20TT
55562534	KJ16CR-L11	K16TT
55565219	KJ20CR-L11	K20TT
5613100	W20EPR-U	W20TT

Spark & Glow Plugs

Cross Reference Chart - OE

GM	DENSO	TT
5614288	T20PR-U	ITF20TT
5614289	PT16EPR-L13	IT16TT
88900721	DG-145	-
90239569	W20FPR-U	WF20TT
90297143	W20FPR-U	WF20TT
90338179	K20PBR	K20TT
90350018	W20EPR-U	W20TT
90357582	K20PR-U	K20TT
90369815	K20TXR	K20TT
90397451	K20R-U	K20TT
90414815	W24FSR	-
90423215	K20PR-U	K20TT
90442210	K20PR-U	K20TT
90442650	K20TNR	K20TT
90444723	K20TXR	K20TT
90485247	W20EPR-U	W20TT
90487588	Q20PR-U	Q20TT
90509739	K20TXR	K20TT
90510924	DG-001	-
90512986	K20TXR	K20TT
90512989	W16EPR-U	W16TT
90541059	K20TXR	K20TT
9110724	DG-005	-
9110945	DG-008	-
91132006	K20TXR	K20TT
91132086	VK16	IK16TT
91132099	PT16VR13	TV16TT
91143774	W20EPR-U	W20TT
91149455	K20PR-U11	K20TT
91149686	K20TXR	K20TT
91153992	K20TXR	K20TT
91158431	PT16VR13	TV16TT
9146367	K20TXR	K20TT
9195109	K20TXR	K20TT
9195868	VK16	IK16TT
9196669	DG-142	-
9199038	PT16VR13	TV16TT
9201698	DG-126	-
92063308	K16PR-U11	K16TT
92067204	PT16VR13	TV16TT
92108895	PTJ16R15	IT16TT
92141875	T20EPR-U15	T20TT
92143446	T20EPR-U	T20TT
9270293	PK20PR-P8	IK20TT
93160201	PK20PR-P8	IK20TT
93161199	PK20PR-P8	IK20TT
93161342	DG-126	-
93161489	DG-126	-
93171875	DG-145	-
93171875	W20FSR-U	WF20TT
93175880	K20PBR	K20TT
93175935	K20PBR	K20TT
93175994	PK20PR-P8	IK20TT
93176467	PK20PR-L11	IK20TT
93176801	KJ16CR-L11	K16TT
93176802	KJ16CR-L11	K16TT
93178047	DG-171	-
93178225	DG-142	-
93178411	DG-170	-
93180295	DG-122	-
93180485	KJ16CR-L11	K16TT
93183738	DG-104	-
93183739	DG-300	-
93188550	K20TXR	K20TT
93189648	DG-005	-
93190433	DG-196	-
93190953	PK20PR-L11	IK20TT
93193723	ZXU20PR11	-
93196922	DG-005	-
93742296	W16EPR-U	W16TT
94217232	W20EPR-U11	W20TT

GM	DENSO	TT
94319700	DG-124	-
94402303	DG-159	-
94481972	DG-104	-
94856823	IK20	IK20TT
95508486	DG-171	-
96068562	K20PR-U	K20TT
96068563	K20PR-U	K20TT
96130723	K20PR-U11	K20TT
97044037	DG-104	-
97080554	DG-300	-
97125969	PK16PR-L11	IK16TT
97143674	DG-186	-
97357290	DG-312	-

HARLEY-DAVIDSON	DENSO	TT
10R12A	XU24EPR-U	-
10R12X	XU24EPR-U	-
2767101K	XU24EPR-U	-
3	W16LS	-
3230160	W16PR-U	-
3230180	IWF20	-
3231077	W16EXR-U	W16TT
3231183	W16EXR-U11	W16TT
3231278A	J16BR-U	-
3231786	XU22EPR-U	XU22TT
3231786A	XU22EPR-U	XU22TT
3232191	IXU22	-
3232691	W16EXR-U	W16TT
3232791	IW16	IW16TT
3262978	W16LS	-
34	W16PR-U	-
4	W16LS	-
45	W22FPR-U	-
4R	W16LS	-
4R5	W22FP-U10	-
4R5G	IWF22	-
5	W20S-U	-
5A6	W16EXR-U	W16TT
5A6A	W14EXR-U11	IW16TT
5R6	W16EXR-U	W16TT
5R6A	W16EXR-U11	W16TT
5R6AG	IW16	IW16TT
5R6APP	P16R	W20TT
5RL	J16CR-U	W16TT
6	W22ESR-U	-
6R12	XU22EPR-U	XU22TT
6R12G	IXU22	-
6R12PP	IXU22	-
6R7	W22EPR-U	W22TT
7	W24ESR-U	-
8	IW31	-
EVS13P	IW16	IW16TT
EVS13S	IW16	IW16TT
EX12P	IXU22	-
EX12S	XU22EPR-U	XU22TT

HINO	DENSO	TT
19110-1040	DG-236	-
19110-1180	DG-241	-
1985A-68030	DG-234	-
1985A-68040	DG-235	-
28550-1100	DG-236	-
6 301 3300 10	DG-236	-
6 301 3300 11	DG-236	-
S1911-01040	DG-236	-

HITACHI	DENSO	TT
42W	W27S-U	-
43W	W24S-U	-
44W	W22S-U	-
45PW	W20PR-U	-

HITACHI	DENSO	TT
45W	W20S-U	-
46PW	W16PR-U	-
46W	W16S-U	-
47PW	W14PR-U	-
47W	W14-US	-
48W	W9-U	-
83W	M24S	-
84VPW	MA20P-U	-
84W	M22	-
85W	M17	-
86VPW	MA16PR-U	-
86VW	MA16PR-U	-
C45VW	T22M-U	-
C45W	W22M-U	-
C46VW	T20M-U	-
C46W	W20M-US	-
L12W	U24FSR-U	-
L13W	U22FSR-U	-
L14W	U20FSR-U	-
L23W	X24ESR-U	-
L24W	X22ESR-U	-
L41W	W31ESR-U	-
L42W	W27ESR-U	-
L43PW	W24EPR-U	-
L43W	W24ESR-U	-
L44PW	W22EPR-U	W22TT
L44VPW	T20EPR-U	T20TT
L44W	W22ESR-U	-
L45PW	W20EP-U	W20TT
L45PW11	W20EPR-U11	W20TT
L45VPW	T16EPR-U	T16TT
L45W	W20ESR-U	-
L46PW	W16EPR-U	W16TT
L46PW11	W16EPR-U11	W16TT
L46W	W16ESR-U	-
L47PW	W14EPR-U	IW16TT
L47W	W14E	-
M23W	X24FS-U	-
M25W	X20FSR-U	-
M42W	W27FSR	-
M43PW	W24FP-U	-
M43W	W24FSR	-
M44PW	W22FPR-U	-
M44W	W22FS-U	-
M45PW	W20FPR-U	WF20TT
M45VPW	T20PR-U	ITF20TT
M45W	W20FSR-U	WF20TT
M46PW	W16FPR-U	-
M46VPW	T16PR-U	ITF16TT
M46W	W16FSR	-
M47VPW	T14PR-U	ITF16TT
M47W	W14F-U	-

HONDA	DENSO	TT
12290-5A2-A01	DXE22HQR-D11S	-
12290-5A2-A02	DXE22HQR-D11S	-
12290-PCX-000	PK22PR-L11S	-
12290-PGE-A01	PKJ20CR-M11	IK20TT
12290-PGE-A02	PKJ20CR-L11	IK20TT
12290-PHM-003	VKH20	IKH20TT
12290-PNE-003	KJ20DR-M11	IK20TT
12290-PNE-004	KJ20DR-M11	IK20TT
12290-PNL-E01	KJ20DR-M11	IK20TT
12290-PRB-A01	SK22PR-M11S	-
12290-R1A-A01	DXU22HCR-D11S	-
12290-R1A-A010M2	DXU22HCR-D11S	-
12290-R1A-H01	SXU22HCR11S	-
12290-R40-A01	SXU22HCR11S	-
12290-R40-A02	SXU22HCR11S	-
12290-R41-L01	DXU22HCR-D11S	-
12290-R60-002	SKJ20DR-M11S	-

HONDA	DENSO	TT
12290-R60-U01	SKJ20DR-M11S	-
12290-R60-U02	SKJ20DR-M11S	-
12290-R71-L01	DXU22HCR-D11S	-
12290-RB0-J01	DK20PR-D13	-
12290-RB0-JB11	DK20PR-D13	-
12290-RB1-003	SKJ20DR-M13	IK20TT
12290-RB1-004	SKJ20DR-M13	IK20TT
12290-RBJ-003	VFKH20	IKH20TT
12290-RGB-A004	VK20G	-
12290-RL6-G01	VXUHC22G	-
12290-RMX-003	VKH20	IKH20TT
12290-RMX-004	VKH20	IKH20TT
12290-RMX-013	VKH20	IKH20TT
12290-RMX-014	VKH20	IKH20TT
12290-RSH-003	SK20PR-L11	IK20TT
12290-RSH-004	SK20PR-L11	IK20TT
12290-RTW-004	DK20PR-D13	-
12290-RW0-003	VFKH20	IKH20TT
12291-P5T-G00	DG-101	-
12291-P5T-G02	DG-101	-
12291-PHM-003	VKH20	IKH20TT
12291-PLZ-D00	DG-302	-
12291-RBD-E01	DG-601	-
12292-PHM-003	VKH20	IKH20TT
12293-PHM-003	VKH20	IKH20TT
31901-NF4-J6511	IW01-32	-
31911-KRN-731	IU01-24	-
31911-KSK-731	W27ESR-V	-
31911-MBT-F21	IX24B	-
31911-MBW-E11	VUH24D	-
31911-MCW-003	VNH24Z	-
31912-HW1-671	VNH27Z	-
31912-KRN-731	IU01-27	-
31912-MBW-E11	VUH27D	-
31912-MCW-003	VNH27Z	-
31912-MEL-003	VUH27ES	-
31912-MFL-003	VUH27ES	-
31916-KPH-901	U20EPR9	-
31916-KRM-841	U24EPR9	-
31916-KSP-8610M1	U20EPR9	-
31916-KWB-601	U20EPR9	-
31916-MEH-003	IU24	-
31916-MEH-0030	IU24	-
31916-ZY3-003	VKJ20RZ-M11	-
31916-ZY3-004	VKJ20RZ-M11	-
31918-MEB-671	VK24PRZ11	-
31918-MEB-672	VK24PRZ11	-
31919-MEB-671	VK27PRZ11	-
31919-MEB-672	VK27PRZ11	-
31921-MBW-E12	VUH24D	-
31921-MFF-D000	U24EPR9	-
31921-MOW-004	VNH24Z	-
31922-MBW-E12	VUH27D	-
31922-MCW-004	VNH27Z	-
31922-MEL-003	VUH27ES	-
31922-MOW-004	VNH27Z	-
31926-KPH-901	U20EPR9	-
31928-MFF-D01	U24EPR9	-
31940-NX5-7520-M1	IA01-32	-
31940-NX5-9410	IA01-32	-
31940-NX5-A0030	IAE01-32	-
31988-GEV-761	Y24FER-C	-
31989-GEV-761	Y27FER-C	-
98049-58716	Y24FER-C	-
98049-59716	Y27FER-C	-
98049-60716	Y31FER-C	-
98052-56471	U20M-U	-
98056-54750	U14FSR-UB	-
98056-54757	U14FSR-UB	-
98056-5475U	IUF14-UB	-
98056-55713	U16FSR-U	-

Spark & Glow Plugs

Cross Reference Chart - OE

HONDA	DENSO	TT
98079-5714H	PK22PR-L11S	-
98079-5714J	K22PR-L11	-
98079-5714P	KJ22CR-L11	-
98079-57155	W22EPR-U11	W22TT
98079-57158	Q22PR-U11	-
98079-5715E	K22PR-U11	-
98079-5715G	KJ22CR-L11	-
98079-5715H	PK22PR-L11S	-
98079-5715J	K22PR-L11	-
98079-5715U	VK22PRZ11	-
98079-5715V	SK22PR-M11	-
98079-57171	W22EPR-U11	W22TT
98079-57173	IW22	-
98079-57175	W20EKR-S11	IW20TT
98079-5717U	VK22PRZ11	-
98079-5717V	SK22PR-M11S	-
98079-57181	W22EPR-U11	W22TT
98079-57183	IW22	-
98079-57185	W22EPR-U11	W22TT
98079-571BH	PK22PR-L11S	-
98079-571BV	SK22PR-M11S	-
98079-571CH	PK22PR-L11S	-
98079-571CV	SK22PR-M11S	-
98079-57816	W22ESR-U	-
98079-57840	W22ESR-U	-
98079-57841	W22EPR-U	W22TT
98079-57846	W22EPR-U	W22TT
98079-57855	W22EPR-U	W22TT
98079-5785C	IK22	-
98079-5785G	KJ22CR-L8	-
98079-57877	W22ESR-U	-
98079-5787G	KJ22CR-L8	-
98079-5787T	PK22PR8	-
98079-5814E	K24PR-U11	-
98079-5815E	K24PR-U11	-
98079-5815U	IK24C11	-
98079-5817U	IK24C11	-
98079-58644	IW24	-
98079-58646	IW24	-
98079-58659	W24ESR-V	-
98079-58678	W24ES-V	-
98079-58679	W24ESR-V	-
98079-58816	W24ESR-U	-
98079-58819	W24ESR-U	-
98079-58840	W24ESR-U	-
98079-58842	W24ESR-U	-
98079-58846	W24ESR-U	-
98079-58847	W24EPR-U	-
98079-58857	W24ESR-U	-
98079-5915U	IK27C11	-
98079-5917U	IK27C11	-
98079-59644	IW27	-
98079-59659	W27ESR-V	-
98079-59678	W27ES-V	-
98079-59679	W27ESR-U	-
98079-59811	W27ESR-U	-
98079-59816	W27ESR-U	-
98079-59819	W27ESR-V	-
98079-59827	W27ESR-U	-
98079-59840	W27ESR-U	-
98079-59847	W27ESR-U	-
98079-59855	W27EMR-C	-
98079-59872	W27ES-V	-
98079-59875	W27EMR-C	-
98079-59876	W27ESR-U	-
98079-60000	W22EPR-U11	W22TT
98079-60679	IW31	-
98079-60817	W31ESR-U	-
98079-60875	IWM31	-
9807B-5515W	SKJ16DR-M11	IK16TT
9807B-5615P	KJ20DR-M11	IK20TT

HONDA	DENSO	TT
9807B-5615W	SKJ20DR-M11	IK20TT
9807B-5617C	VK20G	-
9807B-5617P	KJ20DR-M11	IK20TT
9807B-5617W	SKJ20DR-M11	IK20TT
9807B-561BP00	SKJ20DR-M11S	-
9807B-561BW	SKJ20DR-M11	IK20TT
9807B-561CP	SKJ20DR-M11S	-
9807B-561CW	SKJ20DR-M11S	-
9807B-56A5W	SKJ20DR-M13	IK20TT
9807B-56A7W	SKJ20DR-M13	IK20TT
H98515-517J	IK16	IK16TT
H98515-517K	IK16	IK16TT
H98515-617J	IK20	IK20TT
H98515-617K	IK20	IK20TT
H98515-617Q	IQ20	IQ20TT
H98535-617L	IK20	IK20TT
H98795-518K	VK16	IK16TT
H98795-518Q	VQ16	IQ16TT
H98795-618K	VK20	IK20TT
H98795-618Q	VQ20	IQ20TT
H98795-718K	VK22	-
H98805-518K	VK16	IK16TT
H98805-518Q	VQ16	IQ16TT
H98805-618K	VK20	IK20TT
H98805-618Q	VQ20	IQ20TT
H98805-718K	VK22	-
H98815-515K	VK16	IK16TT
H98815-615K	VK20	IK20TT
H98885-618K	VK20	IK20TT
ZH98000-1000	W20EPR-U	W20TT
ZH98000-2000	U27ESR-N	-
ZH98000-3000	X24ESR-U	-
ZH98000-4000	U24ESR-N	-
ZH98000-5000	X27ESR-U	-
ZJ98000-2000	U27ETR	-
ZJ98000-3000	X27ETR	-
ZJ98000-4000	U24ETR	-
ZK98000-1000	U22ESR-N	-

HUSQVARNA	DENSO	TT
800057446	W27ESR-V	-
800077478	U24ES-N	-
8A0057446	W27ESR-V	-
8B0057446	U22ESR-N	-

HYUNDAI	DENSO	TT
08914-18110	W16EXR-U	W16TT
099PM-18000	PK16PR11	K16TT
099PM-18010	P16PR11	W16TT
18811-08061	W20EPR-U11	W20TT
18811-11051	W16EXR-U11	W16TT
18811-11060	W20EPR-U11	W20TT
18811-11061	W20EPR-U11	W20TT
18812-11061	W20EPR-S11	W20TT
18813-11051	P16PR11	W16TT
18814-08051	K16PR-U11	K16TT
18814-08061	K20PR-U	K20TT
18814-08062	K20PR-U	K20TT
18814-11041	K16PR-U11	K16TT
18814-11051	K16PR-U11	K16TT
18814-11061	K20PR-U11	K20TT
18814-25000	SK16PR-A11	IK16TT
18817-11051	PK16PR-L11	IK16TT
18818-11051	P16PR11	W16TT
18822-08091	W20EPR-U11	W20TT
18822-11090	W20EPR-U11	W20TT
18822-11091	W20EPR-U11	W20TT
18823-08071	K22PR-U	-
18823-08091	K20PR-U	K20TT
18823-08101	K16PR-U11	K16TT
18823-11091	K20PR-U11	K20TT

HYUNDAI	DENSO	TT
18823-11101	K16PR-U11	K16TT
18823-11102	K16PR-U	K16TT
18825-11101	P16PR11	W16TT
18826-11101	PK16PR-L11	IK16TT
18827-09080	SXU22HDR8	-
18829-11050	KJ16CR-U11	K16TT
18835-11161	P16PR11	W16TT
18837-08051	K16PR-U11	K16TT
18840-11051	VKH16	IKH16TT
18841-11051	K16HPR-U11	KH16TT
18843-08062	XUH20TTi	XUH20TTi
18843-10062	XUH20TTi	XUH20TTi
18845-08200	VFKH20	IKH20TT
18845-11160	VFKH16	IKH16TT
18846-10060	VXUH20I	-
18846X10070	VXUH22I	-
18846-11070	VXUH22I	-
18847-08200	ZXU20HCR8	-
18847-11160	FXU16HR11	-
18850-11050	VFKH16	IKH16TT
18854-09080	XU22HDR9	XUH22TT
18854-10080	XU22HDR9	XUH22TT
18855-10060	XU22HDR9	XUH22TT
27400-18110	K20PR-U	K20TT
27410-23700	SK16PR-L11	IK16TT
27410-37100	PK16PR-L11	IK16TT
27410-3C000	SK16PR-L11	IK16TT
36710-27000	DG-173	-
36710-27010	DG-173	-
36710-29000	DG-001	-
36710-29001	DG-001	-
36710-2A100	DG-602	-
36710-2A200	DG-602	-
36710-42000	DG-172	-
36710-42010	DG-172	-
36710-42020	DG-172	-
36710-42021	DG-198	-
36710-42500	DG-174	-
36710-42510	DG-172	-
36710-42550	DG-198	-
36710-4A000	DG-189	-
36710-4A100	DG-189	-
Y18823-11101	K16PR-U11	K16TT

INNOCENTI	DENSO	TT
6553206604	W20EPR-U	W20TT
6563208605	W20EPR-U	W20TT
7510960	W20EPR-U	W20TT

ISUZU	DENSO	TT
5-81380001-0	W16EPR-U	W16TT
5-81380005-0	W16EPR-U	W16TT
5-81380006-0	W20EP-U	W20TT
5-81380007-0	W16EXR-U	W16TT
5-81380008-0	W20EX-U	W20TT
5-81380012-0	W16EXR-U11	W16TT
5-81380013-0	W20EXR-U11	W20TT
5-86003122-0	KJ16CR-U11	K16TT
5-86003124-0	KJ20CR-U11	K20TT
5-86007635-0	K16PR-U11	K16TT
5-86007636-0	KJ16CR-L11	K16TT
5-86007639-0	KJ20CR-L11	K20TT
5-86013957-0	PKJ16CR-L13	IK16TT
5-86103386-0	PK20PR11	K20TT
5-86103389-0	P16PR11	W16TT
5-86121749-0	K16PR-U11	K16TT
8-94120560-0	W16EXR-U11	W16TT
8-94120561-0	W16EXR-U11	W16TT
8-94120562-0	W20EXR-U11	W20TT
8-9413-3759-1	DG-108	-
8-9413-3759-6	DG-108	-

ISUZU	DENSO	TT
8-9414-0115-6	DG-108	-
8-94160627-0	W20EXR-U	W20TT
8-94217232-0	W20EPR-U11	W20TT
8-94219943-0	W20EPR-U	W20TT
8-9422-1719-3	DG-143	-
8-94235966-0	W16EPR-U11	W16TT
8-94237203-0	W16EXR-U11	W16TT
8-94241059-0	W20EPR-U11	W20TT
8-9424-1449-0	DG-143	-
8-9424-1449-1	DG-143	-
8-9424-1490	DG-143	-
8-9424-9692-1	DG-143	-
8-94252270-0	W20EXR-U11	W20TT
8-9425-5588-0	DG-143	-
8-9431-9700-1	DG-124	-
8-9431-9700-2	DG-124	-
8-94328372-0	K20PR-U11	K20TT
8-94328374-0	K20PR-U11	K20TT
8-94328375-0	K22PR-U11	-
8-9440-2303-1	DG-159	-
8-9443-9218-0	DG-143	-
8-9448-1972-0	DG-104	-
8-97012928-0	K20PR-U	K20TT
8-97012930-0	K20PR-U	K20TT
8-97012931-0	K22PR-U	-
8-97111376-0	PK16PR11	K16TT
8-9714-3674-1	DG-186	-
8-97170268-0	IK16	IK16TT
8-97210-818-2	DG-302	-
8-97380046-0	GX8-1	-
8-97389-905-0	DG-302	-
9-82513103-0	W20EPR-U	W20TT
9-82513106-0	W16EPR-U	W16TT
9-89119290-0	GX8-1	-

IVECO	DENSO	TT
27600323	DG-195	-
4783047	DG-001	-
4841294	DG-001	-
4849406	DG-001	-
504082651	IK22	-
88032415	IK22	-

JAGUAR	DENSO	TT
02JD61604	DG-140	-
2JD61604	DG-140	-
4U3Q6M090AA	DG-140	-
AJ812146	VFXEH20	IXEH20TT
AJ84575	SK16PR-A11	IK16TT
C2A1535	SK16PR-A11	IK16TT
C2S40053	DG-130	-
C2S46895	IT20	IT20TT
EAC008584	T22EP-U	-
EAC8917	W16EPR-U	W16TT
EBC004021	T22EP-U	-
EBC11480	K20PR-U	K20TT
EBC4021	T22EP-U	-
EBC8143	K16PR-U	K16TT
JAGUB0009	VK16	IK16TT
JD61164	DG-130	-
NAB3850DA	T20EPR-U	T20TT
NCA3850DA2	IK20	IK20TT
NCA3850FA1	IK16	IK16TT
NCA3850HA2	PK20PR-L13	IK20TT
XR811790	IT20	IT20TT
XR815349	IT20	IT20TT
XR815350	PK16PR-L11	IK16TT
XR819660	ZT20EPR11	T20TT
XR82810	IK20	IK20TT
XR842795	ZT20EPR11	T20TT

Spark & Glow Plugs

Cross Reference Chart - OE

JEEP	DENSO	TT
33002750	QJ16HR-U9	-
33003862	K20PR-U	K20TT
56026240	QJ16HR-U9	-
56027275	KJ16CR-L11	K16TT
56028236AA	KJ16CR-L11	K16TT
LCTR5A13A	ITL16	ITL16TT
S2RE14PLP5	ITL16	ITL16TT
SP000ZFR5N	KJ16CR-L11	K16TT
SPORC12ECC	KJ16CR-L11	K16TT
SPOZFR5F11	KJ16CR-U11	K16TT
SPLZFR5C11	K16HPR-U11	KH16TT
SPLZTR5A13	ITL20	-
SPRC12MCC4	KJ16CR-L11	K16TT
SPRC7PYCB4	IK20	IK20TT
SPRE14MCCS	ITL16	ITL16TT
SPZFR6F11G	KJ20CR-L11	K20TT

KAWASAKI	DENSO	TT
92070-1171	U24ESR-N	-
92070-1183	U22FSR-U	-
92070-1184	U24FSR-U	-
92070-1187	IW31	-
92070-1188	IW31	-
92070-1203	W22FPR-U	-
92070-1209	U22ESR-N	-
92070-1236	IW01-27	-
92070-1251	X16EPR-U9	-
92070-1270	IW24	-
92070-1272	IW31	-
92070-1275	IW01-24	-
92070-3704	IW01-27	-
E920701034	X27ESR-U	-
E920701155	U24FSR-U	-
J4520IU0124	IU01-24	-
J4520IU0127	IU01-27	-
J4520IU0131	IU01-31	-
J4520IU0134	IU01-34	-
J4520IU22	IU22	-
J4520IU24	IU24	-
J4520IU24A	IU24A	-
J4520IU27	IU27	-
J4520IU27A	IU27A	-
J4520IU31	IU31	-
J4520IU31A	IU31A	-
J4520IUF22	IUF22	-
J4520IUF24	IUF24	-
J4520IUH24	IUH24	-
J4520IUH27	IUH27	-
J4520IW0124	IW01-24	-
J4520IW0127	IW01-27	-
J4520IW0129	IW01-29	-
J4520IW0131	IW01-31	-
J4520IW0132	IW01-32	-
J4520IW0134	IW01-34	-
J4520IW16	IW16	IW16TT
J4520IW20	IW20	IW20TT
J4520IW22	IW22	-
J4520IW24	IW24	-
J4520IW27	IW27	-
J4520IW29	IW29	-
J4520IW31	IW31	-
J4520IW34	IW34	-
J4520IWF22	IWF22	-
J4520IWF24	IWF24	-
J4520IWF27	IWF27	-
J4520IX22	IX22	-
J4520IX22B	IX22B	-
J4520IX24	IX24	-
J4520IX24B	IX24B	-
J4520IX27	IX27	-
J4520IX27B	IX27B	-
J4520IXU0127	IXU01-27	-
J4520IXU0131	IXU01-31	-
J4520IXU0134	IXU01-34	-
J4520IXU22	IXU22	-
J4520IXU24	IXU24	-
J4520U20FSRU	U20FSR-U	-
J4520U22ESRN	U22ESR-N	-
J4520U22FSRU	U22FSR-U	-
J4520U24ESRN	U24ESR-N	-
J4520U27ESRN	U27ESR-N	-
J4520U27ETR	U27ETR	-
J4520W20EPRU	W20EPR-U	W20TT
J4520W20EPU	W20EP-U	W20TT
J4520W20FPRU	W20FPR-U	WF20TT
J4520W22FPRU	W22FPR-U	-
J4520W24ESRU	W24ESR-U	-
J4520W24FSU10	W24FSR-U10	-
J4520W27ESRU	W27ESR-U	-

KAWASAKI	DENSO	TT
92070-036	W27FSR	-
92070-045-2	W24ESR-U	-
92070-1003	W22ESR-U	-
92070-1007	W20ESR-U	-
92070-1009	W24ESR-U	-
92070-1010	X24ESR-U	-
92070-1012	X22ESR-U	-
92070-1016	W24ESR-U	-
92070-1020	X24ESR-U	-
92070-1028	W20EPR-U	W20TT
92070-1029	W20EPR-U	W20TT
92070-1030	W22EPR-U	W22TT
92070-1031	W22EPR-U	W22TT
92070-1033	W24ESR-U	-
92070-1036	W22ESR-U	-
92070-1038	W24EPR-U	-
92070-1041	W20ESR-U	-
92070-1045	W16ESR-U	-
92070-1047	W27ESR-U	-
92070-1048	W16EPR-U	W16TT
92070-1049	W24EPR-U	-
92070-1050	W16ESR-U	-
92070-1051	W27ESR-U	-
92070-1052	W16EPR-U	W16TT
92070-1102	X24EPR-U9	-
92070-1103	X24EPR-U9	-
92070-1104	X27EPR-U9	-
92070-1105	X27EPR-U9	-
92070-1110	X27ESR-U	-
92070-1112	X27ESR-U	-
92070-1117	X22ESR-U	-
92070-1120	X22EPR-U9	-
92070-1121	X22EPR-U9	-
92070-1127	U16FSR-U	-
92070-1128	U20FSR-U	-
92070-1129	U22FSR-U	-
92070-1135	U24FSR-U	-
92070-1137	X20EPR-U9	-
92070-1139	X20EPR-U9	-
92070-1143	U27ESR-N	-
92070-1144	U27ES-N	-
92070-1145	U27ETR	-
92070-1147	X20ESR-U	-
92070-1148	U27ESR-N	-
92070-1150	U27ES-N	-
92070-1151	U27ESR-N	-
92070-1156	W22FPR-U	-
92070-1158	U24ETR	-
92070-1159	U27ETR	-
92070-1160	U24ETR	-
92070-1162	X20ESR-U	-
92070-1169	U24ESR-N	-
92070-1170	U24ES-N	-

KAWASAKI	DENSO	TT
J4520W27ESU	W27ESR-U	-
J4520W31ESRU	W31ESR-U	-
J4520X20EPRU9	X20EPR-U9	-
J4520X20FSU	X20FSR-U	-
J4520X22EPRU9	X22EPR-U9	-
J4520X24EPRU9	X24EPR-U9	-
J4520X24EPU9	X24EPR-U9	-
J4520X24ESRU	X24ESR-U	-
J4520X24ESU	X24ESR-U	-
J4520-X24GP-U	X24GPR-U	-
J4520X27EPRU9	X27EPR-U9	-

KIA	DENSO	TT
0K05418140	DG-146	-
0K20W18110	W16EPR-U11	W16TT
0K71018140	DG-146	-
0K71018140A	DG-146	-
0K75A18140	DG-146	-
0K75B18140	DG-146	-
18846-10060	VXUH20I	-
AA13A18110	P16PR11	W16TT
K01118110	K16PR-U	K16TT
K01318110	K20PR-U11	K20TT
K01A18110	K16PR-U	K16TT
K01C18100	K20PR-U11	K20TT
K01C18110	K20PR-U11	K20TT
K05418140	DG-146	-
K066018110	W16EXR-U	W16TT
K1DC18110	K16PR-U11	K16TT
K20W18110	W16EPR-U11	W16TT
K2A118110	W16EXR-U11	W16TT
K2AA18100	K20PR-U	K20TT
K2AA18110	K20PR-U11	K20TT
K55818110	PK20PR-L11	IK20TT
K71018140	DG-146	-
K71018140A	DG-146	-
K75A18140	DG-146	-
K75B18140	DG-146	-
K9A718110	K20PR-U	K20TT
KB60118110	W16EPR-U11	W16TT
KK15018110	W16EPR-U11	W16TT
KKY0118110	W16EPR-U11	W16TT

KOMATSU	DENSO	TT
2240158000	W14EX-U	IW16TT
2240158001	W16ES-U	-
60081-51350	DG-234	-
TJ9009809125	W9EP	-
TJ9091901055	W9EP	-

KUBOTA	DENSO	TT
0790923150	W20MR-U	-
0790923160	W22M-U	-
1020267711	MW17	-
1264767710	W20FPR-U	WF20TT
1268167740	W16ESR-U	-
1307867710	W20EP-U	W20TT
1310167711	W16S-U	-
1315767710	W14MR-U	-
1317367711	W14F-U	-
1321167711	W14PR-U	-
1328167711	W14F-U	-
1330267710	W9-U	-
1337567740	W14FPR-UL10	-
1340367711	W20S-U	-
1341267710	W22S-U	-
1345167712	W20FSR-U	WF20TT
1358167710	W22FS-U	-
1371167711	W14PR-U	-
1374267711	W14FPR-UL10	-
1390167712	W20FPR-U	WF20TT

KUBOTA	DENSO	TT
1390267711	W20FPR-U	WF20TT
15694-65512	DG-157	-
15694-65513	DG-157	-

LADA	DENSO	TT
2101037070	W20EPR-U	W20TT
210137000	W20EPR-U	W20TT
21013707	W20EPR-U	W20TT
2101-3707000-02	W20EPR-U	W20TT
2101-3707000-60	W20EP-U	W20TT
21013707001	W20EPR-U	W20TT
210837000	W20EPR-U	W20TT
2108370701	W20EPR-U	W20TT
21083707010	W20EPR-U	W20TT
2108-3707010-10	W20EPR-U	W20TT
2108-3707010-12	W20EPR-U	W20TT
211137000	Q20PR-U11	Q20TT
2111370701	W20EPR-U	W20TT
21113707010	W20EPR-U	W20TT
2111-3707010-01	W20EPR-U	W20TT
211237000	Q20PR-U11	Q20TT
2112370701	W20EPR-U	W20TT
2112-3707010-01	W20EPR-U	W20TT
212153740010	DG-001	-

LANCIA	DENSO	TT
4079729	IW20	IW20TT
46481273	XU24EPR-U	-
4896406	DG-001	-
7554442	W20EPR-U	W20TT
9151989280	T20EPR-U	T20TT

LAND ROVER	DENSO	TT
1354289	DG-140	-
4550157	SK16PR-A11	IK16TT
CYFS12YPC	ITV22	-
ERC8450	DG-001	-
ERC8648	DG-202	-
ERR3799	W16EXR-U	W16TT
ERR6066	DG-182	-
ETC8847	DG-115	-
LANDB0003	PK16PR-L11	IK16TT
LR001302	DG-614	-
LR002535	PK20PR-L11	IK20TT
LR004377	DG-130	-
LR005253	SK16PR-A11	IK16TT
LR005483	VKH20Y	-
LR019484	VFxEH20	IXEH20TT
LR021006	K20TXR	K20TT
LR025605	ITV22	-
NCC100050L	DG-101	-
NCC100120L	DG-145	-
NLP10003	K20PR-U	K20TT
NLP100190	K20PR-U11	K20TT
NLP100290L	PK20PR-L11	IK20TT
NLP100320	PK16PR-L11	IK16TT
NPL000030	K20TXR	K20TT
RTC3569	W20ESR-U	-
RTC3570	W16EPR-U	W16TT
RTC3812	W20EP-U	W20TT
STC2223	DG-001	-
STC3103	DG-001	-

LDV	DENSO	TT
5961.58	DG-001	-

LOTUS	DENSO	TT
A100E6277S	K20PR-U	K20TT
A910E7009F	W20ETR-L	IW20TT
A918E6039F	K20TNR	K20TT
AE100E6277S	IK20	IK20TT

Spark & Glow Plugs

Cross Reference Chart - OE

LOTUS	DENSO	TT
LOTUB0001	W20ETR-L	IW20TT
PS304017621AF	K20P-U	K20TT

MASERATI	DENSO	TT
CND96596	W24EPR-U	-
CND96875	XU24EPR-U	-
CND97219	XU27EPR-U	-

MASSEY-FERGUSON	DENSO	TT
1060024MI	ITF16	ITF16TT
834225MI	W14-US	-
834230MI	W14-US	-
834232MI	W9-U	-
834234MI	IWF16	-
834236MI	W16EPR-U	W16TT
834237MI	MA16PR-U	-
834241MI	MA16PR-U	-
834245MI	L14-U	-
834247MI	IWF16	-
834248MI	MA20PR-U	-

MAZDA	DENSO	TT
00001010GV	IW31	-
00001011GV	IW34	-
0000108GV	IW24	-
0000109GV	IW27	-
000010BKR7	K22PR-U11	-
000010R105	IRE01-32	-
000010R11	IRE01-34	-
000010R54008	IK24	-
000010R54009	IK01-27	-
04181810A	W22ESR-U	-
074418110	W22EP-U	W22TT
0802 18 600	W22EBR	-
080218600	W22EBR	-
100277550	W16EXR-U	W16TT
100377550	W20EX-U	W20TT
140918110	W16EXR-U13	W16TT
141018110	W16EXR-U13	W16TT
153418110	W16EXR-U	W16TT
169018110	W20EPR-U	W20TT
18BP01	K16PR-U11	K16TT
18BP03	K20PR-U11	K20TT
1A0118110	P16PR11	W16TT
1A0218110	IXU22	-
1A0318110	VXU22	-
1A1018110	IW16	IW16TT
1A1118110	IXU22	-
1A1218110	SXU22HDR8	-
1A1318110	IXU22HPR	-
1A6118110	IXU22	-
1E0318110	PT16EPR-L13	IT16TT
1E0418110	PT16EPR-L13	IT16TT
1E0518110	PT16VR10	TV16TT
1E0618110	PT16VR10	TV16TT
1E07 18 601	DG-007	-
1E07 18 601B	DG-007	-
1N0418110	K16R-U11	K16TT
1N0818110	PK16PR-L11	IK16TT
1N1418110	FXE16HE11	-
1N1918110	FXE20HR11	IXEH20TT
1N2418110	FXE20HE11	IXEH20ETT
1N2518110	FXE20HE11	IXEH20ETT
1UD018110	IW16	IW16TT
1UD118110	IW20	IW20TT
1UD218110	IW22	-
1UD318110	IK16	IK16TT
1UD418110	IK20	IK20TT
1UD618110	IQ16	IQ16TT
1UD718110	IQ20	IQ20TT
1UD918110	IXU22	-

MAZDA	DENSO	TT
1UN018110	IW16	IW16TT
1UN118110	IW20	IW20TT
1UN218110	IW22	-
1UN318110	IW16	IW16TT
1UN418110	IW20	IW20TT
1UN618110	IK16	IK16TT
1UN718110	IK20	IK20TT
1UN918110	IK16	IK16TT
1UNA18110	IK20	IK20TT
1UNC18110	IQ16	IQ16TT
1UND18110	IQ20	IQ20TT
1UNF18110	IXU22	-
1UNG18110	IK16L	IK16TT
1UNH18110	KJ20SR11	IK20TT
1UTO18110	VW16	IW16TT
1UT118110	VW20	IW20TT
1UT218110	VW22	-
1UT318110	VK16	IK16TT
1UT418110	VK20	IK20TT
1UT618110	VQ16	IQ16TT
1UT718110	VQ20	IQ20TT
1UT918110	VXU22	-
1UX018110	VW16	IW16TT
1UX118110	VW20	IW20TT
1UX318110	VW16	IW16TT
1UX418110	VW20	IW20TT
1UX618110	VK16	IK16TT
1UX718110	SVK20RZ8	IK20TT
1UX718110	VK20Y	-
1UX918110	VK16	IK16TT
1UXA18110	VK20	IK20TT
1UXC18110	PQ16R	Q16TT
1UXD18110	PQ20R	Q20TT
1UXF18110	VXU22	-
1UXG18110	PKJ16CR-L11	IK16TT
1UXH18110	IK20L	IK20TT
1UXJ18110	VT16	IT16TT
1WT118110	W16TT	W16TT
1WT318110	K20TT	K20TT
1WT418110	XU22TT	XU22TT
1WT518110	XUH22TT	XUH22TT
22218110	W20EXR-U	W20TT
30418110	W20EPR-U	W20TT
364818600	W22EBR	-
364918600	W27EBR	-
371018110	W20EXR-U11	W20TT
395318110	W16EXR-U	W16TT
395418110	W20EXR-U	W20TT
407518110	W14EPR-U	IW16TT
409518110	W14EX-U	IW16TT
409618110A	W14EXR-U11	IW16TT
41918110	W22ESR-U	-
42018110	W24ESR-U	-
488218110	W9EP	-
488418110	W9EXR-U+CU	-
66018110	W16EPR-U	W16TT
74524210	W20EPR-U	W20TT
804218110	W20EXR-U11	W20TT
834418600	W27EBR	-
86618600	W22EBR	-
981418110	W16EXR-U	W16TT
A50218110	W20EPR-U	W20TT
AJ0318110	T16EPR-U15	T16TT
AJ09 18 110B	T16EPR-U15	T16TT
AJ0918110	T16EPR-U15	T16TT
AYFS22FM	ITV22	-
AZ0818110	W16EPR-U	W16TT
AZ0918110	W16EPR-U	W16TT
AZ2818110	IXU22	-
AZ2918110	IXU22	-
B60118110	W16EXR-U11	W16TT

MAZDA	DENSO	TT
B60218110	W16EXR-U11	W16TT
B64N18110	J16AR-U11	-
B64P18110	J16AR-U11	-
B66018110	Q20P-U11	Q20TT
B66718110	Q20P-U11	Q20TT
B67318110	W16EXR-U	W16TT
B69518110	Q20PR-U	Q20TT
B69618110	Q20PR-U	Q20TT
B6B318110	Q16PR-U11	Q16TT
B6B418110	Q16PR-U11	Q16TT
BP0118110	K16PR-U11	K16TT
BP0218110	K16PR-U11	K16TT
BP0318110	K20PR-U11	K20TT
BP0418110	K20PR-U11	K20TT
BP0518110	K22PR-U11	-
BP0618110	K22PR-U11	-
BP1118110	K16PR-U11	K16TT
BP1218110	K16PR-U11	K16TT
BP1318110	K16PR-U11	K16TT
BP1318110A	K16PR-U11	K16TT
BP1418110	K20PR-U11	K20TT
BP4718110	K16PR-U	K16TT
BP4818110	K16PR-U	K16TT
BP4918110	K20PR-U	K20TT
BP5018110	K20PR-U	K20TT
BP8J18110	VK20	IK20TT
BP8K18110	VK16	IK16TT
BPY118110	K16PR-U11	K16TT
BPY218110	K16PR-U11	K16TT
BPY418110	K20PR-U11	K20TT
C00118110	PT16VR13	TV16TT
CY0118110	ITV22	-
E35618110	J16AR-U11	-
E35718110	J16AR-U11	-
E55218110	W16EXR-U	W16TT
F20118110	QJ20CR11	Q20TT
F20218110A	QJ20CR11	Q20TT
F20318110	KJ16CR11	K16TT
F20418110	QJ16CR11	Q16TT
F20518110	KJ22CR-L11	-
F21018110	Q16PR-U	Q16TT
F21118110	Q16PR-U	Q16TT
F22018110	Q20PR-U11	Q20TT
F22118110	Q20PR-U11	Q20TT
F28518110	KJ20CR-U11	K20TT
F28618110	KJ20CR-U11	K20TT
F28718110	KJ16CR-U11	K16TT
F28818110	KJ16CR11	K16TT
F29018110	KJ22CR-L11	-
F29318110	KJ16CR-U11	K16TT
F2SK18110	W9EXR-U+CU	-
F2Y218110	KJ16CR11	K16TT
F8L618110	KJ14CR11	-
F8L718110	KJ14CR11	-
F8L818110	W14EXR-U11	IW16TT
F8L918110	W14EXR-U11	IW16TT
FE6F18110	Q22PR-U11	-
FE7918110	W20EPR-U11	W20TT
FE8218110	W20EXR-U11	W20TT
FEDK18110	W16EXR-U13	W16TT
FEDM18110	W16EXR-U13	W16TT
FEEG18110	W20EXR-U11	W20TT
FEH18110	W20EXR-U11	W20TT
GY0118110	IT16	IT16TT
GY0218110	IT16	IT16TT
H28818110	KJ16CR11	K16TT
IA1118110	IXU22	-
IA5018110	K20PR-U	K20TT
JE0318110	Q22PR-U	-
JE0418110	Q22PR-U	-
JE2618110	IK20	IK20TT

MAZDA	DENSO	TT
JE2818110	IQ16	IQ16TT
JE4118110	IK16	IK16TT
JE4218110	IK16	IK16TT
JE4318110	IK20	IK20TT
JE4418110	K20PR-TP11	K20TT
JF0318110	Q16PR-U11	Q16TT
JF0418110	Q16PR-U11	Q16TT
KJ1118110	PKJ20CR8	-
KJ1218110	PKJ20CR8	-
KJ1318110	PKJ16CR8	-
KJ1418110	PKJ16CR8	-
KJ1718110	PKJ16CR8	-
KJ1818110	PKJ20CR8	-
L30318110	VT16	IT16TT
L34118110	ZT20EPR11	T20TT
L3BD 18 110	ITV22	-
L3G218110	ITV20	ITV20TT
L3K9 18 110A	ITV22	-
L3K918110A	ITV20	ITV20TT
L3Y118110	ITV20	ITV20TT
L3Y218110	ITV16	ITV16TT
L3Y3 18 110	ITV22	-
L3Y318110	ITV20	ITV20TT
L3Y418110	ZT20EPR11	T20TT
L3YD 18 110	ITV22	-
L81318110	ZT20EPR11	T20TT
L81418110	T20EPR-U15	T20TT
L84518110	VT16	IT16TT
LF6118110	ITV16	ITV16TT
LFJD18110	ITV16	ITV16TT
LFJR18110	ITV20	ITV20TT
LFY118110	T16VR-U10	TV16TT
LFY118110	VT16	IT16TT
LFY318110	T16EPR-U15	T16TT
MAZDB0001	KJ20CR-U11	K20TT
N22918600	IRE01-27	-
N24518600	IRE01-31	-
N24618600	IRE01-27	-
N25318600	IRE01-27	-
N31818110	S-31A	-
N31918110	IRE01-31	-
N33318110	S-31A	-
N33818110	S-31A	-
N34218110	IRE01-27	-
N34318110	IRE01-27	-
N3A118110	IRE01-27	-
N3A218110	IRE01-27	-
N3H818110A	IRT01-31	-
N3Y118110	IRT01-31	-
N3Y118110A	IRT01-31	-
N3Y418110A	IRT01-31	-
N3Z118110A	IRL01-27	-
N3Z218110A	IRL01-27	-
N3Z518110	IRL01-27	-
PE01 18 110	VFXEH22	IXEH22TT
PE02 18 110	VFXEH22	IXEH22TT
PE55 18 110	VCH20	IXEH22TT
PE5R 18 110	VCH20	IXEH22TT
PN11 18 601	DG-311	-
R2L2 18 601	DG-104	-
RF1M 18 601	DG-146	-
RF2A 18 601	DG-502	-
RF61 18 601	DG-146	-
RFJ5 18 601	DG-146	-
RFN1 18 601	DG-146	-
RFP1 18 601	DG-501	-
S201 18 140	DG-114	-
S210 18 140	DG-146	-
S501 18 140A	DG-114	-
VS01 18 601	DG-104	-
WL03 18 601	DG-146	-

Spark & Glow Plugs

Cross Reference Chart - OE

MAZDA	DENSO	TT
WL81 18 601	DG-146	-
WLE7 18 601	DG-311	-
Y401 18 601	DG-113	-
Y401 18 601A	DG-113	-
Y404 18 601	DG-180	-
Y404 18 601A	DG-180	-
Y650 18 601	DG-603	-
YF1018110	PT16VR13	TV16TT
Z60118110	SK16PR-E11	IK16TT
Z6B718110	IK16	IK16TT
ZJ4618110	SK16PR-E11	IK16TT
ZJV618110	SK16PR-E11	IK16TT
ZM0118110	SKJ16CR-A8	-
ZM0218110	SKJ20CR-A8	-
ZY51 18 110	VFK16	IK16TT
ZYY1 18 110	VFK16	IK16TT
ZZ3318110	J16CR-U	W16TT
ZZC2 18 110	PT16EPR-L13	IT16TT
ZZC218110A	PT16EPR-L13	IT16TT
ZZJ118110	ITV22	-
ZZS118110	XU22EPR-U	XU22TT
ZZS218110	XU22EPR-U	XU22TT
ZZS418110	J16CR-U	W16TT

MERCEDES-BENZ	DENSO	TT
1021590003	T20EPR-U	T20TT
1031590003	T20EPR-U	T20TT
1101590003	W20EPR-U	W20TT
11590001	DG-001	-
11590201	DG-001	-
11590803	W22EPR-U	W22TT
11591303	W22EPR-U	W22TT
11591501	DG-119	-
11591503	W22EPR-U	W22TT
11591601	DG-119	-
11591603	W22EPR-U	W22TT
11591701	DG-001	-
11592001	DG-117	-
11592101	DG-106	-
11592201	DG-001	-
11592601	DG-110	-
11592701	DG-155	-
11592801	DG-117	-
11593601	DG-001	-
11593701	DG-117	-
11593801	DG-117	-
11594201	DG-117	-
11594610	DG-606	-
11594801	DG-117	-
11594901	DG-117	-
11595001	DG-194	-
11595101	DG-192	-
11595201	DG-192	-
11597101	DG-194	-
11598703	W22EPR-U	W22TT
11599303	W22EPR-U	W22TT
1161590003	W20EPR-U	W20TT
1161590103	W20EPR-U	W20TT
1231590003	W22EPR-U	W22TT
1500281	DG-010	-
1594901	DG-117	-
1597501	DG-001	-
1597701	DG-001	-
1598101	DG-001	-
1598201	DG-001	-
1598301	DG-001	-
1599601	DG-001	-
1599901	DG-001	-
21591803	W22EPR-U	W22TT
21592203	W16EPR-U	W16TT
21592403	W20EPR-U	W20TT

MERCEDES-BENZ	DENSO	TT
21592703	W22EPR-U	W22TT
21592803	W20EPR-U	W20TT
21592903	W16EPR-U	W16TT
21593103	W16EPR-U	W16TT
21594103	W20EPR-U	W20TT
21594203	W20EPR-U	W20TT
21594803	W16EPR-U	W16TT
21594903	T20EPR-U	T20TT
21595603	T20EPR-U	T20TT
21595703	T16EPR-U	T16TT
21595803	T16EPR-U	T16TT
21596203	W22EPR-U	W22TT
21596403	T22EP-U	-
21596503	T22EP-U	-
21596603	T20EPR-U	T20TT
21596703	T22EP-U	-
21596803	T20EPR-U	T20TT
21596903	T20EPR-U	T20TT
21597603	T20EPR-U	T20TT
21597703	Q16R-U	Q16TT
21597803	T16EPR-U	T16TT
31590403	PK16PR-L11	IK16TT
31590503	T16EPR-U	T16TT
31590603	T20EPR-U	T20TT
31590703	T20EPR-U	T20TT
31590803	T22EP-U	-
31591003	W16EPR-U	W16TT
31591103	W16EPR-U	W16TT
31591203	W20EPR-U	W20TT
31591303	W20EPR-U	W20TT
31591403	W22EPR-U	W22TT
31591603	Q20R-U	Q20TT
31592303	T20EPR-U	T20TT
31592403	T16EPR-U	T16TT
31592503	T22EP-U	-
31592603	W20EPR-U	W20TT
31592703	W16EPR-U	W16TT
31592803	T16EPR-U	T16TT
31592903	W16EPR-U	W16TT
31593003	Q16R-U	Q16TT
31593103	Q20R-U	Q20TT
31593203	W22EPR-U	W22TT
31593303	T22EP-U	-
31593403	T20EPR-U	T20TT
31593503	T20EPR-U	T20TT
31593603	T16EPR-U	T16TT
31593703	Q16R-U	Q16TT
31594003	K20PR-U	K20TT
31594103	K16PR-U11	K16TT
31594203	Q16R-U	Q16TT
31594503	W20EPR-U	W20TT
31594603	W20PR-U	-
31594703	W16EPR-U	W16TT
31595303	K16PR-U	K16TT
31595403	Q16PR-U11	Q16TT
31595603	W22EPR-U	W22TT
31595703	W20EPR-U	W20TT
31595803	W22EPR-U	W22TT
31595903	T22EP-U	-
31596003	K20P-U	K20TT
31596503	K20PBR-S10	K20TT
31596603	PK16PR-L11	IK16TT
31596703	Q16PR-U11	Q16TT
31596803	K16PR-U11	K16TT
31597103	K16PR-U	K16TT
31597203	K20PBR-S10	K20TT
31597303	K20PBR-S10	K20TT
31597503	K20PBR-S10	K20TT
3159750326	K20PBR-S10	K20TT
31597603	K20PBR-S10	K20TT
31597803	K20PBR-S10	K20TT

MERCEDES-BENZ	DENSO	TT
31598003	SK20PR-L9	IK20TT
31598103	PK16PR-L11	IK16TT
31598603	PK16PR-L11	IK16TT
31599003	K20PBR-S10	K20TT
31599103	K20TXR	K20TT
31599203	K20TXR	K20TT
31599403	PK16PR-L11	IK16TT
3159940326	VK16	IK16TT
31599603	SK16PR-A11	IK16TT
3159960326	SK16PR-A11	IK16TT
31599703	SK20PR-L9	IK20TT
3159970326	SK20PR-L9	IK20TT
4151590001	DG-609	-
41590203	SK20PR-L9	IK20TT
41590703	SK20PR-L9	IK20TT
41590903	PK16PR-L11	IK16TT
41591303	VKH20	IKH20TT
41591403	SVK20RZ8	IK20TT
4159140326	SVK20RZ8	IK20TT
4159140326	VK20Y	-
41591803	SKX22HDR8	-
4159180326	VXUH22	-
41591903	PK16PR-L11	IK16TT
41592003	PK20PR11	K20TT
4159200326	PK20PR11	K20TT
41592303	VKH20	IKH20TT
41592503	VXUH22I	-
41592603	K20PR-U	K20TT
41593003	K20PR-U11	K20TT
41593403	SKX22HDR8	-
41593603	K20PR-U11	K20TT
41593903	VFXEH22	IKXEH22TT
41594303	VK20	IK20TT
4159430326	VK20	IK20TT
41594403	VXUH22	-
4159440326	VXUH22	-
41594503	VKH20	IKH20TT
41594903	SKX22HDR8	-
41595003	PK16PR-L11	IK16TT
41595803	VXUH22	-
6601590001	DG-184	-
A0001500281	DG-010	-
A0001594901	DG-117	-
A0001597501	DG-001	-
A0001597701	DG-001	-
A0001598101	DG-001	-
A0001598201	DG-001	-
A0001598301	DG-001	-
A0001599601	DG-001	-
A0001599901	DG-001	-
A0011590001	DG-001	-
A0011590201	DG-001	-
A0011590803	W22EPR-U	W22TT
A0011591303	W22EPR-U	W22TT
A0011591501	DG-119	-
A0011591503	W22EPR-U	W22TT
A0011591601	DG-119	-
A0011591603	W22EPR-U	W22TT
A0011591701	DG-001	-
A0011592001	DG-117	-
A0011592101	DG-106	-
A0011592201	DG-001	-
A0011592601	DG-110	-
A0011592701	DG-155	-
A0011592801	DG-117	-
A0011593601	DG-001	-
A0011593701	DG-117	-
A0011593801	DG-117	-
A0011594201	DG-117	-
A0011594610	DG-606	-

MERCEDES-BENZ	DENSO	TT
A0011594801	DG-117	-
A0011594901	DG-117	-
A0011595001	DG-194	-
A0011595101	DG-192	-
A0011595201	DG-192	-
A0011597101	DG-194	-
A0011598703	W22EPR-U	W22TT
A0011599303	W22EPR-U	W22TT
A0021591803	W22EPR-U	W22TT
A0021592203	W16EPR-U	W16TT
A0021592403	W20EPR-U	W20TT
A0021592703	W22EPR-U	W22TT
A0021592803	W20EPR-U	W20TT
A0021592903	W16EPR-U	W16TT
A0021593103	W16EPR-U	W16TT
A0021594103	W20EPR-U	W20TT
A0021594203	W20EPR-U	W20TT
A0021594803	W16EPR-U	W16TT
A0021594903	T20EPR-U	T20TT
A0021595603	T20EPR-U	T20TT
A0021595703	T16EPR-U	T16TT
A0021595803	T16EPR-U	T16TT
A0021596203	W22EPR-U	W22TT
A0021596403	T22EP-U	-
A0021596503	T22EP-U	-
A0021596603	T20EPR-U	T20TT
A0021596703	T22EP-U	-
A0021596803	T20EPR-U	T20TT
A0021596903	T20EPR-U	T20TT
A0021597603	T20EPR-U	T20TT
A0021597703	Q16R-U	Q16TT
A0021597803	T16EPR-U	T16TT
A0031590403	PK16PR-L11	IK16TT
A0031590503	T16EPR-U	T16TT
A0031590603	T20EPR-U	T20TT
A0031590703	T20EPR-U	T20TT
A0031590803	T22EP-U	-
A0031591003	W16EPR-U	W16TT
A0031591103	W16EPR-U	W16TT
A0031591203	W20EPR-U	W20TT
A0031591303	W20EPR-U	W20TT
A0031591403	W22EPR-U	W22TT
A0031591603	Q20R-U	Q20TT
A0031592303	T20EPR-U	T20TT
A0031592403	T16EPR-U	T16TT
A0031592503	T22EP-U	-
A0031592603	W20EPR-U	W20TT
A0031592703	W16EPR-U	W16TT
A0031592803	T16EPR-U	T16TT
A0031592903	W16EPR-U	W16TT
A0031593003	Q16R-U	Q16TT
A0031593103	Q20R-U	Q20TT
A0031593203	W22EPR-U	W22TT
A0031593303	T22EP-U	-
A0031593403	T20EPR-U	T20TT
A0031593503	T20EPR-U	T20TT
A0031593603	T16EPR-U	T16TT
A0031593703	Q16R-U	Q16TT
A0031594003	K20PR-U	K20TT
A0031594103	K16PR-U11	K16TT
A0031594203	Q16R-U	Q16TT
A0031594503	W20EPR-U	W20TT
A0031594603	W20PR-U	-
A0031594703	W16EPR-U	W16TT
A0031595303	K16PR-U	K16TT
A0031595403	Q16PR-U11	Q16TT
A0031595603	W22EPR-U	W22TT
A0031595703	W20EPR-U	W20TT
A0031595803	W22EPR-U	W22TT
A0031595903	T22EP-U	-
A0031596003	K20P-U	K20TT

Spark & Glow Plugs

Cross Reference Chart - OE

MERCEDES-BENZ	DENSO	TT
A0031596503	K20PBR-S10	K20TT
A0031596603	PK16PR-L11	IK16TT
A0031596703	Q16PR-U11	Q16TT
A0031596803	K16PR-U11	K16TT
A0031597103	K16PR-U	K16TT
A0031597203	K20PBR-S10	K20TT
A0031597303	K20PBR-S10	K20TT
A0031597503	K20PBR-S10	K20TT
A0031597603	K20PBR-S10	K20TT
A0031597803	K20PBR-S10	K20TT
A0031598003	SK20PR-L9	IK20TT
A0031598103	PK16PR-L11	IK16TT
A0031598603	PK16PR-L11	IK16TT
A0031599003	K20PBR-S10	K20TT
A0031599103	K20TXR	K20TT
A0031599203	K20TXR	K20TT
A0031599403	PK16PR-L11	IK16TT
A003159940326	VK16	IK16TT
A0031599603	SK16PR-A11	IK16TT
A0031599703	SK20PR-L9	IK20TT
A003159970326	SK20PR-L9	IK20TT
A0041590203	SK20PR-L9	IK20TT
A0041590703	SK20PR-L9	IK20TT
A0041590903	PK16PR-L11	IK16TT
A0041591303	VKH20	IKH20TT
A0041591403	SVK20RZ8	IK20TT
A0041591403	VK20Y	-
A004159140326	SVK20RZ8	IK20TT
A004159140326	VK20Y	-
A0041591803	SXU22HDR8	-
A004159180326	VXUH22	-
A0041591903	PK16PR-L11	IK16TT
A0041592003	PK20PR11	K20TT
A004159200326	PK20PR11	K20TT
A0041592303	VKH20	IKH20TT
A0041592503	VXUH22I	-
A0041592603	K20PR-U	K20TT
A0041593003	K20PR-U11	K20TT
A0041593403	SXU22HDR8	-
A0041593603	K20PR-U11	K20TT
A0041593903	VFXEH22	IKXEH22TT
A0041594303	VK20	IK20TT
A004159430326	VK20	IK20TT
A0041594403	VXUH22	-
A004159440326	VXUH22	-
A0041594503	VKH20	IKH20TT
A0041594903	SXU22HDR8	-
A0041595003	PK16PR-L11	IK16TT
A0041595803	VXUH22	-
A1021590003	T20EPR-U	T20TT
A1031590003	T20EPR-U	T20TT
A1101590003	W20EPR-U	W20TT
A1161590003	W20EPR-U	W20TT
A1161590103	W20EPR-U	W20TT
A1231590003	W22EPR-U	W22TT
A4151590001	DG-609	-
A6601590001	DG-184	-

MERCURUISER	DENSO	TT
3337405	W20ESR-U	-
333854400	T20R-U	-
3354527	W20ESR-U	-
3359571	T20R-U	-
3360056	W20ESR-U	-
338134711	W20ESR-U	-
33816336	W20EPR-U	W20TT
33979826	T20R-U	-

MG	DENSO	TT
GSP9662	PK20PR-L11	IK20TT
NLP000090	PK20PR-L11	IK20TT

MG	DENSO	TT
NLP000130	PK20PR-L11	IK20TT

MINI	DENSO	TT
12120034097	VXUH22	-
12120035933	VXUH22	-

MITSUBISHI	DENSO	TT
1822A002	SK20PR-A8	IK20TT
1822A005	VKH20	IKH20TT
1822A009	XU22HDR9	XUH22TT
1822A010	SXU22HDR8	-
1822A011	SXU22HDR8	-
1822A022	VKH22	-
1822A030	K16PSR-B8	IK16TT
1822A036	XU22HDR9	XUH22TT
1822A061	FXU22HR11	-
1822A064	FXU22HR8	-
1822A068	VFK16	IK16TT
1822A069	VFK20F	IK20TT
1822A071	VFKH20	IKH20TT
1822A075	VKH20	IKH20TT
1822A085	VFKH16	IKH16TT
1822A086	VKH16	IKH16TT
1822A088	IXUH20I	-
1822A089	IXUH20I	-
CLP37201	K16TT	K16TT
CLP37202	K20TT	K20TT
CLP37203	XU22TT	XU22TT
CLP37204	XUH22TT	XUH22TT
CLP37205	W16TT	W16TT
M04671057	IK20	IK20TT
M05269897	W20EPR-U	W20TT
M05269899	W20EXR-U11	W20TT
M816732	DG-012	-
M883828	DG-005	-
MA848593	IKH20	IKH20TT
MD014997	DG-162	-
MD050212	DG-198	-
MD077167	DG-301	-
MD082832	DG-301	-
MD092392	DG-301	-
MD197511	DG-174	-
MD301950	DG-174	-
MD310294	K20PR-U11	K20TT
MD313443	PK20PR11	K20TT
MD314766	IK22	-
MD319586	IK22	-
MD320543	IK22	-
MD321150	K20TNR	K20TT
MD322771	PK20PR11	K20TT
MD336367	PKJ20CR8	-
MD338991	P22PR8	-
MD343244	P22PR8	-
MD343277	P20PR11	W20TT
MD344180	K16PR-U11	K16TT
MD344460	DG-174	-
MD344469	DG-174	-
MD348296	VKB16	-
MD350291	K20PR-U11	K20TT
MD351467	VKA16	-
MD354500	DG-174	-
MD355067	VKA20	-
MD357531	VW20	IW20TT
MD358200	KJ20CR-U11	K20TT
MD358202	KJ20CR-U11	K20TT
MD360019	VKB20	-
MD360383	VKB16	-
MD361067	SK16PR-A11	IK16TT
MD362097	KJ16CR-U11	K16TT
MD362098	KJ16CR-U11	K16TT
MD362902	VKA16	-
MD363621	KJ16CR-U11	K16TT

MITSUBISHI	DENSO	TT
MD366819	VKA16	-
MD371434	S22PR-A7	-
MD371435	S22PR-A7	-
MD372421	VKA16	-
MD372422	VKA20	-
MD372553	SK16PR-A11	IK16TT
MD372588	SK20PR-A11	IK20TT
MD373645	SK20PR-A11	IK20TT
MD374841	S22PR-A7	-
MD375642	VKA16	-
MD376962	PK16PR11	K16TT
MD378086	S22PR-A7	-
MD378582	SVK20RZ8	IK20TT
MD378582	VK20Y	-
MD851023	W20EP-U	W20TT
MD851332	PK20PR11	K20TT
ME200970	DG-306	-
ME201632	DG-306	-
ME201638	DG-306	-
ME202785	DG-306	-
ME203539	DG-187	-
ME203583	DG-306	-
ME203754	DG-306	-
ME205539	DG-187	-
ME220826	VK22	-
ME222165	VK22	-
ME300970	DG-306	-
MN119256	VKH16	IKH16TT
MN119487	SK20PR-A8	IK20TT
MN119489	VW20T	IW20TT
MN119500	VW20	IW20TT
MN119942	K20PBR-S10	K20TT
MN122257	SVK20RZ8	IK20TT
MN122257	VK20Y	-
MN122493	VXU22	-
MN122494	VXU22	-
MN128362	K20HR-U11	KH20TT
MN128363	IKH20	IKH20TT
MN137919	VKH20	IKH20TT
MN158596	IKH20	IKH20TT
MN158956	IKH20	IKH20TT
MN163235	K16PSR-B8	IK16TT
MN163236	SK20PR-A8	IK20TT
MN163807	K20PSR-B8	IK20TT
MN176628	IKH20	IKH20TT
MN960270	DG-606	-
MN960296	DG-606	-
MN980234	DG-190	-
MN982294	DG-614	-
MR577131	DG-174	-
MR984646	VK20Y	-
MR984943	SK20PR-A8	IK20TT
MS343277	P20PR11	W20TT
MS851021	W14EPR-U	W16TT
MS851022	W16EPR-U	W16TT
MS851023	W20EPR-U	W20TT
MS851024	W22EPR-U	W22TT
MS851025	W24EPR-U	-
MS851026	W14EPR-U	W16TT
MS851027	W16EPR-U11	W16TT
MS851028	W20EPR-U11	W20TT
MS851029	W22EPR-U11	W22TT
MS851097	W16EXR-U	W16TT
MS851098	W20EX-U	W20TT
MS851101	W14EX-U	W16TT
MS851102	W16EXR-U	W16TT
MS851104	W20EX-U	W20TT
MS851106	W14EXR-U11	W16TT
MS851107	W16EXR-U11	W16TT
MS851108	W20EXR-U11	W20TT
MS851126	W20EPR-U	W20TT

MITSUBISHI	DENSO	TT
MS851174	W22ESR-U	-
MS851181	W14EPR-U	W16TT
MS851182	W16EPR-U	W16TT
MS851183	W20EPR-U	W20TT
MS851184	W22EPR-U	W22TT
MS851187	W16EPR-U11	W16TT
MS851188	W20EPR-U11	W20TT
MS851189	W22EPR-U11	W22TT
MS851232	W16EPR-U	W16TT
MS851233	W20EPR-U	W20TT
MS851234	W22EPR-U	W22TT
MS851235	W16EPR-U	W16TT
MS851236	W20EPR-U	W20TT
MS851237	W16EXR-U11	W16TT
MS851238	W20EPR-U11	W20TT
MS851239	W22EPR-U11	W22TT
MS851243	W16EXR-U	W16TT
MS851253	W20EPR-S11	W20TT
MS851254	IW22	-
MS851272	W16EPR-U11	W16TT
MS851273	W20EPR-S11	W20TT
MS851274	IW22	-
MS851283	W20EP-U	W20TT
MS851292	P20PR11	W20TT
MS851302	P20PR11	W20TT
MS851316	XU20EPR-U	-
MS851317	XU22EPR-U	XU22TT
MS851328	IXU24	-
MS851332	PK20PR11	K20TT
MS851335	PK16PR-P11	K16TT
MS851336	PK20PR-P11	K20TT
MS851346	PK20PR-P8	IK20TT
MS851347	PK22PR8	-
MS851351	K16PR-U	K16TT
MS851352	K20P-U	K20TT
MS851357	K16PR-U11	K16TT
MS851358	K20PR-U11	K20TT
MS851359	K22PR-U11	-
MS851361	K16PR-U11	K16TT
MS851362	K20PR-U11	K20TT
MS851363	K22PR-U11	-
MS851367	K16PR-U	K16TT
MS851368	K20PR-U	K20TT
MS851377	K16PR-U11	K16TT
MS851378	IK20	IK20TT
MS851379	K22PR-U11	-
MS851402	W16EPR-U	W16TT
MS851403	W20EPR-U	W20TT
MS851407	W16EXR-U	W16TT
MS851408	W20EPR-U11	W20TT
MS851409	W22EPR-U11	W22TT
MS851411	W14EPR-U	W16TT
MS851412	W16EPR-U	W16TT
MS851413	W20EPR-U	W20TT
MS851414	W22EPR-U	W22TT
MS851417	W16EPR-U11	W16TT
MS851418	W20EPR-U11	W20TT
MS851419	W22EPR-U11	W22TT
MS851428	W20EPR-S11	W20TT
MS851429	IW22	-
MS851432	W16EPR-U11	W16TT
MS851433	W20EPR-U11	W20TT
MS851434	W22EPR-U11	W22TT
MS851435	IW16	W16TT
MS851437	W16EPR-U	W16TT
MS851438	W20EP-U	W20TT
MS851439	W22EPR-U	W22TT
MS851447	W20EPR-S11	W20TT
MS851448	W16EPR-U11	W16TT
MS851449	W20EPR-U11	W20TT
MS851454	W20EPR-U11	W20TT

Spark & Glow Plugs

Cross Reference Chart - OE

MITSUBISHI	DENSO	TT
MS851463	P20PR11	W20TT
MS851472	P16PR11	W16TT
MS851473	P20PR11	W20TT
MS851486	XU20EPR-U	-
MS851487	XU22EPR-U	XU22TT
MS851497	IXU22	-
MS851498	IXU24	-
MS851501	PK16PR-P11	K16TT
MS851502	PK20PR-P11	K20TT
MS851506	PK20PR-P8	IK20TT
MS851534	W20EPR-U11	W20TT
MS851540	W20EPR-U11	W20TT
MS851544	IW22	-
MS851550	W22EPR-U11	W22TT
MS851554	IW22	-
MS851572	K16PR-U11	K16TT
MS851623	W20EPR-U11	W20TT
MS851710	W14EPR-U	IW16TT
MS851718	W20EPR-U11	W20TT
MS851720	K16PR-U	K16TT
MS851721	K16PR-U	K16TT
MS851722	K20P-U	K20TT
MS851723	K20P-U	K20TT
MS851727	K16PR-U11	K16TT
MS851728	K20PR-U11	K20TT
MS851729	K22PR-U11	-
MS851731	K16PR-U11	K16TT
MS851732	K20PR-U11	K20TT
MS851733	W20EPR-U11	W20TT
MS851737	K16PR-U	K16TT
MS851738	K20PR-U	K20TT
MS851783	IK22	-
MS851792	W20ETR-L	IW20TT
MS851793	IW22	-
MS851861	PK20PR-P8	IK20TT
MS851872	IK22	-
MS851881	W20ETR-L	IW20TT
MS851882	W22ETR-L	-
MW30756065	DG-005	-
MY018551	W20EPR-U11	W20TT
MZ602020	IK16	IK16TT
MZ602021	IK20	IK20TT
MZ602022	IK22	-
MZ602023	IK24	-
MZ602024	IK27	-
MZ602025	IK31	-
MZ602026	IQ16	IQ16TT
MZ602027	IQ20	IQ20TT
MZ602028	IQ22	-
MZ602029	IQ24	-
MZ602030	IQ27	-
MZ602031	IQ31	-
MZ602032	IW16	IW16TT
MZ602033	IW20	IW20TT
MZ602034	IW22	-
MZ602035	IW24	-
MZ602036	IW27	-
MZ602037	IXU22	-
MZ602038	IXU24	-
MZ602039	IXU27	-
MZ602040	VK16	IK16TT
MZ602041	VK20	IK20TT
MZ602042	VK22	-
MZ602043	VQ16	IQ16TT
MZ602044	VQ20	IQ20TT
MZ602045	VQ22	-
MZ602046	VW16	IW16TT
MZ602047	VW20	IW20TT
MZ602048	VW22	-
MZ602049	VXU22	-
MZ602050	VXU24	-

MITSUBISHI	DENSO	TT
MZ602060	IW16	IW16TT
MZ602061	IW20	IW20TT
MZ602062	IW22	-
MZ602063	IQ16	IQ16TT
MZ602064	IQ20	IQ20TT
MZ602065	IK16	IK16TT
MZ602066	IK20	IK20TT
MZ602067	IXU22	-
MZ602068	IK16L	IK16TT
MZ602069	KJ20SR11	IK20TT
MZ602070	IW16	IW16TT
MZ602071	IW20	IW20TT
MZ602072	IK16	IK16TT
MZ602073	IK20	IK20TT
MZ602074	VW20T	IW20TT
MZ602075	VK20T	IK20TT
MZ602077	VK20	IK20TT
MZ602078	PQ16R	Q16TT
MZ602079	PQ20R	Q20TT
MZ602080	VXU22	-
MZ602081	IK22	-
MZ602082	VK16	IK16TT
MZ602083	SVK20RZ8	IK20TT
MZ602083	VK20Y	-
MZ602084	PKJ16CR-L11	IK16TT
MZ602085	IK20L	IK20TT
MZ602676	VK16	IK16TT
RAY66001	IW22	-
RAY66002	IW24	-

MV AGUSTA	DENSO	TT
80099561	IJ27A	-

NISMO	DENSO	TT
22401-RN0106	IK20	IK20TT
22401-RN0108	IK24	-
22401-RN02006	IKH20	IKH20TT
22401-RN02007	VKH22	-
22401-RN0206	IKH20	IKH20TT
22401-RN0207	IKH22	-
22401-RS1128	IK24	-
22401-RS1189	IK27	-
22401-RS2329	IQ27	-
22401-RS34508	IKH01-24	-
22401-RS34509	IKH01-27	-
22401-RS34510	IKH01-31	-
22401-RS3458	IKH01-24	-
22401-RS3459	IKH01-27	-

NISSAN	DENSO	TT
10065-10G00	DG-157	-
11065-00Q00	DG-005	-
11065-00Q0A	DG-126	-
11065-00Q0E	DG-609	-
11065-00QAA	DG-005	-
11065-00QAB	DG-126	-
11065-00QAE	DG-126	-
11065-00QAF	DG-005	-
11065-00QAG	DG-005	-
11065-10G00	DG-157	-
11065-29W00	DG-157	-
11065-2W202	DG-605	-
11065-2W204	DG-605	-
11065-2W211	DG-605	-
11065-31N00	DG-137	-
11065-37506	DG-157	-
11065-37507	DG-157	-
11065-43G01	DG-198	-
11065-4P400	DG-306	-
11065-57J00	DG-304	-
11065-5C900	DG-304	-

NISSAN	DENSO	TT
11065-63G00	DG-198	-
11065-6F900	DG-003	-
11065-7C000	DG-137	-
11065-9C600	DG-137	-
11065-AD200	DG-197	-
11065-AD201	DG-197	-
11065-AD210	DG-197	-
11065-AD220	DG-197	-
11065-BN701	DG-005	-
11065-C8600	DG-702	-
11065-D9702	DG-307	-
11065-G2400	DG-137	-
11065-G2460	DG-137	-
11065-G5501	DG-307	-
11065-T8200	DG-157	-
11065-T8202	DG-157	-
11065-V0700	DG-012	-
11065-V0710	DG-012	-
2240100QA	PK20PR-P8	IK20TT
22401-01B14	W14EXR-U11	IW16TT
22401-01M14	W14EXR-U11	IW16TT
22401-01P14	Q14R-U11	IQ16TT
22401-01P15	Q16PR-U11	Q16TT
22401-01P16	Q20PR-U11	Q20TT
22401-01P17	K22PR-U	-
2240102P15	Q16PR-U11	Q16TT
22401-02P16	Q20R-U	Q20TT
2240102P17	Q22PR-U11	-
22401-03300	W14PR-U	-
22401-08U15	PQ16R	Q16TT
22401-08U16	PQ20R	Q20TT
22401-08015	K16R-U	K16TT
22401-0P615	PQ16R	Q16TT
22401-0P616	PQ20R	Q20TT
2240110F14	Q14R-U11	IQ16TT
22401-10F15	Q16R-U	Q16TT
22401-10F16	Q20R-U	Q20TT
2240110F17	Q22PR-U	-
22401-10P15	Q16PR-U11	Q16TT
2240110P16	K20PR-U11	K20TT
2240110P17	Q22PR-U11	-
22401-11200	W20ESR-U	-
22401-12E15	Q16PR-U	Q16TT
22401-12E16	Q20PR-U	Q20TT
22401-12E23	K22PR-U	-
22401-18V16	P20PR11	W20TT
22401-19V15	Q16R-U	Q16TT
22401-19V16	Q20R-U	Q20TT
22401-19V66	Q20PR-U	Q20TT
22401-1F700	K20PR-U11	K20TT
22401-1F720	K16PR-U11	K16TT
22401-1HC1B	IKH16	IKH16TT
22401-1KT1B	FXE20HE11	IXEH20ETT
22401-1LA1C	VFXEH22	IXEH22TT
22401-1N516	K20PR-U	K20TT
22401-1P115	PK16PR-L11	IK16TT
22401-1P116	PK20PR11	K20TT
22401-1P117	PK22PR-L11S	-
22401-1P175	PK16PR-L11	IK16TT
22401-20J05	K16PR-U	K16TT
22401-20J06	K20PR-U	K20TT
22401-20J07	K16PR-U	K16TT
22401-21B15	W16EPR-U	W16TT
22401-21B16	W20EPR-U	W20TT
22401-2331R	FXE20HR11	IXEH20TT
22401-27N65	PK16PR-L11	IK16TT
22401-27N66	PK20PR11	K20TT
22401-27T65	P16PR11	W16TT
22401-2F200	PKJ20CR-L11	K20TT
22401-2J200	K16R-U11	K16TT
22401-2J204	IK16	IK16TT

NISSAN	DENSO	TT
22401-30R14	K16PR-U11	K16TT
22401-30R15	K16GPR-U11	-
22401-30R75	K16GPR-U11	-
22401-3682R	K20TXR	K20TT
22401-37P15	PK16R11	K16TT
22401-40P65	PK16R11	K16TT
22401-40V05	Q16PR-U11	Q16TT
22401-40V06	Q20PR-U	Q20TT
22401-40V07	Q22PR-U	-
22401-50V16	VW20T	IW20TT
22401-50Y04	K16PR-U11	K16TT
22401-50Y05	K16PR-U11	K16TT
22401-50Y06	K20PR-U11	K20TT
22401-53J04	K20R-U	K20TT
22401-53J05	K16R-U	K16TT
22401-53J06	K20R-U	K20TT
22401-53J07	K22PR-U	-
2240153J13	PK20PR-P8	IK20TT
22401-53J16	VK20	IK20TT
22401-53J66	PK20PR-P8	IK20TT
22401-53J67	PK22PR8	-
22401-53V16	PK20PR-P8	IK20TT
22401-53V17	PK22PR8	-
22401-55V16	PK20R8	IK20TT
22401-58S15	PQ16R	Q16TT
22401-58S16	PQ20R	Q20TT
22401-5M014	VKH16	IKH16TT
22401-5M015	VKH16	IKH16TT
22401-5M016	VKH16	IKH16TT
22401-70J10	IK20	IK20TT
22401-70J11	IK20	IK20TT
22401-70J13	IK16	IK16TT
22401-70J19	K20PR-U	K20TT
22401-74B00	K16PR-U11	K16TT
22401-74B11	K16PR-U11	K16TT
22401-75507	W20EPR-U	W20TT
22401-85E15	K16PR-U11	K16TT
22401-85E16	K20PR-U11	K20TT
22401-8651R	K20PR-U	K20TT
22401-8H 616	VKH20	IKH20TT
22401-8H314	IKH16	IKH16TT
22401-8H315	IKH16	IKH16TT
22401-8H316	IKH16	IKH16TT
22401-8H514	K20HR-U11	KH20TT
22401-8H515	K16HPR-U11	KH16TT
22401-8H516	K20HR-U11	KH20TT
22401-8P315	PK16R8	IK16TT
22401-97E65	PK16R11	K16TT
22401-99B07	K22PR-U11	-
22401-99B09	K20PR-U11	K20TT
22401-99B12	IK16	IK16TT
22401-99B17	K22PR-U11	-
22401-99B19	K20PR-U11	K20TT
22401-99B22	Q16PR-U11	Q16TT
22401-A4704	W14EPR-U	IW16TT
22401-A4705	W20EPR-U	W20TT
22401-A4706	W16EPR-U	W16TT
22401-AG215	PK16PR-L11	IK16TT
22401-AG315	VK16	IK16TT
22401-AH415	IK16	IK16TT
22401-AL515	IKH16	IKH16TT
22401-AR015	IKH16	IKH16TT
22401-AU015	K16HPR-U11	KH16TT
22401-AX015	K16HR-U11	KH16TT
22401-BC01B	K16HR-U11	KH16TT
22401-CK81B	FXE20HR11	IXEH20TT
22401-CP51B	FXE20HR11	IXEH20TT
22401-EA014	FXE20HR11	IXEH20TT
22401-EA016	VFXEH22	IXEH22TT
22401-ED715	FXE20HE11	IXEH20ETT
22401-ED71A	FXE16HE11	-

Spark & Glow Plugs

Cross Reference Chart - OE

NISSAN	DENSO	TT
22401-ED71B	FXE20HE11	IXEH20ETT
22401-ED815	FXE20HR11	IXEH20TT
22401-ED816	VFXEH22	IXEH22TT
22401-EN215	VFXEH20	IXEH20TT
22401-EN275	VFXEH20	IXEH20TT
22401-EW61C	VFXEH22	IXEH22TT
22401-F2000	W14EPR-U	IW16TT
22401-F6515	VQ16	IQ16TT
22401-F6516	PQ20R	Q20TT
22401-HC000	W16EXR-U13	W16TT
22401-JA01B	FXE20HR11	IXEH20TT
22401-JD01B	FXE20HR11	IXEH20TT
22401-JD07B	FXE20HR11	IXEH20TT
22401-JK01D	FXE24HR11	-
22401-M7714	W14E	-
22401-M7715	W16ESR-U	-
22401-M7716	W20ESR-U	-
22401-M7717	W22ESR-U	-
22401-M7915	W16ESR-U	-
22401-N8714	W14EXR-U11	IW16TT
22401-N8715	W16EPR-U11	W16TT
22401-N8716	W20EPR-U11	W20TT
22401-OP615	VQ16	IQ16TT
22401-OP616	VQ20	IQ20TT
22401-P8314	W14EXR-U11	IW16TT
22401-P8315	W16EXR-U11	W16TT
22401-P8316	W20EPR-U11	W20TT
22401-P8817	W22ESR-U	-
22401-Q9104	Q22PR-U11	-
22401-S2000	W16EPR-U	W16TT
22401-S2100	W20EPR-U	W20TT
22401-S6015	W16EXR-U13	W16TT
22401-S6500	W14EXR-U	IW16TT
22401-V0516	W20EPR-U	W20TT
22401-V1414	W14EXR-U	IW16TT
22401-V1415	W16EPR-U	W16TT
22401-V1416	W20EPR-U	W20TT
22401-V1491	W20EPR-U	W20TT
22401-V5015	Q16R-U11	Q16TT
22401-V5016	Q20P-U11	Q20TT
22401-V5017	Q22PR-U11	-
22401-VB000	W16EPR-U11	W16TT
22401-VR306	VW20T	IW20TT
22401-VS116	VK20T	IK20TT
22401-W8914	W14EPR-U	IW16TT
22401-W8915	W16EPR-U	W16TT
22401-W8916	W20EPR-U	W20TT
22401-W8917	W20EPR-U	W20TT
22401-WA066	PK20PR-P8	IK20TT
22401-W5517	IK22	-
22401-Y9015	K20PBR	K20TT
22401-Y9066	K20PBR	K20TT
22401-Y9067	K22PB	-
22401-ZE01B	VFKH16	IKH16TT
22401-ZJ51B	VFKH16	IKH16TT
997261	DG-202	-
B2401-4A00A	ZXU20PR11	-
B2401-4A00B	IXU22HPR	-
B2401-4A0A0	XU22EPR-U	XU22TT
B2401-4A0A2	IXU22	-
B2401-89904	W16EXR-U	W16TT
B2401-89905	W20EX-U	W20TT
B2401-95FOA	K16HPR-U11	KH16TT
B2401-95F0B	VKH16	IKH16TT
BY480-BKR5E	IK16	IK16TT
BY480-BKR6E	IK20	IK20TT
BY480-BPR5E	IW16	IW16TT
BY480-BPR6E	IW20	IW20TT
BY480-BPR7E	IW22	-
BY480-BPR8E	IW24	-
BY480-BPR9E	IW27	-

NISSAN	DENSO	TT
BY480-DCPR7E	IXU22	-
BY481-BCPR5	IQ16	IQ16TT
BY481-BCPR6	IQ20	IQ20TT
BY481-BKR5E	IK16	IK16TT
BY481-BKR6E	IK20	IK20TT
BY481-BKR7E	IK22	-
BY481-BPR5E	IW16	IW16TT
BY481-BPR6E	IW20	IW20TT
BY481-LFR5A	IKH16	IKH16TT
BY481-LFR6A	IKH20	IKH20TT
BY481-ZFR5F	IK16L	IK16TT
BY481-ZFR6F	KJ20SR11	IK20TT
BY482-BKR6E	VK20T	IK20TT
BY482-BPR6E	VW20T	IW20TT
BY483-BCPR5	PQ16R	Q16TT
BY483-BCPR6	PQ20R	Q20TT
BY483-BKR5E	VK16	IK16TT
BY483-BKR6E	VK20	IK20TT
BY483-LFR5A	VKH16	IKH16TT
BY483-LFR6A	VKH20	IKH20TT
BY483-ZFR5F	PKJ16CR-L11	IK16TT
BY483-ZFR6F	VK20	IK20TT
BY484-BKR5E	VK16	IK16TT
BY484-BKR6E	SVK20RZ8	IK20TT
BY484-BKR6E	VK20Y	-
BY484-BKR7E	VK22	-
BY484-DCPR7	VXU22	-
BY484-LFR6A	VKH20Y	-
BY484-LFR7A	VKH22	-

OPEL	DENSO	TT
12 14 112	KJ20CR-L11	K20TT
1214000	K20TXR	K20TT
1214002	W16EPR-U	W16TT
1214003	K20TNR	K20TT
1214004	K20R-U	K20TT
1214005	K20TXR	K20TT
1214007	W20EPR-U	W20TT
1214008	W20EPR-U11	W20TT
1214009	Q20PR-U	Q20TT
1214011	K20TXR	K20TT
1214012	PT16VR13	TV16TT
1214013	PT16VR13	TV16TT
1214015	K20TXR	K20TT
1214016	KJ20CR-L11	K20TT
1214018	DG-145	-
1214018	W20FSR-U	WF20TT
1214019	W20FPR-U	WF20TT
1214020	DG-005	-
1214026	PK20PR-P8	IK20TT
1214027	K20PBR	K20TT
1214028	DG-312	-
1214029	PK20PR-P8	IK20TT
1214030	PK20PR-L11	IK20TT
1214031	KJ16CR-L11	K16TT
1214032	DG-171	-
1214033	DG-142	-
1214034	DG-170	-
1214035	DG-302	-
1214036	DG-312	-
1214040	DG-122	-
1214041	KJ16CR-L11	K16TT
1214042	DG-104	-
1214043	DG-300	-
1214045	DG-133	-
1214046	PK20PR-P8	IK20TT
1214056	DG-142	-
1214060	PK20PR-L11	IK20TT
1214062	DG-302	-
1214063	DG-302	-
1214064	DG-196	-

OPEL	DENSO	TT
1214070	DG-171	-
1214071	DG-170	-
1214073	DG-122	-
1214079	DG-312	-
1214091	XU22EPR-U	XU22TT
1214134	W20FPR-U	WF20TT
1214138	W20FPR-U	WF20TT
1214139	W20EPR-U	W20TT
1214141	K20TXR	K20TT
1214144	K20PR-U	K20TT
1214148	Q20PR-U	Q20TT
1214149	W16EPR-U	W16TT
1214301	DG-302	-
1214304	DG-001	-
1214305	DG-142	-
1214306	DG-001	-
1214307	DG-001	-
1214308	DG-143	-
1214309	DG-159	-
1214310	DG-104	-
1214311	DG-124	-
1214312	DG-124	-
1214315	DG-104	-
1214316	DG-300	-
1214317	DG-001	-
1214319	DG-001	-
1214320	DG-104	-
1214321	DG-108	-
1214322	DG-133	-
1214323	DG-108	-
1214324	DG-001	-
1214334	DG-608	-
1214427	DG-109	-
1214455	K20TXR	K20TT
1214456	DG-118	-
1214457	DG-118	-
1214458	K16PR-U11	K16TT
1214459	DG-186	-
1214462	PK16PR-L11	IK16TT
1214527	IKH20	IKH20TT
1214528	IK20L	IK20TT
1214700	W20FPR-U	WF20TT
1214801	W20FPR-U	WF20TT
1214802	W20EPR-U	W20TT
1214803	W20EPR-U11	W20TT
1214805	W20FPR-U	WF20TT
1214807	W20EPR-U	W20TT
1826357	DG-621	-
25173847	ITV20	ITV20TT
25193473	KJ20CR-L11	K20TT
4300010	W20EPR-U	W20TT
4300425	DG-108	-
4317021	W20EPR-U	W20TT
4402724	DG-005	-
4402945	DG-008	-
4403145	DG-004	-
4410220	PK20PR-P8	IK20TT
4413288	PK20PR-P8	IK20TT
4415128	DG-605	-
4416912	DG-005	-
4430069	DG-126	-
4430920	DG-126	-
4432200	PK20PR-P8	IK20TT
4506155	DG-126	-
4708892	ZXU20PR11	-
4802903	ITL16	ITL16TT
4805484	PT16VR13	TV16TT
4805511	DG-604	-
4810709	ITV16	ITV16TT
4811581	ITV16	ITV16TT
5614216	DG-012	-

OPEL	DENSO	TT
5614218	DG-001	-
5614219	DG-012	-
5614221	DG-143	-
88900715	DG-117	-
88900716	DG-109	-
88900717	DG-144	-
88900718	DG-155	-
88900719	DG-184	-
88900720	DG-007	-
88900722	DG-005	-
88900723	DG-012	-
88900724	DG-119	-
88900725	DG-001	-
88900726	DG-003	-
88900727	DG-106	-
88900728	DG-001	-
88900729	DG-102	-
88900731	DG-001	-
88900732	DG-123	-
88900733	DG-001	-
88900734	DG-001	-
88900736	DG-001	-
88900737	DG-004	-
88900738	DG-001	-
88900739	DG-143	-
88900740	DG-006	-
88900743	DG-124	-
90040991	DG-123	-
90051950	DG-001	-
90093867	DG-001	-
90093897	DG-001	-
90166155	DG-001	-
90210824	DG-001	-
90487858	DG-001	-
90540864	DG-001	-
90569338	DG-118	-
91153919	DG-109	-
94439218	DG-143	-
97127646	DG-312	-

PIAGGIO	DENSO	TT
641387	Y27FER-C	-
P2M	W27ESR-U	-
P4M	W22ESR-U	-
P82M	IWF22	-
P86M	W16FSR	-

POLARIS	DENSO	TT
3070189	IT22	-

PORSCHE	DENSO	TT
92809460203	W20EPR-U	W20TT
955 170 220 90	VXUHC22G	-
95517032090	DG-193	-
999 170 220 90	VXUHC22G	-
99902080210	W20FSR-U	WF20TT
99917000290	W22FPR-U	-
99917000890	IW24	-
99917000891	IW24	-
99917001090	IW24	-
99917001091	IW24	-
99917002291	IW24	-
99917005090	W22EPR-U	W22TT
99917005190	W22EPR-U	W22TT
99917005290	W22EPR-U	W22TT
99917005590	W22EPR-U	W22TT
99917005690	W22EPR-U	W22TT
99917010390	PK20R11	K20TT
99917010790	W24EPR-U	-
99917011090	IW24	-
99917011190	W22EPR-U	W22TT

Spark & Glow Plugs

Cross Reference Chart - OE

PORSCHE	DENSO	TT
99917011990	W20EPR-U	W20TT
99917012690	W20EPR-U	W20TT
99917012890	IW24	-
99917012990	XU22EPR-U	XU22TT
99917013290	W16EPR-U	W16TT
99917013390	W16EPR-U	W16TT
99917013590	W22EPR-U	W22TT
99917013690	W16EPR-U	W16TT
99917013890	W20EPR-U	W20TT
99917013990	W20EPR-U	W20TT
99917014190	W20FPR-U	WF20TT
99917014290	W20FPR-U	WF20TT
99917014690	W20EPR-U	W20TT
99917014890	W20EPR-U	W20TT
99917016590	W22EPR-U	W22TT
99917016790	W20FPR-U	WF20TT
99917016890	W20EPR-U	W20TT
99917017090	W16EPR-U	W16TT
99917017690	X24ESR-U	-
99917018290	K22PBR-S	-
99917018390	K22PBR-S	-
99917018690	IW24	-
99917019590	K22TNR-S	-
99917020190	K20TNR	K20TT
99917020490	K20PBR-S10	K20TT
99917020491	K20PBR-S10	K20TT
99917020791	K20PBR-S10	K20TT
99917021890	K20PBR-S10	K20TT
99917021990	K20PBR-S10	K20TT
99917022190	VK22	-
99917022300	K22PBR-S	-
99917022390	IK22	-
99917022790	IK24	-
99917022890	VKH20	IKH20TT
99917022990	IKH22	-
N1781119	W20ESR-U	-
N1781113	W22EPR-U	W22TT
N1781118	W20EPR-U	W20TT
N1781216	W20ESR-U	-
N178128	W20EPR-U	W20TT
N1781399	W20EPR-U	W20TT

POWER LAWN PARTS	DENSO	TT
PLP14JC	W14MR-U	-
PLP6JD	T22M-U	-
PLP7JD	T20M-U	-
PLP8J	W14-US	-
PLP8JC	W20M-US	-
PLP8JD	T20M-U	-
PLPML19J	W14LM-US	-

PROTON	DENSO	TT
LAP6FS	MA20P-U	-
LAPR6FS	MA20PR-U	-
LBCP6ES	Q20PR-U	Q20TT
LBCPR6ES	Q20PR-U	Q20TT
LBP5ES	W16EPR-U	W16TT
LBP6EFS	T20EPR-U	T20TT
LBP6ES	W20EPR-U	W20TT
LBP6EFS	T20EPR-U	T20TT
MS851232E	W16EPR-U	W16TT
MS851233E	W20EPR-U	W20TT
MS851358E	K20PR-U11	K20TT

RENAULT	DENSO	TT
224018760R	XE20HR-U9	IXEH20TT
5001001587	DG-001	-
6001004972	IT27	-
6001040356	K20PBR-S10	K20TT
6001040357	K20PBR-S10	K20TT
6001040543	T16EPR-U	T16TT

RENAULT	DENSO	TT
7439146775	K20PBR-S10	K20TT
7700100558	DG-008	-
7700100586	DG-101	-
7700100635	DG-112	-
7700101401	Q16PR-U	Q16TT
7700103502	W16EPR-U	W16TT
7700103503	W16EPR-U	W16TT
7700103533	K20TXR	K20TT
7700103674	DG-126	-
7700105290	DG-009	-
7700107916	K20TXR	K20TT
7700111323	DG-005	-
7700111940	DG-112	-
7700115827	K20TXR	K20TT
7700260637	K20TXR	K20TT
7700267140	T20EPR-U	T20TT
7700267805	IT22	-
7700273462	K20PR-U	K20TT
7700273698	PK20PR-P8	IK20TT
7700274004	K20PR-U	K20TT
7700274154	K20PR-U	K20TT
7700274155	K20PR-U	K20TT
7700500000	W20EPR-U	W20TT
7700500012	W16EPR-U	W16TT
7700500024	W24EPR-U	-
7700500036	IW24	-
7700500048	W16EPR-U	W16TT
7700500072	T20EPR-U	T20TT
7700500084	T20EPR-U	T20TT
7700500096	K20TXR	K20TT
7700500108	T22EPR-U	-
7700500120	IW22	-
7700500132	K20PBR	K20TT
7700500144	K20PBR	K20TT
7700500155	K20PR-U	K20TT
7700500168	K20TXR	K20TT
7700500180	K20PR-U	K20TT
7700500192	K16HPR-U11	KH16TT
7700500204	T16EPR-U	T16TT
7700500216	IK22	-
7700500228	IT27	-
7700500240	PK20PR-L11	IK20TT
7700529980	W20FPR-U	WF20TT
7700558395	W16FPR-U	-
7700565155	IW27	-
7700587168	W20FPR-U	WF20TT
7700692428	W16EPR-U	W16TT
7700701130	DG-001	-
7700704185	DG-001	-
7700714540	IK20	IK20TT
7700715768	DG-001	-
7700722095	T20EPR-U	T20TT
7700722395	T20EPR-U	T20TT
7700724821	W16EPR-U	W16TT
7700725302	W16EPR-U	W16TT
7700726503	T22EPR-U	-
7700727383	IT20	IT20TT
7700731583	T22EP-U	-
7700732626	W24EPR-U	-
7700733076	DG-001	-
7700733422	W20EPR-U	W20TT
7700734956	DG-006	-
7700735455	IW22	-
7700736149	T22EP-U	-
7700736150	T22EP-U	-
7700737457	W20EPR-U	W20TT
7700737458	T20EPR-U	T20TT
7700737459	W24EPR-U	-
7700737612	Q16R-U	Q16TT
7700741144	DG-001	-
7700742094	W22EPR-U	W22TT

RENAULT	DENSO	TT
7700743137	Q16R-U	Q16TT
7700749163	Q16R-U	Q16TT
7700824821	W16EPR-U	W16TT
7700852543	IT22	-
7700854538	DG-012	-
7700855463	K20PBR	K20TT
7700855865	DG-001	-
7700855918	IT20	IT20TT
7700856238	DG-001	-
7700856292	DG-012	-
7700856342	K20PBR	K20TT
7700856908	Q16R-U	Q16TT
7700856909	Q16PR-U	Q16TT
7700856910	Q20PR-U	Q20TT
7700858208	DG-101	-
7700858444	K20PBR-S10	K20TT
7700859910	Q16R-U	Q16TT
7700859967	W16EXR-U	W16TT
7700860235	W16EXR-U	W16TT
7700860796	DG-101	-
7700861471	W24EPR-U	-
7700861906	DG-101	-
7700862054	IW22	-
7700867002	DG-009	-
7700867617	DG-012	-
7700868864	W16EPR-U	W16TT
7700869200	K16PR-U	K16TT
7700871617	K20PBR	K20TT
7700874336	DG-009	-
7701021767	T20EPR-U	T20TT
7701023080	W20EPR-U	W20TT
7701029762	DG-001	-
7701032921	T22EP-U	-
7701033403	DG-001	-
7701035956	DG-001	-
7701039387	DG-001	-
7701040208	DG-004	-
7701041214	W16EPR-U	W16TT
7701041215	T20EPR-U	T20TT
7701043624	K20PBR	K20TT
7701052949	DG-312	-
7701053104	VKH16	IKH16TT
7701057806	DG-312	-
7701058142	DG-605	-
7701065085	FXE20HR11	IXEH20TT
7701069731	DG-001	-
7701349475	DG-001	-
7701349943	DG-001	-
7701349949	DG-012	-
7701366084	IW24	-
7701366085	IW24	-
7701366086	W20EPR-U	W20TT
7701366087	W24EPR-U	-
7701366137	T20EPR-U	T20TT
7701366138	W20EPR-U	W20TT
7701366267	W20EPR-U	W20TT
7701366268	W22EPR-U	W22TT
7701366269	W16EPR-U	W16TT
7701366270	T20EPR-U	T20TT
7701366513	IW22	-
7701366514	T20EPR-U	T20TT
7701366515	W16FPR-U	-
7701366516	IWF20	-
7701366533	IW20	IW20TT
7701366539	W16EPR-U	W16TT
7701366903	IWF16	-
7701414021	W16EPR-U	W16TT
7701414022	IWF20	-
7701414023	W16FPR-U	-
7701414024	IW20	IW20TT
7701414025	IW22	-

RENAULT	DENSO	TT
7701414026	IW20	IW20TT
7701414027	IT22	-
7701414028	IT22	-
7701414029	T22EP-U	-
7701414030	IT20	IT20TT
7701414031	IT20	IT20TT
7701414032	W16EPR-U	W16TT
7701414036	W16EPR-U	W16TT
7701414037	IWF22	-
7701414038	IWF22	-
7701414039	IT20	IT20TT
7701414040	IK20	IK20TT
7701414056	IK22	-
7701414065	IT20	IT20TT
7701414066	IK22	-
7701414072	DG-001	-
7701414076	DG-001	-
7701414077	DG-012	-
7701414078	DG-123	-
7701414080	DG-001	-
7701414081	DG-004	-
7701414084	DG-202	-
7701414086	DG-001	-
7701414088	DG-012	-
7701414107	DG-010	-
7701414108	DG-001	-
7701414123	DG-001	-
7701414157	DG-010	-
7701742094	IT27	-
8200012099	DG-126	-
8200020791	K20PR-U	K20TT
8200020796	K20PR-U	K20TT
8200021856	K20PR-U	K20TT
8200030765	XE20HR-U9	IXEH20TT
8200033622	K20PR-U	K20TT
8200034236	K16HPR-U11	KH16TT
8200046337	PK20PR-P8	IK20TT
8200090817	DG-001	-
8200120796	IKH20	IKH20TT
8200239321	PK20PR-L11	IK20TT
8200314928	VK22	-
8200322273	XE20HR-U9	IXEH20TT
8200332273	XE20HR-U9	IXEH20TT
8200363384	PK20PR-P8	IK20TT
8200421091	DG-005	-
8200423227	DG-112	-
8200434855	DG-005	-
8200445627	DG-126	-
8200464077	DG-005	-
8200490950	DG-005	-
8200492426	VK22	-
8200592215	XE20HR-U9	IXEH20TT
8200656784	K20PR-U	K20TT
8200662185	XE20HR-U9	IXEH20TT
8200682592	DG-609	-
8200787721	DG-112	-
8200794920	DG-619	-
8304504277	KJ16CR-L11	K16TT
8671004086	K20PR-U	K20TT
8933003862	K20PR-U	K20TT
9632182880	PK20PR11	K20TT
9636415880	IKH16	IKH16TT
UE0073007	IK20	IK20TT

ROLLS-ROYCE	DENSO	TT
12120037608	K20TXR	K20TT
12120148591	K20TXR	K20TT
RH12050	IW16	IW16TT
RH13439	IK16	IK16TT
RH13998	IK16	IK16TT
UEM78911	IK22	-

SUBARU	DENSO	TT
SAB330DE5210	ITV20	ITV20TT
SAB330DE5260	VKH20Y	-
SAB330DE5270	VKH22	-
SAB330DE8430	IK22	-
SAB330DE8640	SK16PR-A11	IK16TT
SAB330DE8680	IK16	IK16TT
SAB330DE8690	IK20	IK20TT
SAB330DE8720	IXU22	-
SAB330DE8730	IXU24	-
SAB330DE8740	IXUH22	-
SAB330DE8750	VXUH22	-
SAB330DE8760	IXUH22I	-
SAB330DE8770	VXUH22I	-
SAB330NG0508	IK16	IK16TT
SAB330NG0511	IK16	IK16TT
SAB330NG0608	IK20	IK20TT
SAB330NG0611	IK20	IK20TT
SAB330NG1708	IXU22	-
SAB330NG4611	IKH20	IKH20TT
SAB330NG7611	VKH20	IKH20TT
SAB330NG8508	VK16	IK16TT
SAB330NG8511	VK16	IK16TT
SAB330NG8608	SVK20RZ8	IK20TT
SAB330NG8608	VK20Y	-
SAB330NG8611	VK20	IK20TT
SAB330NG8708	VK22	-
SAB330NG9708	VXU22	-
SAB33NG5708	IK22	-
SAB33NG6808	IXU24	-
SOA528000	W20EPR-U11	W20TT

SUZUKI	DENSO	TT
09482-00004	IQ16	IQ16TT
09482-00036	W14FPR-U	-
09482-00041	W14FPR-U	-
09482-00054	W20ESR-U	-
09482-00057	W24FSR	-
09482-00058	W20FSR-U	WF20TT
09482-00061	IWF24	-
09482-00062	W20FPR-U	WF20TT
09482-00066	W27ESR-U	-
09482-00068	IW01-24	-
09482-00071	W20ESR-U	-
09482-00082	W22FS-U	-
09482-00083	IWF22	-
09482-00084	W20FPR-U	WF20TT
09482-00085	W22FS-U	-
09482-00089	W22ESR-U	-
09482-00090	W20FPR-U	WF20TT
09482-00091	W24ESR-U	-
09482-00092	W22ESR-U	-
09482-00094	W24ESR-U	-
09482-00095	W20FSR-U	WF20TT
09482-00105	W22FPR-U	-
09482-00106	IW01-24	-
09482-00118	W20EPR-U	W20TT
09482-00119-7	W27ESR-U	-
09482-00120	W16FPR-U	-
09482-00121	W24ESR-U	-
09482-00123	W16EXR-U	W16TT
09482-00124	W16FPR-U	-
09482-00128	W20ESR-U	-
09482-00129	W14EX-U	IW16TT
09482-00130	W14EX-U	IW16TT
09482-00131	W16EPR-U	W16TT
09482-00132	W22FPR-U	-
09482-00136	W14FPR-UL	-
09482-00138	W16EPR-U	W16TT
09482-00139	W22EPR-U	W22TT
09482-00140	W14FPR-U	-
09482-00141	W20FPR-U	WF20TT

SUZUKI	DENSO	TT
09482-00142	W14F-U	-
09482-00144	X24ESR-U	-
09482-00145	X24ESR-U	-
09482-00147	W16FPR-U	-
09482-00149	X24ESR-U	-
09482-00154	W22EPR-U	W22TT
09482-00155	W16EPR-U	W16TT
09482-00159	W14EXR-U	IW16TT
09482-00160	W20EPR-U	W20TT
09482-00162	IW27	-
09482-00163	W16FPR-U	-
09482-00167	W16EXR-U	W16TT
09482-00170	W14FPR-UL	-
09482-00171	W14FPR-UL	-
09482-00173	W14FPR-UL	-
09482-00175	W24EPR-U	-
09482-00176	W9FP-UL	-
09482-00178	W24EPR-U	-
09482-00180	IW31	-
09482-00182	X22ESR-U	-
09482-00183	X22ESR-U	-
09482-00184	X27ESR-U	-
09482-00185	X27ESR-U	-
09482-00186	W14FPR-U	-
09482-00187	IWF24	-
09482-00188	W20FPR-U	WF20TT
09482-00189	W22FPR-U	-
09482-00190	W20FSR-U	WF20TT
09482-00191	W22FS-U	-
09482-00192	W24FSR	-
09482-00193	W20EP-U	W20TT
09482-00194	W16FPR-U	-
09482-00195	W22ESR-U	-
09482-00196	W24ESR-U	-
09482-00197	W22EPR-U	W22TT
09482-00205	W14FPR-UL	-
09482-00206	W14FPR-UL	-
09482-00208	IW24	-
09482-00209	IW27	-
09482-00210	IW31	-
09482-00216	W14EXR-U11	IW16TT
09482-00217	W16EXR-U11	W16TT
09482-00218	W14EXR-U11	IW16TT
09482-00222	X22ESR-U	-
09482-00223	X24ESR-U	-
09482-00224	X27ESR-U	-
09482-00231	W27ESR-U	-
09482-00233	W27ESR-U	-
09482-00233-111	W27ESR-U	-
09482-00239	W24EPR-U	-
09482-00240	W24EPR-U	-
09482-00240-111	W24EPR-U	-
09482-00241	IW27	-
09482-00241-111	IW27	-
09482-00242	W24FSR	-
09482-00242-111	W24FSR	-
09482-00243	W14FPR-U	-
09482-00243-111	W14FPR-U	-
09482-00244	W22FPR-U	-
09482-00244-111	W22FPR-U	-
09482-00245	W20FPR-U	WF20TT
09482-00245-111	W20FPR-U	WF20TT
09482-00247	W24ESR	-
09482-00247-111	W24ESR	-
09482-00255	W22FPR-U	-
09482-00258	W20MPR-U10	-
09482-00261	W14MPR-U10	-
09482-00262	W16FPR-U	-
09482-00263	W16FPR-U	-
09482-00264	W20FPR-U10	WF20TT
09482-00265	W20FPR-U10	WF20TT

SUZUKI	DENSO	TT
09482-00269	W22FS-U	-
09482-00273	W22ESR-U	-
09482-00273-111	W22ESR-U	-
09482-00274	W24FP-U	-
09482-00274-111	W24FP-U	-
09482-00278	W24FSR-U10	-
09482-00280	W24FSR-U10	-
09482-00284	W20EXR-U11	W20TT
09482-00285	W20EPR-U11	W20TT
09482-00286	W20EXR-U11	W20TT
09482-00287	W16EPR-U11	W16TT
09482-00294	U20FSR-U	-
09482-00295	W24FP-U	-
09482-00298	W16FPR-U	-
09482-00298-111	W16FPR-U	-
09482-00299	W20EPR-U	W20TT
09482-00300	W20EXR-U	W20TT
09482-00302	W20FPR-U	WF20TT
09482-00302-111	W20FPR-U	WF20TT
09482-00303	W20EX-U	W20TT
09482-00312	W16EXR-U11	W16TT
09482-00314	U22FSR-U	-
09482-00316	W16FPR-U	-
09482-00317	U24FSR-U	-
09482-00318	W20EXR-U	W20TT
09482-00318-111	W20EXR-U	W20TT
09482-00320	U24FSR-U	-
09482-00320-111	U24FSR-U	-
09482-00322	IW16	IW16TT
09482-00329	U24FSR-U	-
09482-00329-111	U24FSR-U	-
09482-00330	X27EPR-U9	-
09482-00331	X27EPR-U9	-
09482-00331-111	X27EPR-U9	-
09482-00332	X24EPR-U9	-
09482-00333	X24EPR-U9	-
09482-00333-111	X24EPR-U9	-
09482-00334	X24EPR-U9	-
09482-00335	X24EPR-U9	-
09482-00335-111	X24EPR-U9	-
09482-00338	W20FSR-U	WF20TT
09482-00340	U20FSR-U	-
09482-00349	W27ESR-U	-
09482-00353	X27EPR-U9	-
09482-00353-111	X27EPR-U9	-
09482-00354	X22EPR-U9	-
09482-00355	X22EPR-U9	-
09482-00355-111	X22EPR-U9	-
09482-00359	W16FPR-U	-
09482-00361	X22EPR-U9	-
09482-00362	J16CR-U	W16TT
09482-00373	U24FSR-U	-
09482-00374	U24FSR-U	-
09482-00374-111	U24FSR-U	-
09482-00375	W24FSR-U10	-
09482-00378	XU24EPR-U	-
09482-00379	XU24EPR-U	-
09482-00383	U24FSR-U	-
09482-00384	IXU24	-
09482-00385	W22EPR-U	W22TT
09482-00386	IXU22	-
09482-00387	IXU24	-
09482-00392	W20EP-U	W20TT
09482-00393	XU20EPR-U	-
09482-00395	J16CR-U	W16TT
09482-00396	IXU22	-
09482-00396-111	IXU22	-
09482-00397	X27ETR	-
09482-00399	X24ESR-U	-
09482-00400	X27ESR-U	-
09482-00404	U24FSR-U	-

SUZUKI	DENSO	TT
09482-00405	IW27	-
09482-00406	U20FSR-U	-
09482-00407	U20FSR-U	-
09482-00409	W20EXR-U	W20TT
09482-00410	U27ETR	-
09482-00411	U27ETR	-
09482-00412	U24ETR	-
09482-00413	U24ETR	-
09482-00415	U22ETR	-
09482-00416	W16FPR-U	-
09482-00416-111	W16FPR-U	-
09482-00420	W14FPR-U	-
09482-00420-111	W14FPR-U	-
09482-00421	W20EPR-U11	W20TT
09482-00422	IWM01-29	-
09482-00426	K20P-U	K20TT
09482-00427	K20PR-U	K20TT
09482-00428	K20P-U	K20TT
09482-00429	K20PR-U	K20TT
09482-00432	W16EPR-U	W16TT
09482-00433	W16EXR-U11	W16TT
09482-00434	W22EPR-U	W22TT
09482-00446	XU20EPR-U	-
09482-00447	XU20EPR-U	-
09482-00448	XU22EPR-U	XU22TT
09482-00449	XU22EPR-U	XU22TT
09482-00450	XU24EPR-U	-
09482-00451	K20P-U	K20TT
09482-00453	XU24EPR-U	-
09482-00454	J16CR-U	W16TT
09482-00455	J16CR-U	W16TT
09482-00456	U24ESR-N	-
09482-00457	U24ESR-N	-
09482-00458	U27ESR-N	-
09482-00459	U27ESR-N	-
09482-00461	U31ESR-N	-
09482-00462	U31ETR	-
09482-00463	U31ETR	-
09482-00468	W16EPR-U	W16TT
09482-00471	J16CR-U	W16TT
09482-00472	W27EMR-C	-
09482-00473	W27EMR-C	-
09482-00475	W24EMR-C	-
09482-00476	K16PR-U	K16TT
09482-00477	K16PR-U	K16TT
09482-00478	W31ESR-U	-
09482-00479	IXU22	-
09482-00481	IXU24	-
09482-00482	IWM31	-
09482-00484	IXU22	-
09482-00487	W20EPR-U	W20TT
09482-00493	W16EPR-U11	W16TT
09482-00494	K20PR-U11	K20TT
09482-00495	W22EPR-U	W22TT
09482-00496	W16EPR-U11	W16TT
09482-00497	K16PR-U11	K16TT
09482-00498	W22EPR-U	W22TT
09482-00499	IW24	-
09482-00500	IW27	-
09482-00503	IXU24	-
09482-00504	W16EXR-U	W16TT
09482-00505	K20PR-U	K20TT
09482-00506	W16EPR-U	W16TT
09482-00508	K20PR-U11	K20TT
09482-00509	IW01-24	-
09482-00510	K20PR-U11	K20TT
09482-00512	W22ESR-U	-
09482-00515	U22ESR-N	-
09482-00516	U22ESR-N	-
09482-00520	IXU22	-
09482-00521	P16PR11	W16TT

Spark & Glow Plugs

Cross Reference Chart - OE

SUZUKI	DENSO	TT
09482-00522	W22FPR-U	-
09482-00525	VXU22	-
09482-00527	IXU22	-
09482-00529	U20ESR-N	-
09482-00530	W20FPR-U	WF20TT
09482-00532	W22FS-U	-
09482-00534	W20FSR-U	WF20TT
09482-00537	IXU27	-
09482-00546	IW16	IW16TT
09482-00547	SK16PR-A11	IK16TT
09482-00548	SK20PR-A11	IK20TT
09482-00549	SK16PR-A11	IK16TT
09482-00550	VK20	IK20TT
09482-00554	IU22	-
09482-00555	IU24D	-
09482-00557	IU27D	-
09482-00559	IU31	-
09482-00562	SK16PR-A11	IK16TT
09482-00563	IXU22	-
09482-00584	IU24	-
09482-00600	IU24	-
09482-00602	ZXU20PR11	-
09482-00603	ZXU20PR11	-
09482-00605	K16HPR-U11	KH16TT
09482-00606	VKH20	IKH20TT
09482-00607	IXU22HPR	-
09482-00608	IXU22HPR	-
09482-00610	VXU22	-
09482-00618	ZXU20PR11	-
09482-00649	XU20HR9	-
09482-79856	P16PR11	W16TT
09482-A00155	W20EPR-U	W20TT
09482-M00611	ZXU20PR11	-
09482-M40132	W16EPR-U	W16TT
1119284E00	KJ16CR-L11	K16TT
11192-84E00	KJ16CR-L11	K16TT
1119A-78J00	PT16VR13	TV16TT
13170-79J81	DG-608	-
15320-86CA0	DG-001	-
18550-50KA0	DG-619	-
18550-66G00	DG-001	-
18550-67G00	DG-116	-
18550-67G10	DG-116	-
18550-67G11	DG-116	-
18550-73J00	DG-113	-
18550-78E00	DG-146	-
18550-79J50	DG-196	-
18550-79J80	DG-608	-
18550-79J81	DG-608	-
18550-80KA0	DG-619	-
18550-80KA0-000	DG-619	-
18550-84A00	DG-005	-
18550-84A50	DG-005	-
18550-84A51	DG-005	-
18550-84E50	DG-171	-
18550-M86J00	DG-171	-
271175	IK22	-
271180	IXU24	-
271185	IK24	-
271190	IXU27	-
4DA36-M07	IK22	-
4DA36-M08	IK24	-
4DA36-M09	IK27	-
4DA36-M10	IK31	-
4GA36-M08	IXU24	-
4GA36-M09	IXU27	-
9048200448	IXU22	-
99000-69835-B6R	IWF22	-
99000-69835-B7R	IWF22	-
99000-69835-B8R	IWF24	-
99000-69835-BP6	IWF20	-

SUZUKI	DENSO	TT
99000-69835-BP7	IWF22	-
99000-69835-BR1	IW31	-
99000-69835-BR8	IW24	-
99000-69835-BR9	IW27	-
99000-69835-C6R	IUF22	-
99000-69835-C7R	IUF22	-
99000-69835-C8R	IUF24	-
99000-69835-CR7	IU22	-
99000-69835-CR8	IU24	-
99000-69835-CR9	IU27	-
99000-69835-DC8	IXU24	-
99000-69835-DR8	IX24	-
99000-69835-DR9	IX27	-
99000-69835-PR7	IX22B	-
99000-69835-PR8	IX24B	-
99000-69835-PR9	IX27B	-
99000-79372	W14EXR-U11	IW16TT
99000-79374	IW24	-
99000-79384	W20EX-U	W20TT
99000-79385	W14FPR-U	-
99000-79387	W16FPR-U	-
99000-79388	W16ESR-U	-
99000-79389	W22ESR-U	-
99000-79682	W20FSR-U	WF20TT
99000-79683	W20FSR-U	WF20TT
99000-79684	W22FS-U	-
99000-79A37-16E	IW16	IW16TT
99000-79A37-20F	IWF20	-
99000-79A37-22E	IW24	-
99000-79A37-22F	IWF22	-
99000-79A37-24E	IW24	-
99000-79A37-24F	IWF24	-
99000-79A37-24R	IW24	-
99000-79A37-27E	IW27	-
99000-79A37-27R	IW27	-
99000-79A37-29E	IW29	-
99000-79A37-31E	IW31	-
99000-79A37-K0P	IK20	IK20TT
99000-79A37-K6P	IK16	IK16TT
99000-79A37-U2F	IUF22	-
99000-79A37-U4E	IU24	-
99000-79A37-U4F	IUF24	-
99000-79A37-U4R	IUF24	-
99000-79A37-U7E	IU27	-
99000-79A37-U7F	IUF27A	-
99000-79A37-W0P	IW20	IW20TT
99000-79A37-W1M	IWM31	-
99000-79A37-W2P	IW22	-
99000-79A37-W4X	IW16	IW16TT
99000-79A37-W6X	IW16	IW16TT
99000-79A37-W7M	IWM27	-
99000-79A37-X2E	IX22	-
99000-79A37-X4E	IX24	-
99000-79A37-X4P	IX24B	-
99000-79A37-X7E	IX27	-
99000-79A37-X7P	IX27B	-
99000-79A37-XU2	IXU22	-
99000-79A37-XU4	IXU24	-
99000-79B56	W14EXR-U11	IW16TT
99000-79J80-K16	IK16	IK16TT
99000-79J80-K20	IK20	IK20TT
99000-79J80-U22	IXU22	-
99000-79J80-U24	IXU24	-
99000-79J80-UH2	IXUH22	-
99000-79J80-W16	IW16	IW16TT
99000-79J80-W20	IW20	IW20TT
99000-79J80-W22	IW22	-
99000-79K24-22B	IX22B	-
99000-79K24-24A	IU24A	-
99000-79K24-24B	IX24B	-
99000-79K24-27A	IU27A	-

SUZUKI	DENSO	TT
99000-79K24-27B	IX27B	-
99000-79K24-31A	IU31A	-
99000-79K24-F22	IUF22	-
99000-79K24-F24	IUF24	-
99000-79K24-H24	IUH24	-
99000-79K24-H27	IUH27	-
99000-79K24-IW4	IW24	-
99000-79K24-IW7	IW27	-
99000-79K24-U22	IU22	-
99000-79K24-U24	IU24	-
99000-79K24-U27	IU27	-
99000-79K24-U31	IU31	-
99000-79K24-W22	IWF22	-
99000-79K24-W24	IWF24	-
99000-79K24-W27	IWF27	-
99000-79K24-W31	IW31	-
99000-79K24-X22	IX22	-
99000-79K24-X24	IX24	-
99000-79K24-X27	IX27	-
99000-79K60-BP6	IW20	IW20TT
99000-79K60-DC7	IXU22	-
99000-79K60-K5R	IK16	IK16TT
99000-79K60-K6R	IK20	IK20TT
99000-79K60-KR6	IK20	IK20TT
99000-79K60-P5R	IW16	IW16TT
99000-79K60-P6R	IW20	IW20TT
99000-79K60-P7R	IW22	-
99000-79K60-PR5	IW16	IW16TT
99000-79K73-K16	VK16	IK16TT
99000-79K73-K20	VK20	IK20TT
99000-79K73-U22	VXU22	-
99000-79K73-U24	VXU24	-
99000-79K73-UH2	VXUH22	-
99000-79K73-W16	VW16	IW16TT
99000-79K73-W20	VW20	IW20TT
99000-79K73-W22	VW22	-
99000-79L65	VK20Y	-
99000-79L65-001	VK20	IK20TT
99000-79L65-002	VK16	IK16TT
99000-79L65-003	SVK20RZ8	IK20TT
99000-79L65-003	VK20Y	-
99000-79L65-004	VXU22	-
99000-79L65-005	VK16	IK16TT
99000-79L65-006	VK22	-
99000-79L65-008	VW16	IW16TT
99000-79L65-009	VW20	IW20TT
99000-79L65-010	VW20	IW20TT
99000-79X12-K16	K16TT	K16TT
99000-79X12-K20	K20TT	K20TT
99000-79X12-W16	W16TT	W16TT
99000-79X12-XU2	XU22TT	XU22TT
99000-79X12-XUH	XUH22TT	XUH22TT

TACTI	DENSO	TT
067600-1810	IW06-27	-
067600-1820	IW06-31	-
067600-1830	IW06-34	-
267700-1010	IU01-24	-
267700-1020	IU01-27	-
267700-1030	IU01-31	-
267700-1040	IU01-34	-
267700-1060	IXU01-24	-
267700-1070	IXU01-27	-
267700-1080	IXU01-31	-
267700-1090	IXU01-34	-
267700-1110	IW01-24	-
267700-1120	IW01-27	-
267700-1130	IW01-29	-
267700-1140	IW01-31	-
267700-1150	IW01-32	-
267700-1160	IW01-34	-

TACTI	DENSO	TT
267700-1210	IWM01-29	-
267700-1220	IWM01-31	-
267700-1230	IWM01-32	-
267700-1240	IWM01-34	-
267700-1260	IA01-31	-
267700-1270	IA01-32	-
267700-1280	IA01-34	-
267700-1310	IK01-24	-
267700-1320	IK01-27	-
267700-1330	IK01-31	-
267700-1340	IK01-34	-
267700-1360	IK02-24	-
267700-1370	IK02-27	-
267700-1380	IK02-31	-
267700-1410	IQ01-24	-
267700-1420	IQ01-27	-
267700-1430	IQ01-31	-
267700-1440	IQ01-34	-
267700-1460	IQ02-24	-
267700-1470	IQ02-27	-
267700-1480	IQ02-31	-
267700-1570	RU01-27	-
267700-1580	RU01-31	-
267700-1590	RU01-34	-
267700-2940	IAE01-32	-
267700-2950	IAE01-34	-
267700-4450	IKH01-24	-
267700-4460	IKH01-27	-
267700-4470	IKH01-31	-
V9110-2001	W16EXR-U11	W16TT
V9110-2002	W16EXR-U	W16TT
V9110-2003	K16R-U11	K16TT
V9110-2004	Q16R-U	Q16TT
V9110-2005	J16BR-U	-
V9110-2007	W20EXR-U	W20TT
V9110-2008	Q16R-U11	Q16TT
V9110-2010	K20R-U11	K20TT
V9110-2011	XU22EPR-U	XU22TT
V9110-2012	Q20R-U11	Q20TT
V9110-2013	IW20	IW20TT
V9110-2019	K20PR-L11	K20TT
V9110-2023	KJ20CR-L11	K20TT
V9110-2025	K20R-U	K20TT
V9110-2026	K16R-U	K16TT
V9110-2028	KJ16CR-L11	K16TT
V9110-2031	KJ16CR11	K16TT
V9110-2039	K22TNR-S	-
V9110-2040	K16TR11	K16TT
V9110-2041	K20TR11	K20TT
V9110-2042	K16PR-U11	K16TT
V9110-2043	K20PR-U11	K20TT
V9110-2044	W16EPR-U	W16TT
V9110-2045	Q20PR-U11	Q20TT
V9110-2046	Q16PR-U11	Q16TT
V9110-2047	K20PR-U	K20TT
V9110-2048	KJ16CR-U11	K16TT
V9110-2049	K20TNR-S9	K20TT
V9110-2110	PKJ16CR-L11	IK16TT
V9110-2111	PKJ20CR-L11	IK20TT
V9110-2301	IQ16	IQ16TT
V9110-2302	IQ20	IQ20TT
V9110-2303	IK16	IK16TT
V9110-2304	IK20	IK20TT
V9110-2305	IW16	IW16TT
V9110-2306	IW20	IW20TT
V9110-2307	IW22	-
V9110-2308	IXU22	-
V9110-2309	IXU24	-
V9110-2601	VQ16	IQ16TT
V9110-2602	VQ20	IQ20TT
V9110-2603	VK16	IK16TT

TACTI	DENSO	TT
V9110-2604	VK20	IK20TT
V9110-2605	VW16	IW16TT
V9110-2606	VW20	IW20TT
V9110-2607	VW22	-
V9110-2608	VXU22	-
V9110-2609	VXU24	-
V9110-3000	J16AR-U11	-
V9110-3001	J16BR-U	-
V9110-3002	J16BR-U	-
V9110-3006	Q16R-U11	Q16TT
V9110-3007	Q20PR-U	Q20TT
V9110-3009	Q20R-U11	Q20TT
V9110-3012	W14EXR-U11	IW16TT
V9110-3013	W14EXR-U	IW16TT
V9110-3014	W14EXR-U11	IW16TT
V9110-3016	W16EKR-S11	W16TT
V9110-3018	W16EPR-U	W16TT
V9110-3021	W16EPR-U	W16TT
V9110-3025	W16ESR-U	-
V9110-3029	W16EXR-U13	W16TT
V9110-3032	W16EXR-U11	W16TT
V9110-3033	W16FSR	-
V9110-3034	W16FSR	-
V9110-3035	W16LS	-
V9110-3037	W16PR-U	-
V9110-3041	W20EKR-S11	IW20TT
V9110-3043	W20EP-U	W20TT
V9110-3046	W20EPR-S11	W20TT
V9110-3047	W20EPR-U	W20TT
V9110-3049	W20EPR-U11	W20TT
V9110-3051	W20ESR-U	-
V9110-3057	W20ESR-U	-
V9110-3059	IW20	IW20TT
V9110-3060	IW20	IW20TT
V9110-3064	W20EXR-U11	W20TT
V9110-3068	W20FPR-U	WF20TT
V9110-3072	W20FSR-U	WF20TT
V9110-3073	W20FSR-U	WF20TT
V9110-3075	W20S-U	-
V9110-3076	W20SR-U	-
V9110-3085	W22EPR-U	W22TT
V9110-3088	W22EPR-U	W22TT
V9110-3093	W22ESR-U	-
V9110-3098	W22ESR-U	-
V9110-3105	IRE01-27	-
V9110-3110	W16ESR-U	-
V9110-3112	QJ20CR11	Q20TT
V9110-3114	P16PR11	W16TT
V9110-3119	K16R-U	K16TT
V9110-3120	K16R-U11	K16TT
V9110-3121	K20PR-U11	K20TT
V9110-3122	K20R-U	K20TT
V9110-3129	Q16R-U	Q16TT
V9110-3130	K16PR-U11	K16TT
V9110-3131	KJ16CR11	K16TT
V9110-3132	KJ16CR-L11	K16TT
V9110-3135	K16GPR-U11	-
V9110-3137	Q16PR-U	Q16TT
V9110-3139	K20R-U11	K20TT
V9110-3140	Q20R-U	Q20TT
V9110-3141	PK20PR-P11	K20TT
V9110-3142	PK20PR-L11	IK20TT
V9110-3143	K16PR-L11	K16TT
V9110-3144	K20PR-L11	K20TT
V9110-3145	K20PR-U	K20TT
V9110-3167	KJ14CR-L11	-
V9110-3168	PK20PR11	K20TT
V9110-3169	KJ20CR-L11	K20TT
V9110-3170	IW22	-
V9110-3174	PK16PR-P11	K16TT
V9110-3175	PKJ16CR8	-

TACTI	DENSO	TT
V9110-3178	XU20EPR-U	-
V9110-3179	XU22EPR-U	XU22TT
V9110-3180	XU24EPR-U	-
V9110-3181	Q16R-U11	Q16TT
V9110-3182	Q20R-U11	Q20TT
V9110-3183	Q14R-U11	IQ16TT
V9110-3184	Q16PR-U11	Q16TT
V9110-3185	Q20P-U11	Q20TT
V9110-3186	Q16PR-U11	Q16TT
V9110-3187	Q20PR-U11	Q20TT
V9110-3191	K16PR-U	K16TT
V9110-3192	K22PR-U11	-
V9110-3194	K16TR11	K16TT
V9110-3195	K20TR11	K20TT
V9110-3196	K20TNR-S	K20TT
V9110-3197	K22TNR-S	-
V9110-3199	W16EPR-U11	W16TT
V9110-3200	W22EPR-U11	W22TT
V9110-3201	W16EPR-U11	W16TT
V9110-3202	W14EX-U	IW16TT
V9110-3203	W16EXR-U	W16TT
V9110-3204	W20EX-U	W20TT
V9110-3205	W16EXR-U11	W16TT
V9110-3206	W20EXR-U11	W20TT
V9110-3208	VW20T	IW20TT
V9110-3210	W16EXR-U	W16TT
V9110-3211	W20EXR-U	W20TT
V9110-3212	W20EXR-U11	W20TT
V9110-3213	W16EXR-U13	W16TT
V9110-3214	VW20T	IW20TT
V9110-3215	W16ETR-S	W16TT
V9110-3216	W16ETR-S	W16TT
V9110-3220	J16AR-U11	-
V9110-3221	J16BR-U	-
V9110-3232	W16FPR-U	-
V9110-3235	QJ16AR-U	Q16TT
V9110-3236	QJ16CR11	Q16TT
V9110-3237	KJ14CR11	-
V9110-3245	PK20PR-P8	IK20TT
V9110-3247	PKJ20CR-L11	IK20TT
V9110-3249	IK22	-
V9110-3250	W20EPR-S11	W20TT
V9110-3251	IW22	-
V9110-3252	IRE01-31	-
V9110-3258	W16EKR-S11	W16TT
V9110-3262	K20PR-TP11	K20TT
V9110-3263	IK22	-
V9110-3264	PK16PR11	K16TT
V9110-3266	IQ16	IQ16TT
V9110-3268	W20FPR-U10	WF20TT
V9110-3293	IK16	IK16TT
V9110-3304	K20TNR	K20TT
V9110-3305	K20TNR-S9	K20TT
V9110-3311	KJ16CR-U11	K16TT
V9110-3329	K16TNR-S9	K16TT
V9110-3374	KJ20DR-M11	IK20TT
V9110-3381	K20HR-U11	KH20TT
V9110-3445	XU22HDR9	XUH22TT
V9110-3451	KJ20CR-U11	K20TT
V9110-3455	SKJ20DR-M11S	-
V9110-3456	IK20	IK20TT
V9110-3470	IK20G	-
V9110-4000	U16FSR-U	-
V9110-4002	U20FSR-U	-
V9110-4004	U20FSR-U	-
V9110-4006	U22FSR-U	-
V9110-4008	U22FSR-U	-
V9110-4012	W14F-U	-
V9110-4013	W14FPR-U	-
V9110-4014	W14FPR-UL	-
V9110-4019	W16FPR-U	-

TACTI	DENSO	TT
V9110-4021	W22FPR-U	-
V9110-4024	W22FSR	-
V9110-4025	W22FS-U	-
V9110-4027	W22S-U	-
V9110-4028	W24EPR-U	-
V9110-4030	W24ESR-U	-
V9110-4033	W24ESR-U	-
V9110-4034	W24ES-V	-
V9110-4037	W24FSR	-
V9110-4038	W24FSR	-
V9110-4045	W27ESR-U	-
V9110-4046	W27ESR-U	-
V9110-4047	W27ES-V	-
V9110-4052	W27FSR	-
V9110-4054	W27FSR	-
V9110-4062	W31ESR-U	-
V9110-4075	X16FSR-U	-
V9110-4076	X20ESR-U	-
V9110-4078	X20FSR-U	-
V9110-4080	X20FSR-U	-
V9110-4086	X22EPR-U9	-
V9110-4090	X22ESR-U	-
V9110-4091	X22ESR-U	-
V9110-4096	X24EPR-U9	-
V9110-4099	X24ESR-U	-
V9110-4101	X24ESR-U	-
V9110-4103	X24FS-U	-
V9110-4111	X27EPR-U9	-
V9110-4114	X27ESR-U	-
V9110-4116	X27ESR-U	-
V9110-4148	W16FPR-U	-
V9110-4149	W20FR-L	WF20TT
V9110-4150	X24GPR-U	-
V9110-4152	W9FP-UL	-
V9110-4157	X20ESR-U	-
V9110-4160	IWM31	-
V9110-5000	L14-U	-
V9110-5008	MA16PR-U	-
V9110-5013	MA20PR-U	-
V9110-5020	T14PR-U	ITF16TT
V9110-5022	T16EPR-U	T16TT
V9110-5023	T16EPR-U15	T16TT
V9110-5026	T16PR-U11	ITF16TT
V9110-5032	T20EPR-U	T20TT
V9110-5033	T20EPR-U15	T20TT
V9110-5036	T20PR-U11	ITF20TT
V9110-5040	T22EP-U	-
V9110-5044	W16S-U	-
V9110-5046	W20PR-U	-
V9110-5047	T16NR-U11	IT16TT
V9110-5048	T20NR-U11	IT20TT
V9110-5060	K20PBR	K20TT
V9110-5061	K20PBR-S10	K20TT
V9110-5062	K22PBR-S	-
V9110-5063	K20TXR	K20TT
V9110-5064	W16EPB10	W16TT
V9110-5065	W20EPB	W20TT
V9110-5066	W22EPB	W22TT
V9110-5070	PT16EPR-L13	IT16TT
V9110-5301	IQ16	IQ16TT
V9110-5302	IQ20	IQ20TT
V9110-5303	IK16	IK16TT
V9110-5304	IK20	IK20TT
V9110-5305	IW16	IW16TT
V9110-5306	IW20	IW20TT
V9110-5307	IW22	-
V9110-5308	IXU22	-
V9110-5309	IXU24	-
V9110-5310	IK22	-
V9110-5311	IK24	-
V9110-5312	IK27	-

TACTI	DENSO	TT
V9110-5313	IQ22	-
V9110-5314	IQ24	-
V9110-5315	IQ27	-
V9110-5316	IW24	-
V9110-5317	IW27	-
V9110-5318	IW29	-
V9110-5319	IW31	-
V9110-5320	IW34	-
V9110-5321	IK31	-
V9110-5322	IK34	-
V9110-5323	IQ31	-
V9110-5324	IQ34	-
V9110-5325	IT16	IT16TT
V9110-5326	IT20	IT20TT
V9110-5327	IT22	-
V9110-5328	IT24	-
V9110-5329	IT27	-
V9110-5330	ITF16	ITF16TT
V9110-5331	ITF20	ITF20TT
V9110-5332	ITF22	-
V9110-5333	ITF24	-
V9110-5334	ITF27	-
V9110-5337	IXU27	-
V9110-5338	ITV16	ITV16TT
V9110-5339	ITV20	ITV20TT
V9110-5340	ITV22	-
V9110-5341	ITV24	-
V9110-5342	ITV27	-
V9110-5343	IKH16	IKH16TT
V9110-5344	IKH20	IKH20TT
V9110-5345	IKH22	-
V9110-5346	IKH24	-
V9110-5347	IKH27	-
V9110-5348	IK22G	-
V9110-5349	ITL16	ITL16TT
V9110-5350	ITL20	-
V9110-5351	IK16G	-
V9110-5352	IK20G	-
V9110-5353	IXUH22	-
V9110-5356	IXUH22I	-
V9110-5359	IWF16	-
V9110-5360	IU20	-
V9110-5361	IU22	-
V9110-5362	IU24	-
V9110-5363	IU27	-
V9110-5364	IU31	-
V9110-5365	IU24A	-
V9110-5366	IU27A	-
V9110-5367	IU31A	-
V9110-5368	IUH24	-
V9110-5369	IUH27	-
V9110-5371	IX22	-
V9110-5372	IX24	-
V9110-5373	IX27	-
V9110-5375	IX22B	-
V9110-5376	IX24B	-
V9110-5377	IX27B	-
V9110-5378	IWF20	-
V9110-5379	IWF22	-
V9110-5380	IWF24	-
V9110-5381	IWF27	-
V9110-5383	IUF22	-
V9110-5384	IUF24	-
V9110-5391	IWM24	-
V9110-5392	IWM27	-
V9110-5393	IWM31	-
V9110-5394	IXG24	-
V9110-5395	IXG27	-
V9110-5501	VK20T	IK20TT
V9110-5502	VW20T	IW20TT
V9110-5601	VQ16	IQ16TT

Spark & Glow Plugs

Cross Reference Chart - OE

TACTI	DENSO	TT
V9110-5602	VQ20	IQ20TT
V9110-5603	VK16	IK16TT
V9110-5604	VK20	IK20TT
V9110-5605	VW16	IW16TT
V9110-5606	VW20	IW20TT
V9110-5607	VW22	-
V9110-5608	VXU22	-
V9110-5609	VXU24	-
V9110-5610	VK22	-
V9110-5611	VXUH22	-
V9110-5613	VQ22	-
V9110-5617	VKH16	IKH16TT
V9110-5618	VKH20	IKH20TT
V9110-5619	VKH22	-
V9110-5620	VK20Y	-
V9110-5621	VT16	IT16TT
V9110-5622	VKA16	-
V9110-5623	VKA20	-
V9110-5624	VKB16	-
V9110-5625	VKB20	-
V9110-5636	VK22G	-
V9110-5637	VCH20	IXEH22TT
V9110-5638	VT20	IT20TT
V9110-5639	VKH20Y	-
V9110-5640	VK16G	IK16TT
V9110-5641	VK20G	-
V9110-5643	VFKBH20	IKBH20TT
V9110-5644	VFXEH20E	IXEH20ETT
V9110-5645	VFXEH20	IXEH20TT
V9110-5646	VFXEH22	IXEH22TT
V9110-5647	VFK16	IK16TT
V9110-5654	VFKH16	IKH16TT
V9110-5655	VFKH20	IKH20TT
V9110-5656	VXUH22I	-
V9110-5719	IRE01-27	-
V9110-5720	IRE01-31	-
V9110-5721	IRE01-32	-
V9110-5722	IRE01-34	-
V9110-5752	IRT01-31	-
V9110-5753	IRT01-34	-
V9110-5754	IRL01-27	-
V9110-5755	IRL01-31	-
V9110-6004	W9-U	-
V9110-6008	W14PR-U	-
V9110-6009	W14E	-
V9110-6010	W14EPR-U	IW16TT
V9110-6011	W14EPR-U	IW16TT
V9110-6021	W14PR-U	-
V9110-6022	W20MR-U	-
V9110-6023	W20MP-U	-
V9110-6026	W22M-U	-
V9110-6027	W22MPR-U	-
V9110-6028	W27FSR-U10	-
V9110-6037	W20FPR-U10	WF20TT
V9110-6039	T20M-U	-
V9110-6041	T22M-U	-
V9110-6044	W9EXR-U+CU	-
V9110-6045	W9EP	-
V9110-6046	W9EXR-U+CU	-
V9110-6047	W24FSR-U10	-
V9110-6076	K16HPR-U11	KH16TT
V9110-7001	K16TT	K16TT
V9110-7002	K20TT	K20TT
V9110-7003	W16TT	W16TT
V9110-7004	XU22TT	XU22TT
V9110-7005	XUH22TT	XUH22TT
V9110-7006	XUH20TTi	XUH20TTi

TOYOTA	DENSO	TT
0419534020	W20EP-U	W20TT
08922-01017-83	W20EXR-U11	W20TT

TOYOTA	DENSO	TT
0892201018	W16EX-U	W16TT
08922-01018	W16EX-U	W16TT
0892201019	W16EXR-U11	W16TT
08922-01019	W16EXR-U11	W16TT
19111U2120	T14PR-U	ITF16TT
19111-U2120-71	T14PR-U	ITF16TT
19850-05010	DG-212	-
19850-0L010	DG-245	-
19850-0R010	DG-600	-
19850-0R020	DG-600	-
19850-0R022	DG-600	-
19850-0W010	DG-240	-
19850-26010	DG-600	-
19850-26020	DG-600	-
19850-26021	DG-600	-
19850-26022	DG-600	-
19850-27010	DG-245	-
19850-30010	DG-245	-
19850-46021	DG-224	-
19850-46030	DG-225	-
19850-46031	DG-225	-
19850-54010	DG-211	-
19850-54020	DG-238	-
19850-54030	DG-221	-
19850-54031	DG-221	-
19850-54050	DG-215	-
19850-54060	DG-239	-
19850-54070	DG-213	-
19850-54071	DG-213	-
19850-54090	DG-211	-
19850-54110	DG-310	-
19850-54120	DG-212	-
19850-54130	DG-310	-
19850-54140	DG-242	-
19850-54150	DG-218	-
19850-56010	DG-226	-
19850-56011	DG-226	-
19850-56012	DG-226	-
19850-56020	DG-227	-
19850-56021	DG-234	-
19850-56022	DG-234	-
19850-58010	DG-219	-
19850-64010	DG-223	-
19850-64020	DG-216	-
19850-64030	DG-214	-
19850-64040	DG-308	-
19850-64050	DG-214	-
19850-64060	DG-309	-
19850-64061	DG-309	-
19850-67020	DG-305	-
19850-67030	DG-305	-
19850-68010	DG-232	-
19850-68020	DG-233	-
19850-68030	DG-234	-
19850-68040	DG-235	-
19850-68050	DG-220	-
19850-68051	DG-220	-
19850-68060	DG-222	-
19850-76001	DG-226	-
19850-76004	DG-232	-
19850-76005	DG-234	-
19850-76008	DG-231	-
19850-76010	DG-224	-
19850-76011	DG-225	-
19850-76012	DG-233	-
19850-76013	DG-228	-
19850-76020	DG-228	-
19850-77010	DG-231	-
19850-77011	DG-231	-
19850-78020	DG-241	-
8009876005	W16S-U	-

TOYOTA	DENSO	TT
80098-76005	W16S-U	-
8091976008	W20EX-U	W20TT
80919-76008	W20EX-U	W20TT
8091976011	W9EP	-
80919-76011	W9EP	-
8091976012	K16R-U	K16TT
80919-76012	K16R-U	K16TT
8922010168	W16EXR-U	W16TT
89220101683	W16EXR-U	W16TT
89220101783	W20EXR-U11	W20TT
89220-10208	PQ16R	Q16TT
90048-51185	SK20HR11	IKH20TT
90048-51208	VXUH20I	-
9004A-91011	K20R-U	K20TT
9004A-91031	XU22PR9	XU22TT
9004A-91032	XU22PR9	XU22TT
9004A-91039	XU22PR9	XU22TT
90080-91032	Q16R-U11	Q16TT
90080-91048	K20R-U	K20TT
90080-91065	PK20R13	K20TT
90080-91066	K20R-U	K20TT
90080-91108	K20R-U	K20TT
90080-91116	PK20TR11	K20TT
90080-91145	K16TR11	K16TT
90080-91159	SK20R-P13	IK20TT
9008091161	K16R-U11	K16TT
90080-91161-A	K16R-U11	K16TT
9008091180	SK20R11	IK20TT
90080-91180-B	SK20R11	IK20TT
90080-91184	SK16R11	IK16TT
90080-91193	K16R-U11	K16TT
90080-91193-B	K16R-U11	K16TT
9008091194	K16R-U11	K16TT
90080-91200	K16R-U11	K16TT
90080-91204	K20R-U11	K20TT
90080-91217	K16R-U11	K16TT
90080-91229	K16R-U	K16TT
90080-91234	W16EXR-U	W16TT
90080-91235	W16EXR-U11	W16TT
9008091236	W16EXR-U11	W16TT
90080-91236-A	W16EXR-U11	W16TT
9008091237	W16EXR-U	W16TT
90080-91237-A	W16EXR-U	W16TT
90080-91243	K20R-U	K20TT
90098-09125	W9EP	-
90098-14125	W14EX-U	IW16TT
90098-14395	W14EX-U	IW16TT
90098-14595	W14EX-U	IW16TT
90098-14715	W14PR-U	-
90098-14785	T14PR-U	ITF16TT
90098-16395	W16EX-U	W16TT
90098-16505	W16ES-U	-
90098-16705	T16P-U	ITF16TT
90098-16785	T16PR-U	ITF16TT
90098-20276	W16S-U	-
90098-20395	W20EX-U	W20TT
90098-20785	T20PR-U	ITF20TT
90098-64015	L14-U	-
9091601176	K16R-U	K16TT
90916-01176	K16R-U	K16TT
90919-01020	W16EXR-U	W16TT
90919-01026	W14EX-U	IW16TT
90919-01027	W16EXR-U	W16TT
90919-01041	W16EX-U	W16TT
90919-01045	W20EXR-U	W20TT
90919-01046	W20EX-U	W20TT
90919-01050	W14EX-U	IW16TT
9091901051	W16EPR-U	W16TT
90919-01051	W16EPR-U	W16TT
90919-01053	W14EPR-U	IW16TT

TOYOTA	DENSO	TT
90919-01055	W9EP	-
90919-01056	W14EX-U	IW16TT
90919-01057	W20EPR-U	W20TT
90919-01059	W16EXR-U	W16TT
90919-01064	W16EXR-U	W16TT
90919-01065	W14EXR-U	IW16TT
90919-01083	W20EX-U	W20TT
90919-01084	W20EXR-U	W20TT
90919-01085	W14EXR-U11	IW16TT
90919-01087	W16ETR-S	W16TT
90919-01088	IW20	IW20TT
90919-01089	IW20	IW20TT
90919-01090	W16ETR-S	W16TT
90919-01091	W16EXR-U11	W16TT
90919-01092	IW20	IW20TT
90919-01094	W16EXR-U11	W16TT
90919-01095	W16ETR-S	W16TT
90919-01096	W16ETR-S	W16TT
90919-01097	IW20	IW20TT
90919-01098	W20EXR-U	W20TT
90919-01100	T16EPR-U	T16TT
90919-01102	W16EXR-U	W16TT
90919-01103	W14EXR-U	IW16TT
90919-01104	W16EXR-U11	W16TT
90919-01108	W16EXR-U11	W16TT
90919-01109	W14EXR-U11	IW16TT
90919-01113	J16AR-U11	-
90919-01114	J16AR-U11	-
90919-01115	P16R	W20TT
90919-01116	P16R	W20TT
90919-01117	J16BR-U	-
90919-01118	J16BR-U	-
90919-01119	J16BR-U	-
90919-01120	J16AR-U11	-
90919-01121	PQ16R	Q16TT
90919-01122	PQ16R	Q16TT
90919-01123	J16BR-U	-
90919-01125	W20EXR-U11	W20TT
90919-01126	W20EXR-U11	W20TT
90919-01127	PQ20R	Q20TT
90919-01128	PQ20R	Q20TT
90919-01129	Q16R-U11	Q16TT
90919-01131	Q20R-U11	Q20TT
90919-01133	P16R13	W20TT
90919-01134	P16R13	W20TT
90919-01135	VQ20	IQ20TT
90919-01136	VQ20	IQ20TT
90919-01139	W20EXR-U11	W20TT
90919-01141	VQ16	IQ16TT
90919-01143	P16R	W20TT
90919-01144	P16R	W20TT
90919-01145	PQ20R-P8	IQ20TT
90919-01146	PQ20R-P8	IQ20TT
90919-01149	Q20R-U	Q20TT
90919-01151	PQ16R8	Q16TT
90919-01152	PQ16R8	Q16TT
90919-01153	Q16R-U	Q16TT
90919-01155	QJ16AR-U	-
90919-01157	IQ16	IQ16TT
90919-01158	IQ16	IQ16TT
90919-01159	Q16R-U11	Q16TT
90919-01161	PQ20R	Q20TT
90919-01162	PQ20R	Q20TT
90919-01164	K16R-U11	K16TT
90919-01165	K16R-U11	K16TT
90919-01166	K20R-U	K20TT
90919-01168	PK16R11	K16TT
90919-01169	PK16R11	K16TT
90919-01170	Q14R-U11	IQ16TT
90919-01172	PK20R-P8	IK20TT
90919-01173	PK20R-P8	IK20TT

Spark & Glow Plugs

Cross Reference Chart - OE

TOYOTA	DENSO	TT
90919-01174	QJ16AR-U11	-
90919-01176	K16R-U	K16TT
90919-01177	K16R-U	K16TT
90919-01178	PK20R11	K20TT
90919-01179	PK20R11	K20TT
90919-01180	PK20R8	IK20TT
90919-01181	PK20R8	IK20TT
90919-01182	PQ20R	Q20TT
90919-01184	K20R-U11	K20TT
90919-01185	K20R-U11	K20TT
90919-01187	PK20R13	K20TT
90919-01188	PK20R13	K20TT
90919-01190	VK20T	IK20TT
90919-01191	SK20HR11	IKH20TT
90919-01192	K16TR11	K16TT
90919-01193	K16TR11	K16TT
90919-01194	PK20TR11	K20TT
90919-01195	PK20TR11	K20TT
90919-01196	PK16TR11	K16TT
90919-01197	PK16TR11	K16TT
90919-01198	K20TR11	K20TT
90919-01200	PK16TR13	IK16TT
90919-01201	PK16TR13	IK16TT
90919-01202	K20TR11	K20TT
90919-01205	PK16R8	IK16TT
90919-01206	PK16R8	IK16TT
90919-01207	SK20R-P11	IK20TT
90919-01208	PK20GR8	-
90919-01209	SK16R-P11	IK16TT
90919-01210	SK20R11	IK20TT
90919-01211	SK20R11	IK20TT
90919-01212	SK20R-P13	IK20TT
90919-01213	PK20GR8	-
90919-01214	SK16R-P8	IK16TT
90919-01215	SK16R-P8	IK16TT
90919-01217	SK16R11	IK16TT
90919-01218	SK16R11	IK16TT
90919-01219	SK16R-P11	IK16TT
90919-01220	PK20R11	K20TT
90919-01221	SK20BGR11	-
90919-01223	IW16	IW16TT
90919-01224	IW16	IW16TT
90919-01225	SK20R-P11	IK20TT
90919-01226	SK20BR11	-
90919-01229	SK20R5-G	-
90919-01230	SK20BR11	-
90919-01231	VK20Y	-
90919-01233	SK16HR11	IKH16TT
90919-01235	K20HR-U11	KH20TT
90919-01236	K20HR-U11	KH20TT
90919-01237	SK20R11	IK20TT
90919-01238	SK20R11	IK20TT
90919-01239	VK20T	IK20TT
90919-01240	SK16R11	IK16TT
90919-01241	SK16R11	IK16TT
90919-01242	K16R-U11	K16TT
90919-01243	VFKH16	IKH16TT
90919-01244	K16R-U	K16TT
90919-01245	K16R-U	K16TT
90919-01247	FK20HR11	IKH20TT
90919-01248	FK20HR11	IKH20TT
90919-01249	FK20HR11	IKBH20TT
90919-01250	VW20T	IW20TT
90919-01252	FK16R11	IK16TT
90919-01253	SC20HR11	IKH20TT
90919-01258	K16HR-U11	KH16TT
90919-01259	FK16HR-A8	-
90919-01265	FK16R-A8	-
90919-01275	SC16HR11	IKH20TT
90919-01286	FK16HBR-J8	-
90919-01950	W9EP	-

TOYOTA	DENSO	TT
90919-01954	W9EXR-U+CU	-
90919-22357	W16EXR-U	W16TT
90919-91048	PK20R13	K20TT
90919-91066	PK20R13	K20TT
90919-A1002	SK20HR11	IKH20TT
90919-A1003	SK16HR11	IKH16TT
90919-C1006	FK16HBR-J8	-
90919-T1002	K16R-U	K16TT
90919-T1002-A	K16R-U	K16TT
90919-T1003	K16R-U11	K16TT
90919-T1004-A	K20HR-U11	KH20TT
90919-T1005	K20HR-U11	KH20TT
90919-T1006	SK20HR11	IKH20TT
90919-T1007	SK20R11	IK20TT
90919-T1007-A	SK20R11	IK20TT
90919-T1009	SC20HR11	IKH20TT
90919-W1001	K16HR-U11	KH16TT
90919-W1002	SK20HR11	IKH20TT
90919-W1003	SK16HR11	IKH16TT
90919-YZZAA	Q16R-U	Q16TT
90919-YZZAB	Q20R-U	Q20TT
90919-YZZAC	Q20R-U11	Q20TT
90919-YZZAD	K16R-U	K16TT
90919-YZZAE	K16R-U11	K16TT
90919-YZZAF	K20R-U	K20TT
90919-YZZAG	K20R-U11	K20TT
90999-09001	W20EP-U	W20TT
90999-09002	T20R-U	-
90999-09006	W16EXR-U	W16TT
90999-09007	W20EX-U	W20TT
SU00100351	DG-003	-
SU00100671	DG-113	-
SU001A1261	DG-603	-
SU00300416	VXEBH27	-

TRD	DENSO	TT
10901SP00324	IW24	-
10901SP04127	IK01-27	-
10901SP04129	IK01-31	-
10901SP04131	IK01-31	-
19059SP00422	IK22	-
19059SP00424	IK24	-
19059SP00427	IK27	-
TRDIK16X	IK16	IK16TT
TRDIK20X	IK20	IK20TT
TRDIK22	IK22	-
TRDIK24	IK24	-
TRDIK27	IK27	-
TRDK31AZ	IK31	-

VAUXHALL	DENSO	TT
25193473	KJ20CR-L11	K20TT
55200755	DG-608	-
55564219	DG-621	-
55571391	PK20PR-L11	IK20TT
90019495	DK-001	-
90464737	DG-133	-
90509368	DG-001	-
9111145	DG-004	-
91143773	W20FPR-U	WF20TT
9118201	DG-118	-
93183990	DG-133	-
93187927	DG-302	-
93191771	DG-608	-
94133759	DG-108	-
94140115	DG-108	-
94175158	DG-108	-
95508492	DG-312	-
97210818	DG-302	-
97358626	DG-302	-
97389905	DG-302	-

VOLKSWAGEN	DENSO	TT
004081161A	K20PR-U	K20TT
03C905601A	PKJ20CR8	-
03C905601A	SKJ20CR-A8	-
03C905601B	SKJ20CR-A8	-
03L963319	DG-193	-
03L963319A	DG-193	-
059963319	DG-144	-
059963319A	DG-144	-
059963319C	DG-193	-
059963319E	DG-193	-
059963319F	DG-193	-
059963319H	DG-144	-
059963319J	DG-193	-
059998319	DG-193	-
061905061	DG-012	-
062905061	DG-139	-
062905061A	DG-183	-
068905061	DG-012	-
06E905611	VK20	IK20TT
06H905601A	PK22PR8	-
06H905604	VK22	-
06H905611	PK22PR8	-
06H905621	PK22PR8	-
079905626B	VKH22	-
079905626E	VKH22	-
101000000AA	W22EPR-U	W22TT
101000000AB	W20EPR-U	W20TT
101000000AC	W16EPR-U	W16TT
101000001AA	W22EPB	W22TT
101000001AB	W20EPB	W20TT
101000001AC	W20EPB	W20TT
101000001AD	W16EPB10	W16TT
101000001AE	W16EPB10	W16TT
101000002AA	W16EPR-U	W16TT
101000002AB	W20EPR-U	W20TT
101000002AC	W20EPR-U	W20TT
101000002AD	W22EPR-U	W22TT
101000002AE	IW20	IW20TT
101000003AA	K22PB	-
101000004AA	K22PB	-
101000004AB	K20PBR-S10	K20TT
101000005AA	W20EPB	W20TT
101000005AB	W20EPB	W20TT
101000005AC	W22EPB	W22TT
101000005AD	W16EPB10	W16TT
101000005AE	W16EPB10	W16TT
101000005AF	W16EPB10	W16TT
101000006AA	W22EPR-U	W22TT
101000006AB	W20EPR-U	W20TT
101000006AC	W20EPR-U	W20TT
101000006AD	W16EPR-U	W16TT
101000006AF	IW20	IW20TT
101000007AA	W20EPB	W20TT
101000007AB	W20EPB	W20TT
101000007AC	W16EPB10	W16TT
101000007AD	W20EPB	W20TT
101000009AA	W20ESR-U	-
101000010AB	T20EPR-U	T20TT
101000012AA	W20ESR-U	-
101000013AA	IK20	IK20TT
101000014AA	K22PBR-S	-
101000014AB	K20PBR-S10	K20TT
101000015AA	T20EPR-U	T20TT
101000016AA	PK22PR8	-
101000016AB	PK20PR-P8	IK20TT
101000017AA	K22PB	-
101000017AB	K20PBR-S10	K20TT
101000018AA	W16EPR-U	W16TT
101000019AA	W16EPR-U	W16TT
101000020AA	W16EPR-U	W16TT
101000021AA	W20EPB	W20TT

VOLKSWAGEN	DENSO	TT
101000025AA	K20TXR	K20TT
101000026AA	W20EPBR-S	W20TT
101000026AB	W20EPBR-S	W20TT
101000027AA	W20EPB	W20TT
101000027AB	W16EPB10	W16TT
101000027AC	W16EPB10	W16TT
101000028AA	K22PB	-
101000029AA	T20EPR-U	T20TT
101000029AB	T20EPR-U	T20TT
101000031AA	K20TXR	K20TT
101000031AB	IK22	-
101000033AA	K20PBR-S10	K20TT
101000033AB	K22PBR-S	-
101000033AC	K16TNR-S9	K16TT
101000033AF	K20PBR-S10	K20TT
101000033AG	K16TNR-S9	K16TT
101000034AA	W20EPR-U	W20TT
101000035AA	K20TXR	K20TT
101000035AB	K20TXR	K20TT
101000035AE	IK22	-
101000035AH	K20TXR	K20TT
101000035HJ	K20TXR	K20TT
101000036AA	W20EPBR-S	W20TT
101000036AB	W20EPBR-S	W20TT
101000036AC	W20EPBR-S	W20TT
101000038AA	W16ETR-S	W16TT
101000038AB	W16ETR-S	W16TT
101000039AA	W16ETR-S	W16TT
101000039AB	W16ETR-S	W16TT
101000040AC	W20EPBR-S	W20TT
101000040AD	W20EPBR-S	W20TT
101000040AE	W20EPBR-S	W20TT
101000041AC	K20PBR-S10	K20TT
101000041AD	K20PBR-S10	K20TT
101000041AE	K22PBR-S	-
101000044AA	IK16	IK16TT
101000045AA	IK22	-
101000047AA	W16EPR-U	W16TT
101000047AB	P20PR11	W20TT
101000049AC	IK16	IK16TT
101000049AD	IK20	IK20TT
101000049AE	K16PR-U	K16TT
101000049AF	K16PR-U	K16TT
101000050AA	W20EPBR-S	W20TT
101000050AB	W20EPBR-S	W20TT
101000050AC	W20EPBR-S	W20TT
101000051AA	K20PBR-S10	K20TT
101000051AB	K22PBR-S	-
101000052AA	T20EPR-U	T20TT
101000052AB	T20EPR-U	T20TT
101000053AA	PK16R8	IK16TT
101000054AC	K20PBR-S10	K20TT
101000054AD	K20PBR-S10	K20TT
101000055AA	K20TXR	K20TT
101000060AA	K16TNR-S9	K16TT
101000062AA	VKA20	-
101000062AB	PKJ16CR-L11	IK16TT
101000063AA	PK20PR-P8	IK20TT
101000063AC	PK22PR8	-
101000065AA	K20PBR	K20TT
101000067AA	K20TXR	K20TT
101000068AA	K20PBR-S10	K20TT
101000068AA	K20PBR-S10	K20TT
101905115	PKJ20CR8	-
101905600	SKJ16CR-L11	IK16TT
101905600A	PKJ20CR-L11	IK20TT
101905600C	SKJ16CR-L11	IK16TT
101905601	PKJ16CR-L11	IK16TT
101905601B	KJ16CR-L11	K16TT
101905601F	KJ20DR-M11	IK20TT
101905603B	KJ16CR-L11	K16TT

Spark & Glow Plugs

Cross Reference Chart - OE

VOLKSWAGEN	DENSO	TT
101905607	K20TXR	K20TT
101905608AA	K20PBR-S10	K20TT
101905610A	K20PR-U	K20TT
101905610B	IK20	IK20TT
101905611	PK20PR-L11	IK20TT
101905611A	PK20PR-L11	IK20TT
101905611B	PK22PR8	-
101905611D	VK20	IK20TT
101905611G	IK24	-
101905615A	K20PBR-S10	K20TT
101905616	K20PBR-S10	K20TT
101905617	KJ16CR-L11	K16TT
101905617A	KJ16CR-L11	K16TT
101905617C	KJ20DR-M11	IK20TT
101905618	KJ16CR-L11	K16TT
101905618A	KJ16CR-L11	K16TT
101905620	VKA16	-
101905621	IK22	-
101905621A	VKB20	-
101905621B	VKB20	-
101905621C	VK22	-
101905622	VXUHC22G	-
101905626	PKJ20CR8	-
101905626B	PKJ20CR8	-
101905631	VK22	-
101905631A	PK20PR-L11	IK20TT
101905631B	PK22PR8	-
101905631C	PK20PR-P8	IK20TT
101905631E	PK20PR-L11	IK20TT
101905631F	VK20	IK20TT
101905631G	VK22	-
101905631H	PK22PR8	-
101905640	IK22	-
101905640A	VKB20	-
101905640D	VKB20	-
101905641	VKH22	-
101935631G	VK22	-
10195631B	PK22PR8	-
10213002	DG-012	-
10591602	DG-177	-
10591603	DG-177	-
191905450	W20EPB	W20TT
191905450A	W20EPB	W20TT
191905450J	K22PB	-
191905451J	K22PB	-
194917764	K16PR-U	K16TT
194917864	Q22PR-U	-
197917764	K16PR-U	K16TT
199917764	K16PR-U	K16TT
199917766	K20PR-U	K20TT
3090599916	W22EPR-U	W22TT
3L963319	DG-193	-
3L963319A	DG-193	-
410905619	IU24	-
59963319A	DG-144	-
59963319C	DG-193	-
59963319E	DG-193	-
59963319F	DG-193	-
59963319H	DG-144	-
59963319J	DG-193	-
62905061A	DG-183	-
6U0000156	K16PR-U	K16TT
J1985054090	DG-211	-
J9091901064	W16EXR-U	W16TT
JZW905603A	PKJ16CR-L11	IK16TT
JZW905603D	K20PBR-S10	K20TT
N0178011	W16FSR	-
N01780113	W20FSR-U	WF20TT
N01781124	W16ESR-U	-
N01781130	W22ESR-U	-
N01781139	W20EPR-U	W20TT

VOLKSWAGEN	DENSO	TT
N01781144	IW22	-
N01781155	W20EPR-U	W20TT
N01781159	W22EPR-U	W22TT
N01781171	W22EPR-U	W22TT
N01781175	W20EPR-U	W20TT
N01781213	W20EPR-U	W20TT
N01781216	W22ESR-U	-
N01781234	W16EPR-U	W16TT
N01781236	W20EPR-U	W20TT
N01781240	W20EPR-U	W20TT
N01781241	W16EPR-U	W16TT
N01781244	W22EPR-U	W22TT
N01781249	W20EPB	W20TT
N01781253	W20EPR-U	W20TT
N01781333	W20EPR-U	W20TT
N0190811	DG-012	-
N0190812	DG-012	-
N0190814	DG-012	-
N0190971	DG-012	-
N01910005	DG-012	-
N0191001	DG-012	-
N0191002	DG-012	-
N0191005	DG-012	-
N0191006	DG-012	-
N0191006	DG-012	-
N10140101	DG-005	-
N10140102	DG-005	-
N10140103	DG-005	-
N10140104	DG-005	-
N10140105	DG-005	-
N10213001	DG-012	-
N10213002	DG-012	-
N10579201	DG-109	-
N10579202	DG-109	-
N10579802	DG-190	-
N10579804	DG-190	-
N10591602	DG-177	-
N10591603	DG-177	-

VOLVO	DENSO	TT
109X9146775	K20PBR-S10	K20TT
1257141	DG-012	-
1257889	DG-012	-
1269915	T20EPR-U	T20TT
1306604	W22EPR-U	W22TT
13066048	W20EPR-U	W20TT
1306605	W20EPR-U	W20TT
1346541	W20EPR-U	W20TT
13465414	W20EPR-U	W20TT
1357826	IWF22	-
1357827	IWF22	-
1357828	W20FPR-U	WF20TT
135827	W20FPR-U	WF20TT
1367015	W22EPR-U	W22TT
1367526	W20EX-U	W20TT
1367527	W22EPR-U	W22TT
1367528	W20EPR-U	W20TT
1367528-5	W20EPR-U11	W20TT
1367529	W20EPR-U	W20TT
1367529.3	W20EPR-U	W20TT
1389896	T22EP-U	-
1542319	DG-202	-
1667529	W16EPR-U	W20TT
20554214	GE3-1	-
20700468	GE3-F	-
207X9146775	K20PBR-S10	K20TT
241402	W20FPR-U	WF20TT
270746-1	W20EPR-U	W20TT
2707479	W22EPR-U	W22TT
271239	VKB20	-
271239-6	VKB20	-
271409-5	W20EPR-U	W20TT

VOLVO	DENSO	TT
2714152	W22EPR-U	W22TT
2714277	K20PR-U	K20TT
271603	K20PR-U	K20TT
2716033	K22PR-U	-
2716363	K20PR-U	K20TT
271727	K20PR-U	K20TT
2717270	K20PBR-S10	K20TT
271758	IK22	-
2717668	IK22	-
272207	K20PBR	K20TT
2722072	VT20	IT20TT
2723138	IK22	-
272344	PK20PR-P8	IK20TT
272344-3	VK22	-
272372	K20PBR-S10	K20TT
272767	PK20PR-P8	IK20TT
2735967	W22EPR-U	W22TT
2735975	W20EPR-U	W20TT
2735991	T20EPR-U	T20TT
304X9146775	K20PBR-S10	K20TT
30637308	IK22	-
30637385	IKH22	-
30650379	IKH22	-
30650843	K20HR-U11	KH20TT
30711106	DG-113	-
30713859	IKH22	-
30725069	DG-181	-
30725678	DG-603	-
30731383	SK20PR-A11	IK20TT
30731425	PT16VR13	TV16TT
30751468	VKH22	-
30751805	VKH22	-
30751806	VKH22	-
30758130	ITV20	ITV20TT
30758131	ITV22	-
30777349	ZT20EPR11	T20TT
30862690	DG-101	-
31216183	VKH20Y	-
31216184	VKH20Y	-
31216248	DG-180	-
31216525	ZT20EPR11	T20TT
31216674	VKH20Y	-
31251481	PT16VR13	TV16TT
31272399	VKH20Y	-
31272427	PT16VR13	TV16TT
31286359	VFKH20	IKH20TT
31293000	VFKH20	IKH20TT
31312691	VFKH20	IKH20TT
31330212	DG-603	-
32133274	W22EPR-U	W22TT
32705069	J16CR-U	W16TT
33443151	W16EPR-U	W16TT
33444720	J16CR-U	W16TT
33444738	J16CR-U	W16TT
33448986	W22EPR-U	W22TT
33448994	W22EPR-U	W22TT
3517629	K22PR-U	-
3517980	K20PR-U	K20TT
402X9146775	K20PBR-S10	K20TT
6470058	IK20	IK20TT
8631607	DG-140	-
8642660	K20PBR-S10	K20TT
8642661	K20PBR-S10	K20TT
8653104	IK20	IK20TT
8653698	DG-181	-
8653880	DG-610	-
8658474	IKH22	-
8670057	PK20PR-P8	IK20TT
8670058	IK22	-
8670059	IK22	-
8692070	PK20PR-P8	IK20TT

VOLVO	DENSO	TT
8692071	PK20PR-P8	IK20TT
8692072	PK20PR-P8	IK20TT
8694749	IT20	IT20TT
9135871	IK22	-
9146775	K20PBR-S10	K20TT
917910	PK20PR-P8	IK20TT

YAMAHA	DENSO	TT
90793-20018	IW31	-
90793-20029	IW29	-
90793-20030	IW01-32	-
90793-20032	IW31	-
90793-20033	U24ES-N	-
90793-20034	U27ES-N	-
90793-20139	W24EMR-C	-
90793-20150	IU24	-
90793-20151	IU27	-
90793-20152	IX24	-
90793-20153	IX27	-
90793-20154	IX24B	-
90793-20155	IX27B	-
90793-20156	IWF20	-
90793-20157	IWF22	-
90793-20158	IWF22	-
90793-20159	IWF22	-
90793-20160	IW24	-
90793-20161	IW27	-
90793-20162	IUH24	-
90793-20163	IUH27	-
90793-20164	IWF24	-
90793-20165	IW31	-
90793-20166	IWF24	-
90793-20167	IW16	IW16TT
90793-20168	IW20	IW20TT
90793-20170	IUF22	-
90793-20171	IUF22	-
90793-20172	IU22	-
90793-20173	IX22B	-
90793-20174	IUF24	-
90793-20175	IW22	-
90793-22008	W16ESR-U	-
90793-22010	W27ESR-U	-
90793-22035	W20ESR-U	-
90793-22036	W22ESR-U	-
90793-22037	W27ESR-U	-
90793-22039	W24FSR	-
90793-22045	W20EXR-U11	W20TT
90793-22047	X22EPR-U9	-
90793-22088	IW24	-
90793-22089	IW27	-
90793-22090	IW29	-
90793-22091	IW31	-
90793-22092	IW34	-
90793-22093	IU22	-
90793-22094	IU24	-
90793-22095	IU27	-
90793-22096	IUH24	-
90793-22097	IUH27	-
90793-22098	IX22B	-
90793-22099	IX24B	-
90793-22100	IX27B	-
90793-22101	IW22	-
90793-22102	IU31	-
90793-22103	IU24A	-
90793-22104	IU27A	-
90793-22105	IU31A	-
90793-22106	IX22	-
90793-22107	IX24	-
90793-22108	IX27	-
90793-22109	IWF22	-
90793-22110	IWF24	-

Spark & Glow Plugs

Cross Reference Chart - OE

YAMAHA	DENSO	TT
90793-22111	IWF27	-
90793-22112	IW16	IW16TT
90793-22114	IUF22	-
90793-22115	IUF24	-
9079E-ND001	W16FSR	-
9079E-ND002	W20FSR-U	WF20TT
9079E-ND004	W22FS-U	-
9079E-ND006	W24FSR	-
9079E-ND007	W24FSR-U10	-
9079E-ND008	W27FSR	-
9079E-ND009	W27FSR-U10	-
9079E-ND010	W16FSR	-
9079E-ND011	W20FSR-U	WF20TT
9079E-ND012	W22FSR	-
9079E-ND013	W24FSR	-
9079E-ND014	W24FSR-U10	-
9079E-ND015	W27FSR	-
9079E-ND016	W27FSR-U10	-
9079E-ND017	U20FSR-U	-
9079E-ND019	U22FSR-U	-
9079E-ND020	W14FPR-UL	-
9079E-ND021	W16ESR-U	-
9079E-ND022	W20EP-U	W20TT
9079E-ND023	W20FPR-U	WF20TT
9079E-ND024	W20FPR-U	WF20TT
9079E-ND026	W22EPR-U	W22TT
9079E-ND027	W22EPR-U	W22TT
9079E-ND028	W22FPR-U	-
9079E-ND030	W24ESR-U	-
9079E-ND031	W24ESR-U	-
9079E-ND032	W24EPR-U	-
9079E-ND033	W24FP-U	-
9079E-ND035	W27ESR-U	-
9079E-ND036	W27ESR-U	-
9079E-ND037	X22EPR-U9	-
9079E-ND038	X24EPR-U9	-
9079E-ND039	X24ESR-U	-
9079E-ND040	W22FPR-U	-
9079E-ND041	U20FSR-U	-
9079E-ND042	W22ESR-U	-
9079E-ND043	X22ESR-U	-
9079E-ND044	X24ESR-U	-
9079E-ND045	U27ES-N	-
9079E-ND046	W20FPR-U10	WF20TT
9079E-ND049	X20FSR-U	-
9079E-ND050	X24FS-U	-
9079E-ND051	U16FSR-U	-
9079E-ND052	W22FP-U10	-
9079E-ND053	W22EPR-U11	W22TT
9079E-ND055	W16FPR-U	-
9079E-ND056	X27GPR-U	-
9079E-ND057	U22FSR-U	-
9079E-ND058	U24ESR-N	-
9079E-ND059	U27ESR-N	-
9079E-ND060	X20EPR-U9	-
9079E-ND067	IWF20	-
9079E-ND069	X27EPR-U9	-
9079E-ND070	X22EPR-U9	-
9079E-ND071	W20EPR-U	W20TT
9079E-ND072	W16EPR-U	W16TT
9079E-ND073	X24EPR-U9	-
9079E-ND075	W16EPR-U	W16TT
9079E-ND077	W9EXR-U+CU	-
9079E-ND078	X22ESR-U	-
9079E-ND079	X27ESR-U	-
9079E-ND081	K16HPR-U11	KH16TT
9079E-ND084	IWF20	-
9079E-ND085	W20MR-U	-
9079Q-30501	U27ESR-N	-
90890-78079	IW20	IW20TT
90890-78082	IW31	-

YAMAHA	DENSO	TT
90890-78086	W24ESR-U	-
90890-78094	W20FSR-U	WF20TT
90890-78097	W14FPR-UL	-
90890-78102	W20MR-U	-
90890-78110	IW27	-
90890-78111	IW29	-
90890-78112	IW31	-
90893-22113	IW20	IW20TT
94700-00248	W22FSR	-
94700-00834	U22FSR-U	-
94700-00886	U22FSR-U	-
94701-00039	W20FSR-U	WF20TT
94701-00040	W22FS-U	-
94701-00041	W24FSR	-
94701-00042	W27FSR	-
94701-00043	W20ESR-U	-
94701-00044	W22ESR-U	-
94701-00045	W24ESR-U	-
94701-00046	W27ESR-U	-
94701-00048	IWF24	-
94701-00050	W22FPR-U	-
94701-00061	IW24	-
94701-00063	IW27	-
94701-00069	W16FSR	-
94701-00078	W16ESR-U	-
94701-00108	W20FPR-U	WF20TT
94701-00110	W22FSR	-
94701-00111	W20ESR-U	-
94701-00112	W22ESR-U	-
94701-00113	IW24	-
94701-00116	W20EPR-U	W20TT
94701-00117	W22EPR-U	W22TT
94701-00118	W24EPR-U	-
94701-00148	IWF24	-
94701-00157	X24ESR-U	-
94701-00159	W14FPR-UL	-
94701-00160	W24FSR-U10	-
94701-00168	W16FPR-U	-
9470100188	W27ESR-U	-
94701-00188-00	W27ESR-U	-
94701-00189	X22ESR-U	-
94701-00190	W16FPR-U	-
94701-00193	IW27	-
94701-00194	W16FPR-U	-
94701-00195	W24FSR	-
94701-00198	W20FPR-U	WF20TT
94701-00203	X24ESR-U	-
94701-00204	W24ESR-U	-
94701-00208	X22ESR-U	-
94701-00218	W22EPR-U	W22TT
94701-00219	W24EPR-U	-
94701-00220	W22FPR-U	-
94701-00222	X24ESR-U	-
94701-00227	W22FPR-U	-
94701-00232	W20FPR-U	WF20TT
94701-00234	W20EPR-U	W20TT
9470100237	W24FPR-U10	-
94701-00241	X24EPR-U9	-
94701-00248	W20FSR-U	WF20TT
94701-00250	U22FSR-U	-
94701-00251	W27FSR	-
94701-00254	U22FSR-U	-
94701-00256	U20FSR-U	-
94701-00258	W14FPR-UL	-
94701-00262	X22EPR-U9	-
94701-00263	X22EPR-U9	-
94701-00264	W22FP-U10	-
94701-00265	U22FSR-U	-
94701-00266	X27ESR-U	-
94701-00267	W24EPR-U	-
94701-00268	W24FP-U	-

YAMAHA	DENSO	TT
94701-00273	W20FSR-U	WF20TT
94701-00274	W20FSR-U	WF20TT
94701-00275	X24EPR-U9	-
94701-00280	W24FPR	-
94701-00282	U20FSR-U	-
94701-00283	U20FSR-U	-
94701-00284	IW20	IW20TT
94701-00285	IW20	IW20TT
94701-00287	X27ESR-U	-
94701-00292	W20FPR-U10	WF20TT
94701-00300	U16FSR-U	-
94701-00301	IW20	IW20TT
94701-00311	W16ESR-U	-
94701-00318	U27ESR-N	-
94701-00328	W16EPR-U	W16TT
94701-00329	U24ESR-N	-
94701-00330	U24ESR-N	-
94701-00332	IWM01-32	-
94701-00333	X24ESR-U	-
94701-00340	X27ESR-U	-
94701-00345	X22ESR-U	-
94701-00353	U22ESR-N	-
94701-00354	U14FSR-UB	-
94701-00361	X27EPR-U9	-
94701-00365	T20R-U	-
94701-00366	U22FSR-U	-
94701-00372	U20FSR-U	-
94701-00375	X20EPR-U9	-
94701-00381	U20ESR-N	-
94701-00386	U31ETR	-
94701-00394	IU01-31	-
94701-00395	U27ETR	-
9470100403	U27ETR	-
94701-00403-00	U27ETR	-
94701-00407	IU27D	-
94701-00408	IU27D	-
94701-00410	U27ESR-N	-
94701-00411	U24ESR-N	-
94701-00840	U22ESR-N	-
94702-00044	W22ESR-U	-
94702-00045	W24ESR-U	-
94702-00046	W27ESR-U	-
94702-00149	W22FS-U	-
94702-00188	W27ESR-U	-
94702-00193	IW27	-
94702-00195	W24FSR	-
94702-00204	W24ESR-U	-
94702-00211	W20MPR-U10	-
9470200234	W20EPR-U	W20TT
94702-00247	W24FSR-U10	-
94702-00249	W16FSR	-
94702-00271	W22FSR	-
94702-00272	W22FSR	-
94702-00274	W20FSR-U	WF20TT
94702-00309	W27FSR-U10	-
94702-00317	W27FSR-U10	-
94702-00323	W24ES-V	-
94702-00324	W27ESR-V	-
94702-00325	W27ES-V	-
94702-00326	W24ESR-V	-
94702-00331	W14EPR-U	IW16TT
94702-00343	W14E	-
94702-00348	W9EXR-U+CU	-
94702-00349	W22ESR-U	-
94702-00357	W27EMR-C	-
94702-00367	IW31	-
94702-00368	IW31	-
94702-00372	U20FSR-U	-
94702-00373	IW31	-
94702-00374	IWM01-32	-
94702-00391	K16HPR-U11	KH16TT

YAMAHA	DENSO	TT
94702-00427	K20HR-U11	KH20TT
94702-00429	XU22HDR9	XUH22TT
94702-00801	X24ESR-U	-
94702-00N01	W16FPR-U	-
94703-00001	W14F-U	-
94703-00039	W20FSR-U	WF20TT
94703-00040	W22FS-U	-
94703-00041	W24FSR	-
94703-00043	W20ESR-U	-
94703-00044	W22ESR-U	-
94703-00045	W24ESR-U	-
94703-00046	W27ESR-U	-
94703-00050	W22FPR-U	-
94703-00069	W16FSR	-
94703-00078	W16ESR-U	-
94703-00108	W20FPR-U	WF20TT
94703-00110	W22FSR	-
94703-00112	W22ESR-U	-
94703-00114	IW27	-
94703-00116	W20EPR-U	W20TT
94703-00117	W22EPR-U	W22TT
94703-00133	W16EPR-U	W16TT
94703-00157	X24ESR-U	-
94703-00159	W14FPR-UL	-
94703-00160	W24FSR-U10	-
94703-00168	W16FPR-U	-
94703-00181	X24ESR-U	-
94703-00188	W27ESR-U	-
94703-00189	X22ESR-U	-
94703-00194	W16FPR-U	-
94703-00198	W20FPR-U	WF20TT
94703-00203	X24ESR-U	-
94703-00204	W24ESR-U	-
94703-00207	W14E	-
94703-00213	U20FSR-U	-
94703-00215	U22FSR-U	-
94703-00217	W22FS-U	-
94703-00218	W22EPR-U	W22TT
94703-00220	W22EPR-U	W22TT
94703-00222	X24ESR-U	-
94703-00223	W20FPR-U	WF20TT
94703-00227	W22FPR-U	-
94703-00232	W20FPR-U10	WF20TT
94703-00234	W20EPR-U	W20TT
94703-00235	W20FPR-U	WF20TT
94703-00241	X24EPR-U9	-
94703-00254	U22FSR-U	-
94703-00256	U20FSR-U	-
94703-00258	W14FPR-UL	-
94703-00262	X22EPR-U9	-
94703-00263	X22EPR-U9	-
94703-00264	W22FP-U10	-
94703-00267	W24EPR-U	-
94703-00275	X24EPR-U9	-
94703-00277	IW27	-
94703-00283	U20FSR-U	-
94703-00307	U27ES-N	-
94703-00314	U24ES-N	-
94703-00315	U27ES-N	-
94703-00318	U27ESR-N	-
94703-00319	U27ESR-N	-
94703-00320	W22EPR-U11	W22TT
94703-00323	W24ES-V	-
94703-00325	W27ES-V	-
94703-00327	W22FPR-U	-
94703-00329	U24ESR-N	-
94703-00330	U24ESR-N	-
94703-00332	IWM01-32	-
94703-00333	X24ESR-U	-
94703-00345	X22ESR-U	-
94703-00352	U22ESR-N	-

Spark & Glow Plugs

Cross Reference Chart - OE

YAMAHA	DENSO	TT
94703-00353	U22ESR-N	-
94703-00355	W22FSR	-
94703-00366	U22FSR-U	-
94703-00367	IW31	-
94703-00372	U20FSR-U	-
94709-00195	W24FSR	-
94709-00247	W24FSR-U10	-
94709-00324	W27ESR-V	-
94709-00357	W27EMR-C	-
94709-00372	U20FSR-U	-
94709-00383	W27ESR-V	-
94709-00384	W31ESR-U	-
94709-00391	K16HPR-U11	KH16TT
94709-00400	K20HR-U11	KH20TT
94709-00N01	W16FPR-U	-
IQG-10862-20	XU22EPR-U	XU22TT
LKR-6E000-00-00	XU20HR9	-
NGKBR10EG000	IW31	-
Q1Q-DNS-021-000	IXU22	-
Q1Q-DNS-022-000	IXU24	-
Q1Q-DNS-026-000	IQ22	-

YANASE	DENSO	TT
51050K16	IK16	IK16TT
51050K20	IK20	IK20TT
51050K22	IK22	-
51050Q16	IQ16	IQ16TT
51050Q20	IQ20	IQ20TT
51050Q22	IQ22	-
51050T16	IT16	IT16TT
51050T20	IT20	IT20TT
51050T22	IT22	-
51050W16	IW16	IW16TT
51050W20	IW20	IW20TT
51050W22	IW22	-
5105TF16	ITF16	ITF16TT
5105TF20	ITF20	ITF20TT
5105TV16	ITV16	ITV16TT
5105TV20	ITV20	ITV20TT
5105VK16	VK16	IK16TT
5105VK20	VK20	IK20TT
5105VK22	VK22	-
5105VKH200	VKH20	IKH20TT
5105VQ16	VQ16	IQ16TT
5105VQ20	VQ20	IQ20TT
5105VQ22	VQ22	-
5105VT16	VT16	IT16TT
5105VW16	VW16	IW16TT
5105VW20	VW20	IW20TT
5105VW22	VW22	-
5105VXU220	VXU22	-
5105WF22	IWF22	-
5105XU22	IXU22	-

Spark & Glow Plugs

Cross Reference Chart - Competitor

ACCEL	DENSO	TT
111	IW27	-
112	W24EPR-U	-
113	W22EPR-U	W22TT
114	W20EX-U	W20TT
115	W20EP-U	W20TT
116	W16EXR-U	W16TT
117	W14EX-U	IW16TT
123	W22S-U	-
124	W20S-U	-
134	W20PR-U	-
137	W16PR-U	-
138	W9PR-U	-
141	W27ESR-U	-
142	W24ESR-U	-
143	W22ESR-U	-
146	W16ESR-U	-
166	W16LS	-
168	W14L	-
194	W20EXR-U11	W20TT
198	W9PR-U	-
2401P	W9PR-U	-
2403P	W16EXR-U	W16TT
2407P	W24ESR-U	-
2412P	W22EPR-U	W22TT
2413P	W22FPR-U	-
2417P	J16BR-U	-
262	ITF27	-
263	ITF24	-
272	IT27	-
274	T20PR-U	ITF20TT
276	T16PR-U	ITF16TT
276S	T20MP-U	-
286	T16PR-U15	ITF16TT
375	MA20P-U	-
378	MA16PR-U	-
416	Q16PR-U	Q16TT
437	W16PR-U	-
437S	W16PR-U	-
453	W22FPR-U	-
494	W20EXR-U	W20TT
496	W16EXR-U	W16TT
498	W9PR-U	-
504	T20NR-U11	IT20TT
506	T16NR-U11	IT16TT
514	T20EPR-U	T20TT
516	T16EPR-U	T16TT
524	T20EPR-U15	T20TT
526	T16EPR-U15	T16TT
566	T16R-U	IT16TT
574	T20PR-U	ITF20TT
576	T16PR-U	ITF16TT
577	T14PR-U	ITF16TT
586	T16PR-U15	ITF16TT
596	T16PR-U15	ITF16TT
675	MA20PR-U	-
736	KJ16CR-U11	K16TT
761	IK31	-
762	IK27	-
763	K24PR-U11	-
765	K22PR-U	-
784	K20PR-U	K20TT
786	K16PR-U	K16TT
842	X24ESR-U	-
882	X24EPR-U9	-
997	J16BR-U	-
ACC7ES	W22ESR-U	-
ACC7HS	W22FS-U	-
ACC8ES	W24ESR-U	-
ACC8HS	W24FSR	-
ACC9ES	W27ESR-U	-
ACCR7ES	W22ESR-U	-

ACCEL	DENSO	TT
ACCR8ES	W24ESR-U	-
ACCR8HS	W24FSR	-
ACCR9ES	W27ESR-U	-
P411	IW27	-
P437	W16PR-U	-
P496	W16EXR-U	W16TT
P524S	IT20	IT20TT
P526S	PT16EPR-L13	IT16TT
P562	IT27	-
P563	IT24	-
P566	T16R-U	IT16TT
P574	T20PR-U	ITF20TT
P576	T16PR-U	ITF16TT
P678	MA16PR-U	-
P962	IT27	-

ACDelco	DENSO	TT
I2	IT16	IT16TT
I21XLS	X24EPR-U9	-
40TS	ITF22	-
41	W27S-U	-
41101	VT16	IT16TT
41103	ITL16	ITL16TT
41104	VT20	IT20TT
41105	ITL16	ITL16TT
41108	ITV16	ITV16TT
41109	ITV20	ITV20TT
41600	T16EPR-U15	T16TT
41601	T16EPR-U15	T16TT
41602	K20PR-U	K20TT
41603	K16PR-U	K16TT
41606	T16EPR-U15	T16TT
41608	K16PR-U11	K16TT
41610	K16PR-U	K16TT
41611	K16PR-U11	K16TT
41627	K16PR-U11	K16TT
41628	K16PR-U	K16TT
41629	K16PR-U	K16TT
41801	K20PR-U11	K20TT
41806	KJ16CR-L11	K16TT
41810	T20EPR-U	T20TT
41814	PT16VR13	TV16TT
41900	PT16EPR-L13	IT16TT
41902	PT16EPR-L13	IT16TT
41904	PT16EPR-L13	IT16TT
41905	ITF16	ITF16TT
41906	PT16EPR-L13	IT16TT
41907	PT16EPR-L13	IT16TT
41908	PT16EPR-L13	IT16TT
41910	PT16EPR-L13	IT16TT
41913	PT16EPR-L13	IT16TT
41919	PT16EPR-L13	IT16TT
41921	PT16EPR-L13	IT16TT
41928	PT16EPR-L13	IT16TT
41929	PT16EPR-L13	IT16TT
41931	PT16EPR-L13	IT16TT
41932	PT16EPR-L13	IT16TT
41933	PT16EPR-L13	IT16TT
41936	PT16EPR-L13	IT16TT
41937	PT16EPR-L13	IT16TT
41940	PT16EPR-L13	IT16TT
41942	PT16EPR-L13	IT16TT
41943	PT16EPR-L13	IT16TT
41947	PT16EPR-L13	IT16TT
41948	PT16EPR-L13	IT16TT
41950	PT16EPR-L13	IT16TT
41952	PT16EPR-L13	IT16TT
41954	ITV20	ITV20TT
41963	PT16EPR-L13	IT16TT
41965	ITV16	ITV16TT
41974	PTJ16R15	IT16TT

ACDelco	DENSO	TT
41975	PT16EPR-L13	IT16TT
41981	ITV16	ITV16TT
41983	IT16	IT16TT
41985	IT16	IT16TT
41986	PT16EPR-L13	IT16TT
41987	PT16EPR-L13	IT16TT
41990	PT16VR13	TV16TT
41993	PT16EPR-L13	IT16TT
41F	W27FSR	-
41TS	ITF22	-
41XL	W27ESR-U	-
41XLS	W24EPR-U	-
426FS	W22FPR-U	-
42F	W22FS-U	-
42FS	W22FPR-U	-
42LTS	T20EPR-U	T20TT
42S	W20PR-U	-
42TS	T20PR-U	ITF20TT
42XL	W22ESR-U	-
42XLS	W22EPR-U	W22TT
43	W20S-U	-
438XLS	W24EPR-U	-
43F	W20FSR-U	WF20TT
43FS	W20FPR-U	WF20TT
43LS	W16LS	-
43N	W20ESR-U	-
43S	W20PR-U	-
43TS	T20PR-U	ITF20TT
43XL	W20ESR-U	-
43XLS	W20EP-U	W20TT
44	W16S-U	-
44F	W16FSR	-
44FFS	W16FPR-U	-
44FS	W16FPR-U	-
44N	W20ESR-U	-
44NS	W16EPR-U	W16TT
44S	W16PR-U	-
44TS	T16PR-U	ITF16TT
44XL	W20ESR-U	-
44XLS	W16EPR-U	W16TT
45	W14PR-U	-
45F	W16FSR	-
45FFS	W14FPR-U	-
45L	W14L	-
45LS	W14L	-
45NS	W14EX-U	IW16TT
45S	W14PR-U	-
45TS	T16PR-U	ITF16TT
45XL	W16ESR-U	-
45XLS	W14EX-U	IW16TT
46	W9-U	-
46F	W14F-U	-
46N	W16ESR-U	-
46S	W9PR-U	-
46TS	T14PR-U	ITF16TT
46XL	W16ESR-U	-
46XLS	W9EP	-
47XL	W14E	-
83CTS	MA20P-U	-
83TS	MA20P-U	-
84T	MA16PR-U	-
84TS	MA16PR-U	-
85T	MA16PR-U	-
85TS	MA16PR-U	-
86TS	MA9P-U	-
B43	W20S-U	-
C41CLTS	T22EP-U	-
C41CXL	W22EPR-U	W22TT
C421	W24S-U	-
C42CFS	W22FPR-U	-
C42CLTS	T20EPR-U	T20TT

ACDelco	DENSO	TT
C42CXLS	W20EP-U	W20TT
C42N	W22ESR-U	-
C42XLS	W20EP-U	W20TT
C43	W20S-U	-
C43CXLS	W16EPR-U	W16TT
C43L	W16LS	-
C43N	W20ESR-U	-
C44	W16S-U	-
C44N	W20ESR-U	-
C44NS	W16EXR-U	W16TT
C44S	W16PR-U	-
C45	W14PR-U	-
C45L	W14L	-
C47W	W9-U	-
C49	W9-U	-
C81	M22	-
C82	M22	-
C82T	MA20P-U	-
C83	M17	-
C83T	MA20PR-U	-
C84T	MA16PR-U	-
C84TS	MA16PR-U	-
C85	L14-U	-
C85S	L14-U	-
C85T	MA16PR-U	-
C85TS	MA16PR-U	-
C86	L14-U	-
C86S	L14-U	-
C87	L14-U	-
C88	L14-U	-
C88L	L14-U	-
CFR1CLS	K22PR-U	-
CFR2CLS	K20PR-U	K20TT
CFR3CLS	K16PR-U	K16TT
CR41CXLS	W22EPR-U	W22TT
CR425FS	W20FPR-U	WF20TT
CR425XLS	W16EPR-U	W16TT
CR42CLTS	T20EPR-U	T20TT
CR42CTS	T20PR-U	ITF20TT
CR42N	W22ESR-U	-
CR42TS	T20PR-U	ITF20TT
CR42XLS	W20EPR-U	W20TT
CR42XLSX	W20EPR-U11	W20TT
CR43	W20SR-U	-
CR43CXLS	W16EPR-U	W16TT
CR43N	W20ESR-U	-
CR43S	W20PR-U	-
CR43TS	T20PR-U	ITF20TT
CR43TSM	T20PR-U	ITF20TT
CR44N	W20ESR-U	-
CR44NS	W16EPR-U	W16TT
CR44TS	T16PR-U	ITF16TT
CR45L	W14L	-
CR45TS	T16PR-U	ITF16TT
CS41	W22M-U	-
CS42	W22M-U	-
CS42S	W22MPR-U	-
CS42T	T22M-U	-
CS45	W20MR-U	-
CS45T	T20M-U	-
CSR45	W20PR-U	-
FR1LS	K20PR-U11	K20TT
FR2LS	K20PR-U11	K20TT
FR3CLS	K16PR-U11	K16TT
FR3CLS6	Q16PR-U11	Q16TT
FR3LM	QJ16HR-U9	-
FR3LS	K16R-U11	K16TT
FR3LS6	K16PR-U11	K16TT
FR3LSK	K16PR-U11	K16TT
FR4LE	QJ16HR-U9	-
FR5LM	QJ16HR-U9	-

Spark & Glow Plugs

Cross Reference Chart - Competitor

ACDelco	DENSO	TT
FR5LS	K16PR-U11	K16TT
HE2	ITV20	ITV20TT
LM46	W14LM-U	-
LM49	W14LM-U	-
M40FFX	W27FSR-U10	-
M41FF	W24FSR	-
M41FFG	IWF27	-
M41K	W22S-U	-
M42FF	W22FS-U	-
M43FF	W20FSR-U	WF20TT
M43S	W20PR-U	-
M44C	W16S-U	-
M44L	W14L	-
M45	W14PR-U	-
M45FF	W16FSR	-
M47	W9-U	-
MR41T	ITF22	-
MR42LTS	T20EPR-U	T20TT
MR43LTS	T20EPR-U	T20TT
MR43T	T20R-U	-
MR441	T16R-U	IT16TT
MR44C	W20SR-U	-
MR44T	T16R-U	IT16TT
R121CXLS	X24EPR-U9	-
R121XLS	X24EPR-U9	-
R41CF	W24FSR	-
R41CXL	W27ESR-U	-
R41F	W24FSR	-
R41XL	W27ESR-U	-
R42CF	W22FSR	-
R42CFS	W22FPR-U	-
R42CLTS	T20EPR-U	T20TT
R42CLTS6	T20EPR-U15	T20TT
R42CT	T20R-U	-
R42CTS	T20PR-U	ITF20TT
R42CXL	W22ESR-U	-
R42CXLS	W22EPR-U	W22TT
R42F	W22FSR	-
R42FS	W22FPR-U	-
R42LTS	T20EPR-U	T20TT
R42LTS6	T20EPR-U15	T20TT
R42LTSM	T20EPR-U	T20TT
R42NS	W22EPR-U	W22TT
R42S	W20PR-U	-
R42T	T20R-U	-
R42TS	T20PR-U	ITF20TT
R42TSM	T20PR-U	ITF20TT
R42TX	T20R-U	-
R42XL	W22ESR-U	-
R42XLS	W22EPR-U	W22TT
R42XLS6	W22EPR-U11	W22TT
R42XLSM	W22EPR-U	W22TT
R43	W20SR-U	-
R43C	W20SR-U	-
R43CFS	W20FPR-U	WF20TT
R43CS	W20PR-U	-
R43CT6	T20R-U	-
R43CTS	T20PR-U	ITF20TT
R43CTS6	T20PR-U15	ITF20TT
R43CXL	W20ESR-U	-
R43CXLS	W20EXR-U	W20TT
R43FS	W20FPR-U	WF20TT
R43LTS	T20EPR-U	T20TT
R43LTS6	T20EPR-U15	T20TT
R43LTSE	T20EPR-U	T20TT
R43LTSX	T20EPR-U15	T20TT
R43N	W20ESR-U	-
R43NS	W20EPR-U	W20TT
R43NTS6	T20EPR-U15	T20TT
R43NTSE	T20NR-U11	IT20TT
R43S	W20PR-U	-

ACDelco	DENSO	TT
R43T	T20R-U	-
R43TS	T20PR-U	ITF20TT
R43TS6	T20PR-U15	ITF20TT
R43TSK	T20PR-U	ITF20TT
R43TSX	T20PR-U15	ITF20TT
R43TX	T20R-U	-
R43XL	W20ESR-U	-
R43XLS	W20EXR-U	W20TT
R44CF	W16FSR	-
R44CXL	W20ESR-U	-
R44CXLS	W16EPR-U	W16TT
R44F	W16FSR	-
R44LT	W16EPR-U	W16TT
R44LTS	T16EPR-U	T16TT
R44LTS6	T16EPR-U15	T16TT
R44LTS6K	T16EPR-U15	T16TT
R44LTSM	T16EPR-U	T16TT
R44LTSM6	T16EPR-U15	T16TT
R44LTSMA	T16EPR-U	T16TT
R44N	W16ESR-U	-
R44NS	W16EXR-U	W16TT
R44NSX	W16EPR-U11	W16TT
R44NTSE	T16NR-U11	IT16TT
R44S	W16PR-U	-
R44SX	W16PR-U	-
R44T	T16R-U	IT16TT
R44TS	T16PR-U	ITF16TT
R44TS8	T16PR-U15	ITF16TT
R44TSX	T16PR-U15	ITF16TT
R44TX	T16R-U	IT16TT
R44XL	W20ESR-U	-
R44XLS	W16EPR-U	W16TT
R44XLS6	W16EXR-U11	W16TT
R44XLSE	KJ16CR-L11	K16TT
R44XLSM	J16BR-U	-
R45NS	W14EXR-U	IW16TT
R45NSX	W14EXR-U11	IW16TT
R45NTSE	T16NR-U11	IT16TT
R45S	W14PR-U	-
R45SX	W14PR-U	-
R45T	T16R-U	IT16TT
R45TS	T16PR-U	ITF16TT
R45TS8	T16PR-U15	ITF16TT
R45TSX	T16PR-U15	ITF16TT
R45XL	W16ESR-U	-
R45XLS	W14EXR-U	IW16TT
R45XLS6	W14EXR-U11	IW16TT
R46LTS	T16EPR-U	T16TT
R46S	W9PR-U	-
R46SX	W9PR-U	-
R46SZ	W9PR-U	-
R46T	T16R-U	IT16TT
R46TS	T14PR-U	ITF16TT
R46TSX	T14PR-U	ITF16TT
R46TX	T16R-U	IT16TT
R47S	W9PR-U	-
R47SX	W9PR-U	-
R83CTS	MA20PR-U	-
R83TS	MA20PR-U	-
R84TS	MA16PR-U	-
R84TSX	MA16PR-U	-
R85T	MA16PR-U	-
R85TS	MA16PR-U	-
R86T	MA16PR-U	-
R86TS5	MA16PR-U	-
RF#1	T20PR-U	ITF20TT
RF#2	T16PR-U	ITF16TT
RF#4	W20EXR-U	W20TT
RF#5	Q16PR-U11	Q16TT
S102F	U22FSR-U	-
S104F	U20FSR-U	-

ACDelco	DENSO	TT
S121XL	X24ESR-U	-
S122F	X24FS-U	-
S123XL	X22ESR-U	-
S124FS	X20FSR-U	-
S404XLG	IW01-27	-
S40F	W27FSR	-
S40FR	W27FSR	-
S40XL	W27ESR-U	-
S40XLG	IW31	-
S40XLR	W27ESR-U	-
S412FR	W24FSR	-
S41F	W24FSR	-
S41FG	IWF27	-
S41FR	W24FSR	-
S41SLG	IW01-27	-
S41XL	W27ESR-U	-
S41XLR	W27ESR-U	-
S42	W24S-U	-
S42F	W22FS-U	-
S42FR	W22FSR	-
S42XL	W22ESR-U	-
S42XLR	W22ESR-U	-
S43XL	W20ESR-U	-
S43XLR	W20ESR-U	-
S44	W16S-U	-
S44F	W16FSR	-
S44XL	W20ESR-U	-
S45F	W16FSR	-
S46	W9-U	-
S81F	M22	-
S82F	M22	-
S83F	M17	-
S85F	L14-U	-
SV4XL	SF-50	-
V40FFK	SF-51	-
V40FFM	SF-50	-
V40FFS	SF-50	-
VB40FFK	SF-50	-
VR40FFM	SF-50	-

ALTRONIC	DENSO	TT
J1443DP	GN3-1A	-
J1463DP	GE3-1	-
L1843B	GT3-1	-
L1843IP	GT3-1	-
L1863B	GI3-1	-
L1863DP	GI3-1	-
L1863IP	GI3-1	-

APEX	DENSO	TT
06	IQ20	IQ20TT
06STD	IK20	IK20TT
07	IQ22	-
07STD	IK22	-
08	IQ24	-
08STD	IK24	-
09	IQ27	-
09STD	IK27	-

BERU	DENSO	TT
0001245702	X22EPR-U9	-
0001325701	W14EPR-U	IW16TT
0001325704	W14EPR-U	IW16TT
0001325705	K16PR-U11	K16TT
0001325710	W16EPB10	W16TT
0001330104	W20EPBR-S	W20TT
0001330112	W20EPBR-S	W20TT
0001330113	W20EPBR-S	W20TT
0001330116	K20PBR-S10	K20TT
0001330117	K20PBR-S10	K20TT
0001330501	K20TXR	K20TT

BERU	DENSO	TT
0001330702	W16EPR-U	W16TT
0001330707	K16PR-U11	K16TT
0001330709	W16EPB10	W16TT
0001330713	W16EPR-U	W16TT
0001330717	KJ16CR11	K16TT
0001330718	J16CR-U	W16TT
0001330725	K16PR-U11	K16TT
0001330726	W16EPR-U	W16TT
0001330731	K16PR-U11	K16TT
0001330780	K20PR-U	K20TT
0001330904	PK16PR-L11	IK16TT
0001330905	SK16PR-L11	IK16TT
0001335107	K20PBR-S10	K20TT
0001335108	W20EPBR-S	W20TT
0001335110	K20PBR-S10	K20TT
0001335702	W20EPR-U	W20TT
0001335707	W20ESR-U	-
0001335709	W20EPB	W20TT
0001335714	W20EP-U	W20TT
0001335721	K20P-U	K20TT
0001335725	K20P-U	K20TT
0001335729	K20P-U	K20TT
0001335732	K20TXR	K20TT
0001335737	W20EP-U	W20TT
0001335742	KJ16CR-L11	K16TT
0001335905	SK20PR-L9	IK20TT
0001335910	PK20PR-P8	IK20TT
0001335911	PKJ16CR-L11	IK16TT
0001335914	PK20PR-P8	IK20TT
0001335917	VK20	IK20TT
0001340103	K20PBR-S10	K20TT
0001340702	W20EPR-U	W20TT
0001340704	W20EPB	W20TT
0001340706	K20PBR	K20TT
0001340707	W20EPR-U	W20TT
0001340716	K20P-U	K20TT
0001340717	K20PBR	K20TT
0001340723	K20P-U	K20TT
0001340806	IK20	IK20TT
0001340903	IW20	IW20TT
0001340908	VK22	-
0001340915	VKB20	-
0001340916	VK20	IK20TT
0001345702	W22EPR-U	W22TT
0001345704	W22EPB	W22TT
0001345711	W22EPR-U	W22TT
0001345720	K22PR-U	-
0001345906	IKH22	-
0001345914	PK22PR8	-
0001350903	IW24	-
0001350910	VKH22	-
0001355700	W27ESR-U	-
0001400701	W20FSR-U	WF20TT
0001430700	W16FPR-U	-
0001430701	W16FSR	-
0001435700	W20FPR-U	WF20TT
0001435705	W20FSR-U	WF20TT
0001440700	W20FPR-U	WF20TT
0001445700	W22FPR-U	-
0001445702	W22FS-U	-
0001450702	W24FSR	-
0001529302	W16S-U	-
0001625700	T16EPR-U	T16TT
0001625702	T16EPR-U	T16TT
0001630700	T16EPR-U	T16TT
0001630704	T16EPR-U	T16TT
0001635700	T20EPR-U	T20TT
0001635709	T20EPR-U	T20TT
0001640700	T20EPR-U	T20TT
0001640705	T20EPR-U	T20TT
0001645700	T22EP-U	-

Spark & Glow Plugs

Cross Reference Chart - Competitor

BERU	DENSO	TT
0001735700	MA20P-U	-
0001835700	M17	-
0002140900	IJ22	-
0002230300	XE20HR-U9	IXEH20TT
0002235700	XJ22PR9	XJ22TT
0002235901	VXUH22	-
0002235905	FXE20HR11	IXEH20TT
0002240701	XJ22EPR-U	XJ22TT
0002240702	XJ22EPR-U	XJ22TT
0002240703	XJ22HDR9	XUH22TT
0002240902	VXUH22	-
0002240907	VXUH22	-
0002240909	VXUH22	-
0002240911	IXUH22	-
0002245704	XJ24EPR-U	-
0002325700	W16EPR-U	W16TT
0002325723	KJ16CR-L11	K16TT
0002325900	P16R13	W20TT
0002330102	K20TXR	K20TT
0002330104	K20PBR	K20TT
0002330203	QJ16AR-U	-
0002330204	K16R-U11	K16TT
0002330206	K16PR-U	K16TT
0002330215	KJ16CR-L11	K16TT
0002330701	W16EPR-U	W16TT
0002330702	W16EPR-U11	W16TT
0002330703	K16PR-U	K16TT
0002330704	K16PR-U11	K16TT
0002330706	W20EPR-U	W20TT
0002330709	W16EPR-U	W16TT
0002330710	K20TXR	K20TT
0002330712	KJ16CR-L11	K16TT
0002330713	K16R-U	K16TT
0002330714	K16R-U	K16TT
0002330716	K16HPR-U11	KH16TT
0002330794	KJ16CR-L11	K16TT
0002330795	K16TR11	K16TT
0002330902	IKH16	IKH16TT
0002330918	VKB16	-
0002330926	IKH16	IKH16TT
0002330930	PK16PR-L11	IK16TT
0002335100	K20PBR-S10	K20TT
0002335104	K20PBR-S10	K20TT
0002335128	K20TXR	K20TT
0002335131	K20PBR-S10	K20TT
0002335137	K20PBR-S10	K20TT
0002335138	K16TNR-S9	K16TT
0002335139	K20BR-S10	K20TT
0002335500	K20TNR	K20TT
0002335503	K20TXR	K20TT
0002335701	W20EPR-U	W20TT
0002335706	W20EPR-U11	W20TT
0002335707	K20PR-U	K20TT
0002335708	K20PR-U11	K20TT
0002335709	K20TXR	K20TT
0002335712	K20R-U	K20TT
0002335713	K20R-U	K20TT
0002335714	K20R-U11	K20TT
0002335715	KJ20CR-L11	K20TT
0002335717	K20PR-U	K20TT
0002335719	K20HR-U11	KH20TT
0002335802	KJ20DR-M11	IK20TT
0002335901	IK20	IK20TT
0002335902	PK20R11	K20TT
0002335903	PQ20R	Q20TT
0002335904	PK20R8	IK20TT
0002335908	PK20PR-P8	IK20TT
0002335911	K20TXR	K20TT
0002335912	K20TXR	K20TT
0002335914	PK20PR-L11	IK20TT
0002335915	IKH20	IKH20TT

BERU	DENSO	TT
0002335925	VKB20	-
0002335926	SK20R11	IK20TT
0002335935	VK20	IK20TT
0002335937	SK16PR-E11	IK16TT
0002335939	IKH22	-
0002335940	PK20PR-P8	IK20TT
0002335946	PK20PR-P8	IK20TT
0002335947	IK20L	IK20TT
0002336715	KJ20CR-L11	K20TT
0002336724	K20PR-U	K20TT
0002336738	K20HR-U11	KH20TT
0002340101	K20PBR-S10	K20TT
0002340102	K20TXR	K20TT
0002340117	K20PBR-S10	K20TT
0002340123	K20PBR-S10	K20TT
0002340500	K22TNR-S	-
0002340501	K22TNR-S	-
0002340701	W20EPR-U	W20TT
0002340702	K20PR-U	K20TT
0002340703	W20EPR-U11	W20TT
0002340704	Q20PR-U11	Q20TT
0002340903	VK20	IK20TT
0002340905	PK20PR-L11	IK20TT
0002340906	VKH20	IKH20TT
0002340908	PK20PR-L11	IK20TT
0002340910	PK20PR-P8	IK20TT
0002340915	VW20	IW20TT
0002345118	IKH22	-
0002345501	K20TXR	K20TT
0002345701	W22EPR-U	W22TT
0002345702	K22PR-U	-
0002345704	K22PBR-S	-
0002345906	SKJ20DR-M11	IK20TT
0002435701	W20FPR-U	WF20TT
0002620708	ITL16	ITL16TT
0002625700	T16EPR-U	T16TT
0002630701	PT16VR13	TV16TT
0002630715	PT16VR13	TV16TT
0002630900	PT16EPR-L13	IT16TT
0002630905	ITV20	ITV20TT
0002635100	T20EPR-U	T20TT
0002635700	T20EPR-U	T20TT
0002635701	T20EPR-U	T20TT
0002635902	ZT20EPR11	T20TT
0002635903	PT16VR13	TV16TT
0002635904	ITV16	ITV16TT
0002640100	T20EPR-U	T20TT
0002640700	T20EPR-U	T20TT
0002640701	T20PR-U	TF20TT
0002640900	PT16VR10	TV16TT
0002640904	ZT20EPR11	T20TT
0002640910	ITV24	-
0004350900	GE3-1	-
0004350904	GE5-1	-
0004350905	GK3-1A	-
0004350908	GE5-1	-
0004350911	GK3-1A	-
0004355900	GE3-1	-
0004355902	GE3-1	-
0004445901	GN3-1A	-
0004450900	GN3-1A	-
0004535300	W20MR-U	-
0004545401	W22MPR-U	-
0004800501	GI3-1	-
0004800503	GI3-1	-
0004800906	GL3-1	-
0004800907	GI3-1	-
0004800912	GI3-1	-
0004800918	GL3-1	-
0004800919	GI3-1	-
0100220103	DG-012	-

BERU	DENSO	TT
0100220118	DG-157	-
0100221102	DG-001	-
0100221103	DG-001	-
0100221105	DG-012	-
0100221106	DG-001	-
0100221107	DG-001	-
0100221108	DG-012	-
0100221132	DG-123	-
0100221133	DG-001	-
0100221135	DG-001	-
0100221141	DG-202	-
0100221144	DG-004	-
0100221145	DG-001	-
0100221146	DG-004	-
0100221147	DG-198	-
0100221148	DG-234	-
0100221151	DG-221	-
0100221152	DG-012	-
0100221153	DG-001	-
0100221154	DG-114	-
0100221163	DG-001	-
0100221164	DG-001	-
0100221167	DG-001	-
0100221170	DG-132	-
0100221186	DG-143	-
0100222101	DG-215	-
0100222102	DG-159	-
0100222105	DG-213	-
0100222106	DG-189	-
0100226128	DG-001	-
0100226129	DG-115	-
0100226138	DG-121	-
0100226163	DG-006	-
0100226164	DG-012	-
0100226170	DG-137	-
0100226171	DG-137	-
0100226173	DG-012	-
0100226180	DG-223	-
0100226182	DG-232	-
0100226183	DG-162	-
0100226184	DG-101	-
0100226185	DG-001	-
0100226186	DG-001	-
0100226188	DG-003	-
0100226189	DG-001	-
0100226194	DG-198	-
0100226198	DG-004	-
0100226203	DG-130	-
0100226206	DG-133	-
0100226207	DG-124	-
0100226208	DG-104	-
0100226209	DG-159	-
0100226227	DG-005	-
0100226229	DG-001	-
0100226233	DG-172	-
0100226234	DG-010	-
0100226235	DG-106	-
0100226237	DG-012	-
0100226238	DG-101	-
0100226242	DG-216	-
0100226243	DG-211	-
0100226245	DG-008	-
0100226246	DG-161	-
0100226248	DG-007	-
0100226249	DG-102	-
0100226250	DG-110	-
0100226255	DG-182	-
0100226258	DG-119	-
0100226284	DG-139	-
0100226299	DG-009	-
0100226300	DG-118	-

BERU	DENSO	TT
0100226301	DG-121	-
0100226312	DG-186	-
0100226336	DG-146	-
0100226338	DG-144	-
0100226343	DG-109	-
0100226344	DG-116	-
0100226351	DG-126	-
0100226352	DG-137	-
0100226353	DG-155	-
0100226354	DG-111	-
0100226362	DG-145	-
0100226365	DG-155	-
0100226366	DG-001	-
0100226368	DG-184	-
0100226371	DG-003	-
0100226372	DG-127	-
0100226373	DG-005	-
0100226375	DG-112	-
0100226379	DG-117	-
0100226381	DG-007	-
0100226383	DG-172	-
0100226384	DG-121	-
0100226385	DG-130	-
0100226391	DG-129	-
0100226392	DG-184	-
0100226417	DG-142	-
0100226422	DG-173	-
0100226435	DG-183	-
0100226436	DG-122	-
0100226462	DG-184	-
0100226473	DG-117	-
0100226475	DG-216	-
0100226480	DG-240	-
0100226482	DG-109	-
0100226492	DG-181	-
0100226493	DG-188	-
0100226494	DG-176	-
0100226495	DG-300	-
0100226496	DG-188	-
0100226497	DG-302	-
0100226511	DG-174	-
0100226513	DG-304	-
0100226514	DG-307	-
0100226517	DG-188	-
0100226520	DG-108	-
0100226522	DG-602	-
0100226525	DG-312	-
0100226526	DG-502	-
0100226527	DG-245	-
0100226538	DG-600	-
0100226568	DG-305	-
0100226569	DG-306	-
0100226570	DG-245	-
0100226639	DG-196	-
0100230107	DG-702	-
0100231107	DG-222	-
0100231114	DG-233	-
0100266001	DG-177	-
0100266002	DG-178	-
0100266003	DG-191	-
0100266005	DG-192	-
0100266007	DG-194	-
0100266008	DG-177	-
0100266009	DG-190	-
0100266010	DG-192	-
0100266011	DG-194	-
0100266014	DG-193	-
0100266020	DG-193	-
0100266024	DG-608	-
0100266031	DG-621	-

Spark & Glow Plugs

Cross Reference Chart - Competitor

BERU	DENSO	TT
0100266032	DG-609	-
0100266033	DG-619	-
0100266034	DG-608	-
0100266037	DG-607	-
0100266040	DG-193	-
0100266045	DG-194	-
0100266068	DG-603	-
0100266072	DG-610	-
0100266076	DG-604	-
0100271106	DG-175	-
0100276003	DG-195	-
0100276004	DG-113	-
0100276005	DG-140	-
0100276007	DG-171	-
0100276008	DG-171	-
0100276009	DG-606	-
0100276012	DG-180	-
0100276014	DG-606	-
0100276015	DG-170	-
0100276024	DG-614	-
0100800031	DG-197	-
0100800033	DG-187	-
0100800035	DG-605	-
0100800036	DG-601	-
0900102024	DG-001	-
0900102025	DG-123	-
0900102026	DG-001	-
0900102028	DG-001	-
0900102029	DG-012	-
0900102038	DG-001	-
0900102054	DG-004	-
10 FR-6 CPU03	IU22	-
105 MN	DG-001	-
12 FR 6 DU	XU22EPR-U	XU22TT
12 FR 7 DU	XU22PR9	XU22TT
12 FR-6 LUX	XU22EPR-U	XU22TT
12 FR-6 MUW	XU22HDR9	XU22TT
12 VR-8 SE	XE20HR-U9	IXEH20TT
12 ZR-6 SP02	VXUH22	-
12 ZR-6 SP03	VXUH22	-
12 ZR-6 SP2	VXUH22	-
12 ZR-7 SP03	VXUH22	-
12-5 DU	X22EPR-U9	-
12FR2CDU	X27ETR	-
12FR4CDU	IX24	-
12FR5DU	XU24EPR-U	-
12R5DU	X22EPR-U9	-
12VR7SPUX	FXE20HR11	IXEH20TT
12ZR6SPP2	VXUH22	-
12ZR6SPP21	IXUH22	-
14 7 CU	W20ESR-U	-
14 F-4 NBPR	VKH22	-
14 F-5 DPURS2	PK22PR8	-
14 F-6 DPUR021	VK22	-
14 F-6 DTPR02	VKB20	-
14 F-6 DTU	K20PBR	K20TT
14 F-6 DU0	K20P-U	K20TT
14 F-6 KPURW2	VK20	IK20TT
14 F-7 DU0	K20P-U	K20TT
14 F-7 HUR2	KJ16CR-L11	K16TT
14 F-7 HUR02	KJ20DR-M11	IK20TT
14 F-7 KPPRU2	VK20	IK20TT
14 F-7DU	K20P-U	K20TT
14 F-8 DU0	K16PR-U11	K16TT
14 F-8 DUR	K20PR-U	K20TT
14 F-8 LUR	KJ16CR11	K16TT
14 F-9 DU0	K16PR-U11	K16TT
14 FGH-7 DTRX0	K20PBR-S10	K20TT
14 FGH-8 DTUR	K20PBR-S10	K20TT
14 FGH-8 DTRX0	K20PBR-S10	K20TT
14 FGH-7 DTUT	K20PBR-S10	K20TT

BERU	DENSO	TT
14 FGHR-7 DTU	K20BR-S10	K20TT
14 FGHR-7 LDUW	K16TNR-S9	K16TT
14 FGR-5 NTE	IKH22	-
14 FGR-6 DDU	K20TXR	K20TT
14 FGR-6 HQU	K20PBR-S10	K20TT
14 FGR-6 KQU	K20PBR-S10	K20TT
14 FGR-7 CTU	K20PBR-S10	K20TT
14 FGR-7 KDU6	K20TXR	K20TT
14 FGR-7 KQE	K20PBR-S10	K20TT
14 FGR-7 KQU	K20PBR-S10	K20TT
14 FGR-8 CTU	K20PBR-S10	K20TT
14 FGR-8 MQPU	IKH16	IKH16TT
14 FR 8 DU	K16PR-U	K16TT
14 FR-5 LPU0X	SKJ20DR-M11	IK20TT
14 FR-6 DPOX	PK20PR-L11	IK20TT
14 FR-6 DPU02S	VW20	IW20TT
14 FR-6 DPUW2	PK20PR-P8	IK20TT
14 FR-7 DPPUS2	PK20PR-P8	IK20TT
14 FR-7 DPPUW2	PK20PR-P8	IK20TT
14 FR-7 DPUV02	SK16PR-E11	IK16TT
14 FR-7 DU2	K20PR-U	K20TT
14 FR-7 HUX	KJ20CR-L11	K20TT
14 FR-7 KPUV	PQ20R	Q20TT
14 FR-7 KPUX02	SK20R11	IK20TT
14 FR-7 KU0	K20R-U	K20TT
14 FR-7 LDU	K20TNR	K20TT
14 FR-7 LPU02	VKB20	-
14 FR-7 LPUT02	IK20L	IK20TT
14 FR-7 LPUX02	VK20	IK20TT
14 FR-7 LUX	KJ20CR-L11	K20TT
14 FR-7 LUX0	KJ20DR-M11	IK20TT
14 FR-7 MPUS	IKH22	-
14 FR-7 NUX2	K20HR-U11	KH20TT
14 FR-8 DPPUX	PK16PR-L11	IK16TT
14 FR-8 DUW	K16PR-U	K16TT
14 FR-8 HU	KJ16CR-L11	K16TT
14 FR-8 HUT	QJ16AR-U	-
14 FR-8 KU0	K16R-U	K16TT
14 FR-8 LDU3	K16TR11	K16TT
14 FR-8 LPU02	VKB16	-
14 FR-8 LU2T	KJ16CR-L11	K16TT
14 FR-8 MPUX2	IKH16	IKH16TT
14 FR-8 MUI2	K16HR-U11	KH16TT
14 GH-8 DTUR	W20EPBR-S	W20TT
14 K-5 DU	T22EP-U	-
14 K-6 DU	T20EPR-U	T20TT
14 K-6 DU0	T20EPR-U	T20TT
14 K-7 DU0	T20EPR-U	T20TT
14 K-8 DU	T16EPR-U	T16TT
14 K-8 DU0	T16EPR-U	T16TT
14 K-9 DU0	T16EPR-U	T16TT
14 KGR-6 KQU	T20EPR-U	T20TT
14 KGR-7 KQU	T20EPR-U	T20TT
14 KR-6 DU	T20EPR-U	T20TT
14 KR-6 KPUV02	ZT20EPR11	T20TT
14 KR-6 MPV	ITV24	-
14 KR-7 DPUV	ZT20EPR11	T20TT
14 KR-7 DUX	T20EPR-U	T20TT
14 KR-7 MPUV2	ITV16	ITV16TT
14 KR-7 MPUX2	PT16VR13	TV16TT
14 KR-8 MPUV2	ITV20	ITV20TT
14 KR-8 STUX	PT16VR13	TV16TT
14 R-4 CIU	GE5-1	-
14 R-6 DU	W20EPR-U	W20TT
14 R-6 DUX	W20EPR-U11	W20TT
14 R-7 BU	W20FPR-U	WF20TT
14 R-9 KPUV2	P16R13	W20TT
14 S-7 E	W20MR-U	-
14 X-AU	W20FSR-U	WF20TT
14 Z-4 AU	W24FSR	-
1404AS	IW31	-

BERU	DENSO	TT
14095AS	IW31	-
1410A	W14F-U	-
1410B	W14FPR-UL	-
1410C	W14E	-
1410D	W14EPR-U	IW16TT
1410DU	W14EPR-U	IW16TT
1410E	W14PR-U	-
142AS1	W27FSR	-
143A1	W24FSR	-
143AS1	IWF24	-
143AU	W24FSR	-
143CPU	GE3-1	-
143CS	IW24	-
143CU	W24ESR-U	-
143DP2	IW24	-
14-4 DPO	IW24	-
144A	W22FS-U	-
144A1	W24FSR	-
144A2	W22FS-U	-
144AS1	IWF24	-
144AU	W22FS-U	-
144B2	W22FPR-U	-
144C1	W24ESR-U	-
144C2	W22ESR-U	-
144CS1	IW24	-
14-5 AU	W22FS-U	-
14-5 BU	W22FPR-U	-
14-5 DTU	W22EPB	W22TT
14-5 DU	W22EPR-U	W22TT
14-5 DU0	W22EPR-U	W22TT
145A	W22FS-U	-
145B	W22FPR-U	-
145C	W22ESR-U	-
145D	W22EPR-U	W22TT
145D1	W22EPR-U	W22TT
145E	W22S-U	-
145F	W20PR-U	-
14-6 B	W20FPR-U	WF20TT
14-6 BU	W20FPR-U	WF20TT
14-6 D	W20EP-U	W20TT
14-6 D1	W20EPR-U	W20TT
14-6 DTU	W20EPB	W20TT
14-6 DU	W20EPR-U	W20TT
14-6 DU0	W20EPR-U	W20TT
146C	W20ESR-U	-
146DPO	IW20	IW20TT
14-7 A	W20FSR-U	WF20TT
147 AU	W20FSR-U	WF20TT
14-7 B	W20FPR-U	WF20TT
14-7 BU	W20FPR-U	WF20TT
14-7 D	W20EP-U	W20TT
14-7 DU0	W20EP-U	W20TT
147C	W20ESR-U	-
147DTU	W20EPB	W20TT
147DU	W20EPR-U	W20TT
147E	W20S-U	-
147F	W20PR-U	-
14-8 AU	W16FSR	-
14-8 DU0	W16EPR-U	W16TT
14-8 E	W16S-U	-
14-8 LUR	J16CR-U	W16TT
148A	W16FSR	-
148B	W16FPR-U	-
148BU	W16FPR-U	-
148C	W16ESR-U	-
148C1	W20ESR-U	-
148D	W16EPR-U	W16TT
148DC	W16EPR-U	W16TT
148DTU	W16EPB10	W16TT
148DU	W16EPR-U	W16TT

BERU	DENSO	TT
148F	W16PR-U	-
14-9 C	W16ESR-U	-
14-9 DTU	W16EPB10	W16TT
149DU	W14EPR-U	IW16TT
149DU0	W14EPR-U	IW16TT
149EU0	W14LM-U	-
14F03DAR	K22PBR-S	-
14F5DU	K22PR-U	-
14F5MPUR02	VKH22	-
14F5MPUR03	IKH22	-
14F6DPUR02	PK20PR-P8	IK20TT
14F6DSR	IK20	IK20TT
14F6DU0R	K20P-U	K20TT
14F7 LDUR	K20TXR	K20TT
14F7DPUR02	PK20PR-P8	IK20TT
14F7DPUR2	VK20	IK20TT
14F7DPURX2	PK20PR-P8	IK20TT
14F7DU0R	K20P-U	K20TT
14F7HPURX2	PKJ16CR-L11	IK16TT
14F7LDUR4	K20TXR	K20TT
14F8DPURX02	SK16PR-L11	IK16TT
14F8DU	K16PR-U11	K16TT
14F8DU4	K16PR-U11	K16TT
14F8DUX	Q16PR-U11	Q16TT
14F8LDUSR	K20TXR	K20TT
14FDH8DPURX2	PK16PR-L11	IK16TT
14FG8DTU	K20PBR-S10	K20TT
14FGH6DTUR	K20PBR-S10	K20TT
14FGH7DPURX2	SK20PR-L9	IK20TT
14FGH7DTRUR	K20PBR-S10	K20TT
14FGH8DPURX2	PK16PR-L11	IK16TT
14FG8DPURX2	PK16PR-L11	IK16TT
14FGR8DQU7	K20PBR	K20TT
14FGR8KQU	K20TXR	K20TT
14FR8LDUX	K20TXR	K20TT
14FR4DIU	GK3-1A	-
14FR4DPU0	GK3-1A	-
14-FR5 DTU	K22PBR-S	-
14FR5DPUX	IK20	IK20TT
14FR5DU	K22PR-U	-
14FR5LDU	K20TXR	K20TT
14FR6DPUX	VK20	IK20TT
14FR6DPUX02	PK20PR-L11	IK20TT
14FR6DU	K20PR-U	K20TT
14FR6DUX	Q20PR-U11	Q20TT
14FR6LDU	K22TNR-S	-
14FR6LDU0	K22TNR-S	-
14FR6LDU3	K22TNR-S	-
14FR6MPU2	VKH20	IKH20TT
14FR7DPU2	PK20PR-P8	IK20TT
14FR7DPU3	K20TXR	K20TT
14FR7DPUX	IK20	IK20TT
14FR7DPUX02	PK20PR-L11	IK20TT
14FR7DQUP7	K20TXR	K20TT
14FR7DU	K20PR-U	K20TT
14FR7DUW	K20PR-U	K20TT
14FR7DUX	K20PR-U11	K20TT
14FR7KDU	K20TXR	K20TT
14FR7KPU	PK20R8	IK20TT
14FR7KPUX	PK20R11	K20TT
14FR7KU	K20R-U	K20TT
14FR7KUOX	K20R-U11	K20TT
14FR7LDUW	K20TXR	K20TT
14FR7MU2	K20HR-U11	KH20TT
14FR7SPUX03	IKH20	IKH20TT
14FR8 LDU	K20TXR	K20TT
14FR8DPUX	IK16	IK16TT
14FR8DUX	K16PR-U11	K16TT
14FR8KU	K16R-U	K16TT
14FR8KU0U	K16R-U11	K16TT
14FR8LDU4	K20TXR	K20TT

Spark & Glow Plugs

Cross Reference Chart - Competitor

BERU	DENSO	TT
14FR8LDUOX4	K20TXR	K20TT
14FR8LU2	KJ16CR-L11	K16TT
14FR8NQU213	K20HR-U11	KH20TT
14FR9KUX2	KJ16CR-L11	K16TT
14FSH7DSUR	K20TXR	K20TT
14G8DTU	W20EPBR-S	W20TT
14GH7DTUR	W20EPBR-S	W20TT
14GH8DTURX	W20EPBR-S	W20TT
14GR8DTU	W20EPBR-S	W20TT
14K5DUO	T22EP-U	-
14K6D	T20EPR-U	T20TT
14K7D	T20EPR-U	T20TT
14K7DU	T20EPR-U	T20TT
14K9DU	T16EPR-U	T16TT
14KR10SUV2	ITL16	ITL16TT
14-KR6 BU	T20PR-U	ITF20TT
14KR6DPUV02	ZT20EPR11	T20TT
14KR6MPX	PT16VR10	TV16TT
14KR6ZPPV	PT16VR13	TV16TT
14KR7 DU	T20EPR-U	T20TT
14KR8DPUOV	PT16EPR-L13	IT16TT
14KR8DPUOV	PT16EPR-L13	IT16TT
14KR8MUV	PT16VR13	TV16TT
14KR9 DUX	T16EPR-U	T16TT
14R11F	W14PR-U	-
14R3CPU	GE3-1	-
14R4ADP	GN3-1A	-
14R4CDP	GE3-1	-
14-R5 DU	W22EPR-U	W22TT
14R5BIU	GN3-1A	-
14R5BPU	IWF22	-
14R5DPU	IW22	-
14R6B	W20FPR-U	WF20TT
14R6BU	W20FPR-U	WF20TT
14R6D	W20EPR-U	W20TT
14R7B	W20FPR-U	WF20TT
14R7CU	W20ESR-U	-
14R7D	W20EPR-U	W20TT
14R7DU	W20EPR-U	W20TT
14R7DUX	W20EPR-U11	W20TT
14R8DU	W16EPR-U	W16TT
14R8DU4	W16EPR-U	W16TT
14R8DUX	W16EPR-U11	W16TT
14R9DU	W16EPR-U	W16TT
14R9EU0	W14LM-U	-
14S5F	W22MPR-U	-
14S7F	W20MP-U	-
14SR6F	W22MPR-U	-
14Z3AU	W24FSR	-
14Z3CU	W27ESR-U	-
14Z4CU	W24ESR-U	-
14Z6A2	W20FSR-U	WF20TT
14Z7AU	W22FS-U	-
151 MJ	DG-001	-
151MJ	DG-001	-
162 MJ	DG-012	-
162MJ	DG-012	-
18 K-7 BU	MA20P-U	-
1810AU	L14-U	-
185AU	M22	-
187AU	M17	-
18GZ20	GI3-1	-
18GZ33	GT3-1	-
18GZ477	GI3-1	-
18GZ577	GL3-1	-
18GZ5772	GL3-1	-
18GZ677	GI3-1	-
18GZ6772	GI3-1	-
18GZ7	GI3-1	-
18K6BU	MA20P-U	-
18K8BU	MA16PR-U	-

BERU	DENSO	TT
226 569	DG-306	-
226 570	DG-245	-
266 031	DG-621	-
266020	DG-193	-
601 MJ	DG-012	-
601MJ	DG-012	-
603 MJ	DG-001	-
604 MJ	DG-012	-
631 MJ	DG-123	-
636 MJ	DG-001	-
642 MJ	DG-001	-
657 MJ	DG-202	-
661 MJ	DG-004	-
663 MJ	DG-001	-
666 MJ	DG-004	-
673 MJ	DG-198	-
689 MJ	DG-012	-
691 MJ	DG-001	-
705 MJ	DG-114	-
719 MJ	DG-001	-
724 MJ	DG-001	-
727 MJ	DG-001	-
730 MJ	DG-132	-
749 MJ	DG-143	-
783 MJ	DG-115	-
798 MJ	DG-001	-
844 MJ	DG-012	-
852 MJ	DG-006	-
853 MJ	DG-137	-
854 MJ	DG-137	-
855 MJ	DG-005	-
857 MJ	DG-012	-
858 MJ	DG-010	-
896 MJ	DG-159	-
898 MJ	DG-162	-
905 MJ	DG-101	-
908 MJ	DG-001	-
909 MJ	DG-001	-
912 MJ	DG-003	-
917 MJ	DG-001	-
920 MJ	DG-157	-
921 MJ	DG-198	-
927 MJ	DG-004	-
944 MJ	DG-133	-
945 MJ	DG-159	-
946 MJ	DG-124	-
947 MJ	DG-104	-
948 MJ	DG-106	-
955 MJ	DG-172	-
964 MJ	DG-161	-
966MJ	DG-007	-
970 MJ	DG-102	-
999 MJ	DG-101	-
CS1K	T16PR-U	ITF16TT
CS2K	T20PR-U	ITF20TT
G 1 SB	DG-012	-
G 10 SB	DG-004	-
G 2 SB	DG-001	-
G 3 SB	DG-001	-
G 4 SB	DG-123	-
G 6 SB	DG-001	-
G 7 SB	DG-001	-
G10SB	DG-004	-
G1SB	DG-012	-
G3SB	DG-001	-
G4SB	DG-123	-
G6SB	DG-001	-
G7SB	DG-001	-
GE 100	DG-177	-
GE 101	DG-190	-
GE 102	DG-178	-

BERU	DENSO	TT
GE 103	DG-191	-
GE 104	DG-192	-
GE 105	DG-194	-
GE 110	DG-609	-
GE 111	DG-619	-
GE 114	DG-608	-
GE 118	DG-607	-
GE 121 A	DG-603	-
GE 123	DG-610	-
GE100	DG-177	-
GE101	DG-190	-
GE102	DG-178	-
GE103	DG-191	-
GE104	DG-192	-
GE105	DG-194	-
GE108	DG-193	-
GE110	DG-609	-
GE111	DG-619	-
GE112	DG-621	-
GE114	DG-608	-
GE115	DG-193	-
GE118	DG-607	-
GE121A	DG-603	-
GE123	DG-610	-
GE125	DG-604	-
GN 003	DG-117	-
GN 005	DG-146	-
GN 007	DG-109	-
GN 008	DG-144	-
GN 010	DG-155	-
GN 012	DG-111	-
GN 013	DG-001	-
GN 015	DG-184	-
GN 016	DG-003	-
GN 017	DG-127	-
GN 018	DG-005	-
GN 019	DG-112	-
GN 022	DG-007	-
GN 024	DG-145	-
GN 026	DG-126	-
GN 027	DG-116	-
GN 030	DG-129	-
GN 033	DG-142	-
GN 035	DG-173	-
GN 037	DG-195	-
GN 039	DG-137	-
GN 041	DG-122	-
GN 042	DG-240	-
GN 043	DG-216	-
GN 044	DG-702	-
GN 045	DG-140	-
GN 046	DG-109	-
GN 050	DG-183	-
GN 053	DG-171	-
GN 054	DG-181	-
GN 055	DG-176	-
GN 056	DG-180	-
GN 057	DG-189	-
GN 058	DG-606	-
GN 059	DG-170	-
GN 060	DG-188	-
GN 061	DG-108	-
GN 062	DG-602	-
GN 063	DG-614	-
GN 065	DG-245	-
GN 068	DG-245	-
GN 070	DG-187	-
GN 072	DG-605	-
GN 073	DG-601	-
GN 097	DG-196	-
GN 101	DG-307	-

BERU	DENSO	TT
GN 102	DG-304	-
GN 103	DG-300	-
GN 104	DG-302	-
GN 107	DG-174	-
GN 108	DG-600	-
GN 109	DG-197	-
GN 853	DG-137	-
GN 854	DG-137	-
GN 855	DG-005	-
GN 857	DG-012	-
GN 860	DG-119	-
GN 905	DG-101	-
GN 908	DG-001	-
GN 909	DG-001	-
GN 912	DG-003	-
GN 917	DG-001	-
GN 927	DG-004	-
GN 939	DG-130	-
GN 944	DG-133	-
GN 948	DG-106	-
GN 954	DG-001	-
GN 955	DG-172	-
GN 959	DG-012	-
GN 961	DG-110	-
GN 963	DG-008	-
GN 964	DG-161	-
GN 970	DG-102	-
GN 985	DG-182	-
GN 989	DG-139	-
GN 991	DG-009	-
GN 992	DG-118	-
GN 993	DG-121	-
GN 997	DG-186	-
GN 999	DG-101	-
GN003	DG-117	-
GN005	DG-146	-
GN007	DG-109	-
GN008	DG-144	-
GN010	DG-155	-
GN012	DG-111	-
GN013	DG-001	-
GN015	DG-184	-
GN016	DG-003	-
GN017	DG-127	-
GN018	DG-005	-
GN019	DG-112	-
GN022	DG-007	-
GN024	DG-145	-
GN026	DG-126	-
GN027	DG-116	-
GN030	DG-129	-
GN033	DG-142	-
GN035	DG-173	-
GN037	DG-195	-
GN039	DG-137	-
GN041	DG-122	-
GN042	DG-240	-
GN043	DG-216	-
GN044	DG-702	-
GN045	DG-140	-
GN046	DG-109	-
GN047	DG-113	-
GN050	DG-183	-
GN053	DG-171	-
GN054	DG-181	-
GN055	DG-176	-
GN056	DG-180	-
GN057	DG-189	-
GN058	DG-606	-
GN059	DG-170	-
GN060	DG-188	-

Spark & Glow Plugs

Cross Reference Chart - Competitor

BERU	DENSO	TT
GN061	DG-108	-
GN062	DG-602	-
GN063	DG-614	-
GN064	DG-502	-
GN065	DG-245	-
GN067	DG-306	-
GN068	DG-245	-
GN070	DG-187	-
GN072	DG-605	-
GN073	DG-601	-
GN097	DG-196	-
GN101	DG-307	-
GN102	DG-304	-
GN103	DG-300	-
GN104	DG-302	-
GN106	DG-312	-
GN107	DG-174	-
GN109	DG-197	-
GN110	DG-305	-
GN853	DG-137	-
GN854	DG-137	-
GN855	DG-005	-
GN857	DG-012	-
GN858	DG-010	-
GN860	DG-119	-
GN905	DG-101	-
GN908	DG-001	-
GN909	DG-001	-
GN912	DG-003	-
GN917	DG-001	-
GN927	DG-004	-
GN939	DG-130	-
GN944	DG-133	-
GN948	DG-106	-
GN954	DG-001	-
GN955	DG-172	-
GN959	DG-012	-
GN961	DG-110	-
GN963	DG-008	-
GN964	DG-161	-
GN970	DG-102	-
GN985	DG-182	-
GN989	DG-139	-
GN991	DG-009	-
GN992	DG-118	-
GN993	DG-121	-
GN997	DG-186	-
GN999	DG-101	-
GV 001	DG-213	-
GV 004	DG-175	-
GV 105	DG-001	-
GV 602	DG-001	-
GV 603	DG-001	-
GV 604	DG-012	-
GV 631	DG-123	-
GV 636	DG-001	-
GV 642	DG-001	-
GV 657	DG-202	-
GV 661	DG-004	-
GV 663	DG-001	-
GV 666	DG-004	-
GV 673	DG-198	-
GV 678	DG-234	-
GV 688	DG-221	-
GV 689	DG-012	-
GV 691	DG-001	-
GV 705	DG-114	-
GV 719	DG-001	-
GV 724	DG-001	-
GV 727	DG-001	-
GV 730	DG-132	-
GV 749	DG-143	-
GV 783	DG-115	-
GV 798	DG-001	-
GV 819	DG-121	-
GV 844	DG-012	-
GV 852	DG-006	-
GV 886	DG-223	-
GV 894	DG-215	-
GV 895	DG-222	-
GV 896	DG-159	-
GV 897	DG-232	-
GV 898	DG-162	-
GV 920	DG-157	-
GV 921	DG-198	-
GV 945	DG-159	-
GV 946	DG-124	-
GV 947	DG-104	-
GV 967	DG-216	-
GV 968	DG-211	-
GV 969	DG-233	-
GV001	DG-213	-
GV004	DG-175	-
GV105	DG-001	-
GV602	DG-001	-
GV603	DG-001	-
GV604	DG-012	-
GV631	DG-123	-
GV636	DG-001	-
GV642	DG-001	-
GV657	DG-202	-
GV661	DG-004	-
GV663	DG-001	-
GV666	DG-004	-
GV673	DG-198	-
GV678	DG-234	-
GV688	DG-221	-
GV689	DG-012	-
GV691	DG-001	-
GV705	DG-114	-
GV719	DG-001	-
GV724	DG-001	-
GV727	DG-001	-
GV730	DG-132	-
GV749	DG-143	-
GV783	DG-115	-
GV798	DG-001	-
GV819	DG-121	-
GV844	DG-012	-
GV852	DG-006	-
GV886	DG-223	-
GV894	DG-215	-
GV895	DG-222	-
GV896	DG-159	-
GV897	DG-232	-
GV898	DG-162	-
GV920	DG-157	-
GV921	DG-198	-
GV945	DG-159	-
GV946	DG-124	-
GV947	DG-104	-
GV967	DG-216	-
GV968	DG-211	-
GV969	DG-233	-
RS16	IWF20	-
RS18	IWF22	-
RS35	IW20	IW20TT
RS37	IW20	IW20TT
RS39	IW22	-
S1K	T20EPR-U	T20TT
S2K	IT22	-
S3F	IK20	IK20TT

BERU	DENSO	TT
GV 749	DG-143	-
GV 783	DG-115	-
GV 798	DG-001	-
GV 819	DG-121	-
GV 844	DG-012	-
GV 852	DG-006	-
GV 886	DG-223	-
GV 894	DG-215	-
GV 895	DG-222	-
GV 896	DG-159	-
GV 897	DG-232	-
GV 898	DG-162	-
GV 920	DG-157	-
GV 921	DG-198	-
GV 945	DG-159	-
GV 946	DG-124	-
GV 947	DG-104	-
GV 967	DG-216	-
GV 968	DG-211	-
GV 969	DG-233	-
GV001	DG-213	-
GV004	DG-175	-
GV105	DG-001	-
GV602	DG-001	-
GV603	DG-001	-
GV604	DG-012	-
GV631	DG-123	-
GV636	DG-001	-
GV642	DG-001	-
GV657	DG-202	-
GV661	DG-004	-
GV663	DG-001	-
GV666	DG-004	-
GV673	DG-198	-
GV678	DG-234	-
GV688	DG-221	-
GV689	DG-012	-
GV691	DG-001	-
GV705	DG-114	-
GV719	DG-001	-
GV724	DG-001	-
GV727	DG-001	-
GV730	DG-132	-
GV749	DG-143	-
GV783	DG-115	-
GV798	DG-001	-
GV819	DG-121	-
GV844	DG-012	-
GV852	DG-006	-
GV886	DG-223	-
GV894	DG-215	-
GV895	DG-222	-
GV896	DG-159	-
GV897	DG-232	-
GV898	DG-162	-
GV920	DG-157	-
GV921	DG-198	-
GV945	DG-159	-
GV946	DG-124	-
GV947	DG-104	-
GV967	DG-216	-
GV968	DG-211	-
GV969	DG-233	-
RS16	IWF20	-
RS18	IWF22	-
RS35	IW20	IW20TT
RS37	IW20	IW20TT
RS39	IW22	-
S1K	T20EPR-U	T20TT
S2K	IT22	-
S3F	IK20	IK20TT

BERU	DENSO	TT
S5	IW20	IW20TT
S6	IWF22	-
S7	IW20	IW20TT
S9	IW22	-
UXF79P	K20TXR	K20TT
Z 213	K20TXR	K20TT
Z1	W16EPR-U	W16TT
Z10	W20FPR-U	WF20TT
Z100	K16PR-U11	K16TT
Z101	K20TXR	K20TT
Z102	GE3-1	-
Z103	IW24	-
Z104	IW20	IW20TT
Z105	IK20	IK20TT
Z11	W20EPR-U	W20TT
Z112	W16S-U	-
Z116	K22TNR-S	-
Z117	T16EPR-U	T16TT
Z118	W16FPR-U	-
Z119	W16EPR-U	W16TT
Z12	W20EPB	W20TT
Z120	K20PBR-S10	K20TT
Z121	K20PBR-S10	K20TT
Z122	PK16PR-L11	IK16TT
Z123	K20TXR	K20TT
Z126	K20PBR-S10	K20TT
Z127	T20EPR-U	T20TT
Z129	K20PBR-S10	K20TT
Z13	K20P-U	K20TT
Z130	IK20	IK20TT
Z14	K20TXR	K20TT
Z144	T20EPR-U	T20TT
Z145	K20TXR	K20TT
Z146	GN3-1A	-
Z147	GE3-1	-
Z148	PT16EPR-L13	IT16TT
Z149	PK20R11	K20TT
Z15	K20PR-U	K20TT
Z150	PQ20R	Q20TT
Z151	PK20R8	IK20TT
Z152	KJ16CR-L11	K16TT
Z153	K16R-U	K16TT
Z154	K16R-U	K16TT
Z155	K20R-U	K20TT
Z156	K20R-U	K20TT
Z157	K20R-U11	K20TT
Z158	KJ20CR-L11	K20TT
Z159	VK20	IK20TT
Z16	K20PR-U11	K20TT
Z161	GL3-1	-
Z162	GI3-1	-
Z163	GE3-1	-
Z168	GI3-1	-
Z17	T20EPR-U	T20TT
Z171	PK20PR-P8	IK20TT
Z172	K20PBR-S10	K20TT
Z173	K20TXR	K20TT
Z176	PKJ16CR-L11	IK16TT
Z177	PT16VR13	TV16TT
Z178	GI3-1	-
Z179	GI3-1	-
Z18	T20EPR-U	T20TT
Z183	K16HPR-U11	KH16TT
Z184	K20HR-U11	KH20TT
Z185	VK22	-
Z187	GE5-1	-
Z188	PK20PR-P8	IK20TT
Z189	GK3-1A	-
Z19	W20FPR-U	WF20TT
Z190	K20PBR	K20TT
Z192	K20TXR	K20TT

BERU	DENSO	TT
Z193	K20PR-U	K20TT
Z194	K22TNR-S	-
Z195	GN3-1A	-
Z2	W16EPB10	W16TT
Z20	W20EPR-U	W20TT
Z200	KJ16CR-L11	K16TT
Z201	GL3-1	-
Z202	GI3-1	-
Z203	KJ16CR-L11	K16TT
Z204	K20PBR-S10	K20TT
Z205	GE5-1	-
Z206	PK20PR-P8	IK20TT
Z208	K16TR11	K16TT
Z209	ZT20EPR11	T20TT
Z21	W20EPR-U11	W20TT
Z210	IU22	-
Z211	IKH16	IKH16TT
Z212	GK3-1A	-
Z213	K20TXR	K20TT
Z216	ITL16	ITL16TT
Z22	W20EPR-U	W20TT
Z220	KJ16CR-L11	K16TT
Z221	PK20PR-L11	IK20TT
Z222	PT16VR13	TV16TT
Z224	K20TXR	K20TT
Z225	KJ20CR-L11	K20TT
Z226	VKH20	IKH20TT
Z227	K20PR-U	K20TT
Z228	PK20PR-L11	IK20TT
Z23	K20P-U	K20TT
Z230	ZT20EPR11	T20TT
Z233	VXUH22	-
Z234	XU22PR9	XU22TT
Z235	IKH20	IKH20TT
Z237	K20TXR	K20TT
Z239	K20PBR-S10	K20TT
Z24	K20PR-U	K20TT
Z240	SK16PR-L11	IK16TT
Z243	XE20HR-U9	IXE20TT
Z247	K20PR-U	K20TT
Z248	QJ16AR-U	-
Z249	K16R-U11	K16TT
Z25	T20EPR-U	T20TT
Z255	K16PR-U	K16TT
Z257	K20TXR	K20TT
Z26	T20EPR-U	T20TT
Z265	W22MPR-U	-
Z266	W20MR-U	-
Z27	W20EPR-U	W20TT
Z272	KJ20DR-M11	IK20TT
Z273	K20HR-U11	KH20TT
Z277	IKH22	-
Z278	VKB16	-
Z279	VKB20	-
Z28	W20EPR-U11	W20TT
Z280	SK20R11	IK20TT
Z282	SK20PR-L9	IK20TT
Z284	PK20PR-L11	IK20TT
Z285	P16R13	W20TT
Z287	KJ16CR-L11	K16TT
Z288	VXUH22	-
Z29	K22PR-U	-
Z291	XU24EPR-U	-
Z292	XU22EPR-U	XU22TT
Z293	XU22EPR-U	XU22TT
Z294	IKH22	-
Z295	VKB20	-
Z296	ZT20EPR11	T20TT
Z299	KJ20DR-M11	IK20TT
Z3	J16CR-U	W16TT
Z30	K22PR-U	-

BERU	DENSO	TT
Z300	K20PBR-S10	K20TT
Z301	VK20	IK20TT
Z302	IKH16	IKH16TT
Z304	K20PBR-S10	K20TT
Z307	SK16PR-E11	IK16TT
Z308	XU22HDR9	XUH22TT
Z31	T22EP-U	-
Z310	ITV20	ITV20TT
Z314	PK20PR-P8	IK20TT
Z315	ITV24	-
Z318	VXUH22	-
Z32	MA20P-U	-
Z321	VK20	IK20TT
Z322	VK20	IK20TT
Z324	K16TNR-S9	K16TT
Z325	FXE20HR11	IXEH20TT
Z326	IKH22	-
Z332	IXUH22	-
Z336	VXUH22	-
Z337	PK20PR-P8	IK20TT
Z339	VKH22	-
Z340	VW20	IW20TT
Z342	ITV16	ITV16TT
Z343	PK16PR-L11	IK16TT
Z346	IK20L	IK20TT
Z347	PK22PR8	-
Z354	SKJ20DR-M11	IK20TT
Z356	PT16VR13	TV16TT
Z36	X22EPR-U9	-
Z360	K20BR-S10	K20TT
Z38	W27ESR-U	-
Z39	W24FSR	-
Z4	KJ16CR11	K16TT
Z40	W22FS-U	-
Z41	W22FPR-U	-
Z42	W22EPR-U	W22TT
Z43	W22EPR-U	W22TT
Z44	W22EPB	W22TT
Z45	K22PBR-S	-
Z47	W22EPR-U	W22TT
Z48	W20FPR-U	WF20TT
Z49	T20PR-U	ITF20TT
Z5	K16PR-U11	K16TT
Z50	W20EPR-U	W20TT
Z51	W20EPB	W20TT
Z52	K20PBR	K20TT
Z53	K20PBR	K20TT
Z54	K20P-U	K20TT
Z56	T20EPR-U	T20TT
Z57	W20FSR-U	WF20TT
Z58	W20ESR-U	-
Z6	T16EPR-U	T16TT
Z60	K20PBR-S10	K20TT
Z61	W20EP-U	W20TT
Z62	W20EP-U	W20TT
Z63	K20P-U	K20TT
Z64	K20P-U	K20TT
Z67	T20EPR-U	T20TT
Z68	W16FSR	-
Z69	W16EPR-U	W16TT
Z7	T16EPR-U	T16TT
Z70	W16EPR-U	W16TT
Z71	K16PR-U11	K16TT
Z72	K16PR-U	K16TT
Z73	K16PR-U11	K16TT
Z74	K20TXR	K20TT
Z75	W20EPBR-S	W20TT
Z76	W14EPR-U	IW16TT
Z77	W14EPR-U	IW16TT
Z78	W16EPB10	W16TT
Z79	K16PR-U11	K16TT

BERU	DENSO	TT
Z8	W16EPR-U	W16TT
Z80	T16EPR-U	T16TT
Z81	T16EPR-U	T16TT
Z82	W16EPR-U	W16TT
Z85	W20FSR-U	WF20TT
Z87	M17	-
Z89	K20PBR-S10	K20TT
Z9	W16EPR-U11	W16TT
Z90	K20PBR-S10	K20TT
Z91	W20EPBR-S	W20TT
Z92	W20EPBR-S	W20TT
Z93	W20EPBR-S	W20TT
Z94	W20EPBR-S	W20TT
Z95	T20EPR-U	T20TT
Z97	PT16VR10	TV16TT
Z98	K20TNR	K20TT
Z99	Q20PR-U11	Q20TT

BLITZ	DENSO	TT
R610510	IQ31	-
R61057	IQ22	-
R61058	IQ24	-
R61059	IQ27	-
R6187105	IRE01-32	-
R618711	IRE01-34	-
T7340B6	IK20	IK20TT
T7340B7	IK22	-
T7340B8	IK24	-
T7341B6	IQ20	IQ20TT
T7341B7	IQ22	-
T7341B8	IQ24	-

BLUE PRINT	DENSO	TT
ADH21803	DG-601	-

BOSCH	DENSO	TT
+1	W20EPR-U	W20TT
+10	W20FPR-U	WF20TT
+11	K20PR-U11	K20TT
+12	W20EPR-U	W20TT
+13	K20PR-U	K20TT
+14	T20EPR-U	T20TT
+15	W22EPR-U	W22TT
+16	W16EPR-U	W16TT
+17	PT16VR13	TV16TT
+18	T20EPR-U	T20TT
+19	K16PR-U11	K16TT
+2	W20EPBR-S	W20TT
+20	W16FPR-U	-
+21	W20EPR-U11	W20TT
+22	W16EPR-U11	W16TT
+23	K20PBR-S10	K20TT
+24	PK20PR-P8	IK20TT
+3	W16EPR-U	W16TT
+31	K20R-U11	K20TT
+32	KJ20CR-U11	K20TT
+36	K16TR11	K16TT
+38	VK20	IK20TT
+39	T16VR-U10	TV16TT
+4	W20EPBR-S	W20TT
+40	XE20HR-U9	IXEH20TT
+41	XU22EPR-U	XU22TT
+42	K16HPR-U11	KH16TT
+43	K16R-U	K16TT
+44	K20PBR-S10	K20TT
+45	PK16PR-L11	IK16TT
+46	T20EPR-U	T20TT
+47	K20R-U	K20TT
+48	K20TXR	K20TT
+49	ZT20EPR11	T20TT
+5	T20EPR-U	T20TT

BOSCH	DENSO	TT
+50	PK20PR-P8	IK20TT
+51	KJ16CR-L11	K16TT
+52	PKJ20CR-L11	IK20TT
+53	K20TNR-S	K20TT
+55	PQ20R-P8	IQ20TT
+6	K16PR-U	K16TT
+7	K20TXR	K20TT
+8	K20PR-U	K20TT
+9	K20TXR	K20TT
0 241 040 501	U20FSR-U	-
0 241 045 001	U20FSR-U	-
0 241 050 002	U22FSR-U	-
0 241 056 501	U22ESR-N	-
0 241 140 500	XU20EPR-U	-
0 241 145 500	X22EPR-U9	-
0 241 145 501	X22ESR-U	-
0 241 145 510	XU22EPR-U	XU22TT
0 241 150 503	X27EPR-U9	-
0 241 150 504	X24ESR-U	-
0 241 200 500	SF-50	-
0 241 219 540	W14F-U	-
0 241 219 541	W14E	-
0 241 219 543	W14F-U	-
0 241 219 554	W14PR-U	-
0 241 219 555	W9EP	-
0 241 225 547	W14E	-
0 241 225 548	W14PR-U	-
0 241 225 549	W14F-U	-
0 241 225 573	T16EPR-U	T16TT
0 241 225 581	W16ETR-S	W16TT
0 241 225 590	W14LM-U	-
0 241 225 593	W14EPR-U	IW16TT
0 241 229 541	T20M-U	-
0 241 229 560	W20MR-U	-
0 241 229 561	W20MP-U	-
0 241 229 579	W16ESR-U	-
0 241 229 580	W16S-U	-
0 241 229 612	W16FSR	-
0 241 229 617	T16EPR-U	T16TT
0 241 229 676	K20PBR-S10	K20TT
0 241 229 712	K16PR-U11	K16TT
0 241 229 713	K16PR-U11	K16TT
0 241 229 714	W16FPR-U	-
0 241 229 716	W20EPB	W20TT
0 241 229 724	W16EPR-U	W16TT
0 241 229 725	W16FSR	-
0 241 235 089	W20ESR-U	-
0 241 235 566	W20MR-U	-
0 241 235 594	W20S-U	-
0 241 235 607	W20FSR-U	WF20TT
0 241 235 610	W20EPR-U11	W20TT
0 241 235 619	W20FSR-U	WF20TT
0 241 235 623	W20PR-U	-
0 241 235 689	W20EPB	W20TT
0 241 235 706	K20PBR-S10	K20TT
0 241 235 713	T20M-U	-
0 241 235 729	T20MP-U	-
0 241 235 750	K20P-U	K20TT
0 241 235 751	K20TXR	K20TT
0 241 235 752	K20PBR-S10	K20TT
0 241 235 755	W20EPR-U	W20TT
0 241 235 756	W20EPB	W20TT
0 241 235 757	W20EPBR-S	W20TT
0 241 235 776	T20EPR-U	T20TT
0 241 240 552	T20EPR-U	T20TT
0 241 240 585	IK20	IK20TT
0 241 240 597	IK20	IK20TT
0 241 240 600	W20MR-U	-
0 241 240 601	W20MP-U	-
0 241 240 602	T22M-U	-
0 241 240 603	W20FSR-U	WF20TT

BOSCH	DENSO	TT
0 241 240 604	W22ESR-U	-
0 241 240 608	K20P-U	K20TT
0 241 240 609	K20PBR	K20TT
0 241 240 610	T20EPR-U	T20TT
0 241 240 611	W20EP-U	W20TT
0 241 242 502	T22EP-U	-
0 241 245 044	W22EPR-U	W22TT
0 241 245 539	T22M-U	-
0 241 245 554	W22M-U	-
0 241 245 555	W22MPR-U	-
0 241 245 574	IWF22	-
0 241 245 580	W22FS-U	-
0 241 245 581	W22ESR-U	-
0 241 245 602	W22FS-U	-
0 241 245 641	IK22	-
0 241 245 655	K22PR-U	-
0 241 247 500	IW24	-
0 241 248 531	W24FSR	-
0 241 248 538	W24ESR-U	-
0 241 250 512	IW24	-
0 241 250 514	IT24	-
0 241 250 526	IK24	-
0 241 252 521	IWF24	-
0 241 252 522	IW24	-
0 241 255 505	IT24	-
0 241 255 507	IK27	-
0 241 256 515	IW24	-
0 241 256 517	IW24	-
0 241 256 519	W24FSR	-
0 241 256 522	W24ESR-U	-
0 241 260 507	W27FSR	-
0 241 260 508	W27ESR-U	-
0 241 260 510	IT27	-
0 241 260 512	IK27	-
0 241 262 505	IWF27	-
0 241 262 506	IW31	-
0 241 265 501	IK31	-
0 241 268 505	IWF27	-
0 241 268 506	IW31	-
0 241 268 508	IK31	-
0 241 274 504	W31FS	-
0 241 274 505	IW34	-
0 241 280 503	IW34	-
0 241 309 501	L14-U	-
0 241 319 513	L14-U	-
0 241 329 522	MA16PR-U	-
0 241 329 526	L14-U	-
0 241 335 526	M17	-
0 241 335 528	MA20P-U	-
0 241 340 501	MA20P-U	-
0 241 345 512	M22	-
0 241 350 505	M24S	-
0 242 040 500	U20FSR-U	-
0 242 040 502	IU22	-
0 242 050 501	U22FSR-U	-
0 242 055 502	U22ESR-N	-
0 242 055 505	U22FSR-U	-
0 242 060 501	U24ESR-N	-
0 242 129 502	X20EPR-U9	-
0 242 129 506	XE20HR-U9	IXEH20TT
0 242 129 508	XE20HR-U9	IXEH20TT
0 242 129 510	XE20HR-U9	IXEH20TT
0 242 129 512	VXUH22	-
0 242 129 514	FXE20HR11	IXEH20TT
0 242 129 515	XU22HDR9	XUH22TT
0 242 135 501	XU22EPR-U	XU22TT
0 242 135 502	X22EPR-U9	-
0 242 135 509	SXU22HDR8	-
0 242 135 510	VXU22	-
0 242 135 515	XU22EPR-U	XU22TT
0 242 135 518	VXUH22	-

Spark & Glow Plugs

Cross Reference Chart - Competitor

BOSCH	DENSO	TT
0 242 135 524	FXE20HE11	IKEH20ETT
0 242 135 527	XU22HDR9	XUH22TT
0 242 135 529	SC20HR11	IKEH22TT
0 242 135 531	FXE20HE11	IKEH20ETT
0 242 140 500	X24ESR-U	-
0 242 140 504	XU22EPR-U	XU22TT
0 242 140 512	VXUH22	-
0 242 140 515	SXU22HDR8	-
0 242 140 519	XU22PR9	XU22TT
0 242 140 530	XE20HR-U9	IKEH20TT
0 242 145 500	X22EPR-U9	-
0 242 145 503	XU24EPR-U	-
0 242 145 504	XU24EPR-U	-
0 242 145 510	SXU22HDR8	-
0 242 150 501	X24ESR-U	-
0 242 160 501	IX24	-
0 242 209 500	W9LMR-US	-
0 242 215 500	W9PR-U	-
0 242 215 502	W9LMR-US	-
0 242 219 004	W14FR-U	-
0 242 219 512	W14PR-U	-
0 242 219 513	W14PR-U	-
0 242 219 515	T14PR-U	ITF16TT
0 242 219 517	T14PR-U	ITF16TT
0 242 219 522	T14PR-U	ITF16TT
0 242 219 525	W14EPR-U	IW16TT
0 242 219 527	T16EPR-U	T16TT
0 242 219 530	J16CR-U	W16TT
0 242 219 532	K16PR-U	K16TT
0 242 219 535	W14EXR-U11	IK16TT
0 242 219 537	K16PR-U11	K16TT
0 242 219 539	T14PR-U	ITF16TT
0 242 219 541	T14PR-U	ITF16TT
0 242 219 544	T16EPR-U	T16TT
0 242 219 547	W14PR-U	-
0 242 219 548	J16CR-U	W16TT
0 242 219 549	J16CR-U	W16TT
0 242 222 501	VW16	IW16TT
0 242 222 502	VW16	IW16TT
0 242 222 503	K16TNR-S9	K16TT
0 242 222 507	T16PR-U	ITF16TT
0 242 225 528	J16AR-U11	-
0 242 225 533	T16EPR-U	T16TT
0 242 225 534	T16EPR-U15	T16TT
0 242 225 537	QJ16HR-U9	-
0 242 225 538	W14EPR-U	IW16TT
0 242 225 539	J16CR-U	W16TT
0 242 225 549	Q14R-U11	IQ16TT
0 242 225 552	T20NR-U11	IT20TT
0 242 225 553	W14EPR-U	IW16TT
0 242 225 554	W14EXR-U11	IW16TT
0 242 225 580	KJ16CR-L11	K16TT
0 242 225 582	Q14R-U11	IQ16TT
0 242 225 596	K16TNR-S9	K16TT
0 242 225 599	W16EPR-U	W16TT
0 242 225 610	J16CR-U	W16TT
0 242 225 611	PTJ16R15	IT16TT
0 242 225 622	T16PR-U	ITF16TT
0 242 225 623	T16EPR-U15	T16TT
0 242 225 624	W14EXR-U11	IW16TT
0 242 225 625	J16CR-U	W16TT
0 242 225 626	J16CR-U	W16TT
0 242 225 641	T16PR-U15	ITF16TT
0 242 225 642	T16EPR-U	T16TT
0 242 225 643	T16EPR-U15	T16TT
0 242 225 645	T20NR-U11	IT20TT
0 242 225 659	VT16	IT16TT
0 242 225 668	ITL16	ITL16TT
0 242 229 525	W16PR-U	-
0 242 229 528	T16PR-U	ITF16TT
0 242 229 529	T16PR-U15	ITF16TT

BOSCH	DENSO	TT
0 242 229 533	W16ESR-U	-
0 242 229 534	W16FSR	-
0 242 229 537	W16EPR-U	W16TT
0 242 229 543	IK16	IK16TT
0 242 229 544	QJ16HR-U9	-
0 242 229 545	IT16	IT16TT
0 242 229 555	IW16	IW16TT
0 242 229 556	W16ESR-U	-
0 242 229 557	IW16	IW16TT
0 242 229 576	KJ16CR-L11	K16TT
0 242 229 579	PKJ16CR-L11	IK16TT
0 242 229 586	W16FPR-U	-
0 242 229 590	QJ16HR-U9	-
0 242 229 598	IK16	IK16TT
0 242 229 604	T16EPR-U15	T16TT
0 242 229 613	K20PBR-S10	K20TT
0 242 229 628	K16TR11	K16TT
0 242 229 630	K16HPR-U11	KH16TT
0 242 229 635	K16R-U11	K16TT
0 242 229 641	PT16EPR-L13	IT16TT
0 242 229 643	W14MR-U	-
0 242 229 648	K20PBR-S10	K20TT
0 242 229 650	T16VR-U10	TV16TT
0 242 229 652	PT16EPR-L13	IT16TT
0 242 229 654	K20TXR	K20TT
0 242 229 655	T20EPR-U	T20TT
0 242 229 656	W16EPR-U	W16TT
0 242 229 657	W16FPR-U	-
0 242 229 658	W20EPBR-S	W20TT
0 242 229 659	K16PR-U	K16TT
0 242 229 660	K16PR-U11	K16TT
0 242 229 661	PT16VR13	TV16TT
0 242 229 676	W16FSR	-
0 242 229 678	IT16	IT16TT
0 242 229 680	IW16	IW16TT
0 242 229 687	W16EPR-U11	W16TT
0 242 229 692	W16EPR-U	W16TT
0 242 229 699	KJ16CR-L11	K16TT
0 242 229 702	K16HPR-U11	KH16TT
0 242 229 708	VKH16	IKH16TT
0 242 229 712	K20TXR	K20TT
0 242 229 715	KJ16CR-L11	K16TT
0 242 229 719	IK16	IK16TT
0 242 229 722	IKH16	IKH16TT
0 242 229 723	IT16	IT16TT
0 242 229 737	T16EPR-U	T16TT
0 242 229 739	PT16VR13	TV16TT
0 242 229 752	ITV16	ITV16TT
0 242 229 773	T20R-U	-
0 242 229 775	T16EPR-U	T16TT
0 242 229 779	J16CR-U	W16TT
0 242 229 782	K16TR11	K16TT
0 242 229 785	T16VR-U10	TV16TT
0 242 229 796	PT16VR13	TV16TT
0 242 229 797	K16HPR-U11	KH16TT
0 242 229 798	K16R-U	K16TT
0 242 229 799	K20PBR-S10	K20TT
0 242 230 500	PK16PR-L11	IK16TT
0 242 230 505	K16PSR-B8	IK16TT
0 242 230 508	ITL16	ITL16TT
0 242 230 519	SK16PR-E11	IK16TT
0 242 230 533	SK16HR11	IKH16TT
0 242 232 501	VK20	IK20TT
0 242 232 502	VK20	IK20TT
0 242 232 504	W20EPBR-S	W20TT
0 242 232 505	W20EPBR-S	W20TT
0 242 232 506	IWF20	-
0 242 232 507	VT20	IT20TT
0 242 232 508	VT20	IT20TT
0 242 232 509	W20	IW20TT
0 242 235 525	IW20	IW20TT
0 242 235 532	W20ESR-U	-

BOSCH	DENSO	TT
0 242 235 533	W20FSR-U	WF20TT
0 242 235 535	IWF22	-
0 242 235 540	IW20	IW20TT
0 242 235 541	IW20	IW20TT
0 242 235 546	W20ESR-U	-
0 242 235 547	IK20	IK20TT
0 242 235 554	W20SR-U	-
0 242 235 556	IK20	IK20TT
0 242 235 571	W20EPBR-S	W20TT
0 242 235 607	T20EPR-U	T20TT
0 242 235 610	K20R-U	K20TT
0 242 235 640	K20PR-U	K20TT
0 242 235 650	J16CR-U	W16TT
0 242 235 651	W20MPR-U10	-
0 242 235 656	K20PBR-S10	K20TT
0 242 235 661	T20EPR-U	T20TT
0 242 235 663	W20EPR-U	W20TT
0 242 235 664	W20EPBR-S	W20TT
0 242 235 665	W20FPR-U	WF20TT
0 242 235 666	K20PR-U	K20TT
0 242 235 667	K20PR-U11	K20TT
0 242 235 668	K20TXR	K20TT
0 242 235 690	PK20PR11	K20TT
0 242 235 692	K16GPR-U11	-
0 242 235 696	IKH20	IKH20TT
0 242 235 700	IT20	IT20TT
0 242 235 703	IWF22	-
0 242 235 707	W20EPR-U11	W20TT
0 242 235 715	K20PBR-S10	K20TT
0 242 235 740	PK20PR-P8	IK20TT
0 242 235 743	VKH20	IKH20TT
0 242 235 748	K20PBR-S10	K20TT
0 242 235 749	PK20PR-P8	IK20TT
0 242 235 751	W20EPR-U11	W20TT
0 242 235 756	VKH20	IKH20TT
0 242 235 758	K20HR-U11	KH20TT
0 242 235 766	K20PBR-S10	K20TT
0 242 235 767	PT16VR13	TV16TT
0 242 235 769	IKH20	IKH20TT
0 242 235 775	VK20	IK20TT
0 242 235 776	VK20	IK20TT
0 242 235 791	K20HR-U11	KH20TT
0 242 235 797	K20PR-U	K20TT
0 242 235 916	PT16VR13	TV16TT
0 242 236 510	VKH20	IKH20TT
0 242 236 511	VK20	IK20TT
0 242 236 528	VKH20	IKH20TT
0 242 236 541	K20R-U11	K20TT
0 242 236 543	T20EPR-U15	T20TT
0 242 236 544	VK20	IK20TT
0 242 236 556	IK20	IK20TT
0 242 236 557	IK20	IK20TT
0 242 236 558	IK20	IK20TT
0 242 236 559	IT20	IT20TT
0 242 236 560	T20EPR-U	T20TT
0 242 236 561	K20R-U	K20TT
0 242 236 562	K20TXR	K20TT
0 242 236 563	ZT20EPR11	T20TT
0 242 236 564	PK20PR-P8	IK20TT
0 242 236 565	KJ16CR-L11	K16TT
0 242 236 566	PKJ20CR-L11	IK20TT
0 242 236 571	VK22	-
0 242 236 572	VKB20	-
0 242 236 574	ITV20	ITV20TT
0 242 236 576	IW20	IW20TT
0 242 236 577	VKH20Y	-
0 242 236 580	W20ESR-U	-
0 242 236 583	VK20	IK20TT
0 242 236 593	SK20HR11	IKH20TT
0 242 236 599	VK20	IK20TT
0 242 236 605	FK20HR11	IKH20TT

BOSCH	DENSO	TT
0 242 236 610	DK20PR-D13	-
0 242 240 004	IW20	IW20TT
0 242 240 519	T20EPR-U	T20TT
0 242 240 520	T20PR-U	ITF20TT
0 242 240 521	IW20	IW20TT
0 242 240 522	T20EPR-U	T20TT
0 242 240 528	K20PBR	K20TT
0 242 240 530	IK20	IK20TT
0 242 240 531	W20EPR-U11	W20TT
0 242 240 533	IK20	IK20TT
0 242 240 539	K20PR-U11	K20TT
0 242 240 555	IW20	IW20TT
0 242 240 558	IK20	IK20TT
0 242 240 561	W20FPR-U	WF20TT
0 242 240 562	K20TNR-S	K20TT
0 242 240 564	K22TNR-S	-
0 242 240 566	K20TR11	K20TT
0 242 240 569	T20EPR-U	T20TT
0 242 240 572	K20PBR	K20TT
0 242 240 576	W22MPR-U	-
0 242 240 577	K20PR-U	K20TT
0 242 240 582	W20MR-U	-
0 242 240 584	K20TXR	K20TT
0 242 240 585	W22FSR	-
0 242 240 586	W22ESR-U	-
0 242 240 587	K20PBR-S10	K20TT
0 242 240 590	K20PBR-S10	K20TT
0 242 240 591	T20EPR-U	T20TT
0 242 240 592	W20EPR-U	W20TT
0 242 240 593	K20PR-U	K20TT
0 242 240 615	PK20PR11	K20TT
0 242 240 618	K20PBR	K20TT
0 242 240 619	VKH20	IKH20TT
0 242 240 620	ZT20EPR11	T20TT
0 242 240 621	PK20PR11	K20TT
0 242 240 625	PQ20R-P8	IQ20TT
0 242 240 627	VK20	IK20TT
0 242 240 628	PK20PR-P8	IK20TT
0 242 240 635	K20HR-U11	KH20TT
0 242 240 637	VKH20	IKH20TT
0 242 240 638	K20PR-U11	K20TT
0 242 240 648	K20TNR-S	K20TT
0 242 240 649	PK20PR-L11	IK20TT
0 242 240 650	PQ20R-P8	IQ20TT
0 242 240 653	SK20PR-A8	IK20TT
0 242 240 692	VK20	IK20TT
0 242 240 860	PK20PR-L11	IK20TT
0 242 242 501	IK22	-
0 242 242 505	VW22	-
0 242 245 018	K22PBR-S	-
0 242 245 514	IW22	-
0 242 245 517	W22FSR	-
0 242 245 519	IW22	-
0 242 245 520	IK22	-
0 242 245 521	W22ESR-U	-
0 242 245 527	T22EP-U	-
0 242 245 533	W22MPR-U	-
0 242 245 536	K22PR-U	-
0 242 245 539	K22PBR-S	-
0 242 245 550	K22PR-U11	-
0 242 245 552	W22EPR-U	W22TT
0 242 245 556	IWF22	-
0 242 245 558	PK22PR-L11S	-
0 242 245 559	IK22	-
0 242 245 576	VK22	-
0 242 250 503	W24ESR-U	-
0 242 250 506	W24FSR	-
0 242 250 512	IW24	-
0 242 255 501	IRE01-27	-
0 242 255 502	W27ESR-U	-
0 242 255 504	IW27	-

BOSCH	DENSO	TT
0 242 255 506	IW27	-
0 242 255 511	GK3-1A	-
0 242 255 512	GE3-1	-
0 242 255 518	GK3-1A	-
0 242 260 001	W31ESR-U	-
0 242 319 501	MA16PR-U	-
0 242 325 501	MA16PR-U	-
0 242 329 503	MA16PR-U	-
0 242 329 505	MA16PR-U	-
0 242 335 504	MA20PR-U	-
0 242 340 501	MA20PR-U	-
0 242 356 501	GI3-1	-
0 242 356 502	GT3-1	-
0 242 356 504	GI3-1	-
0 242 356 507	GL3-1	-
0 250 200 049	DG-202	-
0 250 200 053	DG-202	-
0 250 200 054	DG-001	-
0 250 200 057	DG-001	-
0 250 200 058	DG-001	-
0 250 200 059	DG-001	-
0 250 200 060	DG-001	-
0 250 200 063	DG-012	-
0 250 200 064	DG-001	-
0 250 200 065	DG-001	-
0 250 200 066	DG-001	-
0 250 200 068	DG-001	-
0 250 200 069	DG-001	-
0 250 200 469	DG-001	-
0 250 201 001	DG-001	-
0 250 201 004	DG-012	-
0 250 201 005	DG-001	-
0 250 201 006	DG-001	-
0 250 201 008	DG-001	-
0 250 201 009	DG-001	-
0 250 201 010	DG-003	-
0 250 201 011	DG-012	-
0 250 201 012	DG-202	-
0 250 201 014	DG-202	-
0 250 201 015	DG-012	-
0 250 201 017	DG-123	-
0 250 201 019	DG-001	-
0 250 201 021	DG-012	-
0 250 201 026	DG-010	-
0 250 201 027	DG-001	-
0 250 201 030	DG-001	-
0 250 201 031	DG-012	-
0 250 201 032	DG-012	-
0 250 201 033	DG-001	-
0 250 201 034	DG-202	-
0 250 201 035	DG-119	-
0 250 201 037	DG-001	-
0 250 201 038	DG-106	-
0 250 201 039	DG-001	-
0 250 201 041	DG-010	-
0 250 201 042	DG-001	-
0 250 201 043	DG-006	-
0 250 201 046	DG-012	-
0 250 201 047	DG-010	-
0 250 201 048	DG-106	-
0 250 201 049	DG-007	-
0 250 201 050	DG-012	-
0 250 201 053	DG-129	-
0 250 201 054	DG-106	-
0 250 201 055	DG-010	-
0 250 201 405	DG-001	-
0 250 201 415	DG-012	-
0 250 201 469	DG-001	-
0 250 201 933	DG-012	-
0 250 201 946	DG-010	-
0 250 201 950	DG-001	-

BOSCH	DENSO	TT
0 250 201 951	DG-123	-
0 250 201 952	DG-001	-
0 250 201 954	DG-010	-
0 250 202 001	DG-004	-
0 250 202 002	DG-111	-
0 250 202 003	DG-198	-
0 250 202 004	DG-234	-
0 250 202 006	DG-211	-
0 250 202 007	DG-114	-
0 250 202 008	DG-143	-
0 250 202 009	DG-005	-
0 250 202 015	DG-157	-
0 250 202 018	DG-004	-
0 250 202 019	DG-001	-
0 250 202 020	DG-003	-
0 250 202 022	DG-005	-
0 250 202 023	DG-109	-
0 250 202 024	DG-009	-
0 250 202 025	DG-101	-
0 250 202 026	DG-110	-
0 250 202 027	DG-133	-
0 250 202 028	DG-127	-
0 250 202 029	DG-117	-
0 250 202 032	DG-116	-
0 250 202 033	DG-127	-
0 250 202 034	DG-102	-
0 250 202 035	DG-008	-
0 250 202 036	DG-122	-
0 250 202 038	DG-176	-
0 250 202 040	DG-115	-
0 250 202 041	DG-155	-
0 250 202 042	DG-118	-
0 250 202 043	DG-142	-
0 250 202 045	DG-117	-
0 250 202 046	DG-109	-
0 250 202 048	DG-181	-
0 250 202 051	DG-223	-
0 250 202 052	DG-216	-
0 250 202 053	DG-211	-
0 250 202 054	DG-215	-
0 250 202 056	DG-114	-
0 250 202 058	DG-232	-
0 250 202 060	DG-198	-
0 250 202 064	DG-157	-
0 250 202 065	DG-108	-
0 250 202 073	DG-213	-
0 250 202 076	DG-222	-
0 250 202 077	DG-157	-
0 250 202 079	DG-214	-
0 250 202 085	DG-124	-
0 250 202 086	DG-159	-
0 250 202 087	DG-104	-
0 250 202 089	DG-146	-
0 250 202 092	DG-174	-
0 250 202 093	DG-137	-
0 250 202 094	DG-198	-
0 250 202 095	DG-214	-
0 250 202 096	DG-211	-
0 250 202 097	DG-219	-
0 250 202 102	DG-144	-
0 250 202 103	DG-145	-
0 250 202 119	DG-235	-
0 250 202 121	DG-306	-
0 250 202 124	DG-187	-
0 250 202 125	DG-245	-
0 250 202 126	DG-175	-
0 250 202 128	DG-126	-
0 250 202 129	DG-112	-
0 250 202 130	DG-130	-
0 250 202 131	DG-121	-
0 250 202 132	DG-196	-

BOSCH	DENSO	TT
0 250 202 135	DG-181	-
0 250 202 137	DG-302	-
0 250 202 140	DG-110	-
0 250 202 142	DG-117	-
0 250 202 143	DG-182	-
0 250 202 146	DG-197	-
0 250 203 001	DG-170	-
0 250 203 002	DG-171	-
0 250 203 004	DG-140	-
0 250 203 009	DG-195	-
0 250 203 012	DG-614	-
0 250 204 001	DG-113	-
0 250 204 002	DG-180	-
0 250 212 006	DG-173	-
0 250 212 009	DG-005	-
0 250 212 010	DG-212	-
0 250 212 011	DG-602	-
0 250 312 001	DG-307	-
0 250 312 002	DG-304	-
0 250 312 003	DG-300	-
0 250 312 007	DG-301	-
0 250 402 001	DG-177	-
0 250 402 002	DG-178	-
0 250 402 005	DG-177	-
0 250 403 001	DG-610	-
0 250 403 002	DG-190	-
0 250 403 003	DG-604	-
0 250 403 005	DG-608	-
0 250 403 006	DG-194	-
0 250 403 008	DG-194	-
0 250 403 009	DG-193	-
0 250 403 010	DG-604	-
0 250 403 011	DG-608	-
0 250 403 012	DG-609	-
0 250 403 013	DG-619	-
0 250 403 014	DG-621	-
0 250 404 001	DG-603	-
0 250 503 003	DG-601	-
0241219540	W14F-U	-
1	DG-001	-
10	DG-004	-
103	DG-108	-
109	DG-176	-
111	DG-181	-
115	DG-140	-
119	DG-010	-
12	DG-007	-
144	DG-610	-
16	DG-171	-
2	DG-012	-
205	DG-195	-
212	DG-600	-
221	DG-609	-
224	DG-005	-
235	DG-197	-
25	DG-119	-
3	DG-005	-
30	DG-142	-
34	DG-198	-
38	DG-146	-
4	DG-003	-
41	DG-111	-
43	DG-170	-
44	DG-175	-
51	DG-130	-
54	DG-174	-
55	DG-181	-
59	DG-113	-
6	DG-010	-
66	DG-196	-
8	DG-117	-

BOSCH	DENSO	TT
89	DG-001	-
9 240 033 535	W20FPR-U	WF20TT
9 443 612 053	DG-311	-
D 6 BC	MA20P-U	-
D 7 BC	MA20P-U	-
D 8 AC	MA16PR-U	-
D10B	MA16PR-U	-
D10BC	MA16PR-U	-
DR 6 BC	MA20PR-U	-
DR 7 BC	MA20PR-U	-
DR 8 BC	MA16PR-U	-
DR 8 BPX+	MA16PR-U	-
DR 9 BC	MA16PR-U	-
DR10BC	MA16PR-U	-
F 01G 000 00P	DG-600	-
F 01G 004 02U	DG-311	-
F 08 CS	IK31	-
F 09 CS	IK31	-
F 2 CS	IK27	-
F 3 CS	IK27	-
F 4 CS	IK24	-
F 5 DC	K22PR-U	-
F 5 DP 0 R	IK22	-
F 6 DC	K20P-U	K20TT
F 6 DP 0 R	IK20	IK20TT
F 6 DSR	IK20	IK20TT
F 6 DTC	K20PBR	K20TT
F 7 DC	K20P-U	K20TT
F 7 KTCR	K20PBR-S10	K20TT
F 7 LDCR	K20TXR	K20TT
F 7 LTCR	K20PBR-S10	K20TT
F 8 DC	K16PR-U11	K16TT
F 8 DC 4	K16PR-U11	K16TT
F01G00402Z	DG-600	-
F8KTCR	K20PBR-S10	K20TT
FGR 5 KQE0	IK22	-
FGR 6 HQE 0	K20PBR-S10	K20TT
FGR 6 KQE	K20PBR-S10	K20TT
FGR 6 NQE0	K20HR-U11	KH20TT
FGR 7 DQ+	K20PBR-S10	K20TT
FGR 7 DQP+	K20TXR	K20TT
FGR 7 KQE	K20PBR-S10	K20TT
FGR 7 KQE 0	K20PBR-S10	K20TT
FGR 7 MQPE	IKH20	IKH20TT
FGR 8 KQE	K20PBR-S10	K20TT
FGR 8 KQE 0	K20PBR-S10	K20TT
FLR 8 LDCU+	K20TXR	K20TT
FLR 9 LTE	K16TNR-S9	K16TT
FQR 7 ME	K20HR-U11	KH20TT
FQR 8 LE 2	KJ16CR-L11	K16TT
FQR 8 LEU 2	KJ16CR-L11	K16TT
FR 10 DC	K16PR-U	K16TT
FR 10 DCX+	K16PR-U11	K16TT
FR 3 KII 332	GK3-1A	-
FR 5 DC	K22PR-U	-
FR 5 DCX	K22PR-U11	-
FR 5 DP+	IK22	-
FR 5 DPP 222	PK22PR-L11S	-
FR 5 DTC	K22PBR-S	-
FR 5 KPP 332S	VK22	-
FR 5 LDC	K22PBR-S	-
FR 56	IK22	-
FR 6 DC 2	K20PR-U	K20TT
FR 6 DC+	K20PR-U	K20TT
FR 6 DCX	K20PR-U11	K20TT
FR 6 DCX+	K20PR-U11	K20TT
FR 6 DDC	K22TNR-S	-
FR 6 DP+	IK20	IK20TT
FR 6 DPP 22	PQ20R-P8	IQ20TT
FR 6 DPP 22 U	PK20PR11	K20TT
FR 6 DPP 33 X	PK20PR11	K20TT

Spark & Glow Plugs

Cross Reference Chart - Competitor

BOSCH	DENSO	TT
FR 6 DPP 332 S	PK20PR-P8	IK20TT
FR 6 DPX+	IK20	IK20TT
FR 6 DS	IK20	IK20TT
FR 6 KDC	K20TNR-S	K20TT
FR 6 KDC+	K20TNR-S	K20TT
FR 6 KDE 0	K20TXR	K20TT
FR 6 KI 332 S	SK20PR-A8	IK20TT
FR 6 KPP 33 X+	PK20PR-L11	IK20TT
FR 6 KPP 33+	PQ20R-P8	IQ20TT
FR 6 KPP 332 S	VK20	IK20TT
FR 6 KPP 332 U	VK20	IK20TT
FR 6 KTC	K20PBR	K20TT
FR 6 LDC	K20TR11	K20TT
FR 6 LTC	K20PBR	K20TT
FR 6 MPP 332	VKH20	IKH20TT
FR 6 NPP 332	VKH20	IKH20TT
FR 7 DC+	K20PR-U	K20TT
FR 7 DCX+	K20PR-U11	K20TT
FR 7 DE 2	K20PR-U	K20TT
FR 7 DII 35 V	DK20PR-D13	-
FR 7 DP+	IK20	IK20TT
FR 7 DPP 22 U	PK20PR11	K20TT
FR 7 DPP 33	PK20PR-P8	IK20TT
FR 7 DPP 332	VK20	IK20TT
FR 7 DPP+	PK20PR-P8	IK20TT
FR 7 DPX+	IK20	IK20TT
FR 7 HC 0 X	K16GPR-U11	-
FR 7 HC+	KJ16CR-L11	K16TT
FR 7 HPP 33+	PKJ20CR-L11	IK20TT
FR 7 HPP 332 W	VK20	IK20TT
FR 7 KC+	K20R-U	K20TT
FR 7 KCW	K20R-U	K20TT
FR 7 KCX+	K20R-U11	K20TT
FR 7 KI 332 S	VK22	-
FR 7 KII 33 X	VK20	IK20TT
FR 7 KP	IK20	IK20TT
FR 7 KPP 33 U+	VK20	IK20TT
FR 7 KPP 33+	PK20PR-P8	IK20TT
FR 7 KPP 332	VK20	IK20TT
FR 7 KPP 332U	VK20	IK20TT
FR 7 KPX	IK20	IK20TT
FR 7 KTC	K20PBR-S10	K20TT
FR 7 LC 2	KJ20CR-U11	K20TT
FR 7 LCX+	KJ20CR-U11	K20TT
FR 7 LD+	K20TXR	K20TT
FR 7 LDC	K20TXR	K20TT
FR 7 LI 332 S	VKB20	-
FR 7 LPX	IK20	IK20TT
FR 7 MPP 10	VKH20	IKH20TT
FR 7 NI 33	VKH20	IKH20TT
FR 7 NI 332 S	VKH20Y	-
FR 7 NII 33 X	SK20HR11	IKH20TT
FR 7 NII 35 U	FK20HR11	IKH20TT
FR 7 NPP 33	VKH20	IKH20TT
FR 7 NPP 332	VKH20	IKH20TT
FR 7 SE	K20HR-U11	KH20TT
FR 7 SI 30	IKH20	IKH20TT
FR 78 X	VK20	IK20TT
FR 78	VK20	IK20TT
FR 8 D+	K16PR-U	K16TT
FR 8 DCX+	K16PR-U11	K16TT
FR 8 DP	IK16	IK16TT
FR 8 DPP 33+	PK16PR-L11	IK16TT
FR 8 DPX +	IK16	IK16TT
FR 8 DS	IK16	IK16TT
FR 8 HC	QJ16HR-U9	-
FR 8 HDC+	K16TR11	K16TT
FR 8 HP+	QJ16HR-U9	-
FR 8 KC+	K16R-U	K16TT
FR 8 KCU	K16R-U11	K16TT
FR 8 KDC	K16TR11	K16TT

BOSCH	DENSO	TT
FR 8 KI 33 V	SK16PR-E11	IK16TT
FR 8 KI 332 S	K16PSR-B8	IK16TT
FR 8 KTC+	K20PBR-S10	K20TT
FR 8 LC	K20TXR	K20TT
FR 8 LCX	KJ16CR-L11	K16TT
FR 8 LPX+	PKJ16CR-L11	IK16TT
FR 8 ME	K16HPR-U11	KH16TT
FR 8 MII 33 X	SK16HR11	IKH16TT
FR 8 NP	IKH16	IKH16TT
FR 8 SC+	K16HPR-U11	KH16TT
FR 8 SE 0	K16HPR-U11	KH16TT
FR 8 SPP 332	VKH16	IKH16TT
FR 9 DC	Q14R-U11	IQ16TT
FR 9 DCX	Q14R-U11	IQ16TT
FR 9 HC+	QJ16HR-U9	-
FR 9 LCX	KJ16CR-L11	K16TT
FR 91	K16TNR-S9	K16TT
FR3CII360	GK3-1A	-
FR6DTC	K20PBR	K20TT
FR7DE	K20PR-U	K20TT
GLP001	DG-001	-
GLP002	DG-012	-
GLP003	DG-005	-
GLP004	DG-003	-
GLP006	DG-010	-
GLP008	DG-117	-
GLP010	DG-004	-
GLP012	DG-007	-
GLP016	DG-171	-
GLP019	DG-118	-
GLP021	DG-110	-
GLP023	DG-109	-
GLP025	DG-119	-
GLP030	DG-142	-
GLP033	DG-109	-
GLP034	DG-198	-
GLP038	DG-146	-
GLP040	DG-145	-
GLP041	DG-111	-
GLP042	DG-211	-
GLP043	DG-170	-
GLP044	DG-175	-
GLP051	DG-130	-
GLP054	DG-174	-
GLP055	DG-181	-
GLP059	DG-113	-
GLP066	DG-196	-
GLP070	DG-178	-
GLP074	DG-214	-
GLP078	DG-133	-
GLP089	DG-001	-
GLP092	DG-302	-
GLP093	DG-190	-
GLP094	DG-180	-
GLP103	DG-108	-
GLP109	DG-176	-
GLP111	DG-181	-
GLP115	DG-140	-
GLP119	DG-010	-
GLP120	DG-159	-
GLP125	DG-157	-
GLP132	DG-219	-
GLP137	DG-187	-
GLP144	DG-610	-
GLP147	DG-601	-
GLP158	DG-010	-
GLP179	DG-604	-
GLP196	DG-608	-
GLP197	DG-194	-
GLP202	DG-194	-
GLP203	DG-173	-

BOSCH	DENSO	TT
GLP205	DG-195	-
GLP210	DG-614	-
GLP212	DG-600	-
GLP221	DG-609	-
GLP223	DG-212	-
GLP224	DG-005	-
GLP225	DG-182	-
GLP235	DG-197	-
GLP2-4	DG-614	-
GLP2-5	DG-182	-
GLP2-5/4.5	DG-212	-
GLP2-HS	DG-190	-
GLP2-HS	DG-193	-
GLP2-HS	DG-610	-
GSK2	DG-178	-
H 2 CS	IT27	-
H 3 CS	IT24	-
H 4 CS	IT24	-
H 56	T22EP-U	-
H 6 DC	T20EPR-U	T20TT
H 7 DC	T20EPR-U	T20TT
H 8 DC	T16EPR-U	T16TT
H 9 DC 0	T16EPR-U	T16TT
H6DP	T20EPR-U	T20TT
HGR 6 KQC	T20EPR-U	T20TT
HGR 7 KQC	T20EPR-U	T20TT
HGR 8 MQI	ITV16	ITV16TT
HLR 8 STEX	PT16VR13	TV16TT
HR 10 ACY	T14PR-U	ITF16TT
HR 10 BC+	T14PR-U	ITF16TT
HR 10 BCX	T14PR-U	ITF16TT
HR 10 BCY+	T14PR-U	ITF16TT
HR 10 BCZ	T14PR-U	ITF16TT
HR 10 HC 0	T16EPR-U	T16TT
HR 10 HC+	T16EPR-U	T16TT
HR 5 DC	T22EP-U	-
HR 6 BC	T20PR-U	ITF20TT
HR 6 D+	T20EPR-U	T20TT
HR 6 DP+	T20EPR-U	T20TT
HR 6 DPP 33 V	ZT20EPR11	T20TT
HR 6 DS	T20EPR-U	T20TT
HR 7 D+	T20EPR-U	T20TT
HR 7 DCX+	T20EPR-U	T20TT
HR 7 DCY+	T20EPR-U15	T20TT
HR 7 DP+	IT20	IT20TT
HR 7 DPX	IT20	IT20TT
HR 7 KPP 33+	ZT20EPR11	T20TT
HR 7 MPP 302	PT16VR13	TV16TT
HR 7 MPP+V	PT16VR13	TV16TT
HR 7 NI 332 W	ITV20	ITV20TT
HR 78 X	VT20	IT20TT
HR 78	VT20	IT20TT
HR 8 AC	T20R-U	-
HR 8 BC	T16PR-U	ITF16TT
HR 8 BCY	T16PR-U15	ITF16TT
HR 8 D+	T20EPR-U	T20TT
HR 8 DCV+	T16EPR-U	T16TT
HR 8 DCX+	T16EPR-U	T16TT
HR 8 DCY	T16EPR-U15	T16TT
HR 8 DP	IT16	IT16TT
HR 8 DP V	IT16	IT16TT
HR 8 DP X+	IT16	IT16TT
HR 8 DPP 15 V	PT16EPR-L13	IT16TT
HR 8 DPP 22 U	PT16EPR-L13	IT16TT
HR 8 MCV+	T16VR-U10	TV16TT
HR 8 MEV	T16VR-U10	TV16TT
HR 8 MPV	PT16VR13	TV16TT
HR 8 NI 332 W	ITL16	ITL16TT
HR 8 NPP 302	PT16VR13	TV16TT
HR 9 BC+	T16PR-U	ITF16TT
HR 9 BCY+	T16PR-U15	ITF16TT

BOSCH	DENSO	TT
HR 9 DC	T16EPR-U	T16TT
HR 9 DC+	T16EPR-U	T16TT
HR 9 DCX	T16EPR-U15	T16TT
HR 9 DCX+	T16EPR-U15	T16TT
HR 9 DCY+	T16EPR-U15	T16TT
HR 9 HC+	T20NR-U11	IT20TT
HR 9 HCO	T20NR-U11	IT20TT
HR 9 KII 33 Y	VT16	IT16TT
HR 9 LPP 22 Y	PTJ16R15	IT16TT
HR 9 SE0X	ITL16	ITL16TT
HR 91 GX	T16PR-U	ITF16TT
HS 5 E	T22M-U	-
HS 6 E	T22M-U	-
HS 7 E	T20M-U	-
HS 7 F	T20MP-U	-
HS 8 E	T20M-U	-
M 10 AC	L14-U	-
M 12 B	L14-U	-
M 4 AC	M24S	-
M 5 AC	M22	-
M 7 AC	M17	-
M 8 AC	L14-U	-
MR3BPP330	GT3-1	-
MR3DII330	GL3-1	-
MR3DPP33	GI3-1	-
MR3DPP330	GI3-1	-
U 3 CC	U22ESR-N	-
U 4 AC	U22FSR-U	-
U 5 AC	U20FSR-U	-
U 6 AC	U20FSR-U	-
UR 2 CC	U24ESR-N	-
UR 3 AC	U22FSR-U	-
UR 3 CC	U22ESR-N	-
UR 4 AC	U22FSR-U	-
UR 6 AC	U20FSR-U	-
UR 6 DE	IU22	-
UR 6 NE	XE20HR-U9	IKXH20TT
VR 7 NII 33 X	SC20HR11	IKXH22TT
VR 7 SPP 33	FXE20HE11	IKXH20ETT
VR 7 TII 35 U	FXE20HE11	IKXH20ETT
VR 8 NII 35 U	FXE20HR11	IKXH20TT
VR 8 SC+	XE20HR-U9	IKXH20TT
VR 8 SE 0	XE20HR-U9	IKXH20TT
VR 8 SEW	XE20HR-U9	IKXH20TT
W 06 CS	IW34	-
W 07 AS	W31FS	-
W 07 CS	IW34	-
W 08 AS	IWF27	-
W 08 CS	IW31	-
W 10 AC	W14F-U	-
W 10 CC	W14E	-
W 10 DC	W9EP	-
W 10 EC	W14PR-U	-
W 2 AC	W27FSR	-
W 2 AS	IWF27	-
W 2 CC	W27ESR-U	-
W 2 CS	IW31	-
W 3 AC	W24FSR	-
W 3 CC	W24ESR-U	-
W 3 CS	IW24	-
W 3 DP 0	IW24	-
W 4 AC	W24FSR	-
W 4 AS	IWF24	-
W 4 CC	W24ESR-U	-
W 4 CS	IW24	-
W 4 DP 0	IW24	-
W 5 AC	W22FS-U	-
W 5 AS	IWF22	-
W 5 CC	W22ESR-U	-
W 5 DP 0	IW24	-
W 6 AC	W20FSR-U	WF20TT

Spark & Glow Plugs

Cross Reference Chart - Competitor

BOSCH	DENSO	TT
W 6 CC	W22ESR-U	-
W 6 DC	W20EP-U	W20TT
W 7 AC	W20FSR-U	WF20TT
W 7 BC	W20FPR-U	WF20TT
W 7 CC	W20ESR-U	-
W 7 DC	W20EPR-U	W20TT
W 7 DCX	W20EPR-U11	W20TT
W 7 DSR	W20EPB	W20TT
W 7 DTC	W20EPB	W20TT
W 7 EC	W20S-U	-
W 7 FC	W20PR-U	-
W 7 LTCR	W20EPBR-S	W20TT
W 8 AC	W16FSR	-
W 8 BC	W16FPR-U	-
W 8 CC	W16ESR-U	-
W 8 DC	W16EPR-U	W16TT
W 8 DTC	W20EPB	W20TT
W 8 EC	W16S-U	-
W 9 AC	W14F-U	-
W 9 CC	W14E	-
W 9 DC	W14EPR-U	W16TT
W 9 EC	W14PR-U	-
W 9 EC 0	W14LM-U	-
W 9 LDCR	W16ETR-S	W16TT
W5DC	W22EPR-U	W22TT
WEA	SF-50	-
WR 10 AC	W14FR-U	-
WR 10 DC	W14EPR-U	W16TT
WR 10 DCX	W14EXR-U11	W16TT
WR 10 FC	W14PR-U	-
WR 10 FCY	W14PR-U	-
WR 10 FCZ+	W14PR-U	-
WR 10 LC+	J16CR-U	W16TT
WR 10 LCV	J16CR-U	W16TT
WR 10 LCV+	J16CR-U	W16TT
WR 11 E 0	W9LMR-US	-
WR 11 F	W9PR-U	-
WR 12 EC	W9LMR-US	-
WR 2 CC	W31ESR-U	-
WR 3 CC	W27ESR-U	-
WR 3 CP+	IW27	-
WR 3 CS	IW27	-
WR 3 CTC	IRE01-27	-
WR 4 AC	W24FSR	-
WR 4 CC	W24ESR-U	-
WR 4 DP 0	IW24	-
WR 5 AC	W22FSR	-
WR 5 AP+	IWF22	-
WR 5 CC	W22ESR-U	-
WR 5 D+	W22EPR-U	W22TT
WR 5 DP+	IW22	-
WR 5 DS	IW22	-
WR 56	VW22	-
WR 6 AC	W22FSR	-
WR 6 BC	W20FPR-U	WF20TT
WR 6 CC	W22ESR-U	-
WR 6 D+	W20EPR-U	W20TT
WR 6 DCX	W20EPR-U11	W20TT
WR 6 DP 0	IW20	W20TT
WR 6 DP+	IW20	W20TT
WR 6 DS	IW20	W20TT
WR 7 AC	W20FSR-U	WF20TT
WR 7 AP+	IWF22	-
WR 7 B+	W20FPR-U	WF20TT
WR 7 BP+	IWF22	-
WR 7 CC	W20ESR-U	-
WR 7 CE	W20ESR-U	-
WR 7 CP+	W20ESR-U	-
WR 7 D+	W20EPR-U	W20TT
WR 7 DCX+	W20EPR-U11	W20TT
WR 7 DP+	IW20	W20TT

BOSCH	DENSO	TT
WR 7 DPX+	IW20	IW20TT
WR 7 DS	IW20	IW20TT
WR 7 DTC	W20EPBR-S	W20TT
WR 7 EC	W20SR-U	-
WR 7 KI 33 S	IW20	IW20TT
WR 7 LC	J16CR-U	W16TT
WR 7 LTC+	W20EPBR-S	W20TT
WR 78 G	IWF20	-
WR 78 X	W20EPBR-S	W20TT
WR 78	W20EPBR-S	W20TT
WR 8 AC	W16FSR	-
WR 8 AP+	W16FSR	-
WR 8 B+	W16FPR-U	-
WR 8 BC+	W16FPR-U	-
WR 8 CC	W16ESR-U	-
WR 8 CP+	W16ESR-U	-
WR 8 D+	W16EPR-U	W16TT
WR 8 D+X	W16EPR-U11	W16TT
WR 8 DC+	W16EPR-U	W16TT
WR 8 DP+	IW16	IW16TT
WR 8 DPX+	IW16	IW16TT
WR 8 DS	W16EPR-U	W16TT
WR 8 FC	W16PR-U	-
WR 8 LC+	J16CR-U	W16TT
WR 8 LP+	IW16	IW16TT
WR 8 LT+	W20EPBR-S	W20TT
WR 9 D+	W16EPR-U	W16TT
WR 9 DCX+	W14EXR-U11	IW16TT
WR 9 DP+	W14EPR-U	IW16TT
WR 9 DPX+	W14EXR-U11	IW16TT
WR 9 DS	W14EPR-U	IW16TT
WR 9 FP	W16PR-U	-
WR 9 HC	J16AR-U11	-
WR 9 LCX+	J16CR-U	W16TT
WR 9 LE	J16CR-U	W16TT
WR 9 LEV+	J16CR-U	W16TT
WR 9 LS	J16CR-U	W16TT
WR 91 X	VW16	IW16TT
WR 91	VW16	IW16TT
WR3CPP33	GE3-1	-
WR7D+X	W20EPR-U11	W20TT
WS 12 E	W14MR-U	-
WS 5 E	W22M-U	-
WS 5 F	W22MPR-U	-
WS 6 E	W20MR-U	-
WS 6 F	W20MP-U	-
WS 7 E	W20MR-U	-
WS 8 E	W20MR-U	-
WS 8 F	W20MP-U	-
WS 9 EC	W14MR-U	-
WSR 5 F	W22MPR-U	-
WSR 6 E	W20MR-U	-
WSR 6 F	W22MPR-U	-
WSR 7 F	W20MPR-U10	-
WSR 8 E	W14MR-U	-
X 4 CC	X24ESR-U	-
X 4 DC	X27EPR-U9	-
X 5 DC	X22EPR-U9	-
X 5 DTC	X22ESR-U	-
XR 2 CS	IX24	-
XR 4 CS	X24ESR-U	-
XR 5 DC	X22EPR-U9	-
XR 6 CC	X24ESR-U	-
XR 7 DC	X22EPR-U9	-
XR 8 DC	X20EPR-U9	-
Y 5 DDC	XU22EPR-U	XU22TT
Y 6 DC	XU20EPR-U	-
YR 5 DDE	XU24EPR-U	-
YR 5 LDE	XU24EPR-U	-
YR 5 NI 332 S	SXU22HDR8	-
YR 6 DES	XU22PR9	XU22TT

BOSCH	DENSO	TT
YR 6 LDE	XU22EPR-U	XU22TT
YR 6 NI 332 S	SXU22HDR8	-
YR 6 NPP 332	VXUH22	-
YR 7 DC+	XU22EPR-U	XU22TT
YR 7 DE	XU22EPR-U	XU22TT
YR 7 LPP 332 W	VXU22	-
YR 7 MPP 33	SXU22HDR8	-
YR 7 NE	XU22HDR9	XUH22TT
YR 8 SEU	XU22HDR9	XUH22TT
ZQR 8 SI 302	VXUH22	-
ZR 7 SI 332 S	VXUH22	-

BRISKAL	DENSO	TT
B12YC	X27EPR-U9	-
B14YC	X24EPR-U9	-
B15YC	X22EPR-U9	-
D12Y	IK24	-
D12YC	IK24	-
D14Y	Q22PR-U	-
D14YC	Q22PR-U	-
D15YC	Q20PR-U	Q20TT
D17Y	Q16PR-U	Q16TT
D17YC	Q16PR-U	Q16TT
DOR08LGS	IK31	-
DOR08TS	IK31	-
DOR10LGS	IK27	-
DOR10TS	IK27	-
DOR11LGS	IK27	-
DOR12LGS	IK24	-
DOR12TS	IK24	-
DOX15LE1	KJ16CR-L11	K16TT
DR12YC	Q22PR-U	-
DR12ZC	IK22	-
DR14TC	K22PBR-S	-
DR14TC1	K22PBR-S	-
DR14YC	Q22PR-U	-
DR14YPP1	IK22	-
DR14YS	IK22	-
DR14ZC	IK20	IK20TT
DR14ZC1	IK20	IK20TT
DR15LTC1	K20PBR-S10	K20TT
DR15TC	K20PBR	K20TT
DR15TCY1	K20PBR-S10	K20TT
DR15YC	Q20PR-U	Q20TT
DR15YC1	Q20PR-U11	Q20TT
DR15YPP1	IK20	IK20TT
DR15ZC	IK20	IK20TT
DR15ZC1	IK20	IK20TT
DR17TC	K20PBR-S10	K20TT
DR17TCY	K16TNR-S9	K16TT
DR17YC	Q16PR-U	Q16TT
DR17YPP1	IK16	IK16TT
DR17YS	IK16	IK16TT
DX14LTC1	K22PBR-S	-
DX14TC	K22PB	-
DX15LTC1	K20PBR-S10	K20TT
DX15TC	K20PBR	K20TT
DX17LTC1	K20PBR-S10	K20TT
DX17TC	K20PBR-S10	K20TT
F15YC	MA20P-U	-
FR15YC	MA20PR-U	-
G12YC	T22EP-U	-
G14Y	T22EP-U	-
G14YC	T22EP-U	-
G15Y	T20EPR-U	T20TT
G15YC	T20EPR-U	T20TT
G17Y	T16EPR-U	T16TT
G17YC	T16EPR-U	T16TT
GR12YC	T22EP-U	-
GR12ZC	T22EP-U	-
GR14YC	T22EP-U	-

BRISKAL	DENSO	TT
GR14ZC	T20EPR-U	T20TT
GR14ZC1	T20EPR-U15	T20TT
GR15YC	T20EPR-U	T20TT
GR15ZC	T16EPR-U	T16TT
GR15ZC1	T16EPR-U15	T16TT
GR17YC	T16EPR-U	T16TT
J17	W14LM-US	-
J19	W9LM-US	-
JR17	W14LM-U	-
JR19	W9LMR-US	-
K15YC	W20PR-U	-
K17C	W16S-U	-
K17Y	W16PR-U	-
K19	W14PR-U	-
LO8JW	IW34	-
LO8S	IW34	-
LO8W	IW01-34	-
L10JW	IW29	-
L12W	IW27	-
L12Y	W24EPR-U	-
L12YC	W24EPR-U	-
L14C	W22ESR-U	-
L14U	W22ESR-U	-
L14Y	W22EPR-U	W22TT
L14YC	W22EPR-U	W22TT
L15	W20ESR-U	-
L15C	W20ESR-U	-
L15W	IW24	-
L15Y	W20EP-U	W20TT
L15YC	W20EP-U	W20TT
L17	W16ESR-U	-
L17C	W16ESR-U	-
L17W	IW20	IW20TT
L17Y	W16EPR-U	W16TT
L17YC	W16EPR-U	W16TT
L19	W14E	-
LOR08LGS	IW31	-
LOR08TS	IW31	-
LOR10LGS	IW27	-
LOR10TS	IW27	-
LOR12LGS	IW24	-
LOR12TS	IW24	-
LR12S	IW24	-
LR12YC	W24EPR-U	-
LR12ZC	IW22	-
LR14YC	W22EPR-U	W22TT
LR14YPP	IW22	-
LR14YS	IW22	-
LR14ZC	IW20	IW20TT
LR14ZC1	IW20	IW20TT
LR15TC	W20EPBR-S	W20TT
LR15YC	W20EPR-U	W20TT
LR15YC1	W20EPR-U11	W20TT
LR15YS	IW20	IW20TT
LR15ZC	IW20	IW20TT
LR15ZC1	IW20	IW20TT
LR17TC	W20EPBR-S	W20TT
LR17TC1	W20EPBR-S	W20TT
LR17YC	W16EPR-U	W16TT
LR17YS	IW16	IW16TT
LX14TC	W22EPB	W22TT
LX15LTC1	W20EPBR-S	W20TT
LX15TC	W20EPB	W20TT
LX15TC1	W20EPB	W20TT
LX17LTC1	W20EPBR-S	W20TT
LX17TC	W16EPB10	W16TT
LX17TC1	W16EPB10	W16TT
N12W	IWF27	-
N14	W22FS-U	-
N14C	W22FS-U	-
N14Y	W22FPR-U	-

Spark & Glow Plugs

Cross Reference Chart - Competitor

BRISKAL	DENSO	TT
N14YC	W22FPR-U	-
N15	W20FSR-U	WF20TT
N15C	W20FSR-U	WF20TT
N15W	IWF22	-
N15Y	W20FPR-U	WF20TT
N15YC	W20FPR-U	WF20TT
N17	W16FSR	-
N17C	W16FSR	-
N17W	IWF22	-
N17YC	W16FPR-U	-
N19	W14F-U	-
N19C	W16FSR	-
NR12S	W27FSR	-
NR12YC	W24FPR	-
NR14	W22FSR	-
NR14YC	W22FPR-U	-
NR15	W20FSR-U	WF20TT
NR15YC	W20FPR-U	WF20TT
NR17	W16FSR	-
NR17C	W16FSR	-
NR17YC	W16FPR-U	-
NR19	W14FR-U	-
P15	W22M-U	-
P15Y	W22MPR-U	-
P17	W20M-US	-
P17Y	W20MP-U	-
PR15Y	W22MPR-U	-
PR17Y	W20MPR-U10	-
U15	T22M-U	-
U17	T20M-U	-
UR15	T22M-U	-
UR17	T20M-U	-

CHAMPION	DENSO	TT
10R12A	IK20	IK20TT
1L45JR	IW22	-
1L4J	W20EPR-U	W20TT
1L4JR	W20EPR-U	W20TT
206	IK20	IK20TT
207	IK22	-
208	IK24	-
248814	IW22	-
3013	T16EPR-U15	T16TT
3015	T16EPR-U	T16TT
3018	T16PR-U11	ITF16TT
3031	W16EXR-U13	W16TT
3034	IK16	IK16TT
307	IW22	-
3071	Q16PR-U	Q16TT
3401	T16EPR-U	T16TT
3405	W16EXR-U	W16TT
3407	T16EPR-U15	T16TT
3415	W20EPR-U	W20TT
470	ITL20	-
4VLSR	W20EPR-U	W20TT
5834 (EZstart)	W14M-U	-
5846	T20M-U	-
7015	VT16	IT16TT
7018	ITF16	ITF16TT
7032	PT16VR13	TV16TT
7034	J16AR-U11	-
7318	VK16	IK16TT
7436	VK16	IK16TT
7440	ITL20	-
7712	MA20PR-U	-
7940	VT16	IT16TT
7983	VT16	IT16TT
7FYS	IW22	-
7FYSR	IW22	-
7FYSSR	IW22	-
7GBMSR	K22PBR-S	-

CHAMPION	DENSO	TT
7GBYSR4	K22PBR-S	-
7GYSSR	Q22PR-U	-
82CYS	W22FPR-U	-
860	MA20PR-U	-
870	MA16PR-U	-
9001	VK16	IK16TT
9002	VK16	IK16TT
9204	VT20	IT20TT
9401	VT16	IT16TT
9402	VT20	IT20TT
9404	VT16	IT16TT
942M	PKJ16CR-L11	IK16TT
952M	PKJ16CR-L11	IK16TT
955	XU24EPR-U	-
9701	VXU22	-
9801	VK20Y	-
9802	VK20	IK20TT
9803	VK20	IK20TT
9804	IW20	IW20TT
9805	SK20PR-L9	IK20TT
9806	SK20R11	IK20TT
9808	VT20	IT20TT
9901	ITV16	ITV16TT
9FYS	W20EPR-U	W20TT
9FYSR	W20EPR-U	W20TT
9FYSSR	W20EPR-U	W20TT
9GYSR	IK20	IK20TT
9GYSSR	K20PR-U	K20TT
A10	X20ESR-U	-
A2HC	X27ESR-U	-
A49GC	IXU27	-
A4HC	XU27EPR-U	-
A504R	IXU01-34	-
A506R	IXU01-34	-
A51R	IXU01-34	-
A52R	IXU01-34	-
A53C	IXU01-34	-
A53R	IXU01-34	-
A53V	IXU01-34	-
A54R	IXU01-31	-
A55C	IXU01-34	-
A55G	IXU01-34	-
A55R	IXU01-31	-
A57C	X31ESR-U	-
A57C-TT/003	X31ESR-U	-
A57G	IXU01-31	-
A57R	IXU01-31	-
A59C	X27ESR-U	-
A59G	IXU27	-
A59GC	IXU27	-
A5HC	X24ESR-U	-
A5YC	X27EPR-U9	-
A6	X24ESR-U	-
A61	X27ESR-U	-
A61G	IX27	-
A6G	IX24	-
A6GC	IX24	-
A6GHC	IX24B	-
A6HC	X24EPR-U9	-
A6Y	X24EPR-U9	-
A6YC	X24ESR-U	-
A7HC	X22ESR-U	-
A8	X22ESR-U	-
A85Y	X24EPR-U9	-
A8HC	X22EPR-U9	-
A8Y	X24ESR-U	-
A8YC	X22EPR-U9	-
BL11Y	T20PR-U	ITF20TT
BL13Y	T16PR-U	ITF16TT
BL15Y	T16PR-U	ITF16TT
BL6	ITF24	-

CHAMPION	DENSO	TT
BL60	ITF27	-
BL60Y	ITF27	-
BL8	T20R-U	-
BL9Y	T20PR-U	ITF20TT
BN12Y	T16EPR-U	T16TT
BN14Y	T16EPR-U	T16TT
BN2	IT27	-
BN3	IT27	-
BN5	T22EP-U	-
BN59	IT27	-
BN60	IT27	-
BN60Y	IT27	-
BN63Y	IT24	-
BN6Y	T22EP-U	-
BN7Y	T22EP-U	-
BN89Y	T20EPR-U	T20TT
BN9Y	T20EPR-U	T20TT
C10YCC	K20P-U	K20TT
C10YCX	K20P-U	K20TT
C11YCC	Q16PR-U	Q16TT
C12YCC	K16PR-U11	K16TT
C279YC	K22PR-U	-
C281YC	K20P-U	K20TT
C501R	IK02-31	-
C502R	IK02-31	-
C503R	IK02-27	-
C53A	IK01-34	-
C53C	IK31	-
C53VC	IW34	-
C55A	IK01-31	-
C55C	IK31	-
C55JC4	IK01-31	-
C55R	IK02-31	-
C55VC	IW31	-
C57	IK01-31	-
C57A	IK01-31	-
C57C	IK31	-
C57CX	IK31	-
C57JC4	IK01-31	-
C57R	IK02-31	-
C57VC	IW31	-
C57Y	IK31	-
C57YC	IK31	-
C59A	IK01-27	-
C59C	IK27	-
C59CX	IK27	-
C59JC4	IK01-27	-
C59R	IK02-27	-
C59Y	IK27	-
C59YC	IK27	-
C61	IK27	-
C61C	IK27	-
C61YC	IK27	-
C63	IK24	-
C63C	IK24	-
C63YC	IK24	-
C63YCC	K24PR-U11	-
C6BMC	K22PBR-S	-
C6BYC	K22PB	-
C6BYC4	K22PB	-
C6VPYC	IK22	-
C6YC	Q22PR-U	-
C6YCC	K22PR-U	-
C6YCX	K22PR-U	-
C7BMC	K22PBR-S	-
C7GY	IK22	-
C7Y	Q22PR-U	-
C7YC	K22PR-U	-
C7YCC	K22PR-U	-
C7YCX	K22PR-U	-
C9BMC	K20TXR	K20TT

CHAMPION	DENSO	TT
C9BYC	K20PBR	K20TT
C9GY	IK20	IK20TT
C9MCC	KJ16GR-U11	K16TT
C9Y	Q20PR-U	Q20TT
C9YC	K20P-U	K20TT
C9YC4	K20PR-U11	K20TT
C9YCC	K20P-U	K20TT
C9YCX	K20P-U	K20TT
CH101	DG-162	-
CH101/002	DG-162	-
CH103	DG-211	-
CH103/002	DG-211	-
CH110	DG-143	-
CH110/002	DG-143	-
CH121	DG-234	-
CH121/002	DG-234	-
CH132	DG-215	-
CH132/002	DG-215	-
CH133	DG-232	-
CH133/002	DG-232	-
CH137	DG-001	-
CH137/002	DG-001	-
CH147	DG-004	-
CH147/002	DG-004	-
CH154	DG-211	-
CH154/002	DG-211	-
CH156	DG-010	-
CH156/002	DG-010	-
CH157	DG-124	-
CH157/002	DG-124	-
CH158	DG-104	-
CH158/002	DG-104	-
CH159	DG-001	-
CH159/002	DG-001	-
CH160	DG-012	-
CH160/002	DG-012	-
CH161	DG-157	-
CH161/002	DG-157	-
CH162	DG-198	-
CH162/002	DG-198	-
CH163	DG-001	-
CH163/002	DG-001	-
CH164	DG-001	-
CH164/002	DG-001	-
CH166	DG-127	-
CH166/002	DG-127	-
CH167	DG-102	-
CH167/002	DG-102	-
CH168	DG-003	-
CH168/002	DG-003	-
CH169	DG-101	-
CH169/002	DG-101	-
CH170	DG-116	-
CH170/002	DG-116	-
CH171	DG-005	-
CH171/002	DG-005	-
CH172	DG-101	-
CH172/002	DG-101	-
CH173	DG-006	-
CH173/002	DG-006	-
CH174	DG-001	-
CH174/002	DG-001	-
CH175	DG-119	-
CH175/002	DG-119	-
CH176	DG-010	-
CH176/002	DG-010	-
CH177	DG-106	-
CH177/002	DG-106	-
CH178	DG-115	-
CH178/002	DG-115	-
CH179	DG-012	-

CHAMPION	DENSO	TT
CH179/002	DG-012	-
CH180	DG-176	-
CH180/002	DG-176	-
CH181	DG-109	-
CH181/002	DG-109	-
CH184	DG-005	-
CH184/002	DG-005	-
CH185	DG-003	-
CH185/002	DG-003	-
CH186	DG-137	-
CH186/002	DG-137	-
CH187	DG-137	-
CH187/002	DG-137	-
CH188	DG-159	-
CH188/002	DG-159	-
CH189	DG-001	-
CH189/002	DG-001	-
CH190	DG-133	-
CH190/002	DG-133	-
CH196	DG-121	-
CH196/002	DG-121	-
CH200	DG-113	-
CH200/002	DG-113	-
CH201	DG-180	-
CH201/002	DG-180	-
CH203	DG-145	-
CH203/002	DG-145	-
CH204	DG-110	-
CH204/002	DG-110	-
CH205	DG-007	-
CH205/002	DG-007	-
CH206	DG-009	-
CH206/002	DG-009	-
CH207	DG-118	-
CH207/002	DG-118	-
CH208	DG-161	-
CH208/002	DG-161	-
CH209	DG-129	-
CH209/002	DG-129	-
CH210	DG-502	-
CH210/002	DG-502	-
CH215	DG-144	-
CH215/002	DG-144	-
CH216	DG-111	-
CH216/002	DG-111	-
CH217	DG-008	-
CH217/002	DG-008	-
CH218	DG-117	-
CH218/002	DG-117	-
CH219	DG-155	-
CH219/002	DG-155	-
CH221	DG-198	-
CH221/002	DG-198	-
CH222	DG-122	-
CH222/002	DG-122	-
CH223	DG-171	-
CH223/002	DG-171	-
CH224	DG-170	-
CH224/002	DG-170	-
CH225	DG-172	-
CH225/002	DG-172	-
CH226	DG-173	-
CH226/002	DG-173	-
CH227	DG-186	-
CH227/002	DG-186	-
CH228	DG-184	-
CH228/002	DG-184	-
CH229	DG-130	-
CH229/002	DG-130	-
CH230	DG-197	-
CH230/002	DG-197	-

CHAMPION	DENSO	TT
CH231	DG-142	-
CH231/002	DG-142	-
CH232	DG-126	-
CH232/002	DG-126	-
CH233	DG-112	-
CH233/002	DG-112	-
CH234	DG-189	-
CH234/002	DG-189	-
CH238	DG-175	-
CH238/002	DG-175	-
CH239	DG-139	-
CH239/002	DG-139	-
CH240	DG-140	-
CH240/002	DG-140	-
CH242	DG-146	-
CH242/002	DG-146	-
CH252	DG-240	-
CH252/002	DG-240	-
CH255	DG-702	-
CH255/002	DG-702	-
CH256	DG-174	-
CH256/002	DG-174	-
CH258	DG-245	-
CH258/002	DG-245	-
CH260	DG-502	-
CH260/002	DG-502	-
CH263	DG-187	-
CH263/002	DG-187	-
CH268	DG-181	-
CH268/002	DG-181	-
CH269	DG-196	-
CH269/002	DG-196	-
CH270	DG-195	-
CH270/002	DG-195	-
CH271	DG-005	-
CH271/002	DG-005	-
CH272	DG-182	-
CH272/002	DG-182	-
CH273	DG-188	-
CH273/002	DG-188	-
CH275	DG-183	-
CH275/002	DG-183	-
CH306	DG-108	-
CH306/002	DG-108	-
CH406	DG-601	-
CH409	DG-312	-
CH60	DG-012	-
CH60/002	DG-012	-
CH600	DG-304	-
CH600/002	DG-304	-
CH601	DG-300	-
CH601/002	DG-300	-
CH602	DG-301	-
CH602/002	DG-301	-
CH603	DG-302	-
CH603/002	DG-302	-
CH604	DG-312	-
CH604/002	DG-312	-
CH607	DG-306	-
CH607/002	DG-306	-
CH608	DG-305	-
CH608/002	DG-305	-
CH613	DG-307	-
CH613/002	DG-307	-
CH614	DG-311	-
CH614/002	DG-311	-
CH62	DG-202	-
CH62/002	DG-202	-
CH63	DG-001	-
CH63/002	DG-001	-
CH68	DG-001	-

CHAMPION	DENSO	TT
CH68/002	DG-001	-
CH69	DG-001	-
CH69/002	DG-001	-
CH70	DG-202	-
CH70/002	DG-202	-
CH700	DG-177	-
CH700/002	DG-177	-
CH701	DG-178	-
CH701/002	DG-178	-
CH702	DG-190	-
CH702/002	DG-190	-
CH703	DG-191	-
CH703/002	DG-191	-
CH704	DG-192	-
CH704/002	DG-192	-
CH705	DG-193	-
CH705/002	DG-193	-
CH709	DG-194	-
CH709/002	DG-194	-
CH79	DG-123	-
CH79/002	DG-123	-
CH800	DG-608	-
CH800/002	DG-608	-
CH802	DG-604	-
CH802/002	DG-604	-
CH803	DG-603	-
CH803/002	DG-603	-
CH806	DG-602	-
CH806/002	DG-602	-
CH809	DG-601	-
CH809/002	DG-601	-
CH810	DG-600	-
CH810/002	DG-600	-
CH813	DG-607	-
CH813/002	DG-607	-
CH814	DG-605	-
CH814/002	DG-605	-
CH819	DG-606	-
CH819/002	DG-606	-
CH87	DG-001	-
CH87/002	DG-001	-
CH90	DG-132	-
CH90/002	DG-132	-
CH94	DG-198	-
CH94/002	DG-198	-
CH97	DG-114	-
CH97/002	DG-114	-
CJ11	W14M-U	-
CJ14	W14M-U	-
CJ3	W22M-U	-
CJ4	W22M-U	-
CJ6	W22M-U	-
CJ6Y	W22MPR-U	-
CJ7Y	W22MPR-U	-
CJ8	W20MR-U	-
CJ8Y	W20MP-U	-
D10	M17	-
D14/013	L14-U	-
D14N	L14-U	-
D15Y	L14-U	-
D16	L14-U	-
D16J	L14-U	-
D18Y	L14-U	-
D21	L14-U	-
D23	L14-U	-
D6	M24S	-
D78Y	M24S	-
D9/013	M22	-
D9J	M22	-
DJ6J	T22M-U	-
DJ6Y	T22MP-U	-

CHAMPION	DENSO	TT
DJ7J	T20M-U	-
DJ7Y	T20MP-U	-
DJ8J	T20M-U	-
E54R	IW31	-
E57R	IW27	-
EON3/286	T20EPR-U	T20TT
EON3/287	T20EPR-U	T20TT
EON4/286	PT16VR13	TV16TT
EON4/287	PT16VR13	TV16TT
EON5/286	W20EPR-U	W20TT
EON5/287	W20EPR-U	W20TT
F10	MA20PR-U	-
F10C	MA20PR-U	-
F11Y	MA16PR-U	-
F11YC	MA16PR-U	-
F14Y	MA9P-U	-
F14YC	MA9P-U	-
F7Y	MA20P-U	-
F7YC	MA20P-U	-
F7YCC	MA20P-U	-
F9Y	MA20P-U	-
F9YC	MA20P-U	-
FN14LY	KJ16CR-L11	K16TT
FN507Y	Q22PR-U	-
G2	U24ESR-N	-
G508R	IU01-34	-
G509	IU01-34	-
G52V	RU01-34	-
G53C	IU01-34	-
G53R	IU01-34	-
G54R	IU01-31	-
G54V	RU01-31	-
G55	U31ESR-N	-
G55C	U31ESR-N	-
G55R	IU01-31	-
G56R	IU01-31	-
G57C	U31ESR-N	-
G57R	IU01-31	-
G58	U27ES-N	-
G59C	U27ES-N	-
G59C-ST/003	U27ES-N	-
G59R	IU01-27	-
G61	U27ES-N	-
G63	U24ESR-N	-
G7C	U22ESR-N	-
GI	U27ES-N	-
H10	W16LS	-
H10C	W16LS	-
H10J	W14L	-
H11	W14L	-
H12	W14L	-
H18Y	W16LS	-
H8	W16LS	-
H8C	W16LS	-
H8J	W16LS	-
H9	W16LS	-
J10	W20S-U	-
J10Y	W20PR-U	-
J11	W9-U	-
J11C	W9-U	-
J11J	W9-U	-
J11Y	W16PR-U	-
J12C	W9-U	-
J12J	W9-U	-
J12Y	W16PR-U	-
J12YC	W16PR-U	-
J13Y	W14PR-U	-
J14J	W9-U	-
J14Y	W14PR-U	-
J14YC	W14PR-U	-
J17LM	W14LM-U	-

Spark & Glow Plugs

Cross Reference Chart - Competitor

CHAMPION	DENSO	TT
J18Y	W9PR-U	-
J18YC	W9PR-U	-
J19LM	W9LM-US	-
J19V	W14LM-US	-
J2	W27S-U	-
J2J	W27S-U	-
J4	W24S-U	-
J4C	W24S-U	-
J4J	W24S-U	-
J5	W22S-U	-
J6	W20S-U	-
J6C/T04	W20S-U	-
J6J	W20S-U	-
J7	W16S-U	-
J7J	W16S-U	-
J8	W14PR-U	-
J8C	W14PR-U	-
J8J	W14PR-U	-
K13	L14-U	-
K15J	L14-U	-
K8	M22	-
K9	M22	-
KB77WPCC	GI3-1	-
KC10PYPB4	PK16PR-L11	IK16TT
KC11PYP	PK16PR-L11	IK16TT
KC8WYPB4	SK20PR-L9	IK20TT
KC8ZMCC	K20PBR-S10	K20TT
KC8ZPYPB4	PKJ16CR-L11	IK16TT
L10	W16FSR	-
L10S	W22FS-U	-
L11YC	W16FPR-U	-
L12Y	W16FPR-U	-
L14U	W14F-U	-
L20V	SF-50	-
L288	W16FSR	-
L2G	IWF27	-
L3G	IWF24	-
L4G	IWF22	-
L4J	W27FSR	-
L5	W22FS-U	-
L55C	W31FS	-
L55G	W31FS	-
L57R	IWF27	-
L58R	IWF27	-
L5YC	W24FP-U	-
L60R	IWF24	-
L61Y	W24FP-U	-
L62R	IWF24	-
L64Y	W22FPR-U	-
L66Y	W20FPR-U	WF20TT
L6G	IWF22	-
L6VC	IWF22	-
L70V	SF-50	-
L76V	SF-50	-
L77J	W27FSR	-
L77J4	W27FSR-U10	-
L77JC	W27FSR	-
L77JC4	W27FSR-U10	-
L78	W24FSR	-
L78C	W24FSR	-
L78V	SF-51	-
L78Y	W24FP-U	-
L78YC	W24FP-U	-
L78YC6	W24FPR-U10	-
L7J	W22FS-U	-
L7YC	W22FPR-U	-
L7YC4	W22FP-U	-
L81Y	W22FPR-U	-
L82C	W22FS-U	-
L82C/T10	W22FS-U	-
L82CC	W22FS-U	-

CHAMPION	DENSO	TT
L82Y	W22FPR-U	-
L82YC	W22FPR-U	-
L82YCC	W22FPR-U	-
L85	W20FSR-U	WF20TT
L85C	W20FSR-U	WF20TT
L86	W16FSR	-
L86C	W16FSR	-
L86CC	W16FSR	-
L87R	IWF27	-
L87Y	W20FPR-U	WF20TT
L87YC	W20FPR-U	WF20TT
L87YCC	W20FPR-U	WF20TT
L88A	W16FSR	-
L89CM	W16FSR	-
L90	W16FSR	-
L90C	W16FSR	-
L92Y	W16FPR-U	-
L92YC	W16FPR-U	-
L9G	IWF22	-
L9J	W20FSR-U	WF20TT
L9YC	W20FPR-U	WF20TT
N1	W31ESR-U	-
N10PY	IW20	IW20TT
N10Y	W20EX-U	W20TT
N10Y4	W20EPR-U11	W20TT
N11Y	W16EPR-U	W16TT
N11YC	W16EPR-U	W16TT
N11YC4	W16EPR-U11	W16TT
N11YCC	W16EPR-U	W16TT
N12Y	W16EPR-U	W16TT
N12YC	W16EPR-U	W16TT
N12YCC	W16EPR-U	W16TT
N13L	J16BR-U	-
N13Y	W16EPR-U	W16TT
N14LY	J16AR-U11	-
N14Y	W16EPR-U	W16TT
N16Y	W14EPR-U	IW16TT
N16YC	W14EPR-U	IW16TT
N178B	IRE01-27	-
N179BC	IRE01-27	-
N180B	IRE01-27	-
N1C	W27ESR-U	-
N2	W27ESR-U	-
N21	W14E	-
N279Y	W22EPR-U	W22TT
N279YC	W22EPR-U	W22TT
N281YC	W20EP-U	W20TT
N288	W20ESR-U	-
N2C	W27ESR-U	-
N2G	IW27	-
N3	W24ESR-U	-
N3C	W24ESR-U	-
N3CX	W24ESR-U	-
N3G	IW24	-
N4	W22ESR-U	-
N4C	W22ESR-U	-
N4G	W22ESR-U	-
N4YC	W22EPR-U	W22TT
N5	W20ESR-U	-
N54R	IW01-34	-
N55G	IW34	-
N57	W31ESR-U	-
N57G	IW31	-
N57R	IW01-31	-
N59G	IW29	-
N5C	W20ESR-U	-
N5G	IW20	IW20TT
N5YC	W24EPR-U	-
N6	W16ESR-U	-
N60	W27ESR-U	-
N60R	IW01-29	-

CHAMPION	DENSO	TT
N60Y	IW27	-
N61YD	IW27	-
N62R	IW01-27	-
N63Y	IW27	-
N63YD	W24EPR-U	-
N64Y	W24EPR-U	-
N65Y	W22EPR-U	W22TT
N66Y	W20EP-U	W20TT
N6BYC	W22EPB	W22TT
N6GY	IW24	-
N6Y	W24EPR-U	-
N6YC	W24EPR-U	-
N6YCC	W24EPR-U	-
N6YCX	W24EPR-U	-
N7	W16ESR-U	-
N74C	W22ESR-U	-
N79Y	W22EPR-U	W22TT
N7BMC	W20ETR-L	IW20TT
N7BYC	W22EPB	W22TT
N7C	W22ESR-U	-
N7GY	IW22	-
N7LCC	W22EPR-U	W22TT
N7Y	W22EPR-U	W22TT
N7YC	W22EPR-U	W22TT
N7Y4	W22EPR-U11	W22TT
N7YCC	W22EPR-U	W22TT
N7YCE	W22EPR-U	W22TT
N7YCX	W22EPR-U	W22TT
N8	W20ESR-U	-
N80	IW01-34	-
N80G	IW34	-
N82	IW29	-
N82G	IW31	-
N82S	IW31	-
N84	W27ES-V	-
N84G	IW29	-
N86	W24ES-V	-
N86G	IW27	-
N87	W24ESR-U	-
N87G	IW24	-
N88	W16ESR-U	-
N8GY	IW20	IW20TT
N8L	J16BR-U	-
N8Y	W20EP-U	W20TT
N9BMC	W20ETR-L	IW20TT
N9BYC	W20EPB	W20TT
N9BYC4	W20EPB	W20TT
N9Y	W20EP-U	W20TT
N9YC	W20EX-U	W20TT
N9Y4	W20EXR-U11	W20TT
N9YCC	W20EP-U	W20TT
N9YCX	W20EP-U	W20TT
NA12	IW29	-
NA14	IW31	-
NR2C	W27ESR-U	-
OBL9Y	T20PR-U	ITF20TT
OE001/R04	W20EP-U	W20TT
OE001/T10	W20EP-U	W20TT
OE002/R04	K20PR-U	K20TT
OE002/T10	K20PR-U	K20TT
OE003/T10	Q20PR-U	Q20TT
OE004/R04	W20EPR-U	W20TT
OE004/T10	W20EPR-U	W20TT
OE005/T10	Q20PR-U	Q20TT
OE006/R04	W20EPR-U	W20TT
OE006/T10	W20EPR-U	W20TT
OE007/R04	W20FPR-U	WF20TT
OE007/T10	W20FPR-U	WF20TT
OE008/R04	W22EPR-U	W22TT
OE008/T10	W22EPR-U	W22TT
OE009/T10	T20EPR-U	T20TT

CHAMPION	DENSO	TT
OE010/R04	W22EPR-U	W22TT
OE010/T10	W22EPR-U	W22TT
OE011/R04	T20EPR-U	T20TT
OE011/T10	T20EPR-U	T20TT
OE012/R04	W22EPB	W22TT
OE012/T10	W22EPB	W22TT
OE013/R04	Q16PR-U	Q16TT
OE013/T10	Q16PR-U	Q16TT
OE014/T10	K22PR-U	-
OE015/R04	W16EPR-U	W16TT
OE015/T10	W16EPR-U	W16TT
OE016/R04	K16PR-U	K16TT
OE016/T10	K16PR-U	K16TT
OE017/T10	Q22PR-U	-
OE018/R04	W22EPR-U	W22TT
OE018/T10	W22EPR-U	W22TT
OE019/R04	K16TNR-S9	K16TT
OE019/T10	K16TNR-S9	K16TT
OE020/T10	T20EPR-U	T20TT
OE021/T10	K22TNR-S	-
OE022/T10	W20EP-U	W20TT
OE023/T10	Q20PR-U	Q20TT
OE024/T10	Q20PR-U11	Q20TT
OE025/R04	W20EPBR-S	W20TT
OE025/T10	W20EPBR-S	W20TT
OE026/T10	K20TXR	K20TT
OE027/R04	W20EPBR-S	W20TT
OE027/T10	W20EPBR-S	W20TT
OE028/R04	W16EPB10	W16TT
OE028/T10	W16EPB10	W16TT
OE029/R04	PT16VR13	TV16TT
OE029/T10	PT16VR13	TV16TT
OE030/T10	K20TNR	K20TT
OE031/R04	PT16VR13	TV16TT
OE031/T10	PT16VR13	TV16TT
OE032/R04	K20PBR-S10	K20TT
OE032/T10	K20PBR-S10	K20TT
OE033/R04	K20PR-U	K20TT
OE033/T10	K20PR-U	K20TT
OE034/R04	K20PR-U	K20TT
OE034/T10	K20PR-U	K20TT
OE035/T10	K20HR-U11	KH20TT
OE036/T10	T20EPR-U	T20TT
OE037/T10	W16FSR	-
OE038/T10	W22FPR-U	-
OE039/R04	Q20PR-U11	Q20TT
OE039/T10	Q20PR-U11	Q20TT
OE040/T10	W27ESR-U	-
OE041/T10	KJ16CR-L11	K16TT
OE042/R04	W16EPR-U	W16TT
OE042/T10	W16EPR-U	W16TT
OE043/T10	Q22PR-U	-
OE044/T10	W20EPB	W20TT
OE045/T10	W16EPR-U	W16TT
OE046/T10	W22EPR-U	W22TT
OE047/T10	W20EPR-U11	W20TT
OE048/R04	Q22PR-U	-
OE048/T10	Q22PR-U	-
OE049/T10	W16EPR-U11	W16TT
OE050/R04	T22EP-U	-
OE050/T10	T22EP-U	-
OE051/R04	W16EPR-U	W16TT
OE051/T10	W16EPR-U	W16TT
OE052/T10	XU24EPR-U	-
OE053/T10	MA20PR-U	-
OE054/R04	MA20PR-U	-
OE054/T10	MA20PR-U	-
OE055/T10	W16EPR-U	W16TT
OE056/T10	Q22PR-U11	-
OE057/R04	Q16PR-U11	Q16TT
OE057/T10	Q16PR-U11	Q16TT

CHAMPION	DENSO	TT
OE058/R04	Q22PR-U	-
OE058/T10	Q22PR-U	-
OE059/R04	W16FPR-U	-
OE059/T10	W16FPR-U	-
OE060/T10	J16CR-U	W16TT
OE061/T10	MA20P-U	-
OE062/T10	K16PR-U11	K16TT
OE063/T10	K16PR-U11	K16TT
OE064/T10	W22FPR-U	-
OE065/T10	W16EPR-U	W16TT
OE066/R04	K20R-U	K20TT
OE066/T10	K20R-U	K20TT
OE067/T10	T22EP-U	-
OE068/T10	W24ESR-U	-
OE070/T10	W20FPR-U	WF20TT
OE071/T10	W22FPR-U	-
OE072/T10	T20EPR-U	T20TT
OE073/T10	XU24EPR-U	-
OE074/T10	W20ESR-U	-
OE075/T10	Q22PR-U	-
OE076/T10	K22PB	-
OE077/T10	K22PBR-S	-
OE078/T10	IW24	-
OE079/T10	W22ESR-U	-
OE080/T10	Q22PR-U11	-
OE081/T10	K20PR-U11	K20TT
OE082/T10	T22EP-U	-
OE083/T10	XU24EPR-U	-
OE084/R04	W24EPR-U	-
OE084/T10	W24EPR-U	-
OE085/T10	K20TXR	K20TT
OE086/T10	W22FSR	-
OE087/R04	W24EPR-U	-
OE087/T10	W24EPR-U	-
OE088/T10	Q16PR-U	Q16TT
OE089/R04	KJ20CR-L11	K20TT
OE089/T10	KJ20CR-L11	K20TT
OE090/T10	T22EP-U	-
OE091/T10	W27ESR-U	-
OE092/T10	U27ESR-N	-
OE093/R04	K16PR-U	K16TT
OE093/T10	K16PR-U	K16TT
OE094/T10	Q22PR-U	-
OE095/T10	W22ETR-L	-
OE096/T10	W16FSR	-
OE097/T10	W22EPR-U	W22TT
OE098/T10	W22ESR-U	-
OE099/T10	T16EPR-U	T16TT
OE100/T10	W20ETR-L	IW20TT
OE101/T10	W16EPR-U11	W16TT
OE102/T10	K20PR-U	K20TT
OE103/T10	IXU27	-
OE104/T10	W22FPR-U	-
OE105/T10	P16R13	W20TT
OE106/T10	W16EPR-U	W16TT
OE107/T10	W22EPR-U11	W22TT
OE108/T10	W24ESR-U	-
OE109/T10	W22EPB	W22TT
OE110/T10	Q22PR-U	-
OE111/T10	W20EPR-U	W20TT
OE112/T10	IX24	-
OE113/R04	W20EPR-U11	W20TT
OE113/T10	W20EPR-U11	W20TT
OE114/T10	QJ16AR-U11	-
OE115/T10	QJ16AR-U	-
OE116/T10	W24EPR-U	-
OE117/T10	W22EPR-U11	W22TT
OE118/T10	K22PBR-S	-
OE119/T10	K20PR-U	K20TT
OE120/R04	K20PBR-S10	K20TT
OE120/T10	K20PBR-S10	K20TT

CHAMPION	DENSO	TT
OE121/T10	Q16PR-U	Q16TT
OE122/T10	IU22	-
OE123/T10	K20PBR-S10	K20TT
OE124/T10	PK16PR11	K16TT
OE125/T10	IW27	-
OE126/T10	K20PR8	-
OE127/T10	K20PR-U	K20TT
OE128/T10	QJ16AR-U11	-
OE129/T10	IK22	-
OE130/R04	XE20HR-U9	IXEH20TT
OE130/T10	XE20HR-U9	IXEH20TT
OE131/R04	PT16EPR-L13	IT16TT
OE131/T10	PT16EPR-L13	IT16TT
OE132/T10	XU24EPR-U	-
OE133/T10	T22EP-U	-
OE134/T10	PK16R8	IK16TT
OE135/T10	K16HPR-U11	KH16TT
OE136/R04	PK20PR-P8	IK20TT
OE136/T10	PK20PR-P8	IK20TT
OE137/T10	Q16PR-U	Q16TT
OE138/T10	PK16PR-L11	IK16TT
OE140/T10	KJ20CR-L11	K20TT
OE141/T10	IK16	IK16TT
OE142/T10	IXU27	-
OE143/T10	PK20PR-P8	IK20TT
OE144/R04	PK20PR-P8	IK20TT
OE144/T10	PK20PR-P8	IK20TT
OE145/R04	IK16	IK16TT
OE145/T10	IK16	IK16TT
OE146/R04	PK20PR11	K20TT
OE146/T10	PK20PR11	K20TT
OE147/T10	KJ20CR-L11	K20TT
OE148/T10	K16HPR-U11	KH16TT
OE149/T10	PK16PR-L11	IK16TT
OE150/T10	IU24	-
OE151/T10	T16EPR-U	T16TT
OE152/T10	K20PR-U11	K20TT
OE153/T10	K16PR-U	K16TT
OE154/T10	KJ16CR-L11	K16TT
OE155/T10	MA20PR-U	-
OE156/T10	J16BR-U	-
OE157/T10	IK27	-
OE158/T10	IK31	-
OE160/T10	J16BR-U	-
OE161/T10	W16EPR-U	W16TT
OE162/T10	W20ESR-U	-
OE163/T10	ITL16	ITL16TT
OE164/T10	IK27	-
OE165/T10	IK31	-
OE166/T10	U24ES-N	-
OE167/T10	ITL16	ITL16TT
OE168/T10	PT16EPR-L13	IT16TT
OE169/T10	IT27	-
OE170/T10	W16EPR-U	W16TT
OE171/T10	T20PR-U	ITF20TT
OE172/T10	W27ES-V	-
OE173	X31ESR-U	-
OE174/T10	ITL20	-
OE175	IKH16	IKH16TT
OE175/R04	IKH16	IKH16TT
OE175/R04	K16HPR-U11	KH16TT
OE175/T10	K16HPR-U11	KH16TT
OE176/T10	PKJ16CR-L11	IK16TT
OE177/T10	KJ16CR-L11	K16TT
OE178/R04	K20HR-U11	KH20TT
OE178/T10	K20HR-U11	KH20TT
OE179	VK20Y	-
OE179/R04	VK20Y	-
OE179/T10	VK20Y	-
OE180/R04	SK16PR-A11	IK16TT
OE180/T10	SK16PR-A11	IK16TT

CHAMPION	DENSO	TT
OE181/R04	SK20PR-L9	IK20TT
OE181/T10	SK20PR-L9	IK20TT
OE182/R04	SK20R11	IK20TT
OE182/T10	SK20R11	IK20TT
OE183/R04	VT20	IT20TT
OE183/T10	VT20	IT20TT
OE185/T10	VKB20	-
OE186/T10	XU22EPR-U	XU22TT
OE189/R04	ITV16	ITV16TT
OE189/T10	ITV16	ITV16TT
OE190/R04	IKH20	IKH20TT
OE190/T10	IKH20	IKH20TT
OE191/R04	PK16PR-L11	IK16TT
OE191/T10	PK16PR-L11	IK16TT
OE198/T10	KJ20CR-L11	K20TT
OE199/T10	XU22EPR-U	XU22TT
OE201/T10	XU22HDR9	XUH22TT
OE240	IKH16	IKH16TT
OJ11Y	W16PR-U	-
OJ12Y	W16PR-U	-
OJ13Y	W16PR-U	-
ON11Y	W16EPR-U	W16TT
ON12Y	W16EPR-U	W16TT
P10Y	X20FSR-U	-
P7	X24FS-U	-
P7Y	X20FSR-U	-
P82M	W22FS-U	-
P86M	W16FSR	-
P8Y	X20FSR-U	-
PA5HC	X22ESR-U	-
PA7HC	X22ESR-U	-
PG7C	U22ESR-N	-
PL11YC	W16FPR-U	-
PL5YC	W24FP-U	-
PL7YC	IWF22	-
PL7YC4	W20FPR-U10	WF20TT
PL9YC	W20FPR-U	WF20TT
PN5C	W24ESR-U	-
PN5YC	IW24	-
PN7C	IW24	-
PRA7HC	X22EPR-U9	-
PRL5SC	W20FR-L	WF20TT
PRL9SC	W14FR-L	-
PRZ9HC	U20FSR-U	-
PZ7HC	U22FSR-U	-
PZ9HC	U20FSR-U	-
QC12PEP	SKJ20CR-A8	-
QC12PEPB	SKJ20CR-A8	-
QC12YC	Q16PR-U	Q16TT
QC501V	IK02-31	-
QC57	IK31	-
QC57C	IK31	-
QC59	IK31	-
QC59C-ST/003	IK27	-
QC59YC	IK27	-
QC61YC	IK27	-
QC9MC4	KJ20CR-L11	K20TT
QJ19LM	W9LMR-US	-
QL16V	W24FSR	-
QL55	W31FS	-
QL57	IWF27	-
QL76V	SF-50	-
QL77CC	W27FSR	-
QL77J	W27FSR	-
QL77J4	W27FSR-U10	-
QL77JC	W27FSR	-
QL77JC4	W27FSR-U10	-
QL78C	W24FSR	-
QL78V	SF-51	-
QL78YC	W24FPR	-
QL78YC6	W24FPR-U10	-

CHAMPION	DENSO	TT
QL7J	W22FSR	-
QL81Y	W22FPR-U	-
QL82C	W22FSR	-
QL82YC	W22FPR-U	-
QL86	W20FSR-U	WF20TT
QL86C	W20FSR-U	WF20TT
QL87C	W20FSR-U	WF20TT
QL87YC	W20FPR-U	WF20TT
QN1	W31ESR-U	-
QN14MC	J16CR-U	W16TT
QN2	W27ESR-U	-
QN2C	W27ESR-U	-
QN2G	IW27	-
QN3	W24ESR-U	-
QN3C	W24ESR-U	-
QN3G	IW24	-
QN508V	IW01-32	-
QN53VS	IW01-32	-
QN84	W27ESR-V	-
QN86/012	W24ESR-V	-
QN86C	W24ESR-V	-
R10	X20ESR-U	-
R6	X24ESR-U	-
R6G	IX24	-
R8	X22ESR-U	-
RA2HC	X27ESR-U	-
RA4GHC	XU27EPR-U	-
RA4HC	XU24EPR-U	-
RA4HCC	XU24EPR-U	-
RA4HCX	XU24EPR-U	-
RA4YC	XU27EPR-U	-
RA59GC	IXU27	-
RA59PP	IXU27	-
RA5YC	XU27EPR-U	-
RA6	XU24EPR-U	-
RA6HC	XU24EPR-U	-
RA6Y	XU24EPR-U	-
RA6YC	XU24EPR-U	-
RA7YC	XU22EPR-U	XU22TT
RA8GHC	IXU22	-
RA8HC	XU22EPR-U	XU22TT
RA8Y	X22EPR-U9	-
RA8YC	XU22EPR-U	XU22TT
RA8YCX4	XU22EPR-U	XU22TT
RAX92C	X27ESR-U	-
RAX92DC	X27ETR	-
RAX92YC	X27EPR-U9	-
RAX94C	X24ESR-U	-
RAX94YC	X24EPR-U9	-
RAX96C	X22ESR-U	-
RAX96YC	X22EPR-U9	-
RB75N	GI3-1	-
RB75PP	GI3-1	-
RB75WPCC	GL3-1	-
RB76N	GI3-1	-
RB76PP	GI3-1	-
RB77CC	GI3-1	-
RB77WPC	GI3-1	-
RB77WPCC	GI3-1	-
RBL11Y	T20PR-U	ITF20TT
RBL11Y4	T20PR-U11	ITF20TT
RBL11Y6	T20PR-U15	ITF20TT
RBL12	T16R-U	IT16TT
RBL126	T16R-U	IT16TT
RBL13Y	T16PR-U	ITF16TT
RBL13Y6	T16PR-U15	ITF16TT
RBL15Y	T16PR-U	ITF16TT
RBL15Y4	T16PR-U11	ITF16TT
RBL15Y6	T16PR-U15	ITF16TT
RBL15Y8	T16PR-U15	ITF16TT
RBL16Y	T14PR-U	ITF16TT

Spark & Glow Plugs

Cross Reference Chart - Competitor

CHAMPION	DENSO	TT
RBL17Y	T14PR-U	ITF16TT
RBL17Y6	T14PR-U	ITF16TT
RBL8	T20R-U	-
RBL86	T20R-U	-
RBL9Y	T20PR-U	ITF20TT
RBN12Y	T16EPR-U	T16TT
RBN13Y	T16EPR-U	T16TT
RBN14Y	T16EPR-U	T16TT
RBN7Y	IT22	-
RBN9GY	IT20	IT20TT
RBN9Y	T20EPR-U	T20TT
RC10DMC	K20TXR	K20TT
RC10ECC	KJ20CR-U11	K20TT
RC10MC4	K16R-U11	K16TT
RC10MCC	KJ20CR-L11	K20TT
RC10PMPA	PKJ16CR8	-
RC10PYC	IK16	IK16TT
RC10PYP4	PK16PR-L11	IK16TT
RC10PYPB4	PK16PR-L11	IK16TT
RC10VTC4	K20PBR-S10	K20TT
RC10WYYPB4	SK16PR-A11	IK16TT
RC10YC	K16PR-U	K16TT
RC10YC4	K16PR-U11	K16TT
RC10YCC	K20PR-U	K20TT
RC10YCC4	K16PR-U11	K16TT
RC10YCL	K16PR-U	K16TT
RC10YCX	K16PR-U	K16TT
RC10YP4	IK20	IK20TT
RC11LCC4	KJ16CR-L11	K16TT
RC11PYPB4	PK16PR-L11	IK16TT
RC11ZYC4	K16GPR-U11	-
RC12ECC	KJ16CR-L11	K16TT
RC12LC	QJ16AR-U11	-
RC12LC4	KJ16CR-L11	K16TT
RC12LY	QJ16HR-U9	-
RC12LYC	KJ16CR-L11	K16TT
RC12LYC5	QJ16AR-U11	-
RC12MC4	KJ16CR-L11	K16TT
RC12MCC	KJ16CR-U11	K16TT
RC12MCC4	KJ16CR-L11	K16TT
RC12PEC5/013	PKJ16CR-L13	IK16TT
RC12PMC5	PKJ16CR-L11	IK16TT
RC12YC	K16PR-U	K16TT
RC12YC4	K16PR-U11	K16TT
RC12YC5	K16R-U11	K16TT
RC12YCC	Q16PR-U	Q16TT
RC12YCC4	Q16PR-U11	Q16TT
RC12YCE	Q16PR-U	Q16TT
RC279YC	K22PR-U	-
RC281YC	K20PR-U	K20TT
RC57C	IK31	-
RC59C	IK27	-
RC59YC	IK27	-
RC61YC	IK27	-
RC6BMC	K22PBR-S	-
RC6PYP	PK22PR8	-
RC6PYC	IK22	-
RC6YC	K22PR-U	-
RC6YCC	K22PR-U	-
RC78PYP	GK3-1A	-
RC78PYP15	GK3-1A	-
RC7BMC	K22PBR-S	-
RC7BYC	K22PBR-S	-
RC7BYC4	K22PBR-S	-
RC7GYC	IK22	-
RC7MCC	KJ22CR-L8	-
RC7PYCB	IK22	-
RC7PYCB4	IK20	IK20TT
RC7Y	Q22PR-U	-
RC7YC	K22PR-U	-

CHAMPION	DENSO	TT
RC7YC4	K22PR-U11	-
RC7YCC	K22PR-U	-
RC7YCC4	K22PR-U11	-
RC7YCX	K22PR-U	-
RC87PYC	K20PSR-B8	IK20TT
RC87YC	K20PR-U	K20TT
RC87YCC	K20PR-U	K20TT
RC87YCL	K20PR-U	K20TT
RC89PYC	IK16	IK16TT
RC89TMC	K20PBR-S10	K20TT
RC89WYYPB4	SK20R11	IK20TT
RC89YCC	K16PR-U	K16TT
RC89YCL	K16PR-U	K16TT
RC8BYC	K20PBR	K20TT
RC8DMC	K20TXR	K20TT
RC8J	W20MR-U	-
RC8MCC	KJ20CR-L11	K20TT
RC8MCC4	KJ20CR-L11	K20TT
RC8PMPA	PKJ20CR8	-
RC8PYCB	PK20PR-P8	IK20TT
RC8PYP	PK20PR-P8	IK20TT
RC8PYP4	PK20PR11	K20TT
RC8PYPB4	PK20PR11	K20TT
RC8TYC	K20PBR-S10	K20TT
RC8VTC	K20PBR-S10	K20TT
RC8VTC4	K20PBR-S10	K20TT
RC8WYYPB4	PK20PR-L11	IK20TT
RC8YC	K20PR-U	K20TT
RC8YC4	K20PR-U11	K20TT
RC8YCC	K20PR-U	K20TT
RC8YCC4	K20PR-U11	K20TT
RC8YCL	K20PR-U	K20TT
RC8YLC	K20PR-U	K20TT
RC9BMC	K20TXR	K20TT
RC9BYC	K20PBR	K20TT
RC9MC4	KJ20CR-L11	K20TT
RC9MCC	K20R-U	K20TT
RC9MCC4	KJ20CR-L11	K20TT
RC9Y	Q20PR-U	Q20TT
RC9YC	K20PR-U	K20TT
RC9YC4	K20PR-U11	K20TT
RC9YCC	K20PR-U	K20TT
RC9YCC4	K20PR-U11	K20TT
RC9YCE	Q20PR-U	Q20TT
RC9YCN4	K20PR-U11	K20TT
RCJ4	W22M-U	-
RCJ6	W22M-U	-
RCJ6Y	W22MPR-U	-
RCJ7Y	W22MPR-U	-
RCJ8	W20MR-U	-
RCJ8Y	W20MPR-U10	-
RD14	L14-U	-
RD15Y	L14-U	-
RD16	L14-U	-
RD16J	L14-U	-
RD18Y	L14-U	-
RDJ6J	T22M-U	-
RDJ7J	T20M-U	-
RDJ7Y	T20MP-U	-
RDJ8J	T20M-U	-
RE10LC	T20NR-U11	IT20TT
RE10PM5	ITL20	-
RE10PMC5	ITL20	-
RE12PEC5	ITL16	ITL16TT
RE12PMC5	ITL16	ITL16TT
RE14MCC4	ITL16	ITL16TT
RE14MCC5	ITL16	ITL16TT
RE14PLP5	ITL16	ITL16TT
RE14PMC5	ITL16	ITL16TT
RE16MC	ITL16	ITL16TT
RE7PYC5	ITV16	ITV16TT

CHAMPION	DENSO	TT
RE7PYP6	PT16VR13	TV16TT
RE7YCC	T16VR-U10	TV16TT
REA12WMB4	IKH16	IKH16TT
REA8MCL	XE20HR-U9	XE20TT
REA8MX	XE20HR-U9	XE20TT
REC10PYC4	IKH16	IKH16TT
REC10WYYPB4	VKH20Y	-
REC10YC4	K16HPR-U11	KH16TT
REC14MCC5	ITL16	ITL16TT
REC14PYC	K16HPR-U11	KH16TT
REC9MCLX	K20HR-U11	KH20TT
REC9YCL	K20HR-U11	KH20TT
RER8MCL	XU22HDR9	XUH22TT
RER8YC	IXUH22	-
RER8ZYCB4	ITV20	ITV20TT
RES9PYP4	PT16VR13	TV16TT
RES9WYYPB5	ITV16	ITV16TT
RES9YCC4	T16VR-U10	TV16TT
RF10	MA20PR-U	-
RF10C	MA20PR-U	-
RF11LC	MA20PR-U	-
RF11Y	MA16PR-U	-
RF11YC	MA16PR-U	-
RF12	MA16PR-U	-
RF125	MA16PR-U	-
RF14LC	MA16PR-U	-
RF14Y	MA9P-U	-
RF14Y4	MA16PR-U	-
RF14YC	MA16PR-U	-
RF18YC	MA9P-U	-
RF7YC	MA20PR-U	-
RF7YCC	MA20PR-U	-
RF9Y	MA20PR-U	-
RF9YC	MA20PR-U	-
RF58LZP	IK16	IK16TT
RFN14LY/013	QJ16AR-U	-
RG2PH	IU24	-
RG4HC	U27ESR-N	-
RG4PHP	IU27	-
RG519HC	U27ESR-N	-
RG59V	RU01-31	-
RG6PP	IU24	-
RG6YC	U24ESR-N	-
RG6YCA	U24ESR-N	-
RG6YCH	N24EXRB	-
RG92C	U27ESR-N	-
RG92DC	U27ETR	-
RG94C	U24ESR-N	-
RG96C	U22ESR-N	-
RGU92C	U27FER9	-
RGU94C	U24FER9	-
RH10C	W16LS	-
RH12	W16LS	-
RH8C	W16LS	-
RJ10Y	W20PR-U	-
RJ11	W20SR-U	-
RJ11Y	W16PR-U	-
RJ12C	W14PR-U	-
RJ12Y	W16PR-U	-
RJ12Y6	W16PR-U	-
RJ12YC	W16PR-U	-
RJ12YC6	W16PR-U	-
RJ13Y	W14PR-U	-
RJ14J	W14PR-U	-
RJ14Y	W14PR-U	-
RJ14YC	W14PR-U	-
RJ17LM	W14LM-U	-
RJ18Y	W9PR-U	-
RJ18Y6	W9PR-U	-
RJ18Y8	W9PR-U	-
RJ18YC	W9PR-U	-

CHAMPION	DENSO	TT
RJ18YC6	W9PR-U	-
RJ18YC8	W9PR-U	-
RJ19LM	W9LMR-US	-
RJ6	W20SR-U	-
RJ6C	W20SR-U	-
RJ6J	W20SR-U	-
RJ7	W20SR-U	-
RJ8	W20SR-U	-
RJ8C	W20SR-U	-
RJ8J	W20SR-U	-
RL12Y	W16FPR-U	-
RL15B	GN3-1A	-
RL19	W16FSR	-
RL4J	W24FSR	-
RL5SC	W24FR-L	-
RL77J	W27FSR	-
RL77JC4	W27FSR-U10	-
RL78	W24FSR	-
RL78C	W24FSR	-
RL7J	W22FSR	-
RL82C	W22FSR	-
RL82Y	W22FPR-U	-
RL82YC	W22FPR-U	-
RL82YCC	W22FPR-U	-
RL85G	GN3-1A	-
RL86	W20FSR-U	WF20TT
RL86C	W20FSR-U	WF20TT
RL87Y	W20FPR-U	WF20TT
RL87YC	W20FPR-U	WF20TT
RL87YCC	W20FPR-U	WF20TT
RL90	W16FSR	-
RL92YC	W16FPR-U	-
RL95YC	W14FPR-U	-
RL9SC	W20FR-L	WF20TT
RM77N	GT3-1	-
RM77PP	GT3-1	-
RM10GY	IW20	IW20TT
RM10PYP4	W20	IW20TT
RM10VTC4	W20EPBR-S	W20TT
RM10Y	W20EPR-U	W20TT
RM10Y4	W20EPR-U11	W20TT
RM10YC	W20EPR-U	W20TT
RM10YC4	W20EPR-U11	W20TT
RM10YCC4	W20EPR-U11	W20TT
RM11Y	W16EPR-U	W16TT
RM11Y4	W16EPR-U11	W16TT
RM11YC	W16EXR-U	W16TT
RM11YC4	W16EPR-U11	W16TT
RM11YCC	W16EPR-U	W16TT
RM11YCC4	W16EPR-U11	W16TT
RM12GY	IW16	IW16TT
RM12MC4	W16EXR-U11	W16TT
RM12Y4	W16EPR-U11	W16TT
RM12YC	W16EPR-U	W16TT
RM12YC4	W16EXR-U11	W16TT
RM12YC6	W16EPR-U11	W16TT
RM12YCC	W16EPR-U	W16TT
RM13L	J16BR-U	-
RM13LYC	J16BR-U	-
RM13LYC5	J16BR-U	-
RM14LY	J16BR-U	-
RM14MC5	W16EXR-U13	W16TT
RM14PMP5	P16R13	W20TT
RM14Y	W14EPR-U	IW16TT
RM14Y6	W14EXR-U11	IW16TT
RM14YC	W14EXR-U	IW16TT
RM16Y	W14EPR-U	IW16TT
RM16YC	W14EPR-U	IW16TT
RM16YC5	W14EXR-U11	IW16TT
RM179BC	IRE01-27	-
RM180B	W22EBR	-

CHAMPION	DENSO	TT
RN1C	W27ESR-U	-
RN2	W27ESR-U	-
RN279YC	W22EPR-U	W22TT
RN281YC	W20EPR-U	W20TT
RN2C	W27ESR-U	-
RN2G	IW27	-
RN3	W24ESR-U	-
RN3C	W24ESR-U	-
RN3G	IW24	-
RN4	W22ESR-U	-
RN4C	W22ESR-U	-
RN4HC	W24ESR-U	-
RN4YC	W24EPR-U	-
RN5	W20ESR-U	-
RN57YC	IW29	-
RN57YCC	IW29	-
RN5C/013	W20ESR-U	-
RN6	W20ESR-U	-
RN6Y	W24EPR-U	-
RN6YC	W24EPR-U	-
RN6YCX	W24EPR-U	-
RN74C	W22ESR-U	-
RN79G	GE3-1	-
RN79G(0.015)	GE3-1	-
RN7BYC	W22EPB	W22TT
RN7GY	IW22	-
RN7LCC	W22EPR-U	W22TT
RN7Y	W22EPR-U	W22TT
RN7YC	W22EPR-U	W22TT
RN7YC4	W22EPR-U11	W22TT
RN7YCC	W22EPR-U	W22TT
RN7YCC4	W22EPR-U11	W22TT
RN7YCX	W22EPR-U	W22TT
RN8	W20ESR-U	-
RN83C	W20ESR-U	-
RN8L	J16BR-U	-
RN8VTYC	W20EPBR-S	W20TT
RN8VTYC4	W20EPBR-S	W20TT
RN8YC	W20EPR-U	W20TT
RN8YC4	W20EPR-U11	W20TT
RN9GY	IW20	IW20TT
RN9LCC	J16CR-U	W16TT
RN9Y	W20EPR-U	W20TT
RN9YC	W20EPR-U	W20TT
RN9YC4	W20EPR-U11	W20TT
RN9YCC	W20EPR-U	W20TT
RN9YCC4	W20EPR-U11	W20TT
RN9YCE	W20EPR-U	W20TT
RN9YCX	W20EPR-U	W20TT
RP7	X24FS-U	-
RS10LC	T20EPR-U	T20TT
RS12PYP	PT16EPR-L13	IT16TT
RS12YC	T16EPR-U	T16TT
RS12YC6	T16EPR-U15	T16TT
RS13LYC	T16NR-U11	IT16TT
RS14LC/012	T16NR-U11	IT16TT
RS14YC/013	T16EPR-U	T16TT
RS14YC6/T04	T16EPR-U15	T16TT
RS15LYC/013	T16NR-U11	IT16TT
RS16YC	T16EPR-U	T16TT
RS17YX	T16EPR-U	T16TT
RS279YC	T22EP-U	-
RS281YC	T20EPR-U	T20TT
RS5C	T22EP-U	-
RS6YC	T22EP-U	-
RS6YCC	T22EP-U	-
RS7YC	T22EP-U	-
RS8WYPB5	VT20	IT20TT
RS9YP4	ZT20EPR11	T20TT
RS9Y	T20EPR-U	T20TT
RS9YC	T20EPR-U	T20TT

CHAMPION	DENSO	TT
RS9YCC	T20EPR-U	T20TT
RS9YCX	T20EPR-U	T20TT
RV12C	T16R-U	IT16TT
RV12C6	T16R-U	IT16TT
RV12YC	T20PR-U	ITF20TT
RV12YC6	T20PR-U11	ITF20TT
RV15YC	T16PR-U	ITF16TT
RV15YC4	T16PR-U11	ITF16TT
RV15YC6	T16PR-U15	ITF16TT
RV15YC8	T16PR-U15	ITF16TT
RV17YC/T04	T14PR-U	ITF16TT
RV17YC6/T04	T14PR-U	ITF16TT
RV19YC/T04	T14PR-U	ITF16TT
RV19YC6	T14PR-U	ITF16TT
RV8C	T20R-U	-
RV8C6	T20R-U	-
RV91MC	T16PR-U	ITF16TT
RV9YC/012	T20PR-U	ITF20TT
RZ8	U22FSR-U	-
RZ94C	U24FSR-U	-
RZ96C	U22FSR-U	-
RZ98C	U20FSR-U	-
S10YCC	T20EPR-U	T20TT
S12YC	T16EPR-U	T16TT
S12YCC	T16EPR-U	T16TT
S14YC	T16EPR-U	T16TT
S279YC	T20EPR-U	T20TT
S281YC	T20EPR-U	T20TT
S379YC	T22EP-U	-
S57YC	IT27	-
S59C	IT27	-
S59YC	IT27	-
S6YC	T22EP-U	-
S6YCC	T22EP-U	-
S7YC	T22EP-U	-
S7YCC	T22EP-U	-
S9YC	T20EPR-U	T20TT
S9YCC	T20EPR-U	T20TT
S9YCX	T20EPR-U	T20TT
TJ8J	W20M-US	-
UD16	L14-U	-
UJ11G	W16S-U	-
UJ12	W9-U	-
UJ12C	W14PR-U	-
UJ12Y	W16PR-U	-
UJ2J	W24S-U	-
UJ4J	W24S-U	-
UJ6	W20S-U	-
UJ8	W20S-U	-
UJ81C	W22S-U	-
UJ81J	W22S-U	-
UK10	M17	-
UL17V	SF-50	-
UL18V	SF-50	-
UL19V	SF-50	-
UL4J	W22FS-U	-
UL77V	SF-50	-
UL81C	W24FSR	-
UL81J	W24FSR	-
UN79Y	W22EPR-U	W22TT
V12YC	T16PR-U	ITF16TT
V15YC	T16PR-U	ITF16TT
V45LSR	IW22	-
V4C	ITF24	-
V4LSR	W20EPR-U	W20TT
V59C	ITF27	-
V59YC	ITF27	-
V61	ITF24	-
V63C	ITF24	-
V63Y	ITF24	-
V9YC	T20PR-U	ITF20TT

CHAMPION	DENSO	TT
XC12PEP	PKJ16CR-L11	IK16TT
XC12PEPB	PKJ16CR-L11	IK16TT
XC12YC	K16PR-U	K16TT
XC92YC	K16PR-U	K16TT
XJ10Y	W20PR-U	-
XJ4J	W24S-U	-
Y82/014	U20M-U	-
Z10G	IUF22	-
Z7G	IUF22	-
Z7HC	U22FSR-U	-
Z9HC	U20FSR-U	-
Z9Y	U22FSR-U	-
Z9YC	W14-US	-

DAYTONA MAXFIRE	DENSO	TT
61479	IW24	-
61480	IW27	-
61481	IU24	-
61482	IU27	-
61483	IUH24	-
61484	IUH27	-
61485	IUF22	-
61486	IUF22	-
61487	IUF24	-
61488	IX24	-
61489	IX27	-
61490	IWF20	-
61491	IWF22	-
61492	IWF24	-
61493	IX22B	-
61494	IX24B	-

DELPHI	DENSO	TT
HDS 241	DG-114	-
HDS 400	DG-108	-
HDS216	DG-001	-
HDS217	DG-012	-
HDS218	DG-001	-
HDS221	DG-001	-
HDS222	DG-004	-
HDS225	DG-001	-
HDS231	DG-012	-
HDS237	DG-233	-
HDS239	DG-157	-
HDS245	DG-234	-
HDS247	DG-143	-
HDS248	DG-157	-
HDS254	DG-012	-
HDS255	DG-001	-
HDS257	DG-001	-
HDS267	DG-202	-
HDS268	DG-232	-
HDS270	DG-198	-
HDS271	DG-123	-
HDS272	DG-114	-
HDS273	DG-004	-
HDS274	DG-001	-
HDS276	DG-198	-
HDS280	DG-157	-
HDS283	DG-157	-
HDS295	DG-001	-
HDS296	DG-001	-
HDS303	DG-115	-
HDS337	DG-001	-
HDS338	DG-159	-
HDS339	DG-004	-
HDS340	DG-157	-
HDS341	DG-012	-
HDS342	DG-005	-
HDS343	DG-012	-
HDS345	DG-124	-

DELPHI	DENSO	TT
HDS346	DG-104	-
HDS347	DG-006	-
HDS348	DG-001	-
HDS349	DG-001	-
HDS350	DG-003	-
HDS351	DG-001	-
HDS352	DG-010	-
HDS353	DG-001	-
HDS354	DG-106	-
HDS355	DG-101	-
HDS356	DG-102	-
HDS357	DG-132	-
HDS358	DG-137	-
HDS359	DG-137	-
HDS360	DG-118	-
HDS361	DG-109	-
HDS362	DG-007	-
HDS363	DG-119	-
HDS364	DG-127	-
HDS365	DG-161	-
HDS366	DG-009	-
HDS368	DG-005	-
HDS371	DG-001	-
HDS374	DG-144	-
HDS375	DG-111	-
HDS376	DG-008	-
HDS377	DG-117	-
HDS378	DG-155	-
HDS379	DG-121	-
HDS380	DG-129	-
HDS383	DG-130	-
HDS384	DG-142	-
HDS385	DG-112	-
HDS386	DG-133	-
HDS387	DG-184	-
HDS390	DG-186	-
HDS391	DG-174	-
HDS392	DG-187	-
HDS393	DG-245	-
HDS394	DG-146	-
HDS397	DG-173	-
HDS406	DG-181	-
HDS407	DG-182	-
HDS408	DG-176	-
HDS410	DG-240	-
HDS411	DG-306	-
HDS412	DG-307	-
HDS413	DG-177	-
HDS414	DG-190	-
HDS415	DG-178	-
HDS416	DG-180	-
HDS418	DG-196	-
HDS421	DG-188	-
HDS440	DG-183	-

DENSO	DENSO	TT
067100-1042	DG-224	-
067100-1053	DG-225	-
067100-1070	DG-236	-
067100-1071	DG-236	-
067100-1120	DG-226	-
067100-1130	DG-227	-
067100-1140	DG-228	-
067100-1220	DG-238	-
067100-1250	DG-231	-
067100-1330	DG-232	-
067100-1340	DG-233	-
067100-1350	DG-234	-
067100-1360	DG-235	-
067100-1370	DG-215	-
067100-1380	DG-239	-

DENSO	DENSO	TT
067100-1430	DG-223	-
067100-1460	DG-222	-
067100-1500	DG-213	-
067100-1621	DG-241	-
067100-1630	DG-221	-
067100-1680	DG-220	-
067100-1690	DG-216	-
067100-1700	DG-219	-
067100-1710	DG-211	-
067100-1840	DG-212	-
067100-1850	DG-501	-
067100-1860	DG-214	-
067100-1862	DG-214	-
067100-1900	DG-502	-
067100-1901	DG-502	-
067100-1910	DG-218	-
067100-1920	DG-217	-
067100-1950	DG-212	-
067100-1960	DG-242	-
067100-1980	DG-217	-
067600-0310	M14	-
067600-0320	M17	-
067600-0330	M22	-
067600-0340	M24S	-
067600-0350	K16P-U11	K16TT
067600-0390	K20P-U	K20TT
067600-0420	MW17	-
067600-0871	W9EP	-
067600-0881	W14E	-
067600-1810	IW06-27	-
067600-1820	IW06-31	-
067600-1830	IW06-34	-
067600-2210	W16EX-U	W16TT
067600-2571	W31FS	-
067600-2740	W20EPB	W20TT
067600-2750	W22EPB	W22TT
067600-2770	K22PB	-
067600-3341	W14L	-
067600-3351	W16LS	-
067600-4641	W9EX-U	-
067600-4663	W14EX-U	IW16TT
067600-4681	W20EX-U	W20TT
067600-5781	W27S-U	-
067600-6000	U20M-U	-
067600-6031	W16ES-U	-
067600-6041	W20ES-U	-
067600-6051	W22ES-U	-
067600-6061	W24ES-U	-
067600-6071	W27ES-U	-
067600-6081	W31ES-U	-
067600-6121	W14FP-U	-
067600-6131	W16FP-U	-
067600-6141	W20FP-U	WF20TT
067600-6151	W22FP-U	-
067600-6191	W27FS-U10	-
067600-6201	W20FP-U10	WF20TT
067600-6281	W24FP-U	-
067600-6441	W20EP11	W20TT
067600-6591	W14FP-UL	-
067600-6601	W9FP-UL	-
067600-6611	W14FP-UL10	-
067600-6671	W24FS-U10	-
067600-6681	W14F-U	-
067600-6701	W20EP-S11	IW20TT
067600-6711	W14LM-U	-
067600-6791	W16S-U	-
067600-6801	W20S-U	-
067600-6831	W16FS-U	-
067600-6841	W20FS-U	WF20TT
067600-6851	W22FS-U	-
067600-6861	W24FS-U	-

DENSO	DENSO	TT
067600-6871	W27FS-U	-
067600-6881	W24S-U	-
067600-6891	W22S-U	-
067600-6900	W9-U	-
067600-7071	Q16-U11	Q16TT
067600-7081	Q20-U11	Q20TT
067600-7131	W24ES-V	-
067600-7141	W27ES-V	-
067600-7200	Q16P-U11	Q16TT
067600-7221	W14EP-U	IW16TT
067600-7231	W16EP-U	W16TT
067600-7241	W20EP-U	W20TT
067600-7251	W22EP-U	W22TT
067600-7261	W24EP-U	-
067600-7380	T20EP-U	T20TT
067600-7390	T22EP-U	-
067600-7421	W14M-U	-
067600-7451	W22M-U	-
067600-7461	W14MP-U10	-
067600-7481	W20MP-U	-
067600-7491	W22MP-U	-
067600-7511	MA9P-U	-
067600-7550	MA20P-U	-
067600-7570	L14-U	-
067600-7621	W16EP-U11	W16TT
067600-7660	W20EP-U11	W20TT
067600-7670	W22EP-U11	W22TT
067600-7680	Q20P-U	Q20TT
067600-7690	Q22P-U	-
067600-7810	Q20P-U11	Q20TT
067600-7850	W16EPB10	W16TT
067600-7931	J16A-U11	-
067600-7971	J16B-U11	-
067600-8450	T20M-U	-
067600-8460	T22M-U	-
067600-8470	T20MP-U	-
067600-8480	T22MP-U	-
067600-8570	W14-US	-
067600-8590	W20M-US	-
067600-8600	W14LM-US	-
067600-8790	W9LM-US	-
067600-8900	W22FP-U10	-
067600-8960	W20FP-L	WF20TT
067600-9270	TR22-10	-
067600-9700	T16P-U	ITF16TT
067600-9711	T20P-U	ITF20TT
067700-0020	PK20PR-P8	IK20TT
067700-0300	PK20PR11	K20TT
067700-0510	K22TMR11	-
067700-0540	K16GPR-U11	-
067700-0570	KJ20CR-U11	K20TT
067700-0750	W22EBR	-
067700-0770	W27EBR	-
067700-0780	W29EBR	-
067700-0831	W16FSR	-
067700-0851	W22FSR	-
067700-0861	W24FSR	-
067700-0871	W27FSR	-
067700-0891	W27FSR-U10	-
067700-1511	W9EXR-U	-
067700-1522	W14EXR-U	IW16TT
067700-1531	W16EXR-U	W16TT
067700-1541	W20EXR-U	W20TT
067700-1871	W14FPR-UL10	-
067700-1881	W14FPR-UL	-
067700-1921	W24ESR-V	-
067700-1931	W27ESR-V	-
067700-2110	W16EKR-S11	W16TT
067700-2150	W22ETR-L	-
067700-2160	W20ETR-L	IW20TT
067700-2171	W16ETR-S	W16TT

DENSO	DENSO	TT
067700-2200	W20EKR-S11	IW20TT
067700-2330	W16ESR-U	-
067700-2341	W20ESR-U	-
067700-2351	W22ESR-U	-
067700-2361	W24ESR-U	-
067700-2371	W27ESR-U	-
067700-2421	W14EXR-U11	IW16TT
067700-2431	W16EXR-U11	W16TT
067700-2441	W20EXR-U11	W20TT
067700-2591	W20EPR-S11	W20TT
067700-2651	W14EPR-U	IW16TT
067700-2671	W20EPR-U	W20TT
067700-2681	W22EPR-U	W22TT
067700-2691	W24EPR-U	-
067700-2701	W20EPR-U11	W20TT
067700-2710	W16EPR-U11	W16TT
067700-2720	W22EPR-U11	W22TT
067700-2912	W9PR-U	-
067700-2921	W16PR-U	-
067700-2931	W14PR-U	-
067700-2951	W20PR-U	-
067700-3020	K16HPR-U11	KH16TT
067700-3041	W20SR-U	-
067700-3081	W20FPR-U10	WF20TT
067700-3130	T16EPR-U	T16TT
067700-3140	T20EPR-U	T20TT
067700-3150	SK20R-P11	IK20TT
067700-3190	T16EPR-U15	T16TT
067700-3201	W14MR-U	-
067700-3210	T20EPR-U15	T20TT
067700-3221	W20MR-U	-
067700-3281	W14MPR-U10	-
067700-3301	W20MPR-U10	-
067700-3330	W14FR-U	-
067700-3341	W20FSR-U	WF20TT
067700-3350	W22MPR-U	-
067700-3380	P20PR-S11	IW20TT
067700-3390	P16PR11	W16TT
067700-3400	P20PR11	W20TT
067700-3472	J16BR-U	-
067700-3520	SK20R5-G	-
067700-3531	J16AR-U11	-
067700-3560	SK20BR11	-
067700-3571	J16BR-U11	-
067700-3630	MA16PR-U	-
067700-3660	MA20PR-U	-
067700-3831	W20FPR-U	WF20TT
067700-3841	W22FPR-U	-
067700-4000	W24FPR	-
067700-4102	PQ20R-P8	IQ20TT
067700-4110	P16R13	W20TT
067700-4120	P16R	W20TT
067700-4171	PQ16R	Q16TT
067700-4191	PQ20R	Q20TT
067700-4220	PQ20R13	Q20TT
067700-4410	Q16R-U	Q16TT
067700-4421	Q20R-U	Q20TT
067700-4431	Q16R-U11	Q16TT
067700-4441	Q20R-U11	Q20TT
067700-4450	Q16PR-U	Q16TT
067700-4460	Q20PR-U	Q20TT
067700-4470	Q22PR-U	-
067700-4510	Q16PR-U11	Q16TT
067700-4520	Q20PR-U11	Q20TT
067700-4530	Q22PR-U11	-
067700-4670	Q14R-U11	IQ16TT
067700-4700	W16FPR-U	-
067700-4760	W14FPR-U	-
067700-4830	S-31A	-
067700-4851	PQ16R8	Q16TT
067700-4861	PQ20R8	Q20TT

DENSO	DENSO	TT
067700-5010	X16FSR-U	-
067700-5020	X20FSR-U	-
067700-5030	X27ETR	-
067700-5060	X20ESR-U	-
067700-5070	X22ESR-U	-
067700-5080	X24ESR-U	-
067700-5090	X27ESR-U	-
067700-5110	X31ESR-U	-
067700-5140	X31ETR	-
067700-5180	W24ESR	-
067700-5190	W27ESR	-
067700-5270	X16EPR-U9	-
067700-5280	X20EPR-U9	-
067700-5290	X22EPR-U9	-
067700-5300	X24EPR-U9	-
067700-5310	X27EPR-U9	-
067700-5320	U22ESR-N	-
067700-5380	U24ESR-N	-
067700-5390	U27ESR-N	-
067700-5450	U24ETR	-
067700-5460	U27ETR	-
067700-5500	W27EMR-C	-
067700-5540	X24GPR-U	-
067700-5550	X27GPR-U	-
067700-5560	U22ETR	-
067700-5580	U16FSR-U	-
067700-5590	U20FSR-U	-
067700-5600	U22FSR-U	-
067700-5610	U24FSR-U	-
067700-5630	U31ETR	-
067700-5640	U31ESR-N	-
067700-5650	T16R-U	IT16TT
067700-5700	T14PR-U	ITF16TT
067700-5750	T16PR-U	ITF16TT
067700-5760	T16PR-U11	ITF16TT
067700-5770	T16PR-U15	ITF16TT
067700-5800	XU20EPR-U	-
067700-5810	U22FER9	-
067700-5820	U24FER9	-
067700-5830	U27FER9	-
067700-5851	T20PR-U	ITF20TT
067700-5861	T20PR-U11	ITF20TT
067700-5871	T20PR-U15	ITF20TT
067700-5910	QJ16HR-U9	-
067700-5920	QJ16AR-U	-
067700-5930	QJ16AR-U11	-
067700-5950	T20R-U	-
067700-5990	U16FSR-UB	-
067700-6100	QJ20CR11	Q20TT
067700-6130	T16NR-U11	IT16TT
067700-6140	T20NR-U11	IT20TT
067700-6150	W20EPR11	IW20TT
067700-6230	QJ16CR11	Q16TT
067700-6270	K16PR-U11	K16TT
067700-6280	K20PR-U11	K20TT
067700-6290	K22PR-U11	-
067700-6300	K16PR-U	K16TT
067700-6310	K20PR-U	K20TT
067700-6400	K16R-U	K16TT
067700-6410	K20R-U	K20TT
067700-6420	K16R-U11	K16TT
067700-6430	K20R-U11	K20TT
067700-6440	PK20R-P8	IK20TT
067700-6450	W16EXR-U13	W16TT
067700-6460	PK20PR-P11	K20TT
067700-6500	W31ESR-U	-
067700-6550	K16PR-L11	K16TT
067700-6560	K20PR-L11	K20TT
067700-6570	K22PR-L11	-
067700-6661	PK16R8	IK16TT
067700-6670	PK20R8	IK20TT

DENSO	DENSO	TT
067700-6680	PK16R11	K16TT
067700-6710	PK20R13	K20TT
067700-6730	KJ14CR11	-
067700-6740	PK16PR-L11	IK16TT
067700-6750	PK20PR-L11	IK20TT
067700-6770	KJ16CR11	K16TT
067700-6780	KJ20CR11	K20TT
067700-6800	W14FR-L	-
067700-6810	W20FR-L	WF20TT
067700-6820	W24FR-L	-
067700-6870	PK16PR-P11	K16TT
067700-6940	KJ16CR-L11	K16TT
067700-6950	KJ20CR-L11	K20TT
067700-6960	KJ22CR-L11	-
067700-6990	J16CR-U	W16TT
067700-7060	K16PR-TP11	K16TT
067700-7070	K20PR-TP11	K20TT
067700-7130	PKJ16CR-L11	IK16TT
067700-7140	PKJ20CR-L11	IK20TT
067700-7190	W24EMR-C	-
067700-7240	W9EXR-U+CU	-
067700-7250	P22PR8	-
067700-7370	PK16PR11	K16TT
067700-7390	PK22PR11	-
067700-7450	KJ14CR-L11	-
067700-7480	PK20PR-L13	IK20TT
067700-7520	K22PR-U	-
067700-7550	Y24FER-C	-
067700-7560	Y27FER-C	-
067700-7570	Y31FER-C	-
067700-7690	PK22PR8	-
067700-7800	PKJ16CR8	-
067700-7810	PKJ20CR8	-
067700-7850	W9LMR-US	-
067700-7880	W22ETR-L8	-
067700-7900	K16TR11	K16TT
067700-7910	K22TNR-S	-
067700-7930	PK20TR11	K20TT
067700-7940	PT16VR13	TV16TT
067700-7990	PK16TR11	K16TT
067700-8000	K20TNR-S	K20TT
067700-8040	W20EPBR-S	W20TT
067700-8050	K20PBR	K20TT
067700-8060	K20PBR-S10	K20TT
067700-8070	K22PBR-S	-
067700-8080	K20TXR	K20TT
067700-8090	XU27EPR-U	-
067700-8110	K20TR11	K20TT
067700-8120	PK16TR13	IK16TT
067700-8140	PT16EPR-L13	IT16TT
067700-8150	XU24EPR-U	-
067700-8170	W24FSR-U10	-
067700-8211	PK20GR8	-
067700-8240	KJ22CR-L8	-
067700-8250	K16PR-P11	K16TT
067700-8270	P20PR8	IW20TT
067700-8290	U14FSR-UB	-
067700-8300	PKJ16CR-L13	IK16TT
067700-8340	SK20R11	IK20TT
067700-8350	SK16R-P8	IK16TT
067700-8360	SK20R-P13	IK20TT
067700-8430	IK22	-
067700-8460	IK24	-
067700-8470	IK27	-
067700-8480	IQ22	-
067700-8490	IQ24	-
067700-8501	IQ27	-
067700-8600	IXU27	-
067700-8620	SVK20RZ11	IK20TT
067700-8630	SK20PR-L9	IK20TT
067700-8650	IW16	IW16TT

DENSO	DENSO	TT
067700-8660	IW20	IW20TT
067700-8670	IW22	-
067700-8680	IK16	IK16TT
067700-8690	IK20	IK20TT
067700-8700	IQ16	IQ16TT
067700-8710	IQ20	IQ20TT
067700-8720	IXU22	-
067700-8730	IXU24	-
067700-8740	K24PR-U11	-
067700-8770	K20TNR	K20TT
067700-8800	K20TNR-S9	K20TT
067700-8810	KJ16CR-U11	K16TT
067700-8820	W24FPR-U10	-
067700-8840	SK16R11	IK16TT
067700-8850	U20ESR-N	-
067700-8860	SK16R-P11	IK16TT
067700-8870	XU22EPR-U	XU22TT
067700-8880	PK20R11	K20TT
067700-8890	IW24	-
067700-8900	IW27	-
067700-8910	IW29	-
067700-8920	IW31	-
067700-8930	IW34	-
067700-9220	IK31	-
067700-9230	IQ31	-
067700-9240	VW20T	IW20TT
067700-9261	IU22	-
067700-9271	IU24	-
067700-9281	IU27	-
067700-9291	IU31	-
067700-9301	IU24A	-
067700-9311	IU27A	-
067700-9320	IU31A	-
067700-9330	IUH24	-
067700-9340	IUH27	-
067700-9350	IX22	-
067700-9360	IX24	-
067700-9370	IX27	-
067700-9380	IX22B	-
067700-9390	IX24B	-
067700-9400	IX27B	-
067700-9410	IWF22	-
067700-9420	IWF24	-
067700-9430	IWF27	-
067700-9460	PKJ20CR-M11	IK20TT
067700-9480	IUF22	-
067700-9490	IUF24	-
067700-9520	IK27C11	-
067700-9540	VK20T	IK20TT
067700-9550	IK24C11	-
067700-9560	IUH24D	-
067700-9570	IUH27D	-
067700-9590	IK34	-
067700-9600	IQ34	-
067700-9670	S22PR-A7	-
067700-9680	SKJ16CR-L11	IK16TT
067700-9700	IUF27A	-
067700-9710	IUF31A	-
067700-9720	VX22BC	-
067700-9730	SK20BGR11	-
067700-9740	SVK20RZ8	IK20TT
067700-9750	K20BR-S10	K20TT
067700-9760	K20PTR-S	K20TT
067700-9770	K16TNR-S9	K16TT
067800-0031	SF-50	-
067800-0041	SF-51	-
067800-0280	SF-24	-
067800-4020	X20FS-U	-
067800-4040	X24FS-U	-
067800-4110	X20ES-U	-
067800-4120	X22ES-U	-

DENSO	DENSO	TT
067800-4130	X24ES-U	-
067800-4140	X27ES-U	-
067800-4160	X31ES-U	-
067800-4350	X22EP-U9	-
067800-4360	X24EP-U9	-
067800-4370	X27EP-U9	-
067800-4590	U16FS-U	-
067800-4600	U20FS-U	-
067800-4610	U22FS-U	-
067800-4620	U24FS-U	-
067800-4690	U16FS-UB	-
067800-4820	U24FE9	-
067800-4850	U22ES-N	-
067800-4860	U24ES-N	-
067800-4870	U27ES-N	-
067800-5050	GA3-1	-
067800-6740	GK3-1	-
067800-7040	GE5-1	-
067800-7280	PTJ16R15	IT16TT
067800-7340	ZT20EPR11	T20TT
067800-8290	XU22PR9	XU22TT
067800-8400	GI3-1	-
067800-8410	GI3-3	-
067800-8420	GL3-1	-
067800-8430	GL3-3	-
067800-8450	GL3-5	-
067800-8480	GT3-1	-
067800-9230	GE3-1	-
067800-9250	GE3-F	-
142000-0031	DG-308	-
142000-0060	DG-310	-
142000-0200	DG-305	-
142000-0210	DG-309	-
142000-0300	DG-310	-
267700-0520	U16FER9	-
267700-0540	IUF14-UB	-
267700-0550	KJ20DR-M11	IK20TT
267700-0560	SKJ20DR-M13	IK20TT
267700-0570	SK20PR-A11	IK20TT
267700-0610	IT16	IT16TT
267700-0620	IT20	IT20TT
267700-0630	IT22	-
267700-0640	IT24	-
267700-0650	IT27	-
267700-0660	ITF16	ITF16TT
267700-0670	ITF20	ITF20TT
267700-0680	ITF22	-
267700-0690	ITF24	-
267700-0700	ITF27	-
267700-0710	VK16	IK16TT
267700-0720	VK20	IK20TT
267700-0730	VK22	-
267700-0740	VQ16	IQ16TT
267700-0750	VQ20	IQ20TT
267700-0760	VQ22	-
267700-0770	VW16	IW16TT
267700-0780	VW20	IW20TT
267700-0790	VW22	-
267700-0800	VXU22	-
267700-0810	VXU24	-
267700-0840	IU24D	-
267700-0850	IU27D	-
267700-0870	SK16PR-A11	IK16TT
267700-0890	SKJ16CR-A8	-
267700-0910	SKJ20DR-M11	IK20TT
267700-0930	SK22PR-M11	-
267700-0950	KJ20SR11	IK20TT
267700-0980	PK22PR-L11S	-
267700-1010	IU01-24	-
267700-1020	IU01-27	-
267700-1030	IU01-31	-

DENSO	DENSO	TT
267700-1040	IU01-34	-
267700-1060	IXU01-24	-
267700-1070	IXU01-27	-
267700-1080	IXU01-31	-
267700-1090	IXU01-34	-
267700-1110	IW01-24	-
267700-1120	IW01-27	-
267700-1130	IW01-29	-
267700-1140	IW01-31	-
267700-1150	IW01-32	-
267700-1160	IW01-34	-
267700-1210	IWM01-29	-
267700-1220	IWM01-31	-
267700-1230	IWM01-32	-
267700-1240	IWM01-34	-
267700-1260	IA01-31	-
267700-1270	IA01-32	-
267700-1280	IA01-34	-
267700-1310	IK01-24	-
267700-1320	IK01-27	-
267700-1330	IK01-31	-
267700-1340	IK01-34	-
267700-1360	IK02-24	-
267700-1370	IK02-27	-
267700-1380	IK02-31	-
267700-1410	IQ01-24	-
267700-1420	IQ01-27	-
267700-1430	IQ01-31	-
267700-1440	IQ01-34	-
267700-1460	IQ02-24	-
267700-1470	IQ02-27	-
267700-1480	IQ02-31	-
267700-1520	IRE01-27	-
267700-1530	IRE01-31	-
267700-1540	IRE01-32	-
267700-1550	IRE01-34	-
267700-1570	RU01-27	-
267700-1580	RU01-31	-
267700-1590	RU01-34	-
267700-1760	SKJ20CR-A8	-
267700-1840	VK16PRZ11	IK16TT
267700-1850	VK20PRZ11	IK20TT
267700-1860	VK22PRZ11	-
267700-1870	VK24PRZ11	-
267700-1931	VUH27D	-
267700-1970	VKJ20RZ-M11	-
267700-2011	VUH24D	-
267700-2050	VK27PRZ11	-
267700-2060	VNH24Z	-
267700-2070	VNH27Z	-
267700-2200	SK16PR-L11	IK16TT
267700-2280	U27ESR-NB	-
267700-2290	N24EXRB	-
267700-2300	U24ESR-NB	-
267700-2320	PK20PTR-S9	K20TT
267700-2340	SK20PR-A8	IK20TT
267700-2500	ITV22	-
267700-2510	ITV24	-
267700-2520	ITV27	-
267700-2570	SK20R8	IK20TT
267700-2610	SKJ16DR-M11	IK16TT
267700-2650	IKH22	-
267700-2680	VKH22	-
267700-2730	U22ESR-NB	-
267700-2740	SK16PR-E11	IK16TT
267700-2810	VT16	IT16TT
267700-2880	K20HR-U11	KH20TT
267700-2890	IWM24	-
267700-2900	IWM27	-
267700-2910	IWM31	-
267700-2920	IXG24	-

Spark & Glow Plugs

Cross Reference Chart - Competitor

DENSO	DENSO	TT
267700-2930	IXG27	-
267700-2940	IAE01-32	-
267700-2950	IAE01-34	-
267700-2970	ZXU22HBR11	-
267700-3000	SK16HR11	IKH16TT
267700-3020	SXU22PR-A9	-
267700-3660	IKH16	IKH16TT
267700-3670	IKH20	IKH20TT
267700-3680	VKH16	IKH16TT
267700-3690	VKH20	IKH20TT
267700-3700	ITV16	ITV16TT
267700-3710	ITV20	ITV20TT
267700-3720	VK20Y	-
267700-4120	SK20HR11	IKH20TT
267700-4200	FK20HBR11	IKB20TT
267700-4230	FK20HR11	IKH20TT
267700-4280	IKH24	-
267700-4290	IKH27	-
267700-4320	ZXE20HR13	IXEH20TT
267700-4380	K20PSR-B8	IK20TT
267700-4450	IKH01-24	-
267700-4460	IKH01-27	-
267700-4470	IKH01-31	-
267700-4480	VT20	IT20TT
267700-4490	IY24	-
267700-4500	IY27	-
267700-4510	IY31	-
267700-4520	XU22HDR9	XUH22TT
267700-4530	SXU22HDR8	-
267700-4540	VKH20Y	-
267700-4570	W16EPR-U	W16TT
267700-4580	U20EPR9	-
267700-4770	VUH27ES	-
267700-4810	T16VR-U10	TV16TT
267700-4820	IRL01-27	-
267700-4830	IRL01-31	-
267700-4840	IRT01-31	-
267700-4850	IRT01-34	-
267700-4880	FXE20HR11	IXEH20TT
267700-4900	GX8-1	-
267700-4930	SKJ20DR-M11S	-
267700-4950	FXE16HE11	-
267700-4980	ITL16	ITL16TT
267700-4990	ITL20	-
267700-5000	IWF16	-
267700-5010	IWF20	-
267700-5020	IU20	-
267700-5030	VKA16	-
267700-5040	VKA20	-
267700-5050	VKB16	-
267700-5060	VKB20	-
267700-5120	IK16L	IK16TT
267700-5130	IK20L	IK20TT
267700-5290	FK16R11	IK16TT
267700-5480	FXE20HE11	IXEH20ETT
267700-5490	XU22PR9	XU22TT
267700-5500	SK20HPR-L11	IKH20TT
267700-5530	SXU22HCR11S	-
267700-5580	SC20HR11	IXEH22TT
267700-5590	GX8-1	-
267700-5600	SK20PR-L11	IK20TT
267700-5610	IK16G	-
267700-5620	IK20G	-
267700-5630	VK16G	IK16TT
267700-5640	VK20G	-
267700-5660	IK22G	-
267700-5670	VK22G	-
267700-5810	XE20HR-U9	IXEH20TT
267700-5830	FXE22HR11	IXEH22TT
267700-5860	K16PSR-B8	IK16TT
267700-5900	SXU22PR9	-

DENSO	DENSO	TT
267700-6120	PT16VR10	TV16TT
267700-6130	VUH24ES	-
267700-6160	SK22PR-M11S	-
267700-6280	K16HR-U11	KH16TT
267700-6301	W16TT	W16TT
267700-6310	W20TT	W20TT
267700-6450	IXUH22	-
267700-6460	VXUH22	-
267700-6480	U22EPR9	-
267700-6490	U24EPR9	-
267700-6970	FXE24HR11	-
267700-7020	ZXU20PR11	-
267700-7080	XU22TT	XU22TT
267700-7090	XUH22TT	XUH22TT
267700-7140	FK16HR11	IKH16TT
267700-7170	IXU22HPR	-
267700-7190	FK20HQR8	IKH20TT
267700-7260	FXU16HR11	-
267700-7370	IXUH22I	-
267700-7380	VXUH22I	-
267700-7390	DK20PR-D13	-
267700-7410	VFKH16	IKH16TT
267700-7420	VFKH20	IKH20TT
267700-7431	K16TT	K16TT
267700-7441	K20TT	K20TT
267700-7450	KH16TT	KH16TT
267700-7460	KH20TT	KH20TT
267700-7470	Q16TT	Q16TT
267700-7480	Q20TT	Q20TT
267700-7490	TV16TT	TV16TT
267700-7500	WF20TT	WF20TT
267700-7510	W22TT	W22TT
267700-7520	FXU22HR8	-
267700-7550	ZXU20HCR8	-
267700-7560	FXU22HR11	-
267700-7580	DXU22HCR-D11S	-
267700-7630	VFXEH20E	IXEH20ETT
267700-7640	VFXEH20	IXEH20TT
267700-7650	VFXEH22	IXEH22TT
267700-7660	VFKBH20	IKB20TT
267700-7670	VCH20	IXEH22TT
267700-7700	FK16HR-A8	-
267700-7780	FK16R-A8	-
267700-7800	DXE22HQR-D11S	-
267700-7820	T16TT	T16TT
267700-7830	T20TT	T20TT
267700-8130	SXU20HPR11	-
267700-8140	XU20HR9	-
267700-8170	IXUH20I	-
267700-8290	XUH20TTI	XUH20TTI
267700-8300	SC16HR11	IXEH20TT
267700-8440	VXU22I	-
267700-8590	FK16HBR-J8	-
267700-9150	VFK16	IK16TT
267700-9160	VFK20F	IK20TT
267700-9170	VXEBH27	-
267700-9430	IXU22I	-

EYQUEM	DENSO	TT
1000	W24FSR	-
1000C	W24S-U	-
1000CM	W22S-U	-
1000L	W24ESR-U	-
100M	W24FSR	-
1100	W27FSR	-
1100L	W24ESR-U	-
1150	W27FSR	-
1150L	W27ESR-U	-
200	W14F-U	-
202CT	W9LM-US	-
300A	W14L	-

EYQUEM	DENSO	TT
30AM	W14L	-
406	W16FSR	-
450L	W14E	-
480CS	W14PR-U	-
500	W16FSR	-
5002	W16FSR	-
500A	W16LS	-
500C	W20S-U	-
500CJT	T20M-U	-
500CM	W20S-U	-
500CS	W16PR-U	-
500CT	W20MR-U	-
500JS	T16PR-U	ITF16TT
500M	W16FSR	-
502	W16FSR	-
502CT	W14LM-US	-
505JS	T16PR-U	ITF16TT
50AM	W16LS	-
50M	W16FSR	-
520CS	W16PR-U	-
550CS	W16PR-U	-
550JS	T16PR-U	ITF16TT
550LS	W14EX-U	IW16TT
550S	W14FPR-U	-
580LS	W14EX-U	IW16TT
580S	W16FPR-U	-
600CS	W20PR-U	-
600JS	T20PR-U	ITF20TT
600L	W20ESR-U	-
600LS	W16EPR-U	W16TT
600S	W16FPR-U	-
700	W20FSR-U	WF20TT
700C	W20S-U	-
700CM	W20S-U	-
700CTS	W20MP-U	-
705L	W16ESR-U	-
705S	W20FPR-U	WF20TT
707LS	W16EPR-U	W16TT
70M	W20FSR-U	WF20TT
750	W20FSR-U	WF20TT
750L	W20ESR-U	-
750LS	W20EP-U	W20TT
753LJS	T20EPR-U	T20TT
755	W22FS-U	-
755C	W22S-U	-
755CJT	T22M-U	-
755CM	W20S-U	-
755CT	W22M-U	-
755L	W20ESR-U	-
755LJS	T20EPR-U	T20TT
755LJSP	IT20	IT20TT
755LS	W20EP-U	W20TT
755M	W20FSR-U	WF20TT
755S	W22FPR-U	-
755SX	W22FPR-U	-
755X	W22FS-U	-
75LM	W20ESR-U	-
75M	W20FSR-U	WF20TT
775SX	W20FPR-U	WF20TT
775X	W20FSR-U	WF20TT
800LJS	T20EPR-U	T20TT
800LS	W22EPR-U	W22TT
803LJS	T22EP-U	-
803LJSP	IT22	-
805L	W22ESR-U	-
805LJS	T22EP-U	-
805LJSP	IT24	-
805LP	IW24	-
850	W22FS-U	-
850LS	W22EPR-U	W22TT
883LJ	IT27	-

EYQUEM	DENSO	TT
883LJP	IT27	-
A-CL588S	DG-198	-
C30LS	W14EPR-U	IW16TT
C32	W16FSR	-
C32LS	W16EPR-U	W16TT
C32S	W16FPR-U	-
C42LJS3	T16EPR-U	T16TT
C42S	W20FPR-U	WF20TT
C52LJS	T20EPR-U	T20TT
C52LS	W16EPR-U	W16TT
C52LS3	W16EPB10	W16TT
C52LS3X	W16EPB10	W16TT
C62	W22FS-U	-
C62LJS	T20EPR-U	T20TT
C62LS	W20EP-U	W20TT
C62LS3X	W20EPB	W20TT
C62S	W22FPR-U	-
C72LJS	T22EP-U	-
C72LS	W22EPR-U	W22TT
C72LS3X	W22EPB	W22TT
C82LJS	T22EP-U	-
C82LS	W22EPR-U	W22TT
C82LS3X	W22EPB	W22TT
C83LJS	T22EP-U	-
C92LS	W24EPR-U	-
CD566R	DG-004	-
CD659R	DG-012	-
CD660R	DG-012	-
CD661R	DG-012	-
CD666R	DG-123	-
CD670T	DG-001	-
CD674V	DG-202	-
CL564P	DG-157	-
CL580P	DG-104	-
CL581S	DG-114	-
CL586T	DG-124	-
CL588S	DG-198	-
CT580T	DG-132	-
D1000	X24FS-U	-
D1000L	X27ESR-U	-
D1050L	X27ESR-U	-
D755	X20FSR-U	-
D775	X16FSR-U	-
D800L	X22ESR-U	-
D900L	X24ESR-U	-
DD6120V	DG-106	-
DD659R	DG-012	-
DD665T	DG-006	-
DD668S	DG-010	-
DD670T	DG-001	-
DD671T	DG-001	-
DD678S	DG-001	-
DT584T	DG-101	-
DT589V	DG-003	-
DT592T	DG-005	-
F100	W24FSR	-
F20	W14F-U	-
F220	W27FSR	-
F260	IWF27	-
F280	IWF27	-
F50	W16FSR	-
F55P	W16FPR-U	-
F65P	W20FPR-U	WF20TT
F70	W16FSR	-
F75	W20FSR-U	WF20TT
F75H	W20FSR-U	WF20TT
F80	W22FS-U	-
F85P	W20FPR-U	WF20TT
F86	IK22	-
F95P	W22FPR-U	-
FA50	W14L	-

Spark & Glow Plugs

Cross Reference Chart - Competitor

EYQUEM	DENSO	TT
FA70	W16LS	-
FC42LS	K16PR-U11	K16TT
FC42LS2E	K20TXR	K20TT
FC52LS	K20P-U	K20TT
FC58LS	K20P-U	K20TT
FC58LS2E	K20TXR	K20TT
FC58LS3	K20PBR	K20TT
FC62LS	K20P-U	K20TT
FC62LS3	K20PBR	K20TT
FC62LS3X	K20PBR	K20TT
FC72LS	K22PR-U	-
FC82LS	K22PR-U	-
FC82LS2	IK22	-
FC82LS3	K22PB	-
FE100	W24ESR-U	-
FE125P	W20EP-U	W20TT
FE135P	W22EPR-U	W22TT
FE145P	W24EPR-U	-
FE155P	W24EPR-U	-
FE220	IW24	-
FE260	IW27	-
FE280	IW29	-
FE285	IW31	-
FE310	IW01-32	-
FE320	IW34	-
FE35P	W14EPR-U	IW16TT
FE395	IW01-32	-
FE45P	W16EPR-U	W16TT
FE55P	W20EP-U	W20TT
FE65CPR	W20EPR-U	W20TT
FE65P	W20EP-U	W20TT
FE70	W20ESR-U	-
FE75	W22ESR-U	-
FE80	W22ESR-U	-
FE85P	W20EP-U	W20TT
FE95P	W22EPR-U	W22TT
FET65P	T20EPR-U	T20TT
FET75P	T22EP-U	-
FN52LS	W20EPR-U	W20TT
FS100	W24S-U	-
FS100H	W27S-U	-
FS20	W9-U	-
FS30	W14PR-U	-
FS35P	W14PR-U	-
FS45P	W16PR-U	-
FS50	W20S-U	-
FS55P	W20PR-U	-
FS70	W20S-U	-
FS75	W22S-U	-
FS75H	W22S-U	-
FSC50	W20M-US	-
FSC50P	W20MP-U	-
FSC70P	W20MP-U	-
FSC75P	W22MPR-U	-
FT55P	T16PR-U	TF16TT
FT65P	T16PR-U	TF16TT
FT85P	T20PR-U	TF20TT
GT4S	W16PR-U	-
GT4T	MA16PR-U	-
GT5	W16FPR-U	-
GT5L	W16EPR-U	W16TT
GT6	W20FPR-U	WF20TT
GT6L	W20EP-U	W20TT
GT6T	MA20P-U	-
GT7	W22FPR-U	-
GT7L	W22EPR-U	W22TT
GT8L	W24EPR-U	-
J65	IT20	IT20TT
J87	IT22	-
K200M	L14-U	-
K300JS	MA16PR-U	-

EYQUEM	DENSO	TT
K300M	M17	-
K450JS	MA16PR-U	-
K500M	M17	-
K550JS	MA20P-U	-
K600M	M22	-
K750M	M17	-
KC52JS	MA20P-U	-
KC62JS	MA20P-U	-
L3	IW16	IW16TT
L65	IW20	IW20TT
L87	IW22	-
M50	M17	-
M60	M17	-
M75	M22	-
M80	M24S	-
MT45P	MA16PR-U	-
MT55P	MA16PR-U	-
MT65P	MA20P-U	-
MT75P	MA20P-U	-
MT85P	MA20P-U	-
N43	IWF22	-
R1000	W24FSR	-
R1000L	W24ESR-U	-
R850	W22FSR	-
RC30LS	W14EPR-U	IW16TT
RC32LS	W16EPR-U	W16TT
RC32LS5	W16EPR-U11	W16TT
RC42S	W20FPR-U	WF20TT
RC52LJS	T20EPR-U	T20TT
RC52LJS5	T20EPR-U	T20TT
RC52LS	W20EPR-U	W20TT
RC52LS5	W20EPR-U11	W20TT
RC52LZ3EX	W20EPBR-S	W20TT
RC52LZE	J16CR-U	W16TT
RC58LZ3EX	W20EPBR-S	W20TT
RC62HJSDP	PT16VR13	TV16TT
RC62LJS	T20EPR-U	T20TT
RC62LJS5	T20EPR-U	T20TT
RC62LS	W20EPR-U	W20TT
RC62S	W22FPR-U	-
RC72LJS	T22EP-U	-
RC72LJS2	T22EP-U	-
RC72LJS3	T22EP-U	-
RC72LJS5	T22EP-U	-
RC72LS	W22EPR-U	W22TT
RC72LS5	W22EPR-U11	W22TT
RC82LS	W22EPR-U	W22TT
RC82LS5	W22EPR-U11	W22TT
RFC32LZ5	K16R-U11	K16TT
RFC42LS	K16PR-U	K16TT
RFC42LS2E	K20TXR	K20TT
RFC42LS5	K16PR-U11	K16TT
RFC42LS6	Q16PR-U11	Q16TT
RFC42LZ2E	K20TXR	K20TT
RFC50LZ2E	K20TXR	K20TT
RFC52LS	K20PR-U	K20TT
RFC52LS2E	K20TXR	K20TT
RFC52LS3	K20PBR	K20TT
RFC52LS5	K20PR-U11	K20TT
RFC52LSP	PK20PR11	K20TT
RFC52LZ3EX	K20PBR-S10	K20TT
RFC52LZDP6	PK20R13	K20TT
RFC52LZE	K16R-U	K16TT
RFC57LS3	K20PBR	K20TT
RFC58LS	K20PR-U	K20TT
RFC58LS2E	K20TXR	K20TT
RFC58LS3	K20PBR	K20TT
RFC58LS5	K20PR-U11	K20TT
RFC58LSP	PK20PR11	K20TT
RFC58LZ	Q20PR-U	Q20TT
RFC58LZ2	K20TNR	K20TT

EYQUEM	DENSO	TT
RFC58LZ2E	K20TXR	K20TT
RFC58LZ3EX	K20PBR-S10	K20TT
RFC58LZ5	K20R-U11	K20TT
RFC58LZDP	PK20PR-P8	IK20TT
RFC58LZE5	KJ20CR-L11	K20TT
RFC58LZK	K20PR-U	K20TT
RFC62LS	K22PR-U	-
RFC62LS3	K22PBR-S	-
RFC62LS3X	K22PBR-S	-
RFC62LS5	K22PR-U11	-
RFC62LZ3EX	K22PBR-S	-
RFC82LS	K22PR-U	-
RFC82LS3	K22PBR-S	-
RFC82LS5	K22PR-U11	-
RFN42LZG5	QJ16AR-U	-
RFN52HZ	K16HPR-U11	KH16TT
RFN52HZ3A	K16HPR-U11	KH16TT
RFN52LZ	K16PR-U	K16TT
RFN52LZDPF5	PKJ16CR-L11	IK16TT
RFN58HZ	K20HR-U11	KH20TT
RFN58LZ	K20PR-U	K20TT
RFN62LZ	K22PR-U	-
RKC62JS	MA20PR-U	-
RKC62JS	MA20PR-U	-
T30	U20FSR-U	-
T70	U22FSR-U	-
T850	U22FSR-U	-
T90	U24FSR-U	-
TW270	X20FSR-U	-
TW275	X20FSR-U	-
TW280	X24FS-U	-
TWE270	X24ESR-U	-
TWE275	X27ESR-U	-
XC30LS	W14EPR-U	IW16TT
XC32LS	W16EPR-U	W16TT
XC42S	W20FPR-U	WF20TT
XC52LS	W16EPR-U	W16TT
XC62LJS	T20EPR-U	T20TT
XC62LS	W20EPR-U	W20TT
XC62S	W22FPR-U	-
XC72LJS	T22EP-U	-
XC72LS	W22EPR-U	W22TT
XFC62LS	K22PR-U	-
XFC82LS	K22PR-U	-
XKC52JS	MA20PR-U	-
XKC62JS	MA20PR-U	-

HKS	DENSO	TT
M35	IQ22	-
M35G	IW22	-
M35i	IK22	-
M35iL	IKH22	-
M35LF	ITV22	-
M40	IQ24	-
M40G	IW24	-
M40i	IK24	-
M40iL	IKH24	-
M40LF	ITV24	-
M40X	IXU24	-
M45	IQ27	-
M45G	IW27	-
M45i	IK27	-
M45iL	IKH27	-
M45RE	IRE01-27	-
M45REL	IRL01-27	-
M45X	IXU27	-
M50RE	IRE01-31	-
M50RET	IRT01-31	-
M525RE	IRE01-32	-
M55RE	IRE01-34	-
R45	IQ01-27	-

HKS	DENSO	TT
R45i	IK01-27	-
R45RE	IRE01-27	-
R50	IQ01-31	-
R50i	IK01-31	-
R50RE	IRE01-31	-
R525RE	IRE01-32	-
R55	IQ01-34	-
R55i	IK01-34	-
R55RE	IRE01-34	-
S30	IQ20	IQ20TT
S30i	IK20	IK20TT
S35	IQ22	-
S35G	IW22	-
S35i	IK22	-
S35iL	IKH22	-
S40	IQ24	-
S40G	IW24	-
S40i	IK24	-
S40iL	IKH24	-
S40X	IXU24	-
S45	IQ27	-
S45G	IW27	-
S45i	IK27	-
S45iL	IKH27	-
S45X	IXU27	-
S50	IQ31	-
S50i	IK31	-
S55	IQ34	-
S55i	IK34	-

ISKRA	DENSO	TT
F100	W24FSR	-
F100RS	W24FSR	-
F100S	W24FSR	-
F20	W14F-U	-
F45P	W14FPR-U	-
F50	W16FSR	-
F55P	W16FPR-U	-
F55PRS	W16FPR-U	-
F55PS	W16FPR-U	-
F65CP	W20FPR-U	WF20TT
F65CPR	W20FPR-U	WF20TT
F65P	W20FPR-U	WF20TT
F65PR	W20FPR-U	WF20TT
F65PRS	W20FPR-U	WF20TT
F65PS	W20FPR-U	WF20TT
F70	W20FSR-U	WF20TT
F75	W20FSR-U	WF20TT
F75RS	W20FSR-U	WF20TT
F75S	W20FSR-U	WF20TT
F80	W22FS-U	-
F80C	W22FS-U	-
F80S	W22FS-U	-
F85CP	W20FPR-U	WF20TT
F85P	W20FPR-U	WF20TT
F85PS	W20FPR-U	WF20TT
F95P	W22FPR-U	-
F95PS	W22FPR-U	-
FE100	W27ESR-U	-
FE100RS	W27ESR-U	-
FE100S	W27ESR-U	-
FE125P	W20EP-U	W20TT
FE135P	W22EPR-U	W22TT
FE145P	W24EPR-U	-
FE155P	W24EPR-U	-
FE220	W27ESR-U	-
FE35P	W14EPR-U	IW16TT
FE45P	W16EPR-U	W16TT
FE50	W16ESR-U	-
FE55P	W16EPR-U	W16TT
FE55PRS	W16EPR-U	W16TT

Spark & Glow Plugs

Cross Reference Chart - Competitor

ISKRA	DENSO	TT
FE55PS	W16EPR-U	W16TT
FE55PTRS	W16ETR-S	W16TT
FE55PTS	W16EPB10	W16TT
FE65CP	W20EP-U	W20TT
FE65CPD	W20EPB	W20TT
FE65CPR	W20EPR-U	W20TT
FE65PR	W20EPR-U	W20TT
FE65PRS	W20EPR-U	W20TT
FE65PS	W20EP-U	W20TT
FE65PTRS	W20EPBR-S	W20TT
FE65PTS	W20EPB	W20TT
FE70	W20ESR-U	-
FE75	W22ESR-U	-
FE75RS	W22ESR-U	-
FE75S	W22ESR-U	-
FE80	W24ESR-U	-
FE80RS	W24ESR-U	-
FE80S	W24ESR-U	-
FE85CP	W22EPR-U	W22TT
FE85CPR	W22EPR-U	W22TT
FE85CPR11	W22EPR-U11	W22TT
FE85P	W22EPR-U	W22TT
FE85PR	W22EPR-U	W22TT
FE85PR11	W22EPR-U11	W22TT
FE85PRS	W22EPR-U	W22TT
FE85PS	W22EPR-U	W22TT
FE85PTRS	W22EPB	W22TT
FE85PTS	W22EPB	W22TT
FE95CP	W24EPR-U	-
FE95CPR	W24EPR-U	-
FE95P	W22EPR-U	W22TT
FE95PR	W22EPR-U	W22TT
FET55PRS	T16EPR-U	T16TT
FET55PS	T16EPR-U	T16TT
FET65P	T20EPR-U	T20TT
FET65PRS	T20EPR-U	T20TT
FET65PS	T20EPR-U	T20TT
FET75CP	T22EP-U	-
FET75CPR	T22EP-U	-
FET75P	T22EP-U	-
FET75PRS	T22EP-U	-
FET75PS	T22EP-U	-
FS100	W24S-U	-
FS100H	W27S-U	-
FS20	W9-U	-
FS30	W14PR-U	-
FS30LM	W14LM-US	-
FS30LMR	W14LM-U	-
FS35P	W14PR-U	-
FS45P	W16PR-U	-
FS50	W16S-U	-
FS50C	W20M-US	-
FS55P	W20PR-U	-
FS70	W20S-U	-
FS70C	W20MP-U	-
FS75	W22S-U	-
FS75C	W22MPR-U	-
FS75H	W22S-U	-
FSC50	W20M-US	-
FSC50P	W20MP-U	-
FSC50R	W20MR-U	-
FSC70P	W20MP-U	-
FSC75CP	W22MPR-U	-
FSC75CPR	W22MPR-U	-
FSC75P	W22MPR-U	-
FT55P	T16PR-U	ITF16TT
FT65P	T20PR-U	ITF20TT
FT65PR	T20PR-U	ITF20TT
FT65PS	T20PR-U	ITF20TT
FT85P	T20PR-U	ITF20TT
GT4S	W16PR-U	-

ISKRA	DENSO	TT
GT4T	MA16PR-U	-
GT5	W16FPR-U	-
GT5L	W16EPR-U	W16TT
GT6	W20FPR-U	WF20TT
GT6L	W20EP-U	W20TT
GT6T	MA20P-U	-
GT7	W22FPR-U	-
GT7L	W22EPR-U	W22TT
GT8L	W24EPR-U	-
M50	M14	-
M60	M17	-
M75	M22	-
M80	M24S	-
MT45P	MA16PR-U	-
MT55P	MA16PR-U	-
MT65CP	MA20P-U	-
MT65P	MA20P-U	-
MT65PRS	MA20PR-U	-
MT65PS	MA20P-U	-
MT75P	MA20P-U	-
MT85P	MA20P-U	-
SFE55LDRS	K20TXR	K20TT
SFE55LRS	KJ16CR-L11	K16TT
SFE55LS	KJ16CR-L11	K16TT
SFE55PRS	Q16PR-U	Q16TT
SFE55PS	Q16PR-U11	Q16TT
SFE55PTRS	K20PBR-S10	K20TT
SFE55PTS	K20PBR	K20TT
SFE65CPR	Q20PR-U	Q20TT
SFE65LDRS	K20TXR	K20TT
SFE65LDS	K20TXR	K20TT
SFE65LRS	KJ20CR-L11	K20TT
SFE65LTS	K20PBR	K20TT
SFE65PRS	Q20PR-U	Q20TT
SFE65PS	Q20PR-U	Q20TT
SFE65PTRS	K20PBR	K20TT
SFE65PTS	K20PBR	K20TT
SFE85CPR	Q22PR-U	-
SFE85LDRS	K20TNR	K20TT
SFE85LTS	K22PB	-
SFE85PRS	Q22PR-U	-
SFE85PS	Q22PR-U	-
SFE85PTRS	K22PBR-S	-
SFE85PTS	K22PB	-
T30	U20FSR-U	-
T70	U22FSR-U	-
T90	U24FSR-U	-
TW270	X20FSR-U	-
TW275	X20FSR-U	-
TW280	X24FS-U	-
TWE270	X24ESR-U	-
TWE275	X27ESR-U	-

KITAHARA	DENSO	TT
B-032	DG-123	-
B-040	DG-001	-
CP-02	DG-304	-
CP-07	DG-301	-
CP-50	DG-300	-
CP-51	DG-302	-
CP72	DG-197	-
PI-46	DG-143	-
PI-49	DG-108	-
PI-57	DG-104	-
PI-58	DG-124	-
PM-161	DG-162	-
PM167	DG-174	-
PM168	DG-187	-
PM-75	DG-198	-
PN-132	DG-157	-
PN-138	DG-137	-

KITAHARA	DENSO	TT
PN-81	DG-127	-
PN-89	DG-012	-
PZ-33	DG-114	-
PZ704	DG-502	-

LODGE	DENSO	TT
25HL	W22EPR-U	W22TT
25HLD	Q22PR-U	-
2HL	W22EPR-U	W22TT
2HLD	Q22PR-U	-
2HLDR	K22PBR-S	-
2HLN	W22ESR-U	-
3HLN	W24ESR-U	-
B4Y	T22EP-U	-
B6Y	T20EPR-U	T20TT
B6YR	T20EPR-U	T20TT
CNY	W16FPR-U	-
HBANC	W20M-US	-
HBANCY	W20MPR-U10	-
HBLT	T20EPR-U	T20TT
HL	W20EP-U	W20TT
HLD	Q20PR-U	Q20TT
HLT	T22EP-U	-
L4Y	W22EPR-U	W22TT
L4YR	W22EPR-U	W22TT
L5	W22ESR-U	-
L6Y	W20EP-U	W20TT
L6YR	W20EPR-U	W20TT
M5Y	Q22PR-U	-
M5YR	Q22PR-U	-
M6Y	Q20PR-U	Q20TT
M6YR	Q20PR-U	Q20TT
R49	IWF24	-
R50	IWF24	-
R51	IWF27	-
RL47	IW24	-
RL49	IW27	-
RL51	IW31	-
RL52	IW34	-
S3	W24FSR	-
S5	W22FS-U	-
S6	W20FSR-U	WF20TT
S6Y	W20FPR-U	WF20TT
S6YR	W20FPR-U	WF20TT

LPM	DENSO	TT
0001521000	W16S-U	-
0001521001	W14PR-U	-
0001521002	W9-U	-
0001521003	W14L	-
0001521012	W16ES-U	-
0001521014	W14EX-U	IW16TT
0001521015	M17	-
0001521019	L14-U	-
0001521033	W16EXR-U	W16TT
0001522036	W20EX-U	W20TT
0001522095	T16P-U	ITF16TT
0001522158	T20PR-U	ITF20TT
0001523029	W9EP	-
0001523030	W16EX-U	W16TT
0001523032	T16PR-U	ITF16TT
0001523033	T14PR-U	ITF16TT
0001523034	W14EPR-U	IW16TT
0001523036	T20R-U	-
0001523037	W9EXR-U+CU	-
0001523038	T16NR-U11	IT16TT
0001523039	T16R-U	IT16TT
0001523040	T16PR-U11	ITF16TT
0001523041	MA20PR-U	-
0001523042	W22EPR-U	W22TT
0001523043	W14EXR-U	IW16TT

LPM	DENSO	TT
0001523044	PT16EPR-L13	IT16TT
0001523045	K16PR-U	K16TT
0001523046	K16R-U	K16TT
0001523047	MA16PR-U	-
0001523048	W24EP-U	-
0001523049	W20EXR-U	W20TT
0001525022	T16EPR-U	T16TT
0001526046	W9EX-U	-

LUCAS ELECTRICAL	DENSO	TT
LP022	DG-012	-
LP027	DG-005	-
LP033	DG-001	-
LP037	DG-003	-
LP043	DG-109	-
LP051	DG-116	-
LP055	DG-117	-
LP062	DG-121	-
LP067	DG-174	-
LP072	DG-122	-
LP074	DG-130	-
LP076	DG-302	-
LP077	DG-142	-
LP087	DG-177	-
LP098	DG-171	-
LP101	DG-170	-

MAGNETI MARELLI	DENSO	TT
75LMCR	K20TNR	K20TT
7LC	Q20PR-U	Q20TT
7LC1R	Q20PR-U11	Q20TT
7LCR	Q20PR-U	Q20TT
7LPR	Q20PR-U	Q20TT
8LC	Q22PR-U	-
8LCR	Q22PR-U	-
8LDCR	PT16VR13	TV16TT
8LPR	Q22PR-U	-
9LC	Q22PR-U	-
AW56C	W20M-US	-
AW5C	W20M-US	-
CM3N	M14	-
CM4N	M17	-
CM5N	M17	-
CM6N	M22	-
CU7N	U20FSR-U	-
CW101L	W27ESR-U	-
CW10L	W27ESR-U	-
CW10N	W27FSR	-
CW11L	W27ESR-U	-
CW12L	IW31	-
CW12N	W31FS	-
CW12NV	SF-50	-
CW13L	W31ESR-U	-
CW14L	W31ESR-U	-
CW15L	IW34	-
CW2C	W9-U	-
CW2CJ	W9-U	-
CW2L	W9EP	-
CW3C	W9-U	-
CW3CJ	W9-U	-
CW3L	W9EP	-
CW4C	W14PR-U	-
CW4CJ	W14PR-U	-
CW4CP	W14PR-U	-
CW4L	W14E	-
CW4LP	W14EPR-U	IW16TT
CW4N	W14F-U	-
CW55N	W16FSR	-
CW5C	W16S-U	-
CW5CP	W16PR-U	-
CW5L	W16ESR-U	-

Spark & Glow Plugs

Cross Reference Chart - Competitor

MAGNETI MARELLI	DENSO	TT
CW5LP	W16EPR-U	W16TT
CW5LS	W16ESR-U	-
CW5LSZ	W16ESR-U	-
CW5N	W16FSR	-
CW5NJ	W16FSR	-
CW5NP	W16FPR-U	-
CW5NR	W16FSR	-
CW5NS	W16FSR	-
CW67L	W20ESR-U	-
CW67LP	W20EP-U	W20TT
CW67N	W20FSR-U	WF20TT
CW67NR	W20FSR-U	WF20TT
CW67P	W20EP-U	W20TT
CW6C	W16S-U	-
CW6CE	W20M-US	-
CW6CJ	W16S-U	-
CW6L	W16ESR-U	-
CW6LP	W16EPR-U	W16TT
CW6LR	W16ESR-U	-
CW6LS	W16ESR-U	-
CW6LSZ	W16ESR-U	-
CW6N	W20FSR-U	WF20TT
CW6NE	W20M-US	-
CW6NJ	W20M-US	-
CW6NP	W20FPR-U	WF20TT
CW6NPR	W20FPR-U	WF20TT
CW6NR	W20FSR-U	WF20TT
CW75LP	W20EP-U	W20TT
CW78L	W20ESR-U	-
CW78LP	W20EP-U	W20TT
CW78LPR	W20EPR-U	W20TT
CW78LPS	W20EPR-S11	W20TT
CW7C	W20S-U	-
CW7L	W20ESR-U	-
CW7LCR	Q20PR-U	Q20TT
CW7LJ	W20ESR-U	-
CW7LP	W20EP-U	W20TT
CW7LPH	W20EP-U	W20TT
CW7LPR	W20EPR-U	W20TT
CW7LR	W20ESR-U	-
CW7N	W20FSR-U	WF20TT
CW7NJ	W20FSR-U	WF20TT
CW7NP	W20FPR-U	WF20TT
CW7NPR	W20FPR-U	WF20TT
CW7NR	W20FSR-U	WF20TT
CW89LP	W22EPR-U	W22TT
CW8CJ	W22S-U	-
CW8L	W22ESR-U	-
CW8LCR	Q22PR-U	-
CW8LJ	W22ESR-U	-
CW8LP	W22EPR-U	W22TT
CW8LPR	W22EPR-U	W22TT
CW8LPS	W22EPR-U	W22TT
CW8N	W22FS-U	-
CW8NP	W22FPR-U	-
CW8NR	W22FSR	-
CW9L	W24ESR-U	-
CW9LP	W24EPR-U	-
CW9N	W24FSR	-
CW9NJ	W24FSR	-
CWC12NJ	W31FS	-
CWC67NJ	W20FSR-U	WF20TT
CWC6NJ	W16FSR	-
CWC7NJ	W20FSR-U	WF20TT
CWC9NJ	W24FSR	-
CWF11L	IW27	-
CWP10L	IW27	-
CWP10N	IWF27	-
CWP11L	IW31	-
CWP7L	IW20	IW20TT
CWP7N	IWF22	-

MAGNETI MARELLI	DENSO	TT
CWP8L	IW24	-
CWP8N	IWF22	-
CWP9L	IW24	-
CWP9N	IWF24	-
CX6N	X20FSR-U	-
CX8L	X22ESR-U	-
DW4CJ	W14LM-US	-
DW4CJR	W14LM-U	-
F45LCR	W16EPR-U	W16TT
F45LDCR	W16EPR-U	W16TT
F4LC	W16EPR-U	W16TT
F4LCR	W16EPR-U	W16TT
F6LMC1R	W20EPBR-S	W20TT
F6NC	W16FPR-U	-
F6NCR	W16FPR-U	-
F75LMC1R	W20EPBR-S	W20TT
F7CN	W20FSR-U	WF20TT
F7LC	W20EP-U	W20TT
F7NC	W20FPR-U	WF20TT
F7NCR	W20FPR-U	WF20TT
F8LC	W22EPR-U	W22TT
FC6N	W16FSR	-
FC7N	W20FSR-U	WF20TT
FC8L	W22EPR-U	W22TT
FC9L	W24EPR-U	-
FL7LCR	W20EPR-U	W20TT
FL7MCR	W20EPBR-S	W20TT
FL8LCR	W22EPR-U	W22TT
FL8LNCR	W20EXR-U	W20TT
L10BPCPR	IU22	-
L10CR	XU24EPR-U	-
L10DCR	XU24EPR-U	-
L7LCD1R	Q20PR-U11	Q20TT
L7LCR	Q20PR-U	Q20TT
L7LDCR	K20PR-U	K20TT
L7MCR	K20PBR	K20TT
L8LCR	Q22PR-U	-
L9LPCPR	PK22PR8	-
SW5C	T20M-U	-
T7LC	T20EPR-U	T20TT
T7LCR	T20EPR-U	T20TT
T8LC	T22EP-U	-
T8LCR	T22EP-U	-
T8LDC	T22EP-U	-
TIX1A	DG-012	-
TIX2A	DG-001	-
TIX7A	DG-202	-
TM2NP	MA16PR-U	-
TM3NP	MA16PR-U	-
TM4NP	MA20P-U	-
TW4LP	T16EPR-U	T16TT
TW5NP	T16PR-U	TF16TT
TW6NP	T16PR-U	TF16TT
TW78LP	T20EPR-U	T20TT
TW78LPR	T20EPR-U	T20TT
TW78NPR	T20PR-U	TF20TT
TW7LP	T20EPR-U	T20TT
TW7LPR	T20EPR-U	T20TT
TW7NP	T20PR-U	TF20TT
UC10A	DG-124	-
UC11A	DG-127	-
UC12A	DG-116	-
UC13A	DG-101	-
UC14A	DG-109	-
UC15A	DG-003	-
UC16A	DG-118	-
UC17A	DG-117	-
UC18A	DG-155	-
UC21A	DG-008	-
UC2A	DG-132	-
UC3A	DG-005	-

MAGNETI MARELLI	DENSO	TT
UC4A	DG-102	-
UC7A	DG-003	-
UC8A	DG-101	-
UC9A	DG-104	-
UX11A	DG-004	-
UX12A	DG-123	-
UX14A	DG-006	-
UX15A	DG-001	-
UX16A	DG-119	-
UX17A	DG-106	-
UX18A	DG-012	-
UX19A	DG-007	-
UX20A	DG-001	-
UX21A	DG-129	-
UX2A	DG-001	-
UX4A	DG-001	-
UX7A	DG-202	-
UX8A	DG-012	-
UX9A	DG-001	-

MOTORCRAFT	DENSO	TT
1Y0018110	W16EPR-U	W16TT
1Y0118110	W20EPR-U	W20TT
1Y0318110	W16EPR-U11	W16TT
1Y0618110	K16PR-U	K16TT
1Y0718110	K20PR-U	K20TT
1Y0918110	K16PR-U11	K16TT
1Y0A18110	K20PR-U11	K20TT
1Y0B18110	K22PR-U11	-
1Y0F18110	XU22EPR-U	XU22TT
1Y0G18110	KJ16CR-L11	K16TT
1Y0H18110	KJ20CR-L11	K20TT
1Y0K18110	W16EXR-U13	W16TT
1Y0L18110	J16AR-U11	-
1YR118110	VW20	IW20TT
1YR718110	VK20	IK20TT
1YR918110	VK16	IK16TT
1YRA18110	VK20	IK20TT
1YRF18110	VXU22	-
1YRG18110	VK16	IK16TT
1YRH18110	VK20	IK20TT
A11	W9-U	-
A11LM	W14LM-U	-
A11X	W9-U	-
A21X	W24S-U	-
A22	W20PR-U	-
A22NX	W22MPR-U	-
A2C	W24S-U	-
A2NX	W22M-U	-
A32	W20PR-U	-
A3NX	W22M-U	-
A3X	W20S-U	-
A42	W16PR-U	-
A42C	W16PR-U	-
A42N	W16S-U	-
A5	W16S-U	-
A52	W14PR-U	-
A5X	W16S-U	-
A7	W14PR-U	-
A7C	W14PR-U	-
A7CLM	W14LM-U	-
A7CX	W14PR-U	-
A7LM	W14LM-U	-
A7NX	W20MR-U	-
A7X	W14PR-U	-
A82	W9PR-U	-
A9	W9-U	-
A901	W27S-U	-
A9X	W9-U	-
AE091	IWF27	-
AE1C	W22FS-U	-

MOTORCRAFT	DENSO	TT
AE1X	W22FS-U	-
AE22	W22FPR-U	-
AE22C	W22FPR-U	-
AE23	IWF24	-
AE2C	W22FS-U	-
AE2X	W22FS-U	-
AE3	W20FSR-U	WF20TT
AE32	W20FPR-U	WF20TT
AE32C	W20FPR-U	WF20TT
AE3C	W20FSR-U	WF20TT
AE3X	W20FSR-U	WF20TT
AE4	W16FSR	-
AE42	W16FPR-U	-
AE42C	W16FPR-U	-
AE4X	W16FSR	-
AE6	W14F-U	-
AE901	W24FSR	-
AE901X	W24FSR	-
AE903	IWF27	-
AER22C	W22FPR-U	-
AER2X	W22FSR	-
AER32	W20FPR-U	WF20TT
AER4	W16FSR	-
AER4X	W16FSR	-
AER6	W14FR-U	-
AES4C	W16FSR	-
AF22	T20PR-U	ITF20TT
AF32	T20PR-U	ITF20TT
AF3NX	T22M-U	-
AF42	T16PR-U	ITF16TT
AF42C	T16PR-U	ITF16TT
AF52	T16PR-U	ITF16TT
AF52C	T16PR-U	ITF16TT
AF5NX	T20M-U	-
AF701	ITF27	-
AF901	ITF24	-
AG040	IW31	-
AG051	W31ESR-U	-
AG071	W27ESR-U	-
AG091	W24ESR-U	-
AG092C	W24ESR-U	-
AG1	W24ESR-U	-
AG12	W24EPR-U	-
AG12C	W24EPR-U	-
AG1C	W24ESR-U	-
AG1CX	W24ESR-U	-
AG1X	W22ESR-U	-
AG2	W22ESR-U	-
AG200	IW34	-
AG203	IW34	-
AG22	W22EPR-U	W22TT
AG22C	W22EPR-U	W22TT
AG22CT	W20EPB	W20TT
AG23	IW24	-
AG2C	W22ESR-U	-
AG2CX	W22ESR-U	-
AG2X	W22ESR-U	-
AG3	W20ESR-U	-
AG303	IW34	-
AG32	W20EP-U	W20TT
AG32A	W20EP-U	W20TT
AG32C	W20EX-U	W20TT
AG32CT	W20EPB	W20TT
AG32CT1	W20EPB	W20TT
AG34	W20EX-U	W20TT
AG3C	W20ESR-U	-
AG3CX	W20ESR-U	-
AG3X	W20ESR-U	-
AG4	W16ESR-U	-
AG400	IW31	-
AG403	IW31	-

Spark & Glow Plugs

Cross Reference Chart - Competitor

MOTORCRAFT	DENSO	TT
AG42C	W16EPR-U	W16TT
AG44	KJ16CR-L11	K16TT
AG44CU	W16EXR-U	W16TT
AG5	W16ESR-U	-
AG501	W31ESR-U	-
AG501X	W31ESR-U	-
AG52	W14EPR-U	IW16TT
AG52C	W14EX-U	IW16TT
AG54	KJ16CR-L11	K16TT
AG600	IW01-27	-
AG603	W27ESR-U	-
AG7	W14E	-
AG701	W27ESR-U	-
AG701C	W27ESR-U	-
AG701X	W27ESR-U	-
AG82	W9EP	-
AG9	W14E	-
AG901	W24ESR-U	-
AG901C	W24ESR-U	-
AG901CU	W24ESR-U	-
AG901X	W24ESR-U	-
AG902	W24EPR-U	-
AG903	IW24	-
AGF12C	T22EP-U	-
AGF22	T20EPR-U	T20TT
AGF22C	T20EPR-U	T20TT
AGFS22C1	T20EPR-U	T20TT
AGFS22FE13J	T20EPR-U	T20TT
AGFS22IPJ	VT20	IT20TT
AGFS32C1	T20EPR-U	T20TT
AGN42	W16EXR-U	W16TT
AGP12C	K22PR-U	-
AGP22C	K20P-U	K20TT
AGP22CD	Q20PR-U	Q20TT
AGPR12C	K22PR-U	-
AGPR12P	IK20	IK20TT
AGPR12P1	IK20	IK20TT
AGPR12PP	PK20PR-P11	K20TT
AGPR12PP11	PK20PR-P11	K20TT
AGPR12PP8	PK20PR-P8	IK20TT
AGPR22C	K20PR-U	K20TT
AGPR22C1	K20PR-U11	K20TT
AGPR22CD	Q20PR-U	Q20TT
AGPR22CD1	Q20PR-U11	Q20TT
AGPR22P	IK20	IK20TT
AGPR22P1	IK20	IK20TT
AGPR22PP	PK20PR11	K20TT
AGPR22PP8	PK20PR-P8	IK20TT
AGPR22PPJ	PK20PR11	K20TT
AGPR32C	K20PR-U	K20TT
AGPR32C1	K20PR-U11	K20TT
AGPR32CD	Q20PR-U	Q20TT
AGPR32CD1	Q20PR-U11	Q20TT
AGPR32PD	PK16PR-P11	K16TT
AGPR601P	IK31	-
AGPR701C	IK27	-
AGPR702C	IK27	-
AGPR901C	IQ24	-
AGPR901C1	IK24	-
AGPR902C	IQ27	-
AGPR902C1	K24PR-U11	-
AGPR902P	IQ27	-
AGR12	W24EPR-U	-
AGR12C	W24EPR-U	-
AGR16C	W27EBR	-
AGR1C	W22ESR-U	-
AGR1X	W22ESR-U	-
AGR21	W22ESR-U	-
AGR22	W22EPR-U	W22TT
AGR22C	W22EPR-U	W22TT
AGR2C	W22ESR-U	-

MOTORCRAFT	DENSO	TT
AGR2X	W22ESR-U	-
AGR31	W20ESR-U	-
AGR32	W20EPR-U	W20TT
AGR32C	W20EXR-U	W20TT
AGR34CU	W20EXR-U	W20TT
AGR34CU11	W20EXR-U11	W20TT
AGR3X	W20ESR-U	-
AGR41	W16ESR-U	-
AGR42	W16EPR-U	W16TT
AGR42C	W16EXR-U	W16TT
AGR44	J16BR-U	-
AGR44C1	W16EXR-U11	W16TT
AGR44CU	W16EXR-U	W16TT
AGR47CU11	J16AR-U11	-
AGR51	W16ESR-U	-
AGR52	W14EXR-U	IW16TT
AGR526	W14EXR-U11	IW16TT
AGR52A	W14EPR-U	IW16TT
AGR52C6	W14EXR-U11	IW16TT
AGR54	J16BR-U	-
AGR701X	W27ESR-U	-
AGR803C	W27ESR-U	-
AGR82	W14EXR-U	IW16TT
AGR901X	W24ESR-U	-
AGRF12C	T20EPR-U	T20TT
AGRF2	T20EPR-U	T20TT
AGRF22	T20EPR-U	T20TT
AGRF226	T20EPR-U15	T20TT
AGRF22C	T20EPR-U	T20TT
AGRF22C1	T20EPR-U	T20TT
AGRF22CD	T20EPR-U	T20TT
AGRF22PP	T20EPR-U	T20TT
AGRF32	T20EPR-U	T20TT
AGRF326	T20EPR-U15	T20TT
AGRF32C1	T20EPR-U	T20TT
AGRF42	T16EPR-U	T16TT
AGRF42C1	T16EPR-U	T16TT
AGRF42C6	T16EPR-U15	T16TT
AGRF52	T16EPR-U	T16TT
AGRP44	T20EPR-U	T20TT
AGS081C	W27ESR-U	-
AGS12C	W22EPR-U	W22TT
AGS1C	W22ESR-U	-
AGS22C	W22EPR-U	W22TT
AGS2C	W22ESR-U	-
AGS32C	W16EXR-U11	W16TT
AGS32C1	W16EXR-U11	W16TT
AGS3C	W20ESR-U	-
AGS42C	W16EXR-U	W16TT
AGS44	J16BR-U	-
AGS4C	W16ESR-U	-
AGS52C	W14EXR-U	IW16TT
AGS52C6	W14EXR-U11	IW16TT
AGSF2	T22EP-U	-
AGSF22C	T20EPR-U	T20TT
AGSF22FCM	PT16EPR-L13	IT16TT
AGSF22FM1	PT16EPR-L13	IT16TT
AGSF22FSM	VT20	IT20TT
AGSF22IPJ	IT20	IT20TT
AGSF22PP	PT16EPR-L13	IT16TT
AGSF22PPJ	VT20	IT20TT
AGSF22PPM	VT20	IT20TT
AGSF22WMM	VT20	IT20TT
AGSF24C	T20EPR-U	T20TT
AGSF24FM	IT20	IT20TT
AGSF24FN	IT20	IT20TT
AGSF24N	T20EPR-U	T20TT
AGSF24PGM	VT20	IT20TT
AGSF24PN	IT20	IT20TT
AGSF32C	T20EPR-U	T20TT
AGSF32FEC	IT16	IT16TT

MOTORCRAFT	DENSO	TT
AGSF32FM	ZT20EPR11	T20TT
AGSF32M	T16EPR-U15	T16TT
AGSF32P	IT20	IT20TT
AGSF32PM	IT20	IT20TT
AGSF32W	T16EPR-U15	T16TT
AGSF32WMM	T16EPR-U15	T16TT
AGSF33C	T20EPR-U	T20TT
AGSF34C	T20EPR-U	T20TT
AGSF34EE	T20EPR-U	T20TT
AGSF34EEM	T20EPR-U	T20TT
AGSF34FM	T20EPR-U	T20TT
AGSF34FP	PT16EPR-L13	IT16TT
AGSF42	T16EPR-U	T16TT
AGSF42C6	T16EPR-U15	T16TT
AGSF42EEM	PT16EPR-L13	IT16TT
AGSF42FM	IT16	IT16TT
AGSF44FM	IT16	IT16TT
AGSF52C	T16EPR-U	T16TT
AGSP22Z11	IK20	IK20TT
AGSP32C	K16PR-U11	K16TT
AGSP32FP	VK16	IK16TT
AGSP32FSM	VK16	IK16TT
AGSP32P	PQ16R	Q16TT
AGSP32PP	PQ16R	Q16TT
AGSP32Z	IK16	IK16TT
AGSP52C	K16PR-U11	K16TT
AGSP54	KJ16CR-L11	K16TT
AL11	W14L	-
AL5	W16LS	-
AL5X	W16LS	-
AL7	W14L	-
AL7C	W14L	-
AL7X	W14L	-
AL82	W14L	-
AL9	W14L	-
AL9X	W14L	-
AR31	W20SR-U	-
AR32	W20PR-U	-
AR41	W20SR-U	-
AR42	W16PR-U	-
AR426	W16PR-U	-
AR52	W14PR-U	-
AR526	W14PR-U	-
AR5S	W20SR-U	-
AR82	W9PR-U	-
AR826	W9PR-U	-
AR828	W9PR-U	-
AR82S	W9PR-U	-
AR86	T16R-U	IT16TT
ARF2	T20R-U	-
ARF22	T20PR-U	ITF20TT
ARF22C	T20PR-U	ITF20TT
ARF26	T20R-U	-
ARF3	T20R-U	-
ARF32	T20PR-U	ITF20TT
ARF326	T20PR-U15	ITF20TT
ARF32C6	T20PR-U15	ITF20TT
ARF32M	T20PR-U	ITF20TT
ARF36	T20R-U	-
ARF3C	T20R-U	-
ARF4	T20R-U	-
ARF42	T16PR-U	ITF16TT
ARF426	T16PR-U15	ITF16TT
ARF428	T16PR-U15	ITF16TT
ARF42C6	T16PR-U15	ITF16TT
ARF46	T20R-U	-
ARF52	T16PR-U	ITF16TT
ARF526	T16PR-U15	ITF16TT
ARF528	T16PR-U15	ITF16TT
ARF6	T16R-U	IT16TT
ARF62	T14PR-U	ITF16TT

MOTORCRAFT	DENSO	TT
ARF626	T14PR-U	ITF16TT
ARF8	T16R-U	IT16TT
ARF86	T16R-U	IT16TT
ARL5	W16LS	-
ARL8	W14L	-
ARL82	W14L	-
AS42C	W20PR-U	-
AS4C	W20SR-U	-
AS52C	W16PR-U	-
AS827	W14PR-U	-
ASF32	T20PR-U	ITF20TT
ASF32C	T20PR-U	ITF20TT
ASF32C6	T20PR-U15	ITF20TT
ASF32CM	T20PR-U	ITF20TT
ASF32M	T20PR-U	ITF20TT
ASF32P	T20PR-U11	ITF20TT
ASF3C	T20PR-U	ITF20TT
ASF3C6	T20PR-U15	ITF20TT
ASF42	T16PR-U	ITF16TT
ASF42C	T16PR-U	ITF16TT
ASF42C6	T16PR-U15	ITF16TT
ASF42C7	T16PR-U	ITF16TT
ASF42P	T16PR-U	ITF16TT
ASF44P	T16PR-U11	ITF16TT
ASF4C	T16PR-U	ITF16TT
ASF4C6	T16PR-U15	ITF16TT
ASF52	T16PR-U	ITF16TT
ASF526	T16PR-U15	ITF16TT
ASF52C	T16PR-U	ITF16TT
ASF52C7	T16PR-U15	ITF16TT
ASF8	T16R-U	IT16TT
ASF86	T16R-U	IT16TT
AT1	W27S-U	-
AT10	W9-U	-
AT2	W24S-U	-
AT3	W20S-U	-
AT4	W16S-U	-
AT42	W16PR-U	-
AT6	W14PR-U	-
AT8	W14PR-U	-
ATL3	W16LS	-
ATL4	W16LS	-
ATL8	W14L	-
AV091X4	W27FSR-U10	-
AV1X	W22FS-U	-
AV23	IWF24	-
AV2X	W20FSR-U	WF20TT
AV4	W16FSR	-
AV6	W14F-U	-
AV603	IWF27	-
AV701CU10	W27FSR-U10	-
AV901X	W27FSR	-
AV901X4	W27FSR-U10	-
AV903	IWF24	-
AVKO	SF-50	-
AVKOD	SF-51	-
AVZKO	SF-50	-
AWRF32	T20EPR-U	T20TT
AWRF325	T20EPR-U15	T20TT
AWRF42	T16EPR-U	T16TT
AWS42EE	PT16EPR-L13	IT16TT
AWS44EE	PT16EPR-L13	IT16TT
AWSF22C	T20EPR-U	T20TT
AWSF22E	T20EPR-U	T20TT
AWSF22F	PT16EPR-L13	IT16TT
AWSF22FM	PT16EPR-L13	IT16TT
AWSF22FS	PT16EPR-L13	IT16TT
AWSF24	T20NR-U11	IT20TT
AWSF24C	T20NR-U11	IT20TT
AWSF32	T20EPR-U	T20TT
AWSF32C	T20EPR-U	T20TT

Spark & Glow Plugs

Cross Reference Chart - Competitor

MOTORCRAFT	DENSO	TT
AWSF32E	PT16EPR-L13	IT16TT
AWSF32EE	PT16EPR-L13	IT16TT
AWSF32EG	PT16EPR-L13	IT16TT
AWSF32F	PT16EPR-L13	IT16TT
AWSF32FM	PT16EPR-L13	IT16TT
AWSF32P	PT16EPR-L13	IT16TT
AWSF32PF	PT16EPR-L13	IT16TT
AWSF32PM	PT16EPR-L13	IT16TT
AWSF32PP	PT16EPR-L13	IT16TT
AWSF32Z11	VT16	IT16TT
AWSF34	T20NR-U11	IT20TT
AWSF34C	T20NR-U11	IT20TT
AWSF34P	T20NR-U11	IT20TT
AWSF34PP	T20NR-U11	IT20TT
AWSF3PP	PT16EPR-L13	IT16TT
AWSF42	T16EPR-U	T16TT
AWSF42C	T16EPR-U	T16TT
AWSF42C6	T16EPR-U15	T16TT
AWSF42EE	PT16EPR-L13	IT16TT
AWSF42P	T16EPR-U	T16TT
AWSF42PP	PT16EPR-L13	IT16TT
AWSF44	T16NR-U11	IT16TT
AWSF44C	T16NR-U11	IT16TT
AWSF44EE	PT16EPR-L13	IT16TT
AWSF44PP	PT16EPR-L13	IT16TT
AWSF52	T16EPR-U	T16TT
AWSF52C	T16EPR-U	T16TT
AWSF54	T16NR-U11	IT16TT
AWSF54C	T16NR-U11	IT16TT
AWSF62	T16EPR-U	T16TT
AWSFA32C	T20EPR-U	T20TT
AYFS092FEC	ITV24	-
AYFS22C	ITV22	-
AYFS220B	T16VR-U10	TV16TT
AYFS22FE1J	ITV22	-
AYFS22FM	ITV22	-
AYFS22FPM	PT16VR13	TV16TT
AYFS22PP	ITV22	-
AYFS22PP1	PT16VR13	TV16TT
AYFS32CJ	T16VR-U10	TV16TT
AYRF22P	PT16VR13	TV16TT
AYRF22PG1	PT16VR13	TV16TT
AYRF22PP	PT16VR13	TV16TT
AZ2	W24S-U	-
AZ3	W20S-U	-
AZ7	W9-U	-
AZ9	W9-U	-
AZFS22C	T16VR-U10	TV16TT
AZFS22FE	PT16VR13	TV16TT
AZFS22PP	PT16VR13	TV16TT
AZFS32F	PT16VR13	TV16TT
AZFS32FE	PT16VR13	TV16TT
B2W	M24S	-
B3W	M22	-
B3X	M22	-
B4X	M22	-
B6W	M17	-
B82	L14-U	-
B8X	L14-U	-
BF22	MA20P-U	-
BF22C	MA20P-U	-
BF22CX	MA20P-U	-
BF22X	MA20P-U	-
BF32	MA20P-U	-
BF32C	MA20P-U	-
BF32X	MA20P-U	-
BF42	MA16PR-U	-
BF42C	MA16PR-U	-
BF82	MA16PR-U	-
BF82C	MA16PR-U	-
BF8Z	L14-U	-

MOTORCRAFT	DENSO	TT
BF92	MA9P-U	-
BR8	L14-U	-
BRF22	MA20PR-U	-
BRF22C	MA20PR-U	-
BRF22CX	MA20PR-U	-
BRF22X	MA20PR-U	-
BRF31	MA20PR-U	-
BRF314	MA20PR-U	-
BRF32	MA20PR-U	-
BRF32C	MA20PR-U	-
BRF32C1	MA20PR-U	-
BRF32X	MA20PR-U	-
BRF3M	MA20PR-U	-
BRF42	MA16PR-U	-
BRF6	MA16PR-U	-
BRF82	MA16PR-U	-
BSF3	MA20PR-U	-
BSF31	MA20PR-U	-
BSF314	MA20PR-U	-
BSF42	MA16PR-U	-
BSF42C	MA16PR-U	-
BSF44C	MA20PR-U	-
BSF44P	MA20PR-U	-
BSF6	MA16PR-U	-
BSF82	MA16PR-U	-
BSF82C	MA16PR-U	-
BSF92	MA9P-U	-
BT10	L14-U	-
BT15	L14-U	-
BT2	M24S	-
BT3	M22	-
BT4	M22	-
BT6	M17	-
BT8	L14-U	-
BT9	L14-U	-
BTF3	MA20PR-U	-
BTF31	MA20PR-U	-
BTF42	MA16PR-U	-
BTF6	MA16PR-U	-
BTRF42	MA16PR-U	-
BTS8	L14-U	-
BZ8	L14-U	-
CYFS12F3	ITV22	-
CYFS12YECB	ITV22	-
CYFS12YP	ITV22	-
CYFS12YPC	ITV22	-
CYFS12YPC5	ITV22	-
EZD.10	DG-012	-
EZD.11	DG-001	-
EZD.12	DG-001	-
EZD.13	DG-202	-
EZD.14	DG-001	-
EZD.15	DG-001	-
EZD.16	DG-001	-
EZD.18	DG-198	-
EZD.2	DG-001	-
EZD.22	DG-114	-
EZD.23	DG-143	-
EZD.4	DG-001	-
EZD.5	DG-001	-
EZD.6	DG-123	-
EZD.7	DG-114	-
EZD.8	DG-004	-
EZD.A	DG-012	-
EZD.B	DG-001	-
EZD.C	DG-001	-
EZD.D	DG-202	-
EZD.E	DG-001	-
EZD.F	DG-001	-
EZD.G	DG-001	-
EZD.U	DG-198	-

MOTORCRAFT	DENSO	TT
EZD.Y	DG-114	-
EZD.Z	DG-143	-
EZD10	DG-012	-
EZD11	DG-001	-
EZD12	DG-001	-
EZD13	DG-202	-
EZD14	DG-001	-
EZD15	DG-001	-
EZD16	DG-001	-
EZD18	DG-198	-
EZD2	DG-001	-
EZD22	DG-114	-
EZD23	DG-143	-
EZD4	DG-001	-
EZD5	DG-001	-
EZD6	DG-123	-
EZD7	DG-114	-
EZD8	DG-004	-
EZDA	DG-012	-
EZDB	DG-001	-
EZDC	DG-001	-
EZDD	DG-202	-
EZDE	DG-001	-
EZDF	DG-001	-
EZDG	DG-001	-
EZDU	DG-198	-
EZDY	DG-114	-
EZDZ	DG-143	-
HG2	X24ESR-U	-
HG22	X24EPR-U9	-
HG22C	X24EPR-U9	-
HG2C	X24ESR-U	-
HGS22C	X24EPR-U9	-
HV2	X24FS-U	-
HV22	X20FSR-U	-
HV2C	X24FS-U	-
HV3	X20FSR-U	-
PV1	U24FSR-U	-
PV2	U22FSR-U	-
PV3	U20FSR-U	-
SP412	T20EPR-U15	T20TT

NGK	DENSO	TT
0005	T16VR-U10	TV16TT
0127	VK20	IK20TT
1005	VKH20	IKH20TT
1009	DG-003	-
1010	M17	-
1011	IW22	-
1013	VKA20	-
1015	W24ESR-U	-
1019	DG-005	-
1024	MA20PR-U	-
1028	W14EX-U	IW16TT
1029	W20MPR-U10	-
1030	IX24B	-
1032	DG-157	-
1034	W22EPR-U	W22TT
1041	QJ20CR11	Q20TT
1043	IW24	-
1046	W20FR-L	WF20TT
1047	W24FPR	-
1048	T20EPR-U15	T20TT
1049	IT24	-
1052	W20FSR-U	WF20TT
1059	IXU01-31	-
1063	IW01-32	-
1065	DG-157	-
1068	X20EPR-U9	-
1071	MA20PR-U	-
1072	IXU01-34	-

NGK	DENSO	TT
1081	VQ20	IQ20TT
1084	PQ20R	Q20TT
1085	IT27	-
1086	Q14R-U11	IQ16TT
1087	W22EPR-U	W22TT
1088	Q16R-U11	Q16TT
1089	Q22PR-U11	-
1090	W20FSR-U	WF20TT
1092	W22FPR-U	-
1093	W22FPR-U	-
1094	T22EP-U	-
1095	Q22PR-U11	-
1096	W14EXR-U11	IW16TT
1097	W14E	-
1098	W22FSR	-
1099	Q16PR-U11	Q16TT
1101	DG-113	-
1108	VKH16	IKH16TT
1110	M22	-
1111	W22ES-U	-
1117	X24ESR-U	-
1124	MA16PR-U	-
1125	IW22	-
1127	T14PR-U	ITF16TT
1128	W20ETR-L	IW20TT
1134	W24FSR-U10	-
1142	W22EPR-U	W22TT
1143	W14EXR-U11	IW16TT
1144	W22EPR-U	W22TT
1145	Q16PR-U	Q16TT
1146	Q20R-U	Q20TT
1147	W9LM-US	-
1148	Q16R-U11	Q16TT
1149	W22EPR-U11	W22TT
1152	IQ27	-
1155	IW01-32	-
1157	W24FSR-U10	-
1175	VK22G	-
1179	IXU22	-
1180	W16EPR-U11	W16TT
1183	T20EPR-U	T20TT
1188	IK16	IK16TT
1199	S-31A	-
1208	VKH20	IKH20TT
1210	M24S	-
1212	W20EPR-U11	W20TT
1219	VK16	IK16TT
1228	W14LM-U	-
1229	DG-114	-
1230	IX27B	-
1239	DG-012	-
1243	PQ16R	Q16TT
1249	DG-157	-
1250	DG-001	-
1257	PQ20R	Q20TT
1262	IW24	-
1263	W20EPB	W20TT
1265	IW27	-
1266	Q16R-U	Q16TT
1267	Q22PR-U11	-
1268	T22MP-U	-
1269	Q20PR-U	Q20TT
1270	T20MP-U	-
1271	Q22PR-U11	-
1272	Q22PR-U	-
1273	Q16PR-U11	Q16TT
1275	U24ESR-N	-
1277	ITF20	ITF20TT
1281	PK20PR11	K20TT
1283	K22PR-U11	-
1284	IAE01-34	-

NGK	DENSO	TT
1295	W14E	-
1297	Q20PR-U	Q20TT
1299	X31ETR	-
1305	FXE24HR11	-
1311	VFK16	IK16TT
1312	VFK20F	IK20TT
1313	K16PSR-B8	IK16TT
1314	SK20PR-L11	IK20TT
1317	VFXEH22	IXEH22TT
1436	DG-112	-
1441	DG-116	-
1462	U22ETR	-
1464	SXU22PR9	-
1496	VK20T	IK20TT
1497	VW20T	IW20TT
1498	VQ20	IQ20TT
1501	FK20HBR11	IKH20TT
1511	ITV16	ITV16TT
1516	VT20	IT20TT
1534	VFK16	IK16TT
1565	VK20	IK20TT
1566	DG-146	-
1567	K20TT	K20TT
1567	K20TXR	K20TT
1578	XU22HDR9	XUH22TT
1582	U20EPR9	-
1632	PK20PR-L11	IK20TT
1637	VKH16	IKH16TT
1640	VKH20	IKH20TT
1643	XU22HDR9	XUH22TT
1654	VFXEH22	IXEH22TT
1662	K16PR-U11	K16TT
1663	DG-300	-
1664	PKJ16CR-L11	IK16TT
1667	K16PR-U	K16TT
1669	K16HR-U11	KH16TT
1673	Y27FER-C	-
1675	PK22PR8	-
1684	DG-113	-
1691	XU22EPR-U	XU22TT
1748	IK20L	IK20TT
1749	DG-110	-
1959	IKH20	IKH20TT
1961	VXUHC22G	-
1983	DG-302	-
1989	SXU22HDR8	-
2000	IA01-31	-
2001	IA01-34	-
2002	IAE01-32	-
2003	IAE01-34	-
2004	IAE01-32	-
2015	W9EXR-U+CU	-
2023	W22EPR-U	W22TT
2024	MA16PR-U	-
2027	W20MR-U	-
2033	W22EBR	-
2042	T20EPR-U	T20TT
2046	IW01-24	-
2055	IW34	-
2056	Q22PR-U	-
2058	P20PR11	W20TT
2059	Q22PR-U11	-
2065	W14EXR-U11	IW16TT
2072	P20PR11	W20TT
2074	QJ16AR-U	-
2075	K20PBR	K20TT
2077	IW01-32	-
2078	K22PB	-
2086	U24FSR-U	-
2087	K16R-U	K16TT
2090	IK22	-

NGK	DENSO	TT
2091	PK16PR-L11	IK16TT
2093	PK20PR-P8	IK20TT
2095	IK22	-
2096	T16PR-U15	ITF16TT
2097	PQ16R	Q16TT
2108	W27ESR-U	-
2110	MA16PR-U	-
2113	PK16PR-P11	K16TT
2114	IWM01-34	-
2115	IW16	IW16TT
2120	X24ESR-U	-
2128	W14EXR-U	IW16TT
2129	W22FS-U	-
2130	IX22B	-
2139	T20PR-U	ITF20TT
2140	W16EPR-U	W16TT
2141	Q22PR-U11	-
2142	U27FER9	-
2144	T20M-U	-
2145	IW29	-
2147	SF-50	-
2150	IW01-24	-
2152	IXU01-27	-
2153	IW01-27	-
2158	IW27	-
2159	IQ24	-
2161	DG-162	-
2162	DG-239	-
2164	K22PBR-S	-
2168	U24FSR-U	-
2170	X27ETR	-
2171	IW01-32	-
2173	SF-51	-
2176	IW27	-
2177	IW22	-
2179	IW24	-
2184	IW31	-
2185	IQ27	-
2187	DG-215	-
2188	DG-222	-
2189	DG-198	-
2190	DG-233	-
2191	IW01-34	-
2193	U22FER9	-
2194	IX22B	-
2197	K20PBR	K20TT
2199	W31ESR-U	-
2202	IX24B	-
2204	X27ESR-U	-
2210	MA20PR-U	-
2212	W20EXR-U11	W20TT
2213	K20TNR-S	K20TT
2215	PK20R8	IK20TT
2223	T16EPR-U	T16TT
2224	T16R-U	IT16TT
2230	T14PR-U	ITF16TT
2237	DG-001	-
2238	T20EPR-U	T20TT
2242	IX27	-
2247	X31ETR	-
2248	T20PR-U15	ITF20TT
2249	K20R-U	K20TT
2251	IQ20	IQ20TT
2254	IWF27	-
2256	XU20EPR-U	-
2262	KJ16CR-U11	K16TT
2264	W9EXR-U+CU	-
2265	IXU24	-
2268	W20EPR-U	W20TT
2270	K22PR-U	-
2271	PK16R11	K16TT

NGK	DENSO	TT
2273	DG-101	-
2284	K20TNR	K20TT
2285	W16EPR-U	W16TT
2287	W16EPB10	W16TT
2288	K20TXR	K20TT
2298	W16PR-U	-
2300	PK16PR-L11	IK16TT
2302	FXE20HE11	IXEH20ETT
2305	IU27A	-
2306	U24EPR9	-
2308	U27ESR-N	-
2309	IKH22	-
2311	W22ESR-U	-
2314	ITL20	-
2316	IXU27	-
2319	W20S-U	-
2321	T20NR-U11	IT20TT
2325	IUF22	-
2327	T20EPR-U15	T20TT
2330	Q20PR-U	Q20TT
2340	PK22PR8	-
2341	PK20PR-L13	IK20TT
2347	VW20T	IW20TT
2351	Q14R-U11	IQ16TT
2353	PK20R11	K20TT
2355	K16R-U11	K16TT
2357	W22EPR-U	W22TT
2359	T16EPR-U15	T16TT
2360	U31ETR	-
2364	W16EPR-U	W16TT
2365	PQ16R	Q16TT
2372	IQ16	IQ16TT
2374	ITF24	-
2378	Q14R-U11	IQ16TT
2380	PK22PR-L11S	-
2382	K16PR-U11	K16TT
2385	IQ16	IQ16TT
2386	IXU22	-
2387	K22PR-U11	-
2391	K16PR-L11	K16TT
2392	PK16R8	IK16TT
2396	IW01-32	-
2397	K20PBR-S10	K20TT
2399	W31FS	-
2400	P22PR8	-
2401	IW27	-
2402	T20EPR-U15	T20TT
2405	ITF20	ITF20TT
2408	DG-005	-
2409	U14FSR-UB	-
2411	W24ESR-U	-
2412	W22EPR-U	W22TT
2417	W20FSR-U	WF20TT
2419	DG-008	-
2420	X27ESR-U	-
2421	W22FS-U	-
2422	SF-50	-
2423	T16PR-U	ITF16TT
2434	IWM27	-
2438	MA20PR-U	-
2440	Q14R-U11	IQ16TT
2443	J16CR-U	W16TT
2445	PQ16R	Q16TT
2446	VQ20	IQ20TT
2449	PK20PR-L13	IK20TT
2451	T16PR-U15	ITF16TT
2457	IWM31	-
2460	K16PR-U	K16TT
2466	IT20	IT20TT
2467	PT16VR13	TV16TT
2470	W20EPBR-S	W20TT

NGK	DENSO	TT
2477	IK16L	IK16TT
2484	IW01-32	-
2485	PK20PR-P11	K20TT
2495	IU01-27	-
2500	DG-197	-
2501	VK16	IK16TT
2513	PK20TR11	K20TT
2522	SF-50	-
2526	K16R-U11	K16TT
2527	T14PR-U	ITF16TT
2528	W22ESR-U	-
2531	DG-157	-
2546	IK16	IK16TT
2547	T20EPR-U	T20TT
2550	PK20R13	K20TT
2551	IK22	-
2556	X24ESR-U	-
2563	IK20	IK20TT
2574	WK20	IK20TT
2591	IAE01-32	-
2610	MA16PR-U	-
2611	W27ESR-U	-
2621	W24FSR	-
2622	SF-50	-
2623	T20PR-U	ITF20TT
2630	W24FP-U	-
2633	W20FPR-U10	WF20TT
2634	IWF24	-
2635	W14EXR-U	IW16TT
2637	W16PR-U	-
2641	XU27EPR-U	-
2642	W14EXR-U11	IW16TT
2643	DG-001	-
2645	PK20PR-P8	IK20TT
2647	PK16PR-L11	IK16TT
2659	IW31	-
2660	IK24	-
2667	IK22	-
2668	IK24	-
2669	IK27	-
2671	IW24	-
2672	IUF24	-
2680	W20M-US	-
2683	T16EPR-U15	T16TT
2684	PK20PR11	K20TT
2686	DG-172	-
2687	K20PSR-B8	IK20TT
2689	W27ESR-V	-
2690	VK22	-
2691	DG-145	-
2696	DG-307	-
2697	IWM01-32	-
2702	IQ01-24	-
2707	IWM27	-
2710	MA20P-U	-
2712	W22EPR-U11	W22TT
2720	X31ESR-U	-
2721	IWF27	-
2727	T14PR-U	ITF16TT
2734	IX22	-
2737	QJ20CR11	Q20TT
2738	IW16	IW16TT
2740	IWF22	-
2741	IW01-32	-
2743	PK20PR-P11	K20TT
2746	W20PR-U	-
2751	W14FR-L	-
2756	K20PR-U11	K20TT
2761	PK16PR-L11	IK16TT
2771	T20PR-U	ITF20TT
2772	K20TXR	K20TT

NGK	DENSO	TT
2773	IW01-34	-
2776	VK22	-
2777	IW22	-
2781	IK24	-
2782	IK24	-
2785	DG-010	-
2788	IAE01-32	-
2789	K16TNR-S9	K16TT
2790	IA01-34	-
2792	W22FS-U	-
2809	IRT01-31	-
2813	IW01-32	-
2817	ITF22	-
2821	W24ESR-U	-
2822	W14EXR-U11	IW16TT
2825	IX22	-
2828	W16EXR-U	W16TT
2830	T20EPR-U15	T20TT
2834	IX27	-
2838	PK16R11	K16TT
2840	PK20PR-P8	IK20TT
2841	ITF16	ITF16TT
2842	IX22B	-
2846	IK01-27	-
2848	K20TNR	K20TT
2850	IX24	-
2851	W16EXR-U	W16TT
2862	Y31FER-C	-
2867	PK16R11	K16TT
2871	X27ESR-U	-
2872	IX24B	-
2874	U16FSR-U	-
2876	W20EPBR-S	W20TT
2877	W22ESR-U	-
2880	IW01-24	-
2881	IRE01-27	-
2885	IT20	IT20TT
2887	X16EPR-U9	-
2890	K20TXR	K20TT
2891	W22S-U	-
2895	IK22	-
2900	VKH22	-
2910	MW17	-
2911	W14PR-U	-
2912	W24EPR-U	-
2922	MA20PR-U	-
2923	X24ESR-U	-
2924	T16PR-U11	ITF16TT
2927	T20R-U	-
2933	IX24B	-
2938	IWF22	-
2940	W31FS	-
2941	J16CR-U	W16TT
2948	W20EPR-U	W20TT
2950	PQ16R8	Q16TT
2951	DG-221	-
2952	IQ01-27	-
2954	IW01-27	-
2963	W20MP-U	-
2975	KJ22CR-L11	-
2978	PK20R11	K20TT
2979	DG-245	-
2983	U20FSR-U	-
2984	IQ24	-
2985	IQ16	IQ16TT
2989	MA20P-U	-
2990	W16PR-U	-
3000	PK16PR-L11	IK16TT
3001	IW01-24	-
3006	IWM31	-
3010	M22	-

NGK	DENSO	TT
3011	W16PR-U	-
3014	W24FSR	-
3017	DG-304	-
3025	IX24	-
3028	W16EXR-U11	W16TT
3030	DG-235	-
3035	W24EMR-C	-
3040	DG-187	-
3044	IK27	-
3045	K20PBR-S10	K20TT
3061	IU24	-
3064	IK20L	IK20TT
3078	DG-155	-
3089	IW27	-
3099	VK20Y	-
3100	PK20PR-P8	IK20TT
3106	S22PR-A7	-
3107	SK16PR-L11	IK16TT
3108	IX22B	-
3110	W9-U	-
3111	W20PR-U	-
3112	W14L	-
3116	VKB20	-
3122	MA16PR-U	-
3123	X22ESR-U	-
3124	T16PR-U15	ITF16TT
3129	IRE01-27	-
3130	W24ESR-V	-
3132	Q20PR-U11	Q20TT
3133	W24FPR-U10	-
3136	J16CR-U	W16TT
3141	PK20PR-L13	IK20TT
3146	X22EPR-U9	-
3153	W16EXR-U	W16TT
3154	W16EXR-U13	W16TT
3161	IU24	-
3165	IU01-34	-
3169	IK24	-
3172	W20EPBR-S	W20TT
3173	IW16	IW16TT
3174	IU01-27	-
3177	T20EPR-U	T20TT
3179	IK01-31	-
3180	W24FPR-U10	-
3181	X16EPR-U9	-
3187	IW22	-
3188	X27ETR	-
3194	W27ESR-U	-
3197	IUF27A	-
3199	K20TXR	K20TT
3200	P22PR8	-
3201	W22MPR-U	-
3210	W14PR-U	-
3212	W16LS	-
3215	PQ16R	Q16TT
3219	DG-001	-
3221	IRE01-27	-
3228	U20FSR-U	-
3230	W27ESR-V	-
3232	W16EKR-S11	W16TT
3236	IW24	-
3239	W16EPR-U	W16TT
3240	PK20R11	K20TT
3245	IW27	-
3249	ITF24	-
3252	W27EMR-C	-
3253	IQ01-31	-
3256	IU27A	-
3261	IW01-32	-
3268	PK16R11	K16TT
3271	PKJ20CR-L11	IK20TT

NGK	DENSO	TT
3272	IA01-32	-
3275	IK31	-
3280	IU01-31	-
3306	IQ16	IQ16TT
3311	W14FPR-U	-
3312	W20ESR-U	-
3319	DG-126	-
3321	W22EBR	-
3322	W14FR-U	-
3323	MA20PR-U	-
3324	T20PR-U15	ITF20TT
3326	X16FSR-U	-
3330	Q22PR-U	-
3331	IX27B	-
3332	W20PR-U	-
3334	IWM01-32	-
3335	IW24	-
3336	IQ22	-
3340	IXU01-27	-
3342	IRE01-31	-
3344	IT22	-
3346	T22EP-U	-
3349	T16EPR-U15	T16TT
3350	PQ20R	Q20TT
3354	W24S-U	-
3355	W22EPR-U	W22TT
3356	VK20T	IK20TT
3360	IUH27	-
3366	RU01-27	-
3376	ITF20	ITF20TT
3377	W20EPBR-S	W20TT
3382	IK34	-
3384	K20TXR	K20TT
3388	IU01-27	-
3395	IK31	-
3406	IK22	-
3410	W14LM-U	-
3412	T16PR-U	ITF16TT
3413	DG-122	-
3419	IWF22	-
3430	W24ES-V	-
3436	IW16	IW16TT
3437	X27ESR-U	-
3440	PK16R11	K16TT
3442	ITF27	-
3452	PK20TR11	K20TT
3456	IA01-31	-
3466	P16R13	W20TT
3467	W9EP	-
3468	W16EXR-U	W16TT
3470	PK16R11	K16TT
3472	IXU01-31	-
3473	DG-001	-
3475	T20R-U	-
3478	U24ETR	-
3479	PK20PR-P8	IK20TT
3481	XU20EPR-U	-
3483	X24EPR-U9	-
3486	IJ22FER9	-
3488	T20EPR-U	T20TT
3500	PK20PR-P8	IK20TT
3506	IW31	-
3508	SK16R-P8	IK16TT
3510	W20S-U	-
3511	W14FPR-UL	-
3512	T20PR-U	ITF20TT
3520	IWM24	-
3521	IU27	-
3522	W20SR-U	-
3524	Q16PR-U11	Q16TT
3525	IW31	-

NGK	DENSO	TT
3526	T22EP-U	-
3527	W22ESR-U	-
3529	W16EKR-S11	W16TT
3530	W27ES-V	-
3535	ITF22	-
3536	K20P-U	K20TT
3539	IK20	IK20TT
3540	IK20	IK20TT
3544	IK22	-
3546	PK20PR-L11	IK20TT
3549	IAE01-34	-
3557	ITF27	-
3559	IRE01-27	-
3566	VK16	IK16TT
3568	W14MR-U	-
3570	W27ESR-V	-
3571	IQ27	-
3573	P16PR11	W16TT
3577	W20EXR-U11	W20TT
3579	W22FSR	-
3583	K20TR11	K20TT
3584	K20TXR	K20TT
3586	PKJ20CR-L11	IK20TT
3587	ITV20	ITV20TT
3588	VKH20	IKH20TT
3605	IXU22	-
3606	IXU24	-
3611	W14FPR-UL	-
3612	ITF22	-
3617	DG-004	-
3618	IWM01-34	-
3623	T20EPR-U	T20TT
3624	T20R-U	-
3625	IW24	-
3626	W27FSR-U10	-
3628	W16ETR-S	W16TT
3630	IW31	-
3635	IT22	-
3639	W24ESR-U	-
3641	VXU22	-
3645	DG-001	-
3650	IK24	-
3653	VUH24D	-
3654	VKA20	-
3656	IKH20	IKH20TT
3657	SKJ16DR-M11	IK16TT
3672	K20HR-U11	KH20TT
3678	PK20PRZ11	IK20TT
3679	VKJ16CR-L13	IK16TT
3680	IY24	-
3683	W24ESR-U	-
3684	W22EPB	W22TT
3686	K16PR-U11	K16TT
3687	DG-104	-
3688	PK20PR11	K20TT
3689	IT20	IT20TT
3690	IT22	-
3691	IT24	-
3696	K20R-U	K20TT
3698	IWM01-34	-
3703	DG-142	-
3704	DG-012	-
3709	DG-189	-
3710	W22S-U	-
3712	T16EPR-U	T16TT
3717	X27EPR-U9	-
3720	Q20R-U11	Q20TT
3722	W16FSR	-
3724	W16ESR-U	-
3725	W24FPR	-
3733	IQ22	-

NGK	DENSO	TT
3738	P20PR11	W20TT
3741	PKJ16CR8	-
3753	IQ20	IQ20TT
3754	T16EPR-U	T16TT
3764	IK20	IK20TT
3781	W16EPR-U	W16TT
3782	DG-216	-
3783	K20PR-U	K20TT
3784	PT16EPR-L13	IT16TT
3786	DG-144	-
3787	ITV22	-
3788	IW31	-
3789	ITV20	ITV20TT
3790	VKH20Y	-
3795	IRL01-27	-
3797	IUH24	-
3809	IQ01-27	-
3810	W24S-U	-
3811	ITV16	ITV16TT
3812	T20EPR-U	T20TT
3818	DG-005	-
3821	W22EBR	-
3823	W24FPR-U10	-
3824	W20ESR-U	-
3825	IW27	-
3826	W20EKR-S11	IW20TT
3829	DG-012	-
3830	IW31	-
3836	IW01-31	-
3837	PQ20R	Q20TT
3841	W9LMR-US	-
3850	W20MR-U	-
3852	DG-111	-
3854	IX27B	-
3856	ITF27	-
3857	IRE01-32	-
3861	DG-306	-
3869	KJ20CR-L11	K20TT
3872	IUH27	-
3873	DG-004	-
3874	IW29	-
3901	U22EPR9	-
3903	IW20	IW20TT
3905	IU01-31	-
3909	IW01-32	-
3913	W27S-U	-
3914	IWF27	-
3922	W20FSR-U	WF20TT
3923	W24EPR-U	-
3927	IW27	-
3928	W14EXR-U11	IW16TT
3930	P16R	W20TT
3932	XU22EPR-U	XU22TT
3933	PQ20R	Q20TT
3935	IW01-27	-
3943	IU24	-
3949	IW01-32	-
3951	T20EPR-U15	T20TT
3961	W24ESR	-
3964	K20TXR	K20TT
3965	DG-006	-
3967	K16TR11	K16TT
3969	ITF16	ITF16TT
3971	P16R	W20TT
3972	W24ESR-U	-
3974	IK27	-
3975	W20FPR-U	WF20TT
3978	PK22PR-L11S	-
3979	IQ02-27	-
3981	IW27	-
3987	P16PR11	W16TT

NGK	DENSO	TT
3988	W27ESR-U	-
3999	ITF20	ITF20TT
4002	W20MR-U	-
4003	W22M-U	-
4004	W14MR-U	-
4006	W16EPR-U	W16TT
4008	W20EPR-U	W20TT
4010	W14F-U	-
4011	Y24FER-C	-
4012	W16EXR-U13	W16TT
4013	W9LMR-US	-
4014	PK20PR11	K20TT
4016	IWF27	-
4024	W22ESR-U	-
4027	W24ESR-U	-
4028	W16EXR-U11	W16TT
4042	U20FSR-U	-
4043	KJ14CR11	-
4045	PQ20R	Q20TT
4046	Q20PR-U	Q20TT
4055	IW22	-
4073	K20R-U11	K20TT
4074	IW01-27	-
4075	IQ02-24	-
4076	IW01-32	-
4079	T20PR-U	ITF20TT
4080	VKB16	-
4085	IWF20	-
4090	DG-130	-
4091	IK22	-
4095	VKJ20RZ-M11	-
4110	W14F-U	-
4111	W16FPR-U	-
4114	W20MPR-U10	-
4115	PK20PR-L13	IK20TT
4118	DG-007	-
4119	DG-115	-
4120	Q16R-U11	Q16TT
4121	W22EBR	-
4122	W22FSR	-
4123	T16R-U	IT16TT
4128	W20EXR-U11	W20TT
4129	W14E	-
4133	W14LM-U	-
4140	ITF24	-
4144	IK31	-
4150	IU01-31	-
4156	IUF27A	-
4174	PQ20R	Q20TT
4175	IT24	-
4177	T20EPR-U	T20TT
4179	XU24EPR-U	-
4180	PK22PR8	-
4182	DG-012	-
4187	DG-144	-
4193	IAE01-32	-
4200	W20FSR-U	WF20TT
4210	W16FSR	-
4215	DG-012	-
4216	RU01-31	-
4218	IU24	-
4221	W27EBR	-
4224	W14EXR-U11	IW16TT
4226	W22M-U	-
4228	W20EXR-U11	W20TT
4233	IW20	IW20TT
4234	IWM31	-
4249	W16EXR-U13	W16TT
4254	IU01-31	-
4259	IU22	-
4266	IK02-27	-

NGK	DENSO	TT
4268	W14EXR-U11	IW16TT
4275	DG-119	-
4279	DG-003	-
4282	IRL01-31	-
4285	IK22	-
4286	IU24	-
4288	SXU22HDR8	-
4290	DG-004	-
4291	KJ20CR-U11	K20TT
4292	PK16PR-L11	IK16TT
4293	K20PR-U11	K20TT
4294	VK20	IK20TT
4296	W20FR-L	WF20TT
4297	X27ETR	-
4300	IKH16	IKH16TT
4302	PK16TR11	K16TT
4305	DG-300	-
4309	DG-182	-
4311	IRE01-34	-
4315	DG-300	-
4321	IRE01-27	-
4322	W24FSR	-
4323	T20R-U	-
4337	IW27	-
4341	PK16PR-L11	IK16TT
4342	VKH20	IKH20TT
4344	ITV16	ITV16TT
4345	W22MPR-U	-
4347	IXU24	-
4356	DG-001	-
4359	DG-116	-
4363	SKJ16CR-L11	IK16TT
4364	PK22PR8	-
4368	K20R-U11	K20TT
4370	IQ02-27	-
4371	PK22PR8	-
4374	IU24A	-
4377	PK20PR-P8	IK20TT
4379	IKH24	-
4386	T16PR-U15	ITF16TT
4388	K20TXR	K20TT
4389	DG-102	-
4392	T16EPR-U	T16TT
4409	DG-008	-
4415	XU22EPR-U	XU22TT
4421	IK16	IK16TT
4424	W16EPR-U11	W16TT
4425	IWF24	-
4429	U16FSR-U	-
4430	X24GPR-U	-
4433	PK20TR11	K20TT
4435	K16GPR-U11	-
4450	IUH24	-
4452	W9LMR-US	-
4455	IU24A	-
4457	IW01-31	-
4458	VKH20	IKH20TT
4461	W20FR-L	WF20TT
4467	DG-124	-
4469	IKH16	IKH16TT
4477	ZT20EPR11	T20TT
4479	DG-123	-
4483	K20TXR	K20TT
4485	IQ22	-
4488	ITF20	ITF20TT
4492	IW01-24	-
4495	W24FPR-U10	-
4497	VQ20	IQ20TT
4499	IKH27	-
4509	U22ESR-N	-
4510	W20FSR-U	WF20TT

NGK	DENSO	TT
4511	W20FPR-U	WF20TT
4517	IK02-31	-
4520	DG-121	-
4521	IRE01-27	-
4522	W27FSR	-
4525	IW24	-
4528	W27EBR	-
4533	IUF22	-
4536	W16PR-U	-
4546	IUH24	-
4547	IU31A	-
4548	U27ETR	-
4549	U22FSR-U	-
4551	W27FSR-U10	-
4553	W20FPR-U	WF20TT
4555	IWF20	-
4559	T16VR-U10	TV16TT
4562	W20MP-U	-
4563	K20PBR	K20TT
4577	W22S-U	-
4578	U22ESR-N	-
4579	VQ22	-
4581	ITF20	ITF20TT
4582	IRE01-27	-
4585	DG-001	-
4588	PQ16R	Q16TT
4589	SK20R11	IK20TT
4590	IQ02-31	-
4600	DG-145	-
4602	DG-202	-
4612	ITL20	-
4613	VXU22	-
4614	IA01-32	-
4615	IK27	-
4617	DG-302	-
4618	W9LMR-US	-
4619	K20PR-U	K20TT
4620	PKJ16CR-L11	IK16TT
4623	X16FSR-U	-
4624	W16EPR-U11	W16TT
4626	W22MPR-U	-
4629	U22FSR-U	-
4630	X27GPR-U	-
4632	W20FR-L	WF20TT
4635	IWF20	-
4636	K16PR-U11	K16TT
4637	IQ02-31	-
4638	IW34	-
4639	PK20PR11	K20TT
4642	PK16PR-P11	K16TT
4645	DG-004	-
4651	PK20R11	K20TT
4652	MA9P-U	-
4654	IKH27	-
4656	IKH01-27	-
4657	IKH01-31	-
4658	IK01-27	-
4660	IK27	-
4663	IU22	-
4663	U22ESR-NB	-
4664	DG-502	-
4673	VKH20	IKH20TT
4675	IU27	-
4684	W31ESR-U	-
4685	IK22	-
4691	W16EXR-U	W16TT
4694	DG-127	-
4695	U14FSR-UB	-
4696	VK16	IK16TT
4699	IK02-24	-
4704	K20HR-U11	KH20TT

NGK	DENSO	TT
4705	DG-117	-
4707	IK27C11	-
4708	IU24	-
4709	IK27C11	-
4712	U20FSR-U	-
4717	IU27	-
4722	W16ESR-U	-
4725	IW27	-
4728	IW16	IW16TT
4730	X24GPR-U	-
4735	IXU01-27	-
4737	W22FSR	-
4741	IW01-27	-
4751	DG-004	-
4754	IA01-34	-
4759	SXU22PR9	-
4762	T16PR-U	ITF16TT
4764	IRE01-27	-
4772	IX27	-
4775	IKH16	IKH16TT
4778	IUF31A	-
4783	Q16PR-U11	Q16TT
4789	IK24	-
4791	DG-004	-
4793	PK20PR-P8	IK20TT
4795	XU22EPR-U	XU22TT
4818	DG-101	-
4823	X20FSR-U	-
4824	W20EPR-U11	W20TT
4830	X27GPR-U	-
4832	W31ESR-U	-
4836	IW24	-
4838	W24FPR-U10	-
4839	W24FPR-U10	-
4840	IK02-27	-
4842	DG-155	-
4853	PK22PR8	-
4854	U24ESR-N	-
4855	X24ESR-U	-
4856	K20PR-U	K20TT
4867	VK20Y	-
4870	IK16	IK16TT
4871	T20EPR-U15	T20TT
4873	IX24B	-
4875	IW16	IW16TT
4876	K20PR-U	K20TT
4877	PK22PR8	-
4885	PK20R-P8	IK20TT
4888	VNH27Z	-
4889	IK24	-
4891	IK31	-
4892	IK01-24	-
4894	IK01-31	-
4895	IQ24	-
4896	IQ27	-
4897	IQ31	-
4898	IQ01-24	-
4899	IQ01-27	-
4900	IQ01-31	-
4901	IKH24	-
4902	DG-008	-
4904	SK20HR11	IKH20TT
4905	IKH01-24	-
4912	SC20HR11	IXEH22TT
4915	W24FSR	-
4916	DG-009	-
4919	IQ20	IQ20TT
4921	W22MPR-U	-
4922	W20ESR-U	-
4929	X24EPR-U9	-
4930	Q20R-U	Q20TT

NGK	DENSO	TT
4936	K16GPR-U11	-
4937	DG-198	-
4940	IU01-31	-
4948	IU24	-
4951	DG-127	-
4956	DG-012	-
4965	SK22PR-M11	-
4966	DG-614	-
4968	IT20	IT20TT
4973	ITF20	ITF20TT
4975	Q16PR-U11	Q16TT
4983	XU22EPR-U	XU22TT
4984	P20PR11	W20TT
4985	IA01-32	-
4988	IQ31	-
4989	W27ESR-U	-
4994	DG-301	-
4996	SK16R11	IK16TT
4998	ITL16	ITL16TT
4999	IQ02-27	-
5000	DG-118	-
5005	DG-003	-
5006	U27ESR-N	-
5009	IRT01-31	-
5011	W14FPR-UL10	-
5013	DG-173	-
5017	ITL16	ITL16TT
5024	W14FPR-UL10	-
5030	Q22PR-U	-
5039	W20EP-U	W20TT
5044	IW24	-
5045	DG-106	-
5055	PT16VR10	TV16TT
5058	IK27	-
5059	DG-129	-
5065	DG-109	-
5068	VK24PRZ11	-
5084	QJ16CR11	Q16TT
5089	P20PR11	W20TT
5096	U22ESR-N	-
5098	W14FPR-UL	-
5099	IRE01-27	-
5104	DG-101	-
5109	IK02-31	-
5110	W22FS-U	-
5111	W22FPR-U	-
5116	DG-146	-
5118	FXE20HR11	IXEH20TT
5122	W22ESR-U	-
5123	X24FS-U	-
5126	W24FSR-U10	-
5127	IW31	-
5129	X22EPR-U9	-
5135	K20PBR	K20TT
5136	IW20	IW20TT
5139	IX24	-
5146	PT16EPR-L13	IT16TT
5148	DG-007	-
5149	IXUH22	-
5152	IU01-34	-
5153	IW01-27	-
5155	K16PR-U	K16TT
5156	W16EPB10	W16TT
5165	KJ16CR11	K16TT
5167	IQ02-31	-
5170	W24EPR-U	-
5171	DG-009	-
5175	VXU22	-
5182	IK16	IK16TT
5186	IQ24	-
5188	K16PR-U11	K16TT

NGK	DENSO	TT
5196	IW01-27	-
5200	PKJ20CR8	-
5201	K22TNR-S	-
5207	DG-180	-
5216	K16TNR-S9	K16TT
5219	U24FER9	-
5221	W16EPR-U11	W16TT
5224	IW01-31	-
5238	IK27	-
5245	VKH22	-
5255	IRE01-27	-
5256	W20MPR-U10	-
5264	DG-104	-
5265	IK27	-
5266	SKJ20DR-M11S	-
5267	DG-001	-
5273	IT20	IT20TT
5275	PQ20R-P8	IQ20TT
5281	IXU01-31	-
5282	Q20PR-U11	Q20TT
5285	DG-171	-
5287	DG-301	-
5312	IQ22	-
5317	DG-006	-
5318	IXUH22	-
5321	W20EPR-U11	W20TT
5327	IW22	-
5328	W20EKR-S11	IW20TT
5329	X27EPR-U9	-
5334	T20R-U	-
5339	W20EPR-U11	W20TT
5341	PK16R8	IK16TT
5343	W20FPR-U	WF20TT
5344	SK20PR-L9	IK20TT
5360	IQ01-24	-
5368	SK20PR-A11	IK20TT
5372	P22PR8	-
5373	T16EPR-U	T16TT
5375	K20PR-U	K20TT
5376	DG-211	-
5377	PK16PR-L11	IK16TT
5389	IW01-31	-
5390	DG-161	-
5411	W9EXR-U+CU	-
5413	DG-006	-
5422	W24ESR-U	-
5423	X27ESR-U	-
5424	IK16	IK16TT
5428	W20EPR-S11	W20TT
5430	IQ24	-
5441	IQ24	-
5442	IW01-24	-
5444	ITL16	ITL16TT
5452	W24ESR-U	-
5454	U27FER9	-
5459	PK16PR11	K16TT
5461	K20PBR-S10	K20TT
5463	PK16PR11	K16TT
5464	IK16	IK16TT
5467	DG-245	-
5468	VKH20	IKH20TT
5469	X22ESR-U	-
5470	IW16	IW16TT
5472	VKH20Y	-
5476	ITV16	ITV16TT
5477	IXU24	-
5483	IRE01-27	-
5487	IQ27	-
5492	IXU27	-
5495	IRT01-34	-
5497	IU01-24	-

NGK	DENSO	TT
5501	IRE01-31	-
5508	IW16	IW16TT
5510	W24FSR	-
5513	DG-240	-
5516	IQ27	-
5521	W20ETR-L	IW20TT
5531	X20EPR-U9	-
5539	W24FR-L	-
5540	DG-122	-
5541	W22FPR-U	-
5542	PK20PR-L11	IK20TT
5545	IX27B	-
5547	VKB20	-
5548	VKA16	-
5553	K20PR-U11	K20TT
5554	IK27	-
5555	PK20PR-L11	IK20TT
5558	IQ31	-
5564	W16EXR-U13	W16TT
5565	IW22	-
5566	IU01-34	-
5568	DG-119	-
5573	IW24	-
5576	IW27	-
5583	IW01-27	-
5584	KJ16CR-L11	K16TT
5585	KJ20CR-L11	K20TT
5586	KJ22CR-L11	-
5587	W22ESR-U	-
5588	VKH20	IKH20TT
5592	VK22	-
5598	ZT20EPR11	T20TT
5599	VT16	IT16TT
5600	U27ETR	-
5602	IU01-34	-
5605	DG-005	-
5606	Y24FER-C	-
5611	W14EXR-U11	IW16TT
5613	IKH16	IKH16TT
5618	DG-184	-
5621	IW20	IW20TT
5623	W14EXR-U	IW16TT
5624	IWF22	-
5626	SF-51	-
5627	IW24	-
5629	X22EPR-U9	-
5631	IX27B	-
5637	W20EP-U	W20TT
5638	W16EPR-U11	W16TT
5639	W20FSR-U	WF20TT
5642	DG-104	-
5643	K16PR-U11	K16TT
5647	IQ31	-
5648	VK20Y	-
5649	K20TXR	K20TT
5661	DG-190	-
5664	IQ16	IQ16TT
5665	DG-240	-
5666	U24FER9	-
5667	PK22PR11	-
5673	IW24	-
5675	K16PR-U	K16TT
5685	W16ETR-S	W16TT
5687	IWF27	-
5688	IQ16	IQ16TT
5689	IQ20	IQ20TT
5690	IQ22	-
5691	IQ22	-
5692	XU24EPR-U	-
5700	DG-102	-
5703	VKA20	-

NGK	DENSO	TT
5705	VKB20	-
5718	DG-003	-
5722	W27ESR-U	-
5724	K20PR-L11	K20TT
5728	W14MR-U	-
5730	W20EKR-S11	IW20TT
5738	IQ24	-
5740	DG-106	-
5742	K20PBR-S10	K20TT
5743	VW20	IW20TT
5744	IRL01-27	-
5751	W27EBR	-
5756	IXU27	-
5757	PK20PR-L11	IK20TT
5758	PKJ20CR8	-
5759	IK22	-
5760	P16PR11	W16TT
5766	VUH27ES	-
5768	VK22	-
5772	IK22	-
5773	PK20PR-P8	IK20TT
5776	K16R-U11	K16TT
5784	W20EXR-U11	W20TT
5785	IW01-24	-
5787	SXU22HCR11S	-
5788	K16HR-U11	KH16TT
5789	IT16	IT16TT
5798	W9LMR-US	-
5801	IU01-34	-
5809	ZT20EPR11	T20TT
5810	W27FSR	-
5811	W14EX-U	IW16TT
5812	U20M-U	-
5813	IK02-31	-
5816	IQ34	-
5820	IK31	-
5823	W16EXR-U	W16TT
5824	IWF22	-
5827	IW27	-
5829	X24EPR-U9	-
5831	IW34	-
5832	IW20	IW20TT
5835	IAE01-32	-
5836	KJ22CR-L11	-
5837	DG-159	-
5838	PK16PR-L11	IK16TT
5839	J16CR-U	W16TT
5843	VXUH22	-
5847	XU22HDR9	XUH22TT
5849	DG-193	-
5851	IU24	-
5855	IQ22	-
5858	W16PR-U	-
5860	Q20PR-U	Q20TT
5861	RU01-27	-
5869	Y27FER-C	-
5874	PK20PR-L11	IK20TT
5879	IW01-34	-
5880	W31ESR-U	-
5881	K22TNR-S	-
5882	IU01-27	-
5885	IT20	IT20TT
5897	IU01-31	-
5901	IQ27	-
5906	DG-010	-
5909	DG-005	-
5913	KJ22CR-L8	-
5915	DG-004	-
5921	W20MR-U	-
5924	IWF24	-
5927	IW31	-

NGK	DENSO	TT
5928	W14MP-U10	-
5929	J16BR-U	-
5930	J16AR-U11	-
5932	W20EPBR-S	W20TT
5941	DG-122	-
5942	XE20HR-U9	IXEH20TT
5943	IU27	-
5944	IWF22	-
5947	IAE01-34	-
5948	ITV20	ITV20TT
5950	T20MP-U	-
5953	W20PR-U	-
5957	RU01-34	-
5958	IU20	-
5960	KJ20DR-M11	IK20TT
5961	W24S-U	-
5962	IW01-31	-
5968	DG-178	-
5974	IQ24	-
5981	W16PR-U	-
5982	IAE01-34	-
5986	DG-121	-
5987	VKH20	IKH20TT
5989	FXE20HR11	IXEH20TT
5992	VXUH22	-
5996	DG-009	-
5998	IXU01-34	-
5999	DG-124	-
6001	DG-005	-
6002	K20TXR	K20TT
6003	DG-110	-
6010	W31FS	-
6012	IX22B	-
6026	W20MPR-U10	-
6028	W14MPR-U10	-
6029	J16AR-U11	-
6042	DG-116	-
6043	VFXEH22	IXEH22TT
6044	VT16	IT16TT
6046	IXU22	-
6074	DG-193	-
6078	T20EPR-U	T20TT
6092	DG-170	-
6097	K22PR-U	-
6124	IWF27	-
6127	W22ESR-U	-
6129	Q20PR-U	Q20TT
6130	Q16PR-U	Q16TT
6140	DG-137	-
6148	VW20	IW20TT
6154	W20FSR-U	WF20TT
6158	DG-101	-
6160	DG-300	-
6176	FK20HR11	IKH20TT
6193	X27ETR	-
6195	W16ETR-S	W16TT
6199	U24FSR-U	-
6207	VKH16	IKH16TT
6208	IUF24	-
6210	W16ESR-U	-
6211	W16EXR-U	W16TT
6212	X16FSR-U	-
6214	DG-006	-
6216	IUH27	-
6217	IWF24	-
6221	T20M-U	-
6222	W16FPR-U	-
6223	W16EXR-U11	W16TT
6226	W24ESR-U	-
6228	W14MP-U10	-
6229	J16AR-U11	-

NGK	DENSO	TT
6233	K16PR-U	K16TT
6234	K16PR-U11	K16TT
6236	IK22	-
6237	Q20PR-U	Q20TT
6239	W31ESR-U	-
6240	VKH16	IKH16TT
6241	IWF22	-
6244	DG-143	-
6246	DG-116	-
6248	P20PR11	W20TT
6253	IRE01-27	-
6256	K22PR-L11	-
6262	Q20R-U11	Q20TT
6263	U27ESR-N	-
6264	U31ESR-N	-
6265	IWF24	-
6267	IQ31	-
6281	DG-003	-
6283	VFXEH22	IXEH22TT
6285	DG-012	-
6286	DG-194	-
6287	DG-194	-
6289	IU27D	-
6290	PQ20R	Q20TT
6298	DG-142	-
6305	DG-001	-
6313	K22PR-U11	-
6314	PK20PR-P8	IK20TT
6321	W22M-U	-
6323	IQ20	IQ20TT
6324	IW16	IW16TT
6326	W20FPR-U10	WF20TT
6328	W14MPR-U10	-
6334	J16CR-U	W16TT
6338	Q22PR-U	-
6341	IK16	IK16TT
6342	K16TNR-S9	K16TT
6343	K20TXR	K20TT
6344	PT16EPR-L13	IT16TT
6345	Q16PR-U	Q16TT
6346	DG-117	-
6351	IW27	-
6354	IX24	-
6361	IX27	-
6368	IK16	IK16TT
6371	PK16PR11	K16TT
6376	K16HPR-U11	KH16TT
6378	IU24	-
6382	DG-142	-
6410	W16ESR-U	-
6411	W16EXR-U11	W16TT
6416	DG-112	-
6418	IK20	IK20TT
6419	IUH27	-
6421	T22M-U	-
6422	W22FPR-U	-
6424	IW20	IW20TT
6426	DG-227	-
6427	W20EXR-U	W20TT
6429	J16BR-U	-
6431	SF-24	-
6434	IT27	-
6436	IXU27	-
6437	K20PBR-S10	K20TT
6441	KJ20SR11	IK20TT
6448	IRE01-27	-
6449	K20PBR-S10	K20TT
6452	U16FS-UB	-
6457	RU01-34	-
6458	PK20PR-P8	IK20TT
6461	DG-117	-

NGK	DENSO	TT
6464	W20EPR-U	W20TT
6465	K20PR-U11	K20TT
6466	T20EPR-U	T20TT
6481	VKH20Y	-
6482	IU31	-
6485	PK20GR8	-
6487	IU24	-
6488	T20EPR-U	T20TT
6500	U20FSR-U	-
6502	VK16PRZ11	IK16TT
6503	VKA16	-
6504	PK22PR8	-
6506	IKH16	IKH16TT
6507	VK20Y	-
6508	IU27	-
6509	ITV20	ITV20TT
6510	ITV22	-
6511	W16EPR-U	W16TT
6512	X20FSR-U	-
6521	W22M-U	-
6523	W16ESR-U	-
6524	SK20PR-L9	IK20TT
6526	W9EXR-U+CU	-
6535	U16FSR-UB	-
6537	VKA16	-
6546	IXU24	-
6548	U31ESR-N	-
6549	IW01-24	-
6557	DG-009	-
6564	IK24	-
6573	DG-005	-
6578	W14EXR-U	IW16TT
6584	VKB16	-
6585	T16VR-U10	TV16TT
6586	DG-137	-
6587	K24PR-U11	-
6588	VK27PRZ11	-
6592	DG-174	-
6597	IW16	IW16TT
6599	DG-012	-
6600	DG-184	-
6607	IU24	-
6619	IKH20	IKH20TT
6629	X27EPR-U9	-
6630	T16PR-U	ITF16TT
6634	IWF27	-
6637	IW20	IW20TT
6639	DG-132	-
6643	FXE20HR11	IXEH20TT
6644	PT16EPR-L13	IT16TT
6645	VKH20	IKH20TT
6649	DG-118	-
6650	IXU27	-
6651	XU22PR9	XU22TT
6668	K20HR-U11	KH20TT
6669	W27ESR-V	-
6670	DG-178	-
6674	T16EPR-U15	T16TT
6677	K20HR-U11	KH20TT
6679	DG-112	-
6681	IX24	-
6684	IW24	-
6687	S22PR-A7	-
6689	U16FER9	-
6696	Q16PR-U11	Q16TT
6698	IW01-31	-
6704	DG-101	-
6707	DG-130	-
6711	KJ20DR-M11	IK20TT
6714	K16PR-U	K16TT
6715	W24FSR	-

NGK	DENSO	TT
6717	K20PR-U	K20TT
6723	W20ESR-U	-
6724	W22ESR-U	-
6726	W20MPR-U10	-
6727	W16ETR-S	W16TT
6729	W24FPR-U10	-
6741	SK20PR-A11	IK20TT
6742	IWF24	-
6748	VK20G	-
6764	IW20	IW20TT
6774	SKJ20DR-M13	IK20TT
6777	VUH27D	-
6792	DG-007	-
6799	XE20HR-U9	IXEH20TT
6801	IW31	-
6803	IK20G	-
6806	VXU22	-
6810	W16ESR-U	-
6814	IQ27	-
6821	U24FSR-U	-
6824	IW24	-
6832	IW22	-
6836	DG-605	-
6837	T20EPR-U	T20TT
6838	IK20	IK20TT
6840	IK22	-
6844	IQ24	-
6848	DG-106	-
6850	DG-101	-
6853	IW27	-
6868	IY27	-
6872	K20TXR	K20TT
6874	PK16TR13	IK16TT
6887	IW01-24	-
6891	IT20	IT20TT
6892	DG-005	-
6893	KJ16CR-L11	K16TT
6895	K20TNR	K20TT
6897	DG-145	-
6899	U20EPR9	-
6900	DG-104	-
6903	SK16PR-E11	IK16TT
6914	IU22	-
6928	W14EPR-U	IW16TT
6931	W20EKR-S11	IW20TT
6934	W22ESR-U	-
6943	DG-109	-
6945	T16PR-U15	ITF16TT
6950	T16PR-U15	ITF16TT
6951	IRE01-34	-
6953	K16PR-U11	K16TT
6955	U27ESR-NB	-
6962	K20PR-U	K20TT
6963	IK24C11	-
6965	U20ESR-N	-
6966	IUH27D	-
6968	IK24C11	-
6985	IU24A	-
6988	IK22	-
6989	ZT20EPR11	T20TT
6992	K20PBR-S10	K20TT
6993	K20TXR	K20TT
6994	SKJ20DR-M11	IK20TT
7001	IWF24	-
7003	IW16	IW16TT
7004	U22ETR	-
7021	W20MP-U	-
7022	W20FPR-U	WF20TT
7023	U20FSR-U	-
7026	IW20	IW20TT
7028	W20EKR-S11	IW20TT

NGK	DENSO	TT
7030	W20EKR-S11	IW20TT
7031	IW22	-
7035	IW27	-
7038	W14EXR-U	IW16TT
7043	RU01-34	-
7049	PK16PR11	K16TT
7050	IW01-34	-
7051	IW24	-
7052	T20R-U	-
7055	W16PR-U	-
7058	W27ES-V	-
7060	T20EPR-U	T20TT
7067	IWF22	-
7075	W16EPR-U	W16TT
7082	IW16	IW16TT
7084	IW20	IW20TT
7086	IQ16	IQ16TT
7088	IQ20	IQ20TT
7090	IK16	IK16TT
7092	IK20	IK20TT
7094	IQ20	IQ20TT
7098	IK16	IK16TT
7102	IW16	IW16TT
7112	X24FS-U	-
7113	K16HPR-U11	KH16TT
7121	Q20PR-U11	Q20TT
7124	IW27	-
7148	W27ESR-U	-
7149	IW16	IW16TT
7162	X24ESR-U	-
7164	IT20	IT20TT
7168	XU24EPR-U	-
7177	ITF20	ITF20TT
7204	W24FSR-U10	-
7210	Q20P-U11	Q20TT
7214	IW16	IW16TT
7221	W22MPR-U	-
7222	W14EPR-U	IW16TT
7223	U22FSR-U	-
7226	W22EPR-U11	W22TT
7227	DG-234	-
7236	IUF24	-
7237	IX24	-
7239	W27EBR	-
7240	T20R-U	-
7243	IT20	IT20TT
7250	IW22	-
7252	KJ20CR-L11	K20TT
7254	IW27	-
7264	W20EPBR-S	W20TT
7265	W22EPR-U	W22TT
7270	IW22	-
7272	ITF20	ITF20TT
7273	VKA16	-
7274	IUF22	-
7280	T20EPR-U15	T20TT
7281	W16EPR-U	W16TT
7300	IT16	IT16TT
7310	W20ESR-U	-
7311	W16EPR-U11	W16TT
7316	IT16	IT16TT
7321	W22MPR-U	-
7324	IW31	-
7327	W16EXR-U	W16TT
7331	W20FPR-U	WF20TT
7334	W20EPR-U11	W20TT
7335	IW31	-
7340	K20PR-U11	K20TT
7341	K22PR-U11	-
7348	ITF20	ITF20TT
7352	IW20	IW20TT

NGK	DENSO	TT
7354	K22TNR-S	-
7359	IQ02-24	-
7361	IQ20	IQ20TT
7373	K20PR-U	K20TT
7378	PKJ16CR8	-
7382	IQ27	-
7383	IWF24	-
7385	IU22	-
7386	TR22-10	-
7390	K16R-U	K16TT
7397	IT20	IT20TT
7400	RU01-31	-
7401	ITF16	ITF16TT
7411	N24EXRB	-
7415	VXU24	-
7418	SK16PR-A11	IK16TT
7421	W20MR-U	-
7422	W16EPR-U	W16TT
7423	U24FSR-U	-
7426	W16FPR-U	-
7429	W16FPR-U	-
7434	W20EKR-S11	IW20TT
7435	IWF22	-
7437	IX24B	-
7443	W20MP-U	-
7444	X31ETR	-
7445	IQ16	IQ16TT
7447	SF-24	-
7449	W27EBR	-
7450	IW01-29	-
7451	IW01-24	-
7452	IXU01-31	-
7453	IW31	-
7455	IW01-27	-
7457	IWM01-31	-
7460	IW24	-
7461	IQ31	-
7464	DG-114	-
7466	IW24	-
7468	IWF22	-
7469	T16EPR-U15	T16TT
7471	U24ES-N	-
7472	W22MPR-U	-
7473	U24FE9	-
7477	PK16R11	K16TT
7479	X27ETR	-
7480	W29EBR	-
7481	IXU01-34	-
7482	IW01-34	-
7483	IW01-29	-
7484	IX27	-
7485	IWM01-29	-
7487	IW22	-
7490	IW27	-
7492	DG-223	-
7493	DG-232	-
7496	Q16R-U	Q16TT
7497	W22M-U	-
7498	IW27	-
7499	U27ES-N	-
7502	U27FER9	-
7503	DG-007	-
7505	VKH20	IKH20TT
7509	S22PR-A7	-
7512	X20ESR-U	-
7516	ITF20	ITF20TT
7524	IW16	IW16TT
7526	W27ESR-U	-
7528	W14EXR-U11	IW16TT
7529	W20EP-U	W20TT
7532	W16EXR-U11	W16TT

NGK	DENSO	TT
7537	W16EXR-U	W16TT
7541	P16PR11	W16TT
7542	IW01-27	-
7544	IUF22	-
7545	DG-004	-
7546	U22ETR	-
7548	W27ESR	-
7549	IT16	IT16TT
7550	PKJ20CR8	-
7553	K16TNR-S9	K16TT
7556	VUH27ES	-
7559	ITF16	ITF16TT
7560	DG-177	-
7569	ZT20EPR11	T20TT
7586	PT16VR13	TV16TT
7588	ITF20	ITF20TT
7598	IW27	-
7611	W20EX-U	W20TT
7612	W16LS	-
7613	W31ESR-U	-
7623	W14FPR-UL	-
7625	DG-236	-
7626	W9FP-UL	-
7632	W16EXR-U	W16TT
7634	W16EXR-U11	W16TT
7637	W24FSR-U10	-
7639	W20EP-U	W20TT
7641	IU01-31	-
7642	K16PR-U	K16TT
7648	DG-008	-
7654	VKH20	IKH20TT
7658	VK20	IK20TT
7659	K20TNR-S9	K20TT
7669	IUF24	-
7677	W9LMR-US	-
7680	IW31	-
7681	IQ22	-
7682	IX22B	-
7684	IU24A	-
7697	W24FSR	-
7711	W20EXR-U11	W20TT
7717	DG-109	-
7718	VXUH22I	-
7726	IW20	IW20TT
7727	W20EX-U	W20TT
7732	W16EPR-U11	W16TT
7736	IQ01-31	-
7738	W22ETR-L	-
7740	PT16EPR-L13	IT16TT
7742	VKA16	-
7743	SKJ16CR-L11	IK16TT
7746	SK22PR-M11S	-
7748	VKA16	-
7750	IUH24	-
7755	IK16	IK16TT
7756	IRE01-34	-
7763	IW01-27	-
7768	DG-190	-
7771	DG-702	-
7772	PK22PR-L11S	-
7773	ITF20	ITF20TT
7781	IK16L	IK16TT
7782	DG-214	-
7784	U24ESR-NB	-
7785	IU27A	-
7788	W27ESR	-
7789	IXU22	-
7790	PKJ20CR-L11	IK20TT
7791	IU01-24	-
7792	IU01-27	-
7794	DG-140	-

Spark & Glow Plugs

Cross Reference Chart - Competitor

NGK	DENSO	TT
7795	IXU27	-
7803	IX22B	-
7810	Q16R-U11	Q16TT
7811	W20EPR-U	W20TT
7822	W20EPR-U	W20TT
7823	W14FPR-UL	-
7824	IW20	IW20TT
7825	DG-226	-
7829	W22FP-U10	-
7834	W16EXR-U	W16TT
7836	IWF22	-
7837	T20EPR-U	T20TT
7839	X22ESR-U	-
7840	U16FSR-U	-
7841	PK20PR11	K20TT
7852	W22FSR	-
7854	SK16PR-L11	IK16TT
7862	PT16EPR-L13	IT16TT
7866	SK16PR-A11	IK16TT
7870	IXU24	-
7873	K22PBR-S	-
7880	DG-124	-
7892	K20TXR	K20TT
7901	VX22BC	-
7906	DG-001	-
7909	M24S	-
7910	W20ESR-U	-
7912	X22ESR-U	-
7913	VKH20Y	-
7917	KJ16CR-L11	K16TT
7925	DG-130	-
7926	W9FP-UL	-
7928	W31ESR-U	-
7937	W24FR-L	-
7938	K16PR-U	K16TT
7947	DG-012	-
7956	K20TXR	K20TT
7957	DG-181	-
7960	VXUHC22G	-
7963	PK22PR8	-
7967	IU20	-
7968	PKJ16CR-L11	IK16TT
7980	ZXU20PR11	-
7986	W24ESR-U	-
7992	DG-155	-
7994	SK16PR-A11	IK16TT
7995	DG-108	-
7998	K20PBR	K20TT
8013	IWF24	-
8027	IXU27	-
8196	IXU22	-
8201	IY24	-
8643	DG-606	-
8659	VKH20Y	-
8838	DG-300	-
8851	DG-603	-
8888	DG-193	-
8894	KJ20CR-L11	K20TT
8902	DG-187	-
8904	DG-603	-
8939	DG-181	-
8944	DG-174	-
90002	DG-196	-
9029	FXE20HR11	IXEH20TT
90448	T22EP-U	-
90784	DG-171	-
90813	VT16	IT16TT
90828	DG-196	-
90852	K20TXR	K20TT
90860	DG-621	-
90888	K20PR-U11	K20TT

NGK	DENSO	TT
91015	KJ16CR-U11	K16TT
91039	VK22	-
91064	IU24	-
91083	K20TXR	K20TT
91322	DG-180	-
9138	DG-118	-
91406	W20EPR-U	W20TT
91440	DG-610	-
91597	K16PR-U11	K16TT
91648	DG-607	-
91691	FXE20HE11	IXEH20ETT
91722	K20PBR-S10	K20TT
91763	KJ16CR-U11	K16TT
91766	DG-126	-
91843	DG-602	-
9198	IU24D	-
92010	W20FPR-U	WF20TT
92083	DG-600	-
92402	VXU22	-
92406	T20EPR-U	T20TT
92483	XU20HR9	-
92491	VFKH20	IKH20TT
92610	K20TXR	K20TT
92734	K20HR-U11	KH20TT
93030	XE20HR-U9	IXEH20TT
9329	SKJ20DR-M11S	-
93293	DG-197	-
93298	VKH16	IKH16TT
93311	IXU27	-
93322	PK22PR8	-
93482	VFXEH22	IXEH22TT
93623	VK22	-
93707	DG-621	-
93759	VFKH16	IKH16TT
93815	VXUH20I	-
94001	KJ20DR-M11	IK20TT
94024	W20EPBR-S	W20TT
94037	XU22EPR-U	XU22TT
94040	VKH20Y	-
94067	K20PR-U	K20TT
94103	DG-609	-
94124	VCH20	IXEH22TT
94167	DK20PR-D13	-
94251	DG-608	-
94288	DG-305	-
94313	W20FPR-U	WF20TT
94460	IK24	-
94470	DG-305	-
94542	DG-186	-
9456	DG-121	-
94629	DG-195	-
94716	VXUH22	-
94811	W20EPR-U	W20TT
94832	DG-130	-
95173	DG-605	-
95264	IXUH20I	-
95369	ITV22	-
95420	T20TT	T20TT
95437	T16EPR-U	T16TT
95626	T20EPR-U	T20TT
95737	W16EPR-U	W16TT
95820	VK22	-
95836	DG-608	-
95843	VFXEH20	IXEH20TT
95970	DG-176	-
96062	DG-619	-
96178	Q20PR-U	Q20TT
96187	DG-602	-
96209	SKJ20CR-A8	-
96289	DG-176	-
96404	W16EPR-U	W16TT

NGK	DENSO	TT
96463	T16VR-U10	TV16TT
96478	DG-604	-
96498	SKJ20CR-A8	-
96523	KJ16CR-L11	K16TT
96569	XUH20TTi	XUH20TTi
96628	K16PR-U	K16TT
96723	K20PBR-S10	K20TT
96779	SK16HR11	IKH16TT
96853	DG-195	-
96870	ITV22	-
97195	Q16PR-U	Q16TT
9723	VXUH22I	-
97237	KJ20DR-M11	IK20TT
97256	DG-171	-
97374	K16HPR-U11	KH16TT
97387	PK20PR-P8	IK20TT
97416	W22EPR-U	W22TT
97472	XU22EPR-U	XU22TT
97719	DG-621	-
97725	W20EPBR-S	W20TT
9776	DG-177	-
97786	PKJ16CR-L11	IK16TT
97999	IXUH22I	-
99404	SK20PR-A8	IK20TT
9974	DG-172	-
A5FS	MA16PR-U	-
A-6	M17	-
A6FS	MA20PR-U	-
A7	M22	-
A8	M24S	-
AB-6	MW17	-
AB-7	M22	-
AB-8	M24S	-
AP4FS	MA9P-U	-
AP5FS	MA16PR-U	-
AP6F	MA20P-U	-
AP6FS	MA20P-U	-
AP6FVG	MA20P-U	-
APR5FS	MA16PR-U	-
APR5FS11	MA16PR-U	-
APR5FS15	MA16PR-U	-
APR6F	MA20PR-U	-
APR6FS	MA20PR-U	-
AR5FS	MA16PR-U	-
AR6	L14-U	-
AR6FS	MA20PR-U	-
AR6FS11	MA20PR-U	-
B105EGP	IW01-32	-
B105EGV	IW01-32	-
B105EP	IW01-32	-
B10ECS	W31ESR-U	-
B10EG	IW31	-
B10EGP	IW01-31	-
B10EGV	IW31	-
B10EN	IW31	-
B10EP	IW31	-
B10ES	W31ESR-U	-
B10EV	IW31	-
B10EVX	IW31	-
B10H	W31FS	-
B10HS	W31FS	-
B10HVX	W31FS	-
B11EG	IW34	-
B11EGP	IW01-34	-
B11EGV	IW34	-
B11EN	IW34	-
B11EP	IW34	-
B2	W9-U	-
B210	W9-U	-
B2LM	W9LM-US	-
B2LMY	W9LM-US	-

NGK	DENSO	TT
B4	W14PR-U	-
B410	W14PR-U	-
B4ES	W14E	-
B4H	W14F-U	-
B4H10	W14F-U	-
B4HS	W14F-U	-
B4L	W14L	-
B4LM	W14LM-U	-
B4LMY	W14LM-U	-
B5EB	W16ESR-U	-
B5EB11	W16EKR-S11	W16TT
B5ES	W16ESR-U	-
B5ES11	W16ESR-U	-
B5EV	IW16	IW16TT
B5HS	W16FSR	-
B5HS15	W16FSR	-
B5S	W16S-U	-
B6EB	W20EKR-S11	IW20TT
B6EB11	W20EKR-S11	IW20TT
B6EBL11	W20EKR-S11	IW20TT
B6ECS	W20ESR-U	-
B6EFS	T20EPR-U	T20TT
B6ES	W20ESR-U	-
B6ES11	W20ESR-U	-
B6EV	IW20	IW20TT
B6EVX	IW20	IW20TT
B6FS	T20R-U	-
B6HS	W20FSR-U	WF20TT
B6HS-10	W20FSR-U	WF20TT
B6HS-5	W20FSR-U	WF20TT
B6HSA	W20FSR-U	WF20TT
B6HV	IWF22	-
B6HVX	IWF22	-
B6L	W16LS	-
B6LY	W16LS	-
B6S	W20S-U	-
B6Y	W20S-U	-
B77HC	W24FSR	-
B7EB	IW22	-
B7EB11	IW22	-
B7ECS	W22ESR-U	-
B7EG	IW24	-
B7EM	W22EBR	-
B7ES	W22ES-U	-
B7ES11	W22ESR-U	-
B7ET	W22EBR	-
B7EV	W22ESR-U	-
B7EVX	W22ESR-U	-
B7HCS	W22FS-U	-
B7HS	W22FS-U	-
B7HS10	W22FS-U	-
B7HV	IWF22	-
B7HVX	IWF22	-
B7S	W22S-U	-
B85EGP	IW01-24	-
B85EGV	IW27	-
B8ECS	W24ESR-U	-
B8EFS	IT24	-
B8EG	W24ES-V	-
B8EGP	IW01-24	-
B8EGV	IW24	-
B8EM	IRE01-27	-
B8EMV	W27EBR	-
B8EN	IW24	-
B8EP	IW24	-
B8ES	W24ESR-U	-
B8ES11	W24ESR-U	-
B8ET	IRE01-27	-
B8EV	IW24	-
B8EVX	IW24	-
B8HCS	W24FSR	-

Spark & Glow Plugs

Cross Reference Chart - Competitor

NGK	DENSO	TT
B8HCS10	IWF24	-
B8HS	W24FSR	-
B8HS10	W24FSR-U10	-
B8HSA	W24FR-L	-
B8HV	IWF24	-
B8HVX	IWF24	-
B8S	W24S-U	-
B8X	L14-U	-
B95EG	IW29	-
B95EGP	IW01-29	-
B95EGV	IW29	-
B95EN	IW31	-
B95EP	IW29	-
B9ECS	W27ES-V	-
B9EFS	IT27	-
B9EG	W27ES-V	-
B9EGP	IW27	-
B9EGV	IW27	-
B9EM	IRE01-27	-
B9EN	IW27	-
B9EP	IW27	-
B9ES	W27ESR-U	-
B9EV	IW27	-
B9EVX	IW27	-
B9HCS	IWF27	-
B9HCV	IWF27	-
B9HN	IWF27	-
B9HP	IWF27	-
B9HS	W27FSR	-
B9HS10	W27FSR-U10	-
B9HV	IWF27	-
B9HVX	IWF27	-
B9S	W27S-U	-
BC6ES	W20ESR-U	-
BC9ECS	IQ27	-
BCP4ES	Q14R-U11	IQ16TT
BCP4ES11	Q14R-U11	IQ16TT
BCP5E	Q16PR-U11	Q16TT
BCP5E11	Q16PR-U11	Q16TT
BCP5ES	Q16R-U	Q16TT
BCP5ES11	Q16R-U11	Q16TT
BCP5ET	K20PBR	K20TT
BCP5EV	IQ16	IQ16TT
BCP5EV11	IQ16	IQ16TT
BCP5EVX	IQ16	IQ16TT
BCP5EVX11	IQ16	IQ16TT
BCP5EY	Q16R-U	Q16TT
BCP5EY-11	Q16R-U11	Q16TT
BCP6E	Q20PR-U	Q20TT
BCP6E11	Q20P-U11	Q20TT
BCP6ES	Q20R-U	Q20TT
BCP6ES11	Q20P-U11	Q20TT
BCP6ET	K20PBR	K20TT
BCP6EV	IQ20	IQ20TT
BCP6EV11	IQ20	IQ20TT
BCP6EVX	IQ20	IQ20TT
BCP6EVX11	IQ20	IQ20TT
BCP6EY11	Q20R-U11	Q20TT
BCP7E	Q22PR-U	-
BCP7E11	Q22PR-U11	-
BCP7ES	Q22PR-U	-
BCP7ES11	Q22PR-U11	-
BCP7ET	K22PB	-
BCP7EV	IQ22	-
BCP7EV11	IQ22	-
BCP7EVX	IQ22	-
BCP7EVX11	IQ22	-
BCP8EVX11	IQ24	-
BCPR4ES	Q14R-U11	IQ16TT
BCPR4ES-11	Q14R-U11	IQ16TT
BCPR4EY	Q14R-U11	IQ16TT

NGK	DENSO	TT
BCPR4EY11	Q14R-U11	IQ16TT
BCPR5E	Q16PR-U	Q16TT
BCPR5E11	Q16PR-U11	Q16TT
BCPR5EGP	IQ16	IQ16TT
BCPR5EIX	IQ16	IQ16TT
BCPR5EIX11	IQ16	IQ16TT
BCPR5EIX11P	PQ16R	Q16TT
BCPR5EP11	PQ16R	Q16TT
BCPR5EP13	IQ16	IQ16TT
BCPR5EP8	PQ16R8	Q16TT
BCPR5EPN11	VQ16	IQ16TT
BCPR5ES	Q16PR-U	Q16TT
BCPR5ES-11	Q16PR-U11	Q16TT
BCPR5ET	K20PBR	K20TT
BCPR5EV	IQ16	IQ16TT
BCPR5EV11	IQ16	IQ16TT
BCPR5EVX	IQ16	IQ16TT
BCPR5EVX11	IQ16	IQ16TT
BCPR5EY	Q16R-U	Q16TT
BCPR5EY11	Q16R-U11	Q16TT
BCPR5EYN11	Q16R-U11	Q16TT
BCPR6E	Q20PR-U	Q20TT
BCPR6E11	Q20PR-U11	Q20TT
BCPR6EGP	IQ20	IQ20TT
BCPR6EIX	IQ20	IQ20TT
BCPR6EIX11	IQ20	IQ20TT
BCPR6EIX11P	PQ20R	Q20TT
BCPR6EP11	PQ20R	Q20TT
BCPR6EP-13	PQ20R	Q20TT
BCPR6EP8	PQ20R	Q20TT
BCPR6EPN11	VQ20	IQ20TT
BCPR6EPN8	PQ20R-P8	IQ20TT
BCPR6ER	K20TXR	K20TT
BCPR6ES	Q20PR-U	Q20TT
BCPR6ES-11	Q20PR-U11	Q20TT
BCPR6ET	K20PBR	K20TT
BCPR6EV	IQ20	IQ20TT
BCPR6EV11	IQ20	IQ20TT
BCPR6EVX	IQ20	IQ20TT
BCPR6EVX11	IQ20	IQ20TT
BCPR6EY	Q20R-U	Q20TT
BCPR6EY11	Q20R-U11	Q20TT
BCPR6EYN11	Q20R-U11	Q20TT
BCPR7E	Q22PR-U	-
BCPR7E11	Q22PR-U11	-
BCPR7EIX	IQ22	-
BCPR7EIX-11	IQ22	-
BCPR7ES	Q22PR-U	-
BCPR7ES-11	Q22PR-U11	-
BCPR7ET	K22PBR-S	-
BCPR7EV	IQ22	-
BCPR7EV11	IQ22	-
BCPR7EVX	IQ22	-
BCPR7EVX11	IQ22	-
BCPR7EY	Q22PR-U	-
BCPR7EY11	Q22PR-U11	-
BCPR7EYN11	Q22PR-U11	-
BCPR8EVX11	IQ24	-
BCPR9ES11	IQ27	-
BCR7ES	Q22PR-U	-
BCR8ES	IQ24	-
BCRE527Y	QJ16AR-U	-
BCRE527Y11	QJ16AR-U11	-
BE527Y11	J16AR-U11	-
BE529Y11	J16BR-U	-
BK5E	K16PR-U	K16TT
BK5E11	K16PR-U11	K16TT
BK5ES	K16PR-U	K16TT
BK5ESZ	K16PR-U	K16TT
BK6E	K20P-U	K20TT
BK6E11	K20PR-U11	K20TT

NGK	DENSO	TT
BK6EKU	K20TXR	K20TT
BK7E	K22PR-U	-
BK7E11	K22PR-U11	-
BK7EKN11	IK22	-
BK7EKU	IK22	-
BKR4E	IK16	IK16TT
BKR4E-11	IK16	IK16TT
BKR4EIX	IK16	IK16TT
BKR4ESA11	IK16	IK16TT
BKR4EVX	IK16	IK16TT
BKR5E	K16PR-U	K16TT
BKR5E-11	K16PR-U11	K16TT
BKR5EE	IK16	IK16TT
BKR5EGP	IK16	IK16TT
BKR5EIX	IK16	IK16TT
BKR5EIX11	IK16	IK16TT
BKR5EIX11P	VK16	IK16TT
BKR5EIXP	VK16	IK16TT
BKR5EK	K20TXR	K20TT
BKR5EK11	K16TR11	K16TT
BKR5EKB11	K16TR11	K16TT
BKR5EK9	K16TNR-S9	K16TT
BKR5EK9	K16TNR-S9	K16TT
BKR5EKPB11	PK16TR11	K16TT
BKR5EKPB13	PK16TR13	IK16TT
BKR5EKU	K20TXR	K20TT
BKR5EKUC	VKA16	-
BKR5EKUD	VKA16	-
BKR5EKUP	K20TXR	K20TT
BKR5EN	K16PR-U	K16TT
BKR5EN11	K16PR-L11	K16TT
BKR5EP11	PK16R11	K16TT
BKR5EP13	PK16R11	K16TT
BKR5EP8	PK16R8	IK16TT
BKR5EQUB	K20TXR	K20TT
BKR5EQUPA	VK16	IK16TT
BKR5ERX-11P	VFK16	IK16TT
BKR5ERX-P	VFK16	IK16TT
BKR5ES	K16PR-U	K16TT
BKR5ES11	K16PR-U11	K16TT
BKR5ESA11	K16PR-U11	K16TT
BKR5ESZA	VKA16	-
BKR5EVX	IK16	IK16TT
BKR5EVX-11	IK16	IK16TT
BKR5EVXA	IK16	IK16TT
BKR5EXA13	IK16	IK16TT
BKR5EY	K16R-U	K16TT
BKR5EY11	K16R-U11	K16TT
BKR5EYA	K16R-U	K16TT
BKR5EYA11	K16R-U11	K16TT
BKR5EZ	K16PR-U	K16TT
BKR6E	K20PR-U	K20TT
BKR6E-11	K20PR-U11	K20TT
BKR6E9S	IK20G	-
BKR6EE	IK20	IK20TT
BKR6EGP	IK20	IK20TT
BKR6EIX	IK20	IK20TT
BKR6EIX11	IK20	IK20TT
BKR6EIX11P	VK20	IK20TT
BKR6EIXLP	VK20T	IK20TT
BKR6EIXP	VK20Y	-
BKR6EK	K20TXR	K20TT
BKR6EKB11	K20TR11	K20TT
BKR6EKC	K20TNR	K20TT
BKR6EKN11	K20TNR	K20TT
BKR6EKE	K20TXR	K20TT
BKR6EKPA	PK20TR11	K20TT
BKR6EKPB11	PK20TR11	K20TT
BKR6EKU	K20TXR	K20TT
BKR6EKUB	K20TXR	K20TT

NGK	DENSO	TT
BKR6EKUC	VKA20	-
BKR6EKUD	VKA20	-
BKR6EKUE	K20TXR	K20TT
BKR6EN	K20PR-U	K20TT
BKR6EN11	K20PR-L11	K20TT
BKR6EP11	PK20R11	K20TT
BKR6EP13	PK20R13	K20TT
BKR6EP8	PK20R8	IK20TT
BKR6EPA8	PK20GR8	-
BKR6EPN11	PK20PR-L11	IK20TT
BKR6EPN8	PK20R-P8	IK20TT
BKR6EQU	K20TXR	K20TT
BKR6EQUA	K20TXR	K20TT
BKR6EQUB	K20TXR	K20TT
BKR6EQUP	K20TXR	K20TT
BKR6EQUPA	K20TXR	K20TT
BKR6ES	K20PR-U	K20TT
BKR6ES11	K20PR-U11	K20TT
BKR6ESZ10	K20PR-U11	K20TT
BKR6ETA10	K20PBR	K20TT
BKR6ETP	SK20PR-A8	IK20TT
BKR6ETUB	K20PBR-S10	K20TT
BKR6ETUC	K20TXR	K20TT
BKR6EVX	IK20	IK20TT
BKR6EVX11	IK20	IK20TT
BKR6EVXA11	IK20	IK20TT
BKR6EVXA13	IK20	IK20TT
BKR6EY	K20R-U	K20TT
BKR6EY11	K20R-U11	K20TT
BKR6EYA	K20R-U	K20TT
BKR6EYA11	K20R-U11	K20TT
BKR6EZ	K20PR-U	K20TT
BKR6EZB	K20PR-U11	K20TT
BKR7E	K22PR-U	-
BKR7E11	K22PR-U11	-
BKR7EE	IK22	-
BKR7EIX	IK22	-
BKR7EIX11	IK22	-
BKR7EIX11PS	VK22G	-
BKR7EIXP	VK22	-
BKR7EIXPS	VK22	-
BKR7EKC	K22TNR-S	-
BKR7EKN	IK22	-
BKR7EKN11	IK22	-
BKR7EKN11	IK22	-
BKR7EKN11	IK22	-
BKR7EKN11	IK22	-
BKR7EKU	K22TNR-S	-
BKR7EN11	K22PR-L11	-
BKR7EQUP	IK22	-
BKR7ES	K22PR-U	-
BKR7ES-11	K22PR-U11	-
BKR7ESC-11	K22PR-U11	-
BKR7EVX	IK22	-
BKR7EVX11	IK22	-
BKR7EY	K22PR-U	-
BKR7EY11	K22PR-U11	-
BKR8E11	K24PR-U11	-
BKR8EIX	IK24	-
BKR9EIX	IK27	-
BKRGAS	VK20T	IK20TT
BKUR5EK9	K16TNR-S9	K16TT
BKUR5ET	K16TNR-S9	K16TT
BKUR5ET10	K16TNR-S9	K16TT
BKUR5ETC10	K16TNR-S9	K16TT
BKUR5ETZ10	K16TNR-S9	K16TT
BKUR6E	IK20	IK20TT
BKUR6EK	K20TNR-S	K20TT
BKUR6EK9	K20TNR-S9	K20TT
BKUR6EKPA	PK20TR-S9	K20TT
BKUR6ET	K20PBR-S10	K20TT
BKUR6ET-10	K20PBR-S10	K20TT
BKUR6ETB	K20PBR-S10	K20TT

Spark & Glow Plugs

Cross Reference Chart - Competitor

NGK	DENSO	TT
BKUR6ETB10	K20PBR-S10	K20TT
BKUR7E11	IK22	-
BKUR7EK	K22TNR-S	-
BKUR7ET	K22PBR-S	-
BM4A	W14MR-U	-
BM6	W20MR-U	-
BM6A	W20MR-U	-
BM6F	T20M-U	-
BM6FY	T20M-U	-
BM7	W22M-U	-
BM7A	W22M-U	-
BM7F	T22M-U	-
BMR2A	W9LMR-US	-
BMR2A10	W9LMR-US	-
BMR4A	W14MR-U	-
BMR6A	W20MR-U	-
BMR6F	T20M-U	-
BMR7A	W22M-U	-
BP10EV	IW31	-
BP10EVX	IW31	-
BP2E	W9EXR-U+CU	-
BP2ES	W9EP	-
BP2HA	W9FP-UL	-
BP2HS	W9FP-UL	-
BP4	W14PR-U	-
BP4E	W14EX-U	IW16TT
BP4EA11	W14EXR-U11	IW16TT
BP4EFS	T16EPR-U	T16TT
BP4ES	W14EPR-U	IW16TT
BP4ES11	W14EXR-U11	IW16TT
BP4ES13	W14EXR-U11	IW16TT
BP4ESL11	W14EXR-U11	IW16TT
BP4EY	W14EX-U	IW16TT
BP4EY11	W14EXR-U11	IW16TT
BP4FS	T14PR-U	ITF16TT
BP4H	W14FPR-U	-
BP4HA	W14FPR-UL	-
BP4HM10	W14FPR-UL10	-
BP4HS	W14FPR-UL	-
BP4HS10	W14FPR-UL10	-
BP4HSA	W14FPR-UL	-
BP5E	W16EPR-U	W16TT
BP5EA	W14EX-U	IW16TT
BP5EA11	W14EXR-U11	IW16TT
BP5EA13	W14EXR-U11	IW16TT
BP5EAL	W16EXR-U	W16TT
BP5EAL11	W16EXR-U11	W16TT
BP5EFS	T16EPR-U	T16TT
BP5EFS13	T16EPR-U15	T16TT
BP5EKA	W16ETR-S	W16TT
BP5EKN	W16ETR-S	W16TT
BP5EQ13	W16EPR-U11	W16TT
BP5ES	W16EPR-U	W16TT
BP5ES11	W16EPR-U11	W16TT
BP5ES13	W16EXR-U13	W16TT
BP5ESA	W16EPR-U	W16TT
BP5ESL	W16EPR-U	W16TT
BP5ESZ	W16EXR-U	W16TT
BP5ET	W16EPB10	W16TT
BP5ET10	W16EPB10	W16TT
BP5EV	IW16	IW16TT
BP5EVX	IW16	IW16TT
BP5EVX-11	IW16	IW16TT
BP5EY	W16EXR-U	W16TT
BP5EY11	W16EXR-U11	W16TT
BP5EZ	W16EPR-U	W16TT
BP5F	T16PR-U	ITF16TT
BP5FS	T16PR-U	ITF16TT
BP5HA	W16FPR-U	-
BP5HM	W16FPR-U	-
BP5HS	W16FPR-U	-

NGK	DENSO	TT
BP5HS10	W16FPR-U	-
BP5S	W16PR-U	-
BP6E	W20EP-U	W20TT
BP6EA	W20EX-U	W20TT
BP6EA11	W20EXR-U11	W20TT
BP6EF	T20EPR-U	T20TT
BP6EF-13	T20EPR-U15	T20TT
BP6EFS	T20EPR-U	T20TT
BP6EFS13	T20EPR-U15	T20TT
BP6EK	IW20	IW20TT
BP6EKA	IW20	IW20TT
BP6EKN	W20ETR-L	IW20TT
BP6EQ13	W20EPR-U11	W20TT
BP6ES	W20EPR-U	W20TT
BP6ES11	W20EPR-U11	W20TT
BP6ES13	W20EXR-U11	W20TT
BP6ESA	W20EPR-U	W20TT
BP6ESZ	W20EP-U	W20TT
BP6ET	W20EPB	W20TT
BP6EV	IW20	IW20TT
BP6EVX	IW20	IW20TT
BP6EVX-11	IW20	IW20TT
BP6EY	W20EX-U	W20TT
BP6EY11	W20EXR-U11	W20TT
BP6EZ	W20EPR-U	W20TT
BP6F	T20PR-U	ITF20TT
BP6FS	T20PR-U	ITF20TT
BP6H	W20FPR-U	WF20TT
BP6HK	W20FR-L	WF20TT
BP6HS	W20FPR-U	WF20TT
BP6HS10	W20FPR-U10	WF20TT
BP6HSA	W20FR-L	WF20TT
BP6HV	IWF20	-
BP6HV-G	IWF20	-
BP6HVX	IWF20	-
BP6S	W20PR-U	-
BP7E	W22EPR-U	W22TT
BP7EFS	T22EP-U	-
BP7EFVX	IT22	-
BP7EKN	W22ETR-L	-
BP7EQ13	W22EPR-U11	W22TT
BP7ES	W22EPR-U	W22TT
BP7ES11	W22EPR-U11	W22TT
BP7ET	W22EPB	W22TT
BP7EV	IW22	-
BP7EVX	IW22	-
BP7EVX11	IW22	-
BP7EY	W22EPR-U	W22TT
BP7EY11	W22EPR-U	W22TT
BP7FS	ITF22	-
BP7HS	W22FPR-U	-
BP7HS10	W22FP-U10	-
BP7HV	IWF22	-
BP7HVX	IWF22	-
BP8ES	W24EPR-U	-
BP8ES11	W24EPR-U	-
BP8EV	IW24	-
BP8EVX	IW24	-
BP8FS	ITF24	-
BP8HM10	W24FPR-U10	-
BP8HS	W24FP-U	-
BP8HS10	W24FPR-U10	-
BP8HS15	W24FPR-U10	-
BP8HSA	W24FR-L	-
BP8HSN10	W24FP-U	-
BP9ES	W27ESR-U	-
BP9EV	IW27	-
BP9EVX	IW27	-
BP9HS	W27FSR	-
BP9HVX	IWF27	-
BPM4A	W14MP-U10	-

NGK	DENSO	TT
BPM4A10	W14MP-U10	-
BPM6A	W20MP-U	-
BPM6A10	W20MPR-U10	-
BPM6F	T20MP-U	-
BPM6Y	W20MP-U	-
BPM7	W22MPR-U	-
BPM7A	W22MPR-U	-
BPM7F	T22MP-U	-
BPM7Y	W22MPR-U	-
BPMR4A	W14MPR-U10	-
BPMR4A10	W14MPR-U10	-
BPMR6A	W20MPR-U10	-
BPMR6A10	W20MPR-U10	-
BPMR6F	T20MP-U	-
BPMR6Y	W20MPR-U10	-
BPMR7A	W22MPR-U	-
BPR10EV	IW31	-
BPR10EVX	IW31	-
BPR2E	W9EXR-U+CU	-
BPR2ES	W9EXR-U+CU	-
BPR2HS	W9FP-UL	-
BPR4E	W14EPR-U	IW16TT
BPR4EFS	IT16	IT16TT
BPR4ES	W14EXR-U	IW16TT
BPR4ES11	W14EXR-U11	IW16TT
BPR4ES13	W14EXR-U11	IW16TT
BPR4ESL11	W14EXR-U11	IW16TT
BPR4EVX	IW16	IW16TT
BPR4EY	W14EXR-U	IW16TT
BPR4EY11	W14EXR-U11	IW16TT
BPR4EY13	W14EXR-U11	IW16TT
BPR4FS	T14PR-U	ITF16TT
BPR4FS11	T14PR-U	ITF16TT
BPR4FS15	T14PR-U	ITF16TT
BPR4FS20	T14PR-U	ITF16TT
BPR4H	W14FPR-UL	-
BPR4HS	W14FPR-UL	-
BPR4HS10	W14FPR-UL10	-
BPR4HSA	W14FPR-UL	-
BPR4S	W14PR-U	-
BPR4S15	W14PR-U	-
BPR4S20	W14PR-U	-
BPR5E	W16EPR-U	W16TT
BPR5E11	W16EPR-U11	W16TT
BPR5EA	W14EXR-U	IW16TT
BPR5EA11	W14EXR-U11	IW16TT
BPR5EAL	W16EXR-U	W16TT
BPR5EAL11	W16EXR-U11	W16TT
BPR5EF	T16EPR-U	T16TT
BPR5EF-13	T16EPR-U15	T16TT
BPR5EFIX13P	VT16	IT16TT
BPR5EFS	T16EPR-U	T16TT
BPR5EFS13	T16EPR-U15	T16TT
BPR5EFVX	IT16	IT16TT
BPR5EGP	IW16	IW16TT
BPR5EIX	IW16	IW16TT
BPR5EIX11	IW16	IW16TT
BPR5EIX11P	VW16	IW16TT
BPR5EIXP	VW16	IW16TT
BPR5EKA	W16ETR-S	W16TT
BPR5EKN	W16ETR-S	W16TT
BPR5EKU	W16ETR-S	W16TT
BPR5EP11	P16R	W20TT
BPR5EP-13	P16R13	W20TT
BPR5ES	W16EPR-U	W16TT
BPR5ES11	W16EXR-U11	W16TT
BPR5ES13	W16EXR-U13	W16TT
BPR5ES15	W16EPR-U11	W16TT
BPR5ESA	W16EXR-U	W16TT
BPR5ESL	W16EPR-U	W16TT
BPR5EV	IW16	IW16TT

NGK	DENSO	TT
BPR5EVX	IW16	IW16TT
BPR5EVX11	IW16	IW16TT
BPR5EY	W16EXR-U	W16TT
BPR5EY11	W16EXR-U11	W16TT
BPR5FS	T16PR-U	ITF16TT
BPR5FS11	T16PR-U11	ITF16TT
BPR5FS15	T16PR-U15	ITF16TT
BPR5HM	W16FPR-U	-
BPR5HS	W16FPR-U	-
BPR5S	W16PR-U	-
BPR5S15	W16PR-U	-
BPR6E	W20EPR-U	W20TT
BPR6E11	W20EPR-U	W20TT
BPR6EF	T20EPR-U	T20TT
BPR6EF11	T20TT	T20TT
BPR6EF13	T20EPR-U15	T20TT
BPR6EFIX-10	IT20	IT20TT
BPR6EFIX13P	VT20	IT20TT
BPR6EFIX15	IT20	IT20TT
BPR6EFS	T20EPR-U	T20TT
BPR6EFS13	T20EPR-U15	T20TT
BPR6EFS15	T20EPR-U15	T20TT
BPR6EGP	IW20	IW20TT
BPR6EIX	IW20	IW20TT
BPR6EIX11	IW20	IW20TT
BPR6EIX11P	VW20	IW20TT
BPR6EIX-LPG	VW20T	IW20TT
BPR6EIXP	VW20	IW20TT
BPR6EKA	IW20	IW20TT
BPR6EKN	W20ETR-L	IW20TT
BPR6EP11	VW20	IW20TT
BPR6ES	W20EPR-U	W20TT
BPR6ES11	W20EPR-U11	W20TT
BPR6ES13	W20EXR-U11	W20TT
BPR6ESN11	W20EPR-U11	W20TT
BPR6EV	IW20	IW20TT
BPR6EVX	IW20	IW20TT
BPR6EVX11	IW20	IW20TT
BPR6EY	W20EXR-U	W20TT
BPR6EY-11	W20EXR-U11	W20TT
BPR6EY13	W20EXR-U11	W20TT
BPR6EYZ	W20EXR-U	W20TT
BPR6EZ	W20EPR-U	W20TT
BPR6FS	T20PR-U	ITF20TT
BPR6FS11	T20PR-U11	ITF20TT
BPR6FS15	T20PR-U15	ITF20TT
BPR6H	W20FPR-U	WF20TT
BPR6HIX	IWF20	-
BPR6HS	W20FPR-U	WF20TT
BPR6HS10	W20FPR-U10	WF20TT
BPR6HSA	W20FR-L	WF20TT
BPR6HVX	IWF20	-
BPR6S	W20PR-U	-
BPR7E	W22EPR-U	W22TT
BPR7EFS	IT22	-
BPR7EFS15	IT22	-
BPR7EIX	IW22	-
BPR7EKN	W22ETR-L	-
BPR7ES	W22EPR-U	W22TT
BPR7ES11	W22EPR-U11	W22TT
BPR7EV	IW22	-
BPR7EVX	IW22	-
BPR7EVX11	IW22	-
BPR7EY	W22EPR-U	W22TT
BPR7EY11	W22EPR-U11	W22TT
BPR7HIX	IWF22	-
BPR7HS	W22FPR-U	-
BPR7HS10	W22FPR-U	-
BPR7HSA	W22FPR-U	-
BPR7HVX	IWF22	-
BPR8EIX	IW24	-

Spark & Glow Plugs

Cross Reference Chart - Competitor

NGK	DENSO	TT
BPR8ES	W24EPR-U	-
BPR8EV	IW24	-
BPR8EVX	IW24	-
BPR8HIX	IWF24	-
BPR8HS	W24FPR	-
BPR8HS10	W24FPR-U10	-
BPR8HSA	W24FR-L	-
BPR9EIX	IW27	-
BPR9ES	W27ESR	-
BPR9EV	IW27	-
BPR9EVX	IW27	-
BPRGAS	VW20T	IW20TT
BPZ7HS10	W22FPR-U	-
BPZ8HN10	W24FPR-U10	-
BPZ8HS10	W24FPR-U10	-
BPZ8HS15	W24FPR-U10	-
BR10ECM	IWM31	-
BR10ECMIX	IWM31	-
BR10ECMVX	IWM31	-
BR10ECS	W31ESR-U	-
BR10EG	IW31	-
BR10EGV	IW31	-
BR10EIX	IW31	-
BR10ES	W31ESR-U	-
BR10ET	W29EBR	-
BR10EV	IW31	-
BR10EVX	IW31	-
BR10EYA	W31ESR-U	-
BR2LM	W9LMR-US	-
BR4ES	W14E	-
BR4HS	W14FR-U	-
BR4HSA	W14FR-L	-
BR4LM	W14LM-U	-
BR5EB	W16ESR-U	-
BR5EB11	W16ESR-U	-
BR5EF	T16EPR-U	T16TT
BR5ES	W16ESR-U	-
BR5ES11	W16ESR-U	-
BR5FS	T16R-U	IT16TT
BR5FS15	T16R-U	IT16TT
BR5HS	W16FSR	-
BR6EB	W20ESR-U	-
BR6EB11	W20EKR-S11	IW20TT
BR6EBL	W20EKR-S11	IW20TT
BR6EBL11	W20EKR-S11	IW20TT
BR6EF	T20EPR-U	T20TT
BR6EFS	T20EPR-U	T20TT
BR6ES	W20ESR-U	-
BR6ES11	W20ESR-U	-
BR6FS	T20R-U	-
BR6FS15	T20R-U	-
BR6HIX	IWF22	-
BR6HS	W20FSR-U	WF20TT
BR6HS10	W20FSR-U	WF20TT
BR6HSA	W20FR-L	WF20TT
BR6S	W20SR-U	-
BR7EB	W22ESR-U	-
BR7EB11	W22ESR-U	-
BR7EF	T22EP-U	-
BR7EFS	T22EP-U	-
BR7EG	W22ESR-U	-
BR7EM	W22EBR	-
BR7ES	W22ESR-U	-
BR7ES11	W22ESR-U	-
BR7ET	W22EBR	-
BR7HIX	IWF22	-
BR7HS	W22FSR	-
BR7HS-10	W22FSR	-
BR8E1X	IW24	-
BR8ECM	W24EMR-C	-
BR8ECMIX	IWM24	-

NGK	DENSO	TT
BR8ECS	W24ESR-U	-
BR8ECSIX	IW01-24	-
BR8EG	W24ESR-V	-
BR8EIX	IW24	-
BR8EM	W27EBR	-
BR8ES	W24ESR	-
BR8ES11	W24ESR-U	-
BR8ET	W27EBR	-
BR8EV	IW24	-
BR8EVX	IW24	-
BR8HCS10	W24FSR-U10	-
BR8HIX	IWF24	-
BR8HS	W24FSR	-
BR8HS10	W24FSR-U10	-
BR8HSA	W24FR-L	-
BR8HV	IWF24	-
BR8HVX	IWF24	-
BR9E1X	IW27	-
BR9ECM	W27EMR-C	-
BR9ECMIX	IWM27	-
BR9ECMVX	IWM27	-
BR9ECS	W27ESR-V	-
BR9ECS-5	W27ESR-V	-
BR9ECSIX	IW01-27	-
BR9ECSIX5	IW01-27	-
BR9EG	W27ESR-V	-
BR9EGN8	W27ESR-V	-
BR9EGV	IW27	-
BR9EIX	IW27	-
BR9EQ14	IRE01-27	-
BR9ES	W27ESR-U	-
BR9ET	W27EBR	-
BR9EV	IW27	-
BR9EVX	IW27	-
BR9EYA	W27ESR	-
BR9HIX	IWF27	-
BR9HS	W27FSR	-
BR9HS10	W27FSR-U10	-
BR9HVX	IWF27	-
BRE527Y11	J16AR-U11	-
BRE529Y	J16AR-U11	-
BRE529Y11	J16BR-U	-
BU5EB11	W16EKR-S11	W16TT
BU6EA11	W20EPR-S11	W20TT
BU6EB11	W20EKR-S11	IW20TT
BU6EFSZ	T20EPR-U	T20TT
BU7EA11	IW22	-
BU7EB11	IW22	-
BU8H	SF-24	-
BUH	SF-50	-
BUHW	SF-50	-
BUHW2	SF-51	-
BUHX	SF-50	-
BUR5EA11	W16EPR-U11	W16TT
BUR5EB11	W16EKR-S11	W16TT
BUR5ET	W20EPBR-S	W20TT
BUR5ET-10	W20EPBR-S	W20TT
BUR5ETB10	W20EPBR-S	W20TT
BUR6EA11	W20EPR-S11	W20TT
BUR6EB11	W20EKR-S11	IW20TT
BUR6EBVX11	IW20	IW20TT
BUR6EFSZ	T20EPR-U	T20TT
BUR6ET	W20EPBR-S	W20TT
BUR7EA11	IW22	-
BUR7EB11	IW22	-
BUR7EQ	IRE01-27	-
BUR7EQP	IRE01-27	-
BUR8EQ	IRE01-27	-
BUR8EQP	IRE01-27	-
BUR9EQ	IRE01-27	-
BUR9EQP	IRE01-27	-

NGK	DENSO	TT
BUZ8H	SF-24	-
BUZHW	SF-50	-
BUZHW2	SF-51	-
BZ7HS10	W22FSR	-
BZ8ES	W24ESR-U	-
BZ9EV	IW27	-
C10EH9	U31ESR-N	-
C10H	IUF31A	-
C4H	U14FSR-UB	-
C4HA	U14FSR-UB	-
C4HSA	U14FSR-UB	-
C4HSB	U14FSR-UB	-
C5HA	U16FSR-U	-
C5HSA	U16FSR-U	-
C5HSB	U16FS-UB	-
C6H	U20FSR-U	-
C6HA	U20FSR-U	-
C6HSA	U20FSR-U	-
C7E	U22ESR-N	-
C7EH9	U22FER9	-
C7HA	U22FSR-U	-
C7HS	U22FSR-U	-
C7HSA	U22FSR-U	-
C7HV	IUF22	-
C7HVX	IUF22	-
C8E	U24ES-N	-
C8EH9	U24FE9	-
C8EHVX9	IUH24	-
C8EVX	IU24	-
C8HA	U24FSR-U	-
C8HSA	U24FSR-U	-
C8HV	IUF24	-
C8HVX	IUF24	-
C9E	U27ES-N	-
C9EH9	U27FER9	-
C9EHVX9	IUH27	-
C9EVX	IU27	-
C9H	IUF27A	-
CM-6	U20M-U	-
CPR6EA9	U20EPR9	-
CPR6EA-9S	U20EPR9	-
CPR6EB9	IU20	-
CPR7EA-9	U22EPR9	-
CPR7EAIX-9	IU24D	-
CPR8E	N24EXRB	-
CPR8EA9	U24EPR9	-
CPR8EB9	IU24	-
CPR9EA9	U27ESR-N	-
CPR9EB9	IU27	-
CR10E	U31ESR-N	-
CR10EH9	U31ESR-N	-
CR10EIA9	IU31	-
CR10EIX	IU31	-
CR10EK	U31ETR	-
CR4HSB	U14FSR-UB	-
CR5EH	U16FER9	-
CR5HS	U16FSR-U	-
CR5HSA	U16FSR-U	-
CR5HSB	U16FSR-UB	-
CR5HSB9	U16FSR-UB	-
CR6E	U20ESR-N	-
CR6EB	U20ESR-N	-
CR6EIA9	IU20	-
CR6HIX	IUF22	-
CR6HS	U20FSR-U	-
CR6HSA	U20FSR-U	-
CR6HSB	U20FSR-U	-
CR7E	U22ESR-N	-
CR7EB	IU22	-
CR7EB	U22ESR-NB	-
CR7EH9	U22FER9	-

NGK	DENSO	TT
CR7EIA9	IU22	-
CR7EIX	IU22	-
CR7EK	U22ETR	-
CR7EKA	U22ETR	-
CR7EKB	IU24A	-
CR7EKC	U22ETR	-
CR7HIX	IUF22	-
CR7HS	U22FSR-U	-
CR7HSA	U22FSR-U	-
CR7HSA9	U22FSR-U	-
CR7HVX	IUF22	-
CR7RK	U22ETR	-
CR8E	U24ESR-N	-
CR8EB	U24ESR-NB	-
CR8EH9	U24FER9	-
CR8EH9S	IUH24	-
CR8EHIX9	IUH24	-
CR8EHV	IUH24	-
CR8EHVX9	IUH24	-
CR8EIA	IU24	-
CR8EIA10	IU24	-
CR8EIA-9	IU24	-
CR8EIB	IU24	-
CR8EIB10	IU24	-
CR8EIX	IU24	-
CR8EK	U24ETR	-
CR8EKB	IU24A	-
CR8EKPA	IU24A	-
CR8EVX	IU24	-
CR8HIX	IUF24	-
CR8HS	U24FSR-U	-
CR8HSA	U24FSR-U	-
CR8HVX	IUF24	-
CR8RK	U24ETR	-
CR9E	U27ESR-N	-
CR9EB	U27ESR-NB	-
CR9EH9	U27FER9	-
CR9EH9S	IUH27	-
CR9EHIX9	IUH27	-
CR9EHV	IUH27	-
CR9EHVX9	IUH27	-
CR9EIA9	IU27D	-
CR9EIX	IU27	-
CR9EIX9	IU27	-
CR9EK	U27ETR	-
CR9EKB	IU27A	-
CR9EKPA	IU27A	-
CR9EVX	IU27	-
CR9HIX	IUF27A	-
CS1	W9LM-US	-
CS2	W20MR-U	-
CS3	W20S-U	-
CS4	W14LM-U	-
CY03	DG-300	-
CY51	DG-307	-
CY52	DG-304	-
CY55	DG-306	-
CY57	DG-301	-
CZ258	DG-605	-
CZ71	DG-605	-
D10E	X31ES-U	-
D10EA	X31ESR-U	-
D10EV	IXU01-31	-
D5HS	X16FSR-U	-
D6EA	X20ESR-U	-
D6ES	X20ESR-U	-
D6HA	X20FSR-U	-
D6HS	X20FSR-U	-
D7EA	X22ESR-U	-
D7EV	IX22	-

NGK	DENSO	TT
D7EVX	IX22	-
D8EA	X24ESR-U	-
D8ES	X27ESR-U	-
D8ESL	X24ESR-U	-
D8EV	IX24	-
D8EVX	IX24	-
D8HA	X24FS-U	-
D8HS	X24FS-U	-
D9EA	X27ESR-U	-
D9ES	X27ESR-U	-
D9EV	IX27	-
D9EVX	IX27	-
DCP6E	XU20EPR-U	-
DCP7EVX	IXU22	-
DCP8E	XU24EPR-U	-
DCP8EVX	IXU24	-
DCPR6E	XU20EPR-U	-
DCPR6EIX	IXU22	-
DCPR6ES	XU20EPR-U	-
DCPR7E	XU22EPR-U	XU22TT
DCPR7EA9	XU22PR9	XU22TT
DCPR7EGP	IXU22	-
DCPR7EIX	IXU22	-
DCPR7EIXP	VXU22	-
DCPR7EN	XU22EPR-U	XU22TT
DCPR7E-N-10	XU22EPR-U	XU22TT
DCPR7ES	XU22EPR-U	XU22TT
DCPR7EVX	IXU22	-
DCPR8E	XU24EPR-U	-
DCPR8EIX	IXU24	-
DCPR8EKC	XU24EPR-U	-
DCPR8EKP	VXU24	-
DCPR8EN	XU24EPR-U	-
DCPR8EVX	IXU24	-
DCPR9E	XU27EPR-U	-
DCPR9EIX	IXU27	-
DCPR9EVX	IXU27	-
DCR7EIX	IXU22	-
DCR8EIX	IXU24	-
DCR9EIX	IXU27	-
DF5A11A	VFK16	IK16TT
DF5B11A	VFK16	IK16TT
DF6H11A	FXE20HE11	IXEH20ETT
DF6H11B	FXE20HR11	IXEH20TT
DF7H-11B	VFXEH22	IXEH22TT
DF8H-11B	FXE24HR11	-
DFH6B-11A	FK20HBR11	IKBH20TT
DIFR5C11	VFK16	IK16TT
DIFR6A13G	DK20PR-D13	-
DIFR6C11	VFK20F	IK20TT
DIFR6D13	DK20PR-D13	-
DILFR5A11	VFKH16	IKH16TT
DILFR5A11D	VFKH16	IKH16TT
DILFR5E-11	VFKH16	IKH16TT
DILFR6D11	FK20HR11	IKH20TT
DILFR6F11G	VFKH20	IKH20TT
DILFR6J11	VFKH20	IKH20TT
DILKAR6A11	FXE20HR11	IXEH20TT
DILKAR7B11	VFXEH22	IXEH22TT
DILKAR7F8	VFXEH22	IXEH22TT
DILKAR7G11GS	DXE22HQR-D11S	-
DILKR6D11G	IXUH20I	-
DILZKAR6A11	FXE20HE11	IXEH20ETT
DILZKR7A11G	DXU22HCR-D11S	-
DILZKR7A11GS	DXU22HCR-D11S	-
DILZKR7B11GS	DXU22HCR-D11S	-
DIMR8A10	IU24	-
DP1	DG-001	-
DP10	DG-003	-
DP11	DG-117	-
DP12	DG-112	-

NGK	DENSO	TT
DP13	DG-174	-
DP14	DG-118	-
DP15	DG-006	-
DP16	DG-106	-
DP17	DG-101	-
DP18	DG-005	-
DP19	DG-009	-
DP2	DG-012	-
DP20	DG-109	-
DP21	DG-301	-
DP22	DG-101	-
DP23	DG-004	-
DP24	DG-116	-
DP25	DG-012	-
DP26	DG-127	-
DP27	DG-121	-
DP28	DG-124	-
DP29	DG-102	-
DP3	DG-004	-
DP30	DG-119	-
DP31	DG-144	-
DP32	DG-145	-
DP33	DG-004	-
DP34	DG-115	-
DP35	DG-130	-
DP36	DG-122	-
DP37	DG-142	-
DP38	DG-155	-
DP39	DG-146	-
DP4	DG-005	-
DP40	DG-113	-
DP41	DG-110	-
DP42	DG-302	-
DP43	DG-129	-
DP44	DG-245	-
DP45	DG-240	-
DP46	DG-184	-
DP47	DG-178	-
DP48	DG-190	-
DP49	DG-193	-
DP5	DG-007	-
DP50	DG-177	-
DP51	DG-194	-
DP56	DG-181	-
DP57	DG-193	-
DP59	DG-187	-
DP5EA9	X16EPR-U9	-
DP6	DG-010	-
DP60	DG-300	-
DP61	DG-197	-
DP62	DG-171	-
DP63	DG-305	-
DP64	DG-195	-
DP65	DG-600	-
DP66	DG-126	-
DP6EA9	X20EPR-U9	-
DP7	DG-008	-
DP70	DG-196	-
DP71	DG-176	-
DP72	DG-621	-
DP73	DG-180	-
DP74	DG-610	-
DP77	DG-609	-
DP7EA9	X22EPR-U9	-
DP7EV9	IX22B	-
DP8	DG-300	-
DP8EA9	X24EPR-U9	-
DP8EV9	IX24B	-
DP8EVX9	IX24B	-
DP8Z	X24GPR-U	-
DP9	DG-003	-

NGK	DENSO	TT
DP9EA9	X27EPR-U9	-
DP9EV9	IX27B	-
DP9EVX9	IX27B	-
DP9Z	X27GPR-U	-
D-Power 1	DG-001	-
D-Power 2	DG-012	-
D-Power 4	DG-005	-
D-Power 5	DG-007	-
D-Power 6	DG-010	-
D-Power 7	DG-008	-
D-Power 8	DG-300	-
D-Power 9	DG-003	-
D-Power 1	DG-001	-
D-Power 10	DG-003	-
D-Power 11	DG-117	-
D-Power 12	DG-112	-
D-Power 13	DG-174	-
D-Power 14	DG-118	-
D-Power 15	DG-006	-
D-Power 16	DG-106	-
D-Power 17	DG-101	-
D-Power 18	DG-005	-
D-Power 19	DG-009	-
D-Power 20	DG-109	-
D-Power 21	DG-301	-
D-Power 22	DG-101	-
D-Power 23	DG-004	-
D-Power 24	DG-116	-
D-Power 25	DG-012	-
D-Power 26	DG-127	-
D-Power 27	DG-121	-
D-Power 28	DG-124	-
D-Power 29	DG-102	-
D-Power 3	DG-004	-
D-Power 30	DG-119	-
D-Power 31	DG-144	-
D-Power 32	DG-145	-
D-Power 33	DG-004	-
D-Power 34	DG-115	-
D-Power 35	DG-130	-
D-Power 36	DG-122	-
D-Power 37	DG-142	-
D-Power 38	DG-155	-
D-Power 39	DG-146	-
D-Power 40	DG-113	-
D-Power 41	DG-110	-
D-Power 42	DG-302	-
D-Power 43	DG-129	-
D-Power 44	DG-245	-
D-Power 45	DG-240	-
D-Power 46	DG-184	-
D-Power 47	DG-178	-
D-Power 48	DG-190	-
D-Power 49	DG-193	-
D-Power 5	DG-007	-
D-Power 50	DG-177	-
D-Power 51	DG-194	-
D-Power 56	DG-181	-
D-Power 57	DG-193	-
D-Power 59	DG-187	-
D-Power 60	DG-300	-
D-Power 61	DG-197	-
D-Power 62	DG-171	-
D-Power 63	DG-305	-
D-Power 64	DG-195	-
D-Power 65	DG-600	-
D-Power 66	DG-126	-
D-Power 70	DG-196	-
D-Power 71	DG-176	-
D-Power 72	DG-621	-
D-Power 73	DG-180	-

NGK	DENSO	TT
D-Power 74	DG-610	-
D-Power 77	DG-609	-
DPR5EA9	X16EPR-U9	-
DPR6EA9	X20EPR-U9	-
DPR6EB9	IX22B	-
DPR7EA9	X22EPR-U9	-
DPR7EIX9	IX22B	-
DPR7EV9	IX22B	-
DPR7EVX9	IX22B	-
DPR8EA-9	X24EPR-U9	-
DPR8EIX-9	IX24B	-
DPR8EV9	IX24B	-
DPR8EVX9	IX24B	-
DPR8Z	X24GPR-U	-
DPR8ZIX	IXG24	-
DPR9EA9	X27EPR-U9	-
DPR9EIX9	IX27B	-
DPR9EV9	IX27B	-
DPR9EVX9	IX27B	-
DPR9Z	X27GPR-U	-
DR4HS	X16FSR-U	-
DR5HS	X16FSR-U	-
DR6EA	X20ESR-U	-
DR6HS	X20FSR-U	-
DR7EA	X22ESR-U	-
DR7EB	X22ESR-U	-
DR7ES	X22ESR-U	-
DR8EA	X24ESR-U	-
DR8EB	X24ESR-U	-
DR8EIX	IX24	-
DR8ES	X27ESR-U	-
DR8ESL	X24ESR-U	-
DR8EVX	IX24	-
DR8HS	X24FS-U	-
DR9EA	X27ESR-U	-
DR9EIX	IX27	-
DR9ES	X27ESR-U	-
DR9EVX	IX27	-
ER10EH	Y31FER-C	-
ER8EH	Y24FER-C	-
ER8EHIX	IY24	-
ER8EHN	Y24FER-C	-
ER9EH	Y27FER-C	-
ER9EH-6N	Y27FER-C	-
ER9EHIX	IY27	-
FR4	K16PR-U	K16TT
FR45	K16PR-U11	K16TT
FR4BP11	IK16	IK16TT
FR5	K20PR-U	K20TT
FR5-1	KJ20CR-L11	K20TT
FR5AP-10	PK16PR11	K16TT
FR5AP-11	PK16PR11	K16TT
FR5BP11	IK16	IK16TT
FR5CP	IK16	IK16TT
FR5EI	K16PSR-B8	IK16TT
FR6BP11	IK20	IK20TT
FR6EI	K20PSR-B8	IK20TT
FR7AID	IK22	-
FR7AP10	IK22	-
FR7B11	IK22	-
FR8B11	IK24C11	-
FR9B11	IK27C11	-
GR4	W14EXR-U	IW16TT
GR45	W14EXR-U11	IW16TT
GR4IX	IW16	IW16TT
GR5	W16EXR-U	W16TT
GR55	W16EXR-U13	W16TT
GR5AI10	IW16	IW16TT
GR5IX	IW16	IW16TT
GR5VX	IW16	IW16TT
GR6AI10	IW20	IW20TT

Spark & Glow Plugs

Cross Reference Chart - Competitor

NGK	DENSO	TT
HAMPFR5C111G	IK16	IK16TT
HAMPFR6C111G	IK20	IK20TT
HAMPFR6D111G	IQ20	IQ20TT
HAMPZFR5F111G	IK16	IK16TT
HAMPZFR6F111G	IK20	IK20TT
HAMPZFR6K111G	IK20	IK20TT
HB6AIX-11P	VKA20	-
HB6BIX-11P	VKB20	-
IFR5A11	SK16R11	IK16TT
IFR5A8N	SK16R-P8	IK16TT
IFR5D10	VK16	IK16TT
IFR5E11	SK16PR-A11	IK16TT
IFR5E13	SK16PR-E11	IK16TT
IFR5G11	SK16PR-L11	IK16TT
IFR5G11K	SK16PR-L11	IK16TT
IFR5J11	SK16PR-A11	IK16TT
IFR5L11	VK16PRZ11	IK16TT
IFR5N	VK16	IK16TT
IFR5N10	SK16PR-A11	IK16TT
IFR5T11	SK16R11	IK16TT
IFR5T8N	SK16R-P8	IK16TT
IFR6A11	SK20R11	IK20TT
IFR6A11T	SK20BR11	-
IFR6B	VK20Y	-
IFR6B11	SK20PR-A11	IK20TT
IFR6BK	VK20Y	-
IFR6C	SK20PR-L9	IK20TT
IFR6CS	VK20G	-
IFR6D10	SK20PR-L9	IK20TT
IFR6E11	SK20PR-A11	IK20TT
IFR6G11K	SK20PR-L11	IK20TT
IFR6J	VK20Y	-
IFR6J11	VK20	IK20TT
IFR6L11	VK20PRZ11	IK20TT
IFR6Q-G	VK20Y	-
IFR6QS	VK20G	-
IFR6S	SK20PR-A8	IK20TT
IFR6T11	SK20R11	IK20TT
IFR6W-7G	VK20Y	-
IFR6Z7G	VK20Y	-
IFR7F6D	IK22	-
IFR7F8D	VK22	-
IFR7F8J	VK22	-
IFR7FD	VK22	-
IFR7FJ8	IK22	-
IFR7G-11K	SK22PR-M11	-
IFR7G-11KS	SK22PR-M11S	-
IFR7L11	VK22PRZ11	-
IFR7U	VK22	-
IFR7U-4D	VK22	-
IFR7X8G	VK22	-
IFR8H11	VK24PRZ11	-
IFR8L11	VK24PRZ11	-
IFR9H11	VK27PRZ11	-
IFR9L11	VK27PRZ11	-
IGR5B10D	VW16	IW16TT
IGR6A	VW20T	IW20TT
IGR6A-11	VW20	IW20TT
IGR6B-10D	VW20T	IW20TT
IGR7A	S22PR-A7	-
IGR7A-G	S22PR-A7	-
IGR7B-10D	S22PR-A7	-
IJR7A	VX22BC	-
IJR7A9	VX22BC	-
IJR8B9	IX24B	-
IKR6G11	ZXU20PR11	-
IKR7A	VXU22	-
IKR7B	VXU22	-
IKR7C	SXU22PR9	-
IKR7D	SXU22PR9	-
IKR7E9	VXU22	-

NGK	DENSO	TT
IKR9F8	IXU27	-
IKR9J8	IXU27	-
ILFR5B11	VKH16	IKH16TT
ILFR5C11	SK16HR11	IKH16TT
ILFR5-T11	SK16HR11	IKH16TT
ILFR6A	VKH20	IKH20TT
ILFR6B	VKH20Y	-
ILFR6C	VKH20	IKH20TT
ILFR6C11	SK20HR11	IKH20TT
ILFR6D11	FK20HR11	IKH20TT
ILFR6G	VKH20	IKH20TT
ILFR6J-11K	VKH20	IKH20TT
ILFR6K-8	VKH20Y	-
ILFR6T-11	SK20HR11	IKH20TT
ILFR7B-8	VKH22	-
ILFR7FD	VKH22	-
ILFR7H	VKH22	-
ILKAR6C-10	VFXEH20	IXEH20TT
ILKAR6F11	SXU20HPR11	-
ILKAR7B11	SC20HR11	IXEH22TT
ILKAR7L11	VCH20	IXEH22TT
ILKR6F11	VXUH20I	-
ILKR7A-11T	ZXU22HBR11	-
ILKR7B-8	SXU22HDR8	-
ILKR7C-9	VXUH22I	-
ILKR7D-9	VXUH22I	-
ILKR7E-6	IXUH22	-
ILTR5A-13G	ITV16	ITV16TT
ILTR5B11	ITL16	ITL16TT
ILTR5C11	ITL16	ITL16TT
ILTR5D	ITV16	ITV16TT
ILTR5E11	ITV16	ITV16TT
ILTR6A-13G	ITV20	ITV20TT
ILTR6A-8G	ITV22	-
ILTR6B11	ITL20	-
ILTR6E11	ITV20	ITV20TT
ILTR6G8G	ITV22	-
ILTR6H8G	ITV22	-
ILZFR5B	VKH16	IKH16TT
ILZFR6A11	VKH20	IKH20TT
ILZFR6B	VKH20	IKH20TT
ILZFR6C-11K	VKH20	IKH20TT
ILZFR6CK	VKH20	IKH20TT
ILZFR6D11	VKH20	IKH20TT
ILZKAR7A	VFXEH22	IXEH22TT
ILZKAR7A10	VFXEH22	IXEH22TT
ILZKAR7B11	VFXEH22	IXEH22TT
ILZKBR7A8G	VXUH22	-
ILZKR7A	VXUHC22G	-
ILZKR7B11GS	VXUHC22G	-
ILZKR7B-11S	SXU22HCR11S	-
IMR8A-9H	IUH24D	-
IMR8B-9H	VNH24Z	-
IMR8C-9H	VUH24D	-
IMR9A-9H	IUH27D	-
IMR9B-9H	VNH27Z	-
IMR9C-9H	VUH27D	-
IMR9C-9HE	VUH27D	-
IMR9C-9HES	VUH27ES	-
IMR9E-9HES	VUH27ES	-
IRIMAC8	IXU24	-
IRIMAC9	IXU27	-
IRITOP 7	IQ22	-
IRITOP 8	IQ24	-
IRITOP 9	IQ27	-
IRIWAY 7	IK22	-
IRIWAY 8	IK24	-
IRIWAY 9	IK27	-
ITR4A15	VT16	IT16TT
ITR5F13	VT16	IT16TT
ITR6F13	ZT20EPR11	T20TT

NGK	DENSO	TT
IZFR5B	VKB16	-
IZFR5C	VKA16	-
IZFR5F11	SKJ16CR-L11	IK16TT
IZFR5K11	SKJ16DR-M11	IK16TT
IZFR5L11	SKJ16CR-L11	IK16TT
IZFR6B	VKB20	-
IZFR6F11	VKJ20RZ-M11	-
IZFR6H11	VK20	IK20TT
IZFR6K11	SKJ20DR-M11	IK20TT
IZFR6K11E	VK20G	-
IZFR6K11NS	SKJ20DR-M11S	-
IZFR6K-11S	SKJ20DR-M11S	-
IZFR6K13	SKJ20DR-M13	IK20TT
IZKR6B-10E	IXU22	-
IZKR7A	IXU22	-
J10A	X31ETR	-
J10B	X31ETR	-
J9A	X27ETR	-
J9B	X27ETR	-
JR10A	X31ETR	-
JR10B	X31ETR	-
JR10C	X31ETR	-
JR8B	IX24	-
JR8C	IX24	-
JR9A	X27ETR	-
JR9B	X27ETR	-
JR9C	X27ETR	-
KR6A10	XU20EPR-U	-
KR7AI	IXU22	-
KR8AI	IXU24	-
KR8BI	IXU24	-
KR9CI	IXU27	-
L8A	U24FSR-U	-
LFR4AP-11	IKH16	IKH16TT
LFR5A-11	K16HPR-U11	KH16TT
LFR5AIX-11	IKH16	IKH16TT
LFR5AIX-11P	VKH16	IKH16TT
LFR5AP-11	IKH16	IKH16TT
LFR5AQP	IKH16	IKH16TT
LFR5B	K16HPR-U11	KH16TT
LFR5BP-11	IKH16	IKH16TT
LFR5E-11	K16HR-U11	KH16TT
LFR5P11	IKH16	IKH16TT
LFR6A	K20HR-U11	KH20TT
LFR6A11	K20HR-U11	KH20TT
LFR6AIX11	IKH20	IKH20TT
LFR6AIX11P	VKH20	IKH20TT
LFR6AIXP	VKH20Y	-
LFR6AP11	IKH20	IKH20TT
LFR6AP9	IKH20	IKH20TT
LFR6AQP	IKH20	IKH20TT
LFR6B	K20HR-U11	KH20TT
LFR6BP-11	IKH20	IKH20TT
LFR6C	K20HR-U11	KH20TT
LFR6C-11	K16HR-U11	KH16TT
LFR6D	K20HR-U11	KH20TT
LFR7AIX	IKH22	-
LFR7AIXP	VKH22	-
LKAR6AIX13P	VFXEH20	IXEH20TT
LKR6C	XU20HR9	-
LKR6D-10E	XUH20TTi	XUH20TTi
LKR6D-E	XUH20TTi	XUH20TTi
LKR6E	XU20HR9	-
LKR7AI	IXUH22	-
LKR7AIX	IXUH22I	-
LKR7AIXP	VXUH22I	-
LKR7B	XU22HDR9	XUH22TT
LKR7B-9	XU22HDR9	XUH22TT
LKR7B18	IXU22HPR	-
LKR7BIXP	VXUH22	-
LKR7C	XU22HDR9	XUH22TT

NGK	DENSO	TT
LKR7E	XU22HDR9	XUH22TT
LL1	VK20T	IK20TT
LL2	VW20T	IW20TT
LL3	VQ20	IQ20TT
LL4	ITV16	ITV16TT
LL5	VT20	IT20TT
LL6	VK20	IK20TT
LL7	VKH20	IKH20TT
LL8	VXU22	-
LPG Laser Line 1	VK20T	IK20TT
LPG Laser Line 2	VW20T	IW20TT
LPG Laser Line 3	VQ20	IQ20TT
LPG Laser Line 4	ITV16	ITV16TT
LPG Laser Line 5	VT20	IT20TT
LPG Laser Line 6	VK20	IK20TT
LPG Laser Line 7	VKH20	IKH20TT
LPG Laser Line 8	VXU22	-
LPG1	VK20T	IK20TT
LPG2	VW20T	IW20TT
LPG3	VQ20	IQ20TT
LPG4	ITV16	ITV16TT
LPG5	VT20	IT20TT
LPG6	VK20	IK20TT
LPG7	VKH20	IKH20TT
LPG8	VXU22	-
LR8A	U24FSR-U	-
LR8B	IUF24	-
LTR5IX11	ITV16	ITV16TT
LTR6AP11	ITV20	ITV20TT
LTR6B-10T	ITV20	ITV20TT
LTR6IX11	ITV20	ITV20TT
LTR7IX11	ITV22	-
LZFR5BI-11	VKH16	IKH16TT
LZFR5C11	K16HPR-U11	KH16TT
LZFR5C11G	K16HPR-U11	KH16TT
LZFR6AI	IKH20	IKH20TT
LZFR6B10E	IKH20	IKH20TT
LZFR6BI-11	VKH20	IKH20TT
LZKAR6AP11	FXE20HR11	IXEH20TT
LZKAR7A	XE20HR-U9	IXEH20TT
LZKAR7B	XE20HR-U9	IXEH20TT
LZKR6AI-10G	IXUH22I	-
LZKR6B-10E	XU22HDR9	XUH22TT
LZKR6BE	IXUH22I	-
LZTR4A11	ITL16	ITL16TT
LZTR4AGP	ITL16	ITL16TT
LZTR4AIX13	ITL16	ITL16TT
LZTR5A11	ITL16	ITL16TT
LZTR5A13	ITL20	-
LZTR5AGP	ITL20	-
LZTR5AIX13	ITL20	-
LZTR6A11	ITL20	-
LZTR6AIX13	ITL20	-
PFR5A11	PQ16R	Q16TT
PFR5B	PK16R8	IK16TT
PFR5B-11	PK16PR-L11	IK16TT
PFR5B-11B	PK16R11	K16TT
PFR5B-11C	PK16R11	K16TT
PFR5B9	PK16R8	IK16TT
PFR5BD	PK16R8	IK16TT
PFR5C-11	PK16R11	K16TT
PFR5F-11	PQ16R	Q16TT
PFR5F-11A	PQ16R	Q16TT
PFR5G-11	PK16PR-L11	IK16TT
PFR5G-11E	PK16PR-L11	IK16TT
PFR5G-13E	PK16PR-L11	IK16TT
PFR5J11	PK16PR-P11	K16TT
PFR5K11	PQ16R	Q16TT
PFR5L11	PK16PR-L11	IK16TT
PFR5L13	VK16	IK16TT
PFR5N11	PK16PR-L11	IK16TT

Spark & Glow Plugs

Cross Reference Chart - Competitor

NGK	DENSO	TT
PFR5P	PK16R8	IK16TT
PFR5P11	PK16PR-L11	IK16TT
PFR5R11	PK16PR-L11	IK16TT
PFR6A	PQ20R	Q20TT
PFR6A-11	PQ20R	Q20TT
PFR6A-11A	PQ20R	Q20TT
PFR6B	PK20PR-P8	IK20TT
PFR6B-11	PK20PR11	K20TT
PFR6B-11B	PK20R11	K20TT
PFR6B-11C	PK20PR11	K20TT
PFR6B-9	PK20PR-P8	IK20TT
PFR6BD	PK20R8	IK20TT
PFR6C-11	PK20R11	K20TT
PFR6D10G	PK20PR-L11	IK20TT
PFR6E	PK20PR-P8	IK20TT
PFR6E-10	PK20PR11	K20TT
PFR6F-11A	VQ20	IQ20TT
PFR6G	PK20PR-P8	IK20TT
PFR6G-11	PK20PR11	K20TT
PFR6G-11	PK20PR-L11	IK20TT
PFR6G-11E	PK20PR-L11	IK20TT
PFR6G-13	PK20PR-L13	IK20TT
PFR6G-13E	PK20PR-L13	IK20TT
PFR6G-9	PK20PR-P8	IK20TT
PFR6H-10	PQ20R	Q20TT
PFR6J	PK20PR-P8	IK20TT
PFR6J-11	PK20PR-P11	K20TT
PFR6J-13	PK20PR-L13	IK20TT
PFR6K-11	PQ20R	Q20TT
PFR6L-11	PK20PR11	K20TT
PFR6L-13	PK20PR-L13	IK20TT
PFR6M	PK20PR-P8	IK20TT
PFR6N	SK20PR-L9	IK20TT
PFR6N-11	PK20PR-L11	IK20TT
PFR6P	PK20R8	IK20TT
PFR6P-11	PK20PR-L11	IK20TT
PFR6Q	PK20PR-P8	IK20TT
PFR6R-11	PK20PR-L11	IK20TT
PFR6T-10	PK20PR-L11	IK20TT
PFR6T-10G	PK20PR-L11	IK20TT
PFR6TG	PK20PR-P8	IK20TT
PFR6U-11G	PK20PR-L11	IK20TT
PFR6V-10D	VK20T	IK20TT
PFR6WT	VKB20	-
PFR6WTG	VKB20	-
PFR6X-11	PK20PR-L11	IK20TT
PFR7A-11	VQ22	-
PFR7AB	PK22PR8	-
PFR7B	PK22PR8	-
PFR7B-11	PK22PR11	-
PFR7B-4D	VK22	-
PFR7B-9	PK22PR8	-
PFR7BD	VK22	-
PFR7G	PK22PR8	-
PFR7G-11	PK22PR-L11S	-
PFR7G-11S	PK22PR-L11S	-
PFR7G-9	PK22PR8	-
PFR7H-10	PK22PR-L11S	-
PFR7M	PK22PR8	-
PFR7ND	PK22PR8	-
PFR7Q	PK22PR8	-
PFR7S8EG	PK22PR8	-
PFR7W-T	IK22	-
PFR7WTG	VK22	-
PFR7ZTG	VK22	-
PFR8B	IK24	-
PFR8B-9	IK24	-
PFR8S8EG	IK24	-
PGR5A	P16PR11	W16TT
PGR5A-11	P16PR11	W16TT
PGR5C-11	P16PR11	W16TT

NGK	DENSO	TT
PGR6A	P20PR11	W20TT
PGR6A-11	P20PR11	W20TT
PGR6AD	VW20T	IW20TT
PGR6B	P20PR11	W20TT
PGR6D	P20PR11	W20TT
PGR7A	P22PR8	-
PGR7A-11	P22PR8	-
PJ7A	IX22B	-
PJR7A	IX22B	-
PJR8A	IX24B	-
PKR7A	VXU22	-
PKR9B	IXU27	-
PKUR6EKPA	PK20PTR-S9	K20TT
PLFR4A-11	VKH16	IKH16TT
PLFR5A-11	VKH16	IKH16TT
PLFR5A-11D	VKH16	IKH16TT
PLFR5A-9	VKH16	IKH16TT
PLFR6A	VKH20Y	-
PLFR6A-11	VKH20	IKH20TT
PLFR6A-9	VKH20	IKH20TT
PLFR6B-10	VKH20	IKH20TT
PLFR6C-10G	IKH20	IKH20TT
PLFR7A-11	VKH22	-
PLFR7A-9	VKH22	-
PLKR6A	IXUH22	-
PLKR7A	SXU22HDR8	-
PLKR7B8E	VXUH22	-
PLTR6A10G	ITV20	ITV20TT
PLZFR5B13G	VKH16	IKH16TT
PLZFR6A-11S	VKH20	IKH20TT
PLZKAR6A-11	FXE20HR11	IXEH20TT
PLZKAR6A-11D	FXE20HR11	IXEH20TT
PLZKAR6AP-11	FXE20HR11	IXEH20TT
PLZKBR7A-G	VXUH22	-
PLZTR5A13	ITL16	ITL16TT
PMR7A	IU22	-
PMR8A	IU24	-
PMR8B	IU24	-
PMR8CH	IU24	-
PMR9B	IU27	-
PTR4B-15	PT16EPR-L13	IT16TT
PTR4G-15	PT16EPR-L13	IT16TT
PTR5A-10	PT16VR10	TV16TT
PTR5A-13	PT16VR13	TV16TT
PTR5C-13	PT16EPR-L13	IT16TT
PTR5D-10	PT16EPR-L13	IT16TT
PTR5D-13	PT16EPR-L13	IT16TT
PTR6D-13	ZT20EPR11	T20TT
PTR6D-13G	ZT20EPR11	T20TT
PTR6E-13	VT20	IT20TT
PTR6F-13	ZT20EPR11	T20TT
PZFR5B	VKB16	-
PZFR5C	VKA16	-
PZFR5D-11	PKJ16CR-L11	IK16TT
PZFR5E-11	SKJ16CR-L11	IK16TT
PZFR5F	PKJ16CR8	-
PZFR5F-11	SKJ16CR-L11	IK16TT
PZFR5F-13	PKJ16CR-L13	IK16TT
PZFR5J-11	SKJ16CR-L11	IK16TT
PZFR5N-11T	VKA16	-
PZFR5N-11TG	VKA16	-
PZFR5Q-11	SKJ16CR-L11	IK16TT
PZFR6B	PKJ20CR8	-
PZFR6D-11	VKA20	-
PZFR6E-11	PKJ20CR-L11	IK20TT
PZFR6F	PKJ20CR8	-
PZFR6F-11	PKJ20CR-L11	IK20TT
PZFR6F-8	PKJ20CR-L11	IK20TT
PZFR6J-11	PKJ20CR-L11	IK20TT
PZFR6N-11TG	SK20BGR11	-
PZFR6R	PKJ20CR8	-

NGK	DENSO	TT
PZFR6R8EG	SKJ20CR-A8	-
PZTR5A15	PT16EPR-L13	IT16TT
R0045J-10	RU01-31	-
R0045J-11	RU01-34	-
R0045J-9	RU01-27	-
R0045Q-10	RU01-31	-
R0045Q-11	RU01-34	-
R015-10	IU31	-
R015-8	IU27	-
R015-9	IU31	-
R016-10	IU01-31	-
R016-11	IU01-34	-
R0161-10	IUF31A	-
R0161-9	IUF27A	-
R016-8	IU01-24	-
R016-8.5	IU01-27	-
R016-9	IU01-27	-
R017-10	IU31A	-
R017-11	IU01-34	-
R017-7	U22ETR	-
R017-8	IU24A	-
R017-8.5	IU27	-
R017-9	IU27A	-
R017-S11	IU01-34	-
R018G-8	IU24	-
R0200G-10	RU01-31	-
R0200G-11	RU01-34	-
R0256B-10	IU01-31	-
R0256B-11	IU01-34	-
R0256R-10	IU01-31	-
R0256R-11	IU01-34	-
R0256R-9	IU01-27	-
R0310B-10	RU01-31	-
R0310B-11	RU01-34	-
R0373A-10	IU01-31	-
R0373A-11	IU01-34	-
R0373A-9	IU01-27	-
R0375A-10	IU01-31	-
R0379A-10	IU01-31	-
R0406A-8	IU01-24	-
R0406A-9	IU01-27	-
R0409B-10	IU01-31	-
R0409B-8	IU01-24	-
R0409B-9	IU01-27	-
R216-10	IXU01-31	-
R216-11	IXU01-34	-
R216-8	IXU01-24	-
R216-9	IXU01-27	-
R217-10	IXU01-31	-
R217-11	IXU01-34	-
R217-9	IX27	-
R218-10	IXU01-31	-
R218-9	IX27B	-
R2198-10P	IXU01-31	-
R2198-11P	IXU01-34	-
R2525-10	IXU01-31	-
R2525-11	IXU01-34	-
R2525-9	IXU01-27	-
R4118S-10	IW31	-
R4118S-10.5	IW01-32	-
R4118S-11	IW34	-
R4118S-7	IW22	-
R4118S-7.5	IW24	-
R4118S-8	IW24	-
R4118S-8.5	IW27	-
R4118S-9	IW27	-
R4118S-9.5	IW29	-
R4304A-10	IW31	-
R4304A-7	IW22	-
R4304A-8	IW24	-
R4304A-9	IW27	-

NGK	DENSO	TT
R4339-10	IW31	-
R4339-8	IW24	-
R4339-9	IW27	-
R4452D-10	IW31	-
R4452D-10.5	IW01-32	-
R4452D-11	IW34	-
R4452D-7	IW22	-
R4452D-7.5	IW24	-
R4452D-8	IW24	-
R4452D-8.5	IW24	-
R4452D-9	IW27	-
R4452D-9.5	IW29	-
R4468A-10.5	IRE01-32	-
R4468A-11	IRE01-34	-
R4630A-10	IW01-31	-
R4630A-10.5	IW01-32	-
R4630A-11	IW01-34	-
R4630A-8	IW01-24	-
R4630A-8.5	IW01-27	-
R4630A-9	IW01-27	-
R4630A-9.5	IW01-29	-
R4652-10	IW31	-
R4652-10.5	IW34	-
R4652-8	IW24	-
R4652-8.5	IW27	-
R4652-9	IW27	-
R4652-9.5	IW29	-
R5184-10	IWM01-31	-
R5184-10.5	IWM01-32	-
R5184-11	IWM01-34	-
R5184-9.5	IWM01-29	-
R5400.10	IQ31	-
R5400.7	IQ22	-
R5400-8	IQ24	-
R5400-9	IQ27	-
R5525-7	IWF22	-
R5525-8	IWF24	-
R5525-9	IWF27	-
R5530-8	IWF24	-
R5530-9	IWF27	-
R5540-10	IWM01-31	-
R5540F-11	IWM01-34	-
R5670-5	W16PR-U	-
R5670-6	W20PR-U	-
R5670-7	W22S-U	-
R5670-8	W24S-U	-
R5670-9	W27S-U	-
R5671-10	W31ESR-U	-
R5671-7	W22ESR-U	-
R5671-8	W24ESR-U	-
R5671-9	W27ESR-U	-
R5671A-10	IK31	-
R5671A-11	IK34	-
R5671A-7	IK22	-
R5671A-8	IK24	-
R5671A-9	IK27	-
R5672-8	IW24	-
R5672-9	IW27	-
R5672A-10	IK31	-
R5672A-8	IK24	-
R5672A-9	IK27	-
R5673-6	ITF20	ITF20TT
R5673-7	ITF22	-
R5673-8	ITF24	-
R5673-9	ITF27	-
R5674-6	ITF20	ITF20TT
R5674-7	ITF22	-
R5674-8	ITF24	-
R5674-9	ITF27	-
R5686-10	IQ31	-
R5686-11	IQ34	-

NGK	DENSO	TT
R5686-8	IQ24	-
R5686-9	IQ27	-
R5687-10	IQ02-31	-
R5687-8	IQ02-24	-
R5687-9	IQ02-27	-
R5724-8	IT24	-
R5724-9	IT27	-
R5796-10	IQ01-31	-
R5796-8	IQ01-24	-
R5796-9	IQ01-27	-
R5830-10	IQ01-31	-
R5830-11	IQ01-34	-
R5830-8	IQ01-24	-
R5830-9	IQ01-27	-
R6021E-10	IW31	-
R6021E-105	IW01-32	-
R6021E-11	IW34	-
R6021E-7	IW22	-
R6021E-8	IW24	-
R6021E-8.5	IW27	-
R6021E-9	IW27	-
R6021E-9.5	IW29	-
R6061-10	IW01-31	-
R6061-11	IW01-34	-
R6061-9	IW01-27	-
R6120-10	IA01-31	-
R6120-10.5	IAE01-32	-
R6120-11	IAE01-34	-
R6120A-10	IA01-31	-
R6120A-10.5	IA01-32	-
R6120A-11	IA01-34	-
R6120M-10	IA01-31	-
R6120M-10.5	IAE01-32	-
R6179A-10.5P	IWM01-32	-
R6179A-10P	IWM01-31	-
R6179A-11P	IWM01-34	-
R6179C-10.5P	IA01-32	-
R6198C-9	IW01-27	-
R6205-10	IK31	-
R6206-10	IK02-31	-
R6206-8	IK02-24	-
R6206-9	IK02-27	-
R6241-10	IK31	-
R6241-8	IK01-24	-
R6241-9	IK01-27	-
R6242-10	IK02-31	-
R6242-8	IK02-24	-
R6242-9	IK02-27	-
R6252E-10	IW01-31	-
R6252E-10.5	IW01-32	-
R6252E-9	IW01-27	-
R6252E-9.5	IW01-29	-
R6252K-10.5	IW01-32	-
R6254E-10.5	IW01-32	-
R6254E-8	IW01-24	-
R6254E-9	IW01-27	-
R6254K-10.5	IW01-32	-
R6255-10	IK31	-
R6255-7	IK22	-
R6255-8	IK24	-
R6255-9	IK27	-
R6255F-10	IK31	-
R6255F-7	IK22	-
R6255F-8	IK24	-
R6255F-9	IK27	-
R6326-10	IK31	-
R6326-7	IK22	-
R6326-8	IK24	-
R6326-9	IK27	-
R6337-10	IQ31	-
R6337-7	IQ22	-

NGK	DENSO	TT
R6337-8	IQ24	-
R6337-9	IQ27	-
R6385-105P	IW01-32	-
R6385-10P	IW01-31	-
R6385-11P	IW01-34	-
R6385-7.5P	IW01-24	-
R6385-8P	IW01-24	-
R6385-9.5P	IW01-29	-
R6385-9P	IW01-27	-
R6385A-10.5P	IW01-32	-
R6427-10	IK31	-
R6427-7	IK22	-
R6427-8	IK24	-
R6427-9	IK27	-
R6701-7	IQ22	-
R6701-8	IQ24	-
R6702-10	IQ01-31	-
R6702-9	IQ01-27	-
R6725-10	IRE01-31	-
R6725-10.5	IRE01-32	-
R6725-11	IRE01-34	-
R6725-9	IRE01-27	-
R6758-7	IK22	-
R6758-8	IK24	-
R6759-10	IK01-31	-
R6759-9	IK01-27	-
R6794-10	IRE01-31	-
R6794-11	IRE01-34	-
R6794-9	IRE01-27	-
R6809-9	IK27	-
R6850-8	IW01-24	-
R6850-9	IW01-27	-
R6888A-10	IK01-31	-
R6888A-8	W27EBR	-
R6888A-9	W27EBR	-
R6918B-10	IW01-31	-
R6918B-11	IW01-34	-
R6918B-8	IW01-24	-
R6918B-9	IW01-27	-
R6918C-9	IW01-27	-
R7112-10	IK31	-
R7112-11	IK34	-
R7112-7	IK22	-
R7112-8	IK24	-
R7112-9	IK27	-
R7113-10	IK31	-
R7113-7	IK22	-
R7113-8	IK24	-
R7113-9	IK27	-
R7114-10	IK31	-
R7114-8	IK24	-
R7114-9	IK27	-
R7115-10	IK31	-
R7115-8	IK24	-
R7115-9	IK27	-
R7116-10	IK01-31	-
R7116-8	IK01-24	-
R7116-9	IK01-27	-
R7117-10	IK01-31	-
R7117-11	IK01-34	-
R7117-8	IK01-24	-
R7117-9	IK01-27	-
R7118-10	IK02-31	-
R7118-8	IK02-24	-
R7118-9	IK02-27	-
R7119-10	IK02-31	-
R7119-8	IK02-24	-
R7119-9	IK02-27	-
R7232-10	IQ31	-
R7232-11	IQ34	-
R7232-7	IQ22	-

NGK	DENSO	TT
R7232-8	IQ24	-
R7232-9	IQ27	-
R7233-10	IQ31	-
R7233-7	IQ22	-
R7233-8	IQ24	-
R7233-9	IQ27	-
R7234-10	IQ31	-
R7234-11	IQ34	-
R7234-8	IQ24	-
R7234-9	IQ27	-
R7235-10	IQ31	-
R7235-8	IQ24	-
R7235-9	IQ27	-
R7236-10	IQ01-31	-
R7236-11	IQ01-34	-
R7236-8	IQ01-24	-
R7236-9	IQ01-27	-
R7237-10	IQ01-31	-
R7237-8	IQ01-24	-
R7237-9	IQ01-27	-
R7238-10	IQ02-31	-
R7238-8	IQ02-24	-
R7238-9	IQ02-27	-
R7239-10	IQ02-31	-
R7239-8	IQ02-24	-
R7239-9	IQ02-27	-
R7279-10	IK02-31	-
R7282-10	IA01-31	-
R7282-10.5	IA01-32	-
R7282-11	IA01-34	-
R7282A-10	IA01-31	-
R7282A-10.5	IA01-32	-
R7282A-11	IA01-34	-
R7282C-10.5	IAE01-32	-
R7282C-11	IAE01-34	-
R7345-8	IKH24	-
R7345-9	IKH27	-
R7346-10	IK01-31	-
R7346-8	IK01-24	-
R7346-9	IK01-27	-
R7376-10	IW01-31	-
R7376-8	IW01-24	-
R7376-9	IW01-27	-
R7420-10	IRE01-31	-
R7420-10.5	IRE01-32	-
R7420-11	IRE01-34	-
R7420-9	IRE01-27	-
R7420T-10	IRE01-31	-
R7420T-11	IRE01-34	-
R7420T-9	IRE01-27	-
R7433-10	IK31	-
R7433-8	IK24	-
R7433-9	IK27	-
R7434-10	IK01-31	-
R7434-8	IK01-24	-
R7434-9	IK01-27	-
R7435-10	IQ31	-
R7435-8	IQ24	-
R7435-9	IQ27	-
R7436-10	IQ01-31	-
R7436-8	IQ01-24	-
R7436-9	IQ01-27	-
R7437-8	IKH24	-
R7437-9	IKH27	-
R7438-10	IKH01-31	-
R7438-8	IKH01-24	-
R7438-9	IKH01-27	-
R7440A-10L	IRL01-31	-
R7440A-9L	IRL01-27	-
R7440B-10T	IRT01-31	-
R7440B-11T	IRT01-34	-

NGK	DENSO	TT
RE7AL	IRL01-27	-
RE7CL	IRL01-27	-
RE8AL	IRL01-27	-
RE9BT	IRT01-31	-
SD10	IRE01-31	-
SD11A	S-31A	-
SD9	IRE01-27	-
SD9A	IRE01-27	-
SIFR6A11	VK20	IK20TT
SILFR6A	VKH20Y	-
SILFR6A11	VKH20	IKH20TT
SILFR6A6	VKH20Y	-
SILFR6B8	VKH20Y	-
SILFR6C11	VKH20	IKH20TT
SILTR6A7G	ITV22	-
SILZKAR7B11	VFXEH22	IXEH22TT
SILZKR6B10E	VXUH20I	-
SILZKR6B-11	VXUH20I	-
SILZKR7AS	VXUH22I	-
SILZKR7B11	VXUH22I	-
SILZKR7C11S	SXU22HCR11S	-
SIMR8A9	IJU24	-
SIZFR6B8EG	SKJ20CR-A8	-
SR5	T20NR-U11	IT20TT
T7340T6	IK20	IK20TT
T7340T7	IK22	-
T7340T8	IK24	-
T7340T9	IK27	-
T7341T6	IQ20	IQ20TT
T7341T7	IQ22	-
T7341T8	IQ24	-
T7341T9	IQ27	-
T7418T10	IK01-31	-
T7418T8	IK01-24	-
T7418T9	IK01-27	-
T7419T10	IQ01-31	-
T7419T8	IQ01-24	-
T7419T9	IQ01-27	-
TR4	T16EPR-U	T16TT
TR42	T16EPR-U	T16TT
TR4X	IT16	IT16TT
TR4VX	IT16	IT16TT
TR5	T20EPR-U	T20TT
TR51	T20EPR-U	T20TT
TR51IX	IT20	IT20TT
TR51VX	IT20	IT20TT
TR55	T20EPR-U15	T20TT
TR551	T16EPR-U15	T16TT
TR551IX	IT16	IT16TT
TR551VX	IT20	IT20TT
TR55IX	IT20	IT20TT
TR55VX	IT20	IT20TT
TR5A-10	T16VR-U10	TV16TT
TR5A13	T16VR-U10	TV16TT
TR5AI-13	VT16	IT16TT
TR5B13	T16VR-U10	TV16TT
TR5B-13	T16VR-U10	TV16TT
TR5BP12	VT16	IT16TT
TR5IX	IT20	IT20TT
TR5VX	IT20	IT20TT
TR6	T20EPR-U	T20TT
TR6AP13	ZT20EPR11	T20TT
TR6AP13E	IT20	IT20TT
TR6GP	IT20	IT20TT
TR6IX	IT20	IT20TT
TR7IX	IT22	-
TR8IX	IT24	-
UR4	T16PR-U	ITF16TT
UR40	T16PR-U15	ITF16TT
UR45	T16PR-U15	ITF16TT
UR45IX	ITF16	ITF16TT

NGK	DENSO	TT
UR45VX	ITF16	ITF16TT
UR4IX	ITF16	ITF16TT
UR4VX	ITF16	ITF16TT
UR5	T20PR-U	ITF20TT
UR55	T20PR-U15	ITF20TT
UR55IX	ITF20	ITF20TT
UR55VX	ITF20	ITF20TT
UR5IX	ITF20	ITF20TT
UR5VX	ITF20	ITF20TT
UR6	ITF20	ITF20TT
UR6IX	ITF20	ITF20TT
UR6VX	ITF20	ITF20TT
VL1	W20EPBR-S	W20TT
VL10	W20EXR-U11	W20TT
VL11	Q20PR-U11	Q20TT
VL12	Q20PR-U	Q20TT
VL13	W20EPR-U11	W20TT
VL14	K20PR-U11	K20TT
VL15	J16CR-U	W16TT
VL16	Q16PR-U11	Q16TT
VL17	Q20PR-U	Q20TT
VL18	W20FPR-U	WF20TT
VL19	W22EPR-U	W22TT
VL2	W20EPR-U	W20TT
VL20	K20TXR	K20TT
VL21	W20EPBR-S	W20TT
VL22	W20EPBR-S	W20TT
VL23	K20TXR	K20TT
VL24	K20PBR-S10	K20TT
VL25	PT16VR13	TV16TT
VL26	K20TNR	K20TT
VL27	K20PBR-S10	K20TT
VL28	K20PR-U	K20TT
VL29	K16TNR-S9	K16TT
VL3	W20FPR-U	WF20TT
VL30	K20TXR	K20TT
VL31	PT16EPR-L13	IT16TT
VL32	Q16PR-U	Q16TT
VL33	K16PR-U11	K16TT
VL34	PKJ16CR-L11	IK16TT
VL35	K16PR-U	K16TT
VL36	K16PR-U	K16TT
VL37	PK20PR-P8	IK20TT
VL38	K20PR-U	K20TT
VL39	K16R-U11	K16TT
VL4	W20EP-U	W20TT
VL40	KJ16CR-U11	K16TT
VL41	KJ16CR-U11	K16TT
VL42	XU22EPR-U	XU22TT
VL43	XU22EPR-U	XU22TT
VL44	KJ20DR-M11	IK20TT
VL45	T16VR-U10	TV16TT
VL5	T20EPR-U	T20TT
VL6	W16EPR-U	W16TT
VL7	T20EPR-U	T20TT
VL8	W16EPR-U	W16TT
VL9	W16EXR-U	W16TT
V-Line 1	W20EPBR-S	W20TT
V-Line 10	W20EXR-U11	W20TT
V-Line 11	Q20PR-U11	Q20TT
V-Line 12	Q20PR-U	Q20TT
V-Line 13	W20EPR-U11	W20TT
V-Line 14	K20PR-U11	K20TT
V-Line 15	J16CR-U	W16TT
V-Line 16	Q16PR-U11	Q16TT
V-Line 17	Q20PR-U	Q20TT
V-Line 18	W20FPR-U	WF20TT
V-Line 19	W22EPR-U	W22TT
V-line 2	W20EPR-U	W20TT
V-Line 20	K20TXR	K20TT
V-Line 21	W20EPBR-S	W20TT

NGK	DENSO	TT
V-Line 22	W20EPBR-S	W20TT
V-Line 23	K20TXR	K20TT
V-Line 24	K20PBR-S10	K20TT
V-Line 25	PT16VR13	TV16TT
V-Line 26	K20TNR	K20TT
V-Line 27	K20PBR-S10	K20TT
V-Line 28	K20PR-U	K20TT
V-Line 29	K16TNR-S9	K16TT
V-line 3	W20FPR-U	WF20TT
V-Line 30	K20TXR	K20TT
V-Line 31	PT16EPR-L13	IT16TT
V-Line 32	Q16PR-U	Q16TT
V-Line 33	K16PR-U11	K16TT
V-Line 34	PKJ16CR-L11	IK16TT
V-Line 35	K16PR-U	K16TT
V-Line 36	K16PR-U	K16TT
V-Line 37	PK20PR-P8	IK20TT
V-Line 38	K20PR-U	K20TT
V-Line 39	K16R-U11	K16TT
V-line 4	W20EP-U	W20TT
V-Line 40	KJ16CR-U11	K16TT
V-Line 41	KJ16CR-U11	K16TT
V-Line 42	XU22EPR-U	XU22TT
V-Line 43	XU22EPR-U	XU22TT
V-Line 44	KJ20DR-M11	IK20TT
V-Line 45	T16VR-U10	TV16TT
V-line 5	T20EPR-U	T20TT
V-Line 6	W16EPR-U	W16TT
V-Line 7	T20EPR-U	T20TT
V-Line 8	W16EPR-U	W16TT
V-Line 9	W16EXR-U	W16TT
WR41	MA9P-U	-
WR5	MA20PR-U	-
XR4	W16PR-U	-
XR40	W16PR-U	-
XR45	W16PR-U	-
XR5	W20PR-U	-
Y1002AS	DG-193	-
Y1005J	DG-181	-
Y1007J	DG-187	-
Y-1012J	DG-600	-
Y1013J	DG-305	-
Y-1030J	DG-196	-
Y-1031J	DG-176	-
Y-1035AS	DG-609	-
Y-1036AS	DG-619	-
Y1038J	DG-186	-
Y-107R	DG-114	-
Y-112M1	DG-157	-
Y-112R1	DG-157	-
Y-115R1	DG-162	-
Y-115T1	DG-198	-
Y-118R	DG-215	-
Y-118T1	DG-221	-
Y-128	DG-227	-
Y-128T	DG-234	-
Y-146R	DG-223	-
Y-147T	DG-232	-
Y-168R	DG-239	-
Y-176	DG-236	-
Y-178	DG-226	-
Y-178T	DG-235	-
Y-197R	DG-222	-
Y-197T	DG-233	-
Y-204TS1	DG-012	-
Y-207T	DG-012	-
Y-208T	DG-001	-
Y-306R	DG-143	-
Y-307R	DG-159	-
Y-501U	DG-144	-
Y-502R	DG-111	-

NGK	DENSO	TT
Y-503J	DG-003	-
Y-503R	DG-003	-
Y-504J	DG-116	-
Y-504R	DG-116	-
Y-506J	DG-008	-
Y-506R	DG-008	-
Y-507J	DG-145	-
Y-507R	DG-145	-
Y-508J	DG-189	-
Y-515J	DG-005	-
Y-516J	DG-112	-
Y-517J	DG-126	-
Y-519J	DG-197	-
Y-523J	DG-142	-
Y-524J	DG-121	-
Y-525J	DG-130	-
Y-527J	DG-602	-
Y-529J	DG-502	-
Y-530J	DG-137	-
Y-531J	DG-245	-
Y-532J	DG-214	-
Y-534J	DG-122	-
Y-541J	DG-302	-
Y-542J	DG-240	-
Y-543J	DG-184	-
Y-547AS	DG-178	-
Y-548J	DG-130	-
Y-603J	DG-300	-
Y-605J	DG-182	-
Y-607AS	DG-177	-
Y-609AS	DG-193	-
Y-701J	DG-146	-
Y-701R	DG-114	-
Y-702R	DG-157	-
Y-703R	DG-216	-
Y-705RS	DG-157	-
Y-707RS	DG-198	-
Y-710J	DG-124	-
Y-711J	DG-124	-
Y-712RS	DG-137	-
Y-715R	DG-211	-
Y-719RS1	DG-104	-
Y-721RS	DG-104	-
Y-722J	DG-172	-
Y-722JS	DG-172	-
Y-723U	DG-005	-
Y-729U	DG-115	-
Y-730U	DG-101	-
Y-731U	DG-003	-
Y-732J	DG-005	-
Y-732U	DG-005	-
Y-733J	DG-174	-
Y-738U	DG-161	-
Y-739R	DG-132	-
Y-740U	DG-101	-
Y-741U	DG-109	-
Y-742U	DG-124	-
Y-743U	DG-104	-
Y-745U	DG-117	-
Y-746J	DG-155	-
Y-746R	DG-155	-
Y-747U	DG-127	-
Y-748U	DG-118	-
Y-749J	DG-173	-
Y-755RS	DG-702	-
Y-8001AS	DG-603	-
Y-8002AS	DG-194	-
Y-8003J	DG-171	-
Y8005J	DG-195	-
Y-8008AS	DG-610	-
Y8009AS	DG-604	-

NGK	DENSO	TT
Y9001AS	DG-621	-
Y9003AS	DG-608	-
Y9004AS	DG-621	-
Y-902R	DG-001	-
Y-904M1	DG-108	-
Y-907R	DG-123	-
Y-908R	DG-001	-
Y-909R	DG-202	-
Y-910J	DG-004	-
Y-910R	DG-004	-
Y-911J	DG-004	-
Y-913J	DG-006	-
Y-913M	DG-006	-
Y-914U	DG-001	-
Y-916J	DG-010	-
Y-916R	DG-010	-
Y-917U	DG-001	-
Y-918J	DG-012	-
Y-918R	DG-012	-
Y-920R	DG-001	-
Y-922R	DG-001	-
Y-924J	DG-001	-
Y-925J	DG-106	-
Y-925R	DG-106	-
Y-927J	DG-009	-
Y-927R	DG-009	-
Y-928U	DG-102	-
Y-929U	DG-110	-
Y-930U	DG-119	-
Y-932R	DG-012	-
Y-933J	DG-012	-
Y-935U	DG-004	-
Y-937J	DG-007	-
Y-937R	DG-007	-
Y-938R	DG-001	-
Y-939J	DG-129	-
YE04	DG-113	-
YE05	DG-180	-
YE06	DG-171	-
YE07	DG-170	-
YE08	DG-614	-
YE12	DG-140	-
YE13	DG-606	-
YE14	DG-190	-
YR5	T20R-U	-
YR55	T20R-U	-
YR55IX	ITF20	ITF20TT
YR55VX	ITF20	ITF20TT
YR5IX	ITF20	ITF20TT
YR5VX	ITF20	ITF20TT
ZF4A-11	QJ16CR11	Q16TT
ZF5A-11	QJ16CR11	Q16TT
ZF5F11	KJ16CR11	K16TT
ZF6A11	QJ20CR11	Q20TT
ZFR4F11	KJ14CR11	-
ZFR5A-11	QJ16CR11	Q16TT
ZFR5AP	IK16	IK16TT
ZFR5C11G	KJ16CR-L11	K16TT
ZFR5D11	K16GPR-U11	-
ZFR5E11	K16GPR-U11	-
ZFR5F	KJ16CR11	K16TT
ZFR5F-11	KJ16CR-U11	K16TT
ZFR5FGP	IK16	IK16TT
ZFR5FIX11	IK16L	IK16TT
ZFR5FIX11P	PKJ16CR-L11	IK16TT
ZFR5FIX55	IK20	IK20TT
ZFR5J11	KJ16CR-L11	K16TT
ZFR5LP13G	IK16L	IK16TT
ZFR5N	KJ16CR-L11	K16TT
ZFR5N11	KJ16CR-L11	K16TT
ZFR5PG	KJ16CR-L11	K16TT

Spark & Glow Plugs

Cross Reference Chart - Competitor

NGK	DENSO	TT
ZFR5P-G	KJ16CR-L11	K16TT
ZFR5P-G	KJ16CR-U11	K16TT
ZFR6A11	QJ20CR11	Q20TT
ZFR6AGP	IQ20	IQ20TT
ZFR6BP-G	IK20L	IK20TT
ZFR6F-11	KJ20CR-U11	K20TT
ZFR6F11G	KJ20CR-L11	K20TT
ZFR6FGP	IK20	IK20TT
ZFR6FIX11	KJ20SR11	IK20TT
ZFR6FIX11P	IK20L	IK20TT
ZFR6FIX55	IK20	IK20TT
ZFR6J11	KJ20CR-L11	K20TT
ZFR6K11	KJ20DR-M11	IK20TT
ZFR6K-11E	KJ20DR-M11	IK20TT
ZFR6K11S	SKJ20DR-M11S	-
ZFR6K13	KJ20DR-M11	IK20TT
ZFR6KIX11PS	VK20G	-
ZFR6S-Q	K20PBR-S10	K20TT
ZFR6T-11G	KJ20DR-M11	IK20TT
ZFR6U11	KJ20CR-L11	K20TT
ZFR6V-G	KJ20CR-L11	K20TT
ZFR7A-11	KJ22CR-L11	-
ZFR7F	KJ22CR-L8	-
ZFR7F11	KJ22CR-L11	-
ZFR7F-11	KJ22CR-L11	-
ZFR7J11	KJ22CR-L11	-
ZG4A	J16CR-U	W16TT
ZG5A	J16CR-U	W16TT
ZG5E	J16CR-U	W16TT
ZGR4A	J16CR-U	W16TT
ZGR5A	J16CR-U	W16TT
ZGR5AGP	IW16	IW16TT
ZGR5C	J16CR-U	W16TT
ZGR5E	J16CR-U	W16TT
ZKR7A	XU22EPR-U	XU22TT
ZKR7A-10	XU22EPR-U	XU22TT
ZKR7A18	VXU22	-
ZMR7AP	IU22	-

NHSP	DENSO	TT
A7RTC	U20FSR-U	-
A7T	U22FSR-U	-
A7TC	U22FSR-U	-
B8RC	U24ESR-N	-
D6TC	X20FSR-U	-
D7	X22ESR-U	-
D8RTC	X24ESR-U	-
D8T	X24ESR-U	-
D8TC	X24ESR-U	-
DF7RECZ	XU22EPR-U	XU22TT
E5C	W14F-U	-
E5T	W14FPR-U	-
E6C	W20FSR-U	WF20TT
E6T	W14FPR-UL	-
E6TC	W20FPR-U	WF20TT
E7C	W20FSR-U	WF20TT
E7RTC	W20FPR-U	WF20TT
E7TC	W22FPR-U	-
E8C	W22FS-U	-
E8TC	W22FPR-U	-
F5C	W14E	-
F5T	W14EX-U	IW16TT
F5TC	W16EPR-U	W16TT
F6RTC	W16EXR-U11	W16TT
F6TC	W20EX-U	W20TT
F7RTC	W20EXR-U	W20TT
F7TC	W22EPR-U	W22TT
F7TJC	W20EPB	W20TT
F8C	W22ESR-U	-
F8TC	W22EPR-U	W22TT
G3F	W14PR-U	-

NHSP	DENSO	TT
G3TC	W14PR-U	-
G5RC	W20SR-U	-
G6	W20S-U	-
H5	W20S-U	-
K5RHCW	KJ16CR-L11	K16TT
K6RTC	K16PR-U11	K16TT
K6RTDC	K20TXR	K20TT
K6RTJC	K20PBR	K20TT
K6TC	Q16R-U	Q16TT
K6TJC	K20PBR	K20TT
K7RTC	K20PR-U11	K20TT
K7RTJC	K20PBR	K20TT
K7TC	Q20R-U	Q20TT
K7TJC	K20PBR	K20TT
L5T	W14MP-U10	-
L6T	W20MP-U	-
L7	W20M-US	-
L7T	W20MP-U	-
L7Y	W22M-U	-
L8RT	W22MPR-U	-
L9	W22M-U	-
L9T	W22MPR-U	-
N6	T20M-U	-
N9	T22M-U	-
Q7TC	T16EPR-U	T16TT
R4C	MW17	-
T5RTC	MA20PR-U	-

QUINTON HAZELL	DENSO	TT
QGP105	DG-012	-
QGP106	DG-202	-
QGP107	DG-001	-
QGP110	DG-001	-
QGP112	DG-012	-
QGP113	DG-202	-
QGP114	DG-123	-
QGP115	DG-001	-
QGP117	DG-198	-
QGP120	DG-114	-
QGP131	DG-012	-
QGP147	DG-004	-
QGP148	DG-010	-
QGP151	DG-001	-
QGP155	DG-005	-
QGP163	DG-124	-
QGP168	DG-198	-
QGP169	DG-104	-
QGP170	DG-157	-
QGP174	DG-115	-
QGP175	DG-003	-
QGP178	DG-007	-
QGP179	DG-101	-
QGP180	DG-133	-
QGP181	DG-012	-

RALLIART	DENSO	TT
RAY66001	VW22	-
RAY66002	IW24	-

RPOWER	DENSO	TT
RP4410	DG-202	-
RP4422	DG-012	-
RP4432	DG-123	-
RP4444	DG-001	-
RP4446	DG-132	-
RP4458	DG-006	-
RP4486	DG-004	-
RP4490	DG-010	-
RP6434	DG-224	-
RP6438	DG-227	-
RP6444	DG-236	-

RPOWER	DENSO	TT
RP6588	DG-235	-
RP6590	DG-226	-
RP6592	DG-234	-
RP6690	DG-225	-
RP6692	DG-212	-
RP6692	DG-218	-
RP6804	DG-215	-
RP6816	DG-175	-
RP6824	DG-143	-
RP6840	DG-223	-
RP6912	DG-114	-
RP6914	DG-222	-
RP6914	DG-238	-
RP6916	DG-233	-
RP8106	DG-108	-
RP8126	DG-231	-
RP8134	DG-159	-
RP8168	DG-157	-
RP8174	DG-198	-
RP8184	DG-239	-
RP8186	DG-221	-
RP8188	DG-214	-
RP8188	DG-232	-
RP8192	DG-213	-
RP8208	DG-216	-
RP8272	DG-005	-
RP8320	DG-119	-
RP8322	DG-124	-
RP8324	DG-104	-
RP8332	DG-211	-
RP8342	DG-110	-
RP8344	DG-102	-
RP8346	DG-115	-
RP8348	DG-137	-
RP8352	DG-003	-
RP8354	DG-009	-
RP8358	DG-106	-
RP8364	DG-146	-
RP8368	DG-133	-
RP8370	DG-109	-
RP8372	DG-127	-
RP8374	DG-117	-
RP8378	DG-219	-
RP8386	DG-311	-
RP8388	DG-007	-
RP8390	DG-101	-
RP8396	DG-008	-
RP8398	DG-161	-
RP8400	DG-118	-
RP8404	DG-144	-
RP8406	DG-155	-
RP8408	DG-111	-
RP8410	DG-116	-
RP8412	DG-126	-
RP8414	DG-172	-
RP8416	DG-604	-
RP8426	DG-605	-
RP8428	DG-602	-
RP8434	DG-502	-
RP8436	DG-180	-
RP8440	DG-606	-
RP8444	DG-608	-
RP8454	DG-609	-
RP8470	DG-610	-
RP8472	DG-603	-
RP8474	DG-607	-
RP8600	DG-307	-
RP8602	DG-304	-
RP8610	DG-305	-
RP8612	DG-306	-
RP8616	DG-121	-

RPOWER	DENSO	TT
RP8618	DG-130	-
RP8620	DG-112	-
RP8622	DG-122	-
RP8622/30	DG-196	-
RP8626	DG-145	-
RP8628	DG-129	-
RP8630	DG-139	-
RP8634	DG-184	-
RP8638	DG-142	-
RP8640	DG-173	-
RP8644	DG-240	-
RP8650	DG-140	-
RP8652	DG-113	-
RP8654	DG-182	-
RP8658	DG-186	-
RP8670	DG-302	-
RP8672	DG-195	-
RP8676	DG-183	-
RP8678	DG-171	-
RP8680	DG-300	-
RP8896	DG-174	-
RP8896	DG-301	-
RP8904	DG-187	-
RP8906	DG-217	-
RP8906	DG-245	-
RP8908	DG-188	-
RP8914	DG-170	-
RP8922	DG-601	-
RP8924	DG-194	-
RP8928	DG-193	-
RP8930	DG-181	-
RP8932	DG-176	-
RP8936	DG-197	-
RP8938	DG-189	-
RP9000	DG-177	-
RP9002	DG-190	-
RP9004	DG-178	-
RP9006	DG-191	-
RP9008	DG-192	-

SARD	DENSO	TT
SR20ISO	IK20	IK20TT
SR20JIS	IQ20	IQ20TT
SR22ISO	IK22	-
SR22JIS	IQ22	-
SR24ISO	IK24	-
SR24JIS	IQ24	-
SR27ISO	IK27	-
SR27JIS	IQ27	-
SR31ISO	IK31	-

SPLITFIRE	DENSO	TT
SF10B	T22EP-U	-
SF10C	T22EP-U	-
SF10D	T20EPR-U	T20TT
SF10D6	T20EPR-U	T20TT
SF10E6	T16EPR-U	T16TT
SF13C	ITF24	-
SF14E	T16PR-U	ITF16TT
SF254F	T16EPR-U	T16TT
SF259D	W24ESR-U	-
SF25E	W20MR-U	-
SF263D	W27FSR	-
SF265F	W16FSR	-
SF295F	T20M-U	-
SF29E	W14PR-U	-
SF2C	T20PR-U	ITF20TT
SF2D6	T20PR-U	ITF20TT
SF2E	T16PR-U	ITF16TT
SF30C	W20S-U	-
SF392A	K24PR-U11	-

Spark & Glow Plugs

Cross Reference Chart - Competitor

SPLITFIRE	DENSO	TT
SF392B	K22PR-U	-
SF392C	K20PR-U	K20TT
SF392D	K16PR-U	K16TT
SF392D6	K16PR-U	K16TT
SF405A	W31ESR-U	-
SF405B	IW27	-
SF405C	IW24	-
SF405D	W24ESR-U	-
SF405F	W22ESR-U	-
SF406A	IW31	-
SF406B	W27ESR-U	-
SF406C	W24ESR-U	-
SF409B	W24FSR	-
SF409C	W22FS-U	-
SF40D	W20ESR-U	-
SF412C	W20FPR-U	WF20TT
SF413B	X27ESR-U	-
SF415B	X27EPR-U9	-
SF415C	X24EPR-U9	-
SF416B	X27EPR-U9	-
SF416C	X24EPR-U9	-
SF416D	X22EPR-U9	-
SF419D	U20FSR-U	-
SF426C	W20EXR-U	W20TT
SF426E	W16EXR-U	W16TT
SF430B	U27ESR-N	-
SF430C	U24ESR-N	-
SF45F	W14LM-U	-
SF4E	MA16PR-U	-
SF512E	MA20PR-U	-
SF514D	T20EPR-U	T20TT
SF516D	T20EPR-U	T20TT
SF524E	T16EPR-U	T16TT
SF534D	ITV16	ITV16TT
SF550C	K20PR-U11	K20TT
SF6A	W24EPR-U	-
SF6C	W20EPR-U	W20TT
SF6D	W20EPR-U	W20TT
SF6E	W16EPR-U	W16TT
SF6F6	W14EXR-U11	IW16TT
SF8E	W16PR-U	-
SF98E	KJ20CR-L11	K20TT
TP10C	IT20	IT20TT
TP10D	IT16	IT16TT
TP2C	ITF22	-
TP2D	ITF20	ITF20TT
TP2E	ITF16	ITF16TT
TP392A	IK22	-
TP392B	IK22	-
TP392C	IK20	IK20TT
TP392D	IK16	IK16TT
TP405A	IW31	-
TP406B	IW27	-
TP406C	IW24	-
TP409B	IWF24	-
TP416B	IX27B	-
TP416C	IX24B	-
TP430B	U27ESR-N	-
TP522D	KJ20SR11	IK20TT
TP6A	IW24	-
TP6B	IW22	-
TP6C	IW20	IW20TT
TP6D	IW16	IW16TT

STITT	DENSO	TT
R407L	GN3-1A	-
R407XL	GE3-1	-
R807	GT3-1	-
RL807LL	GI3-1	-

TOM'S	DENSO	TT
10901TSP0106	IK20	IK20TT
10901TSP0107	IK22	-

TORCH	DENSO	TT
2197	X22ESR-U	-
2197C	X22ESR-U	-
4104JC	W14PR-U	-
4106JC	W20S-U	-
4135J	W14F-U	-
4136J	W16FSR	-
4195J	W16ESR-U	-
4197J	W22ESR-U	-
4198J	W24ESR-U	-
5580	W20EPB	W20TT
8012	IW20	IW20TT
A4106C	W20M-US	-
A6RC	U20FSR-U	-
A6RTC	U20FSR-U	-
A6TC	U20FSR-U	-
A7RC	U22FSR-U	-
A7RTC	U22FSR-U	-
A7TC	U22FSR-U	-
A8RTC	U24FSR-U	-
A8TC	U24FSR-U	-
B7R	U22ESR-N	-
B8R	U24ESR-N	-
B8RD	U24ETR	-
B9R	U27ESR-N	-
C6RTC	X20FSR-U	-
C6TC	X20FSR-U	-
C7ER	U20ESR-N	-
D6RTC9	X20EPR-U9	-
D7CA	X22ESR-U	-
D7RC	X22ESR-U	-
D7RTC	X22EPR-U9	-
D7RTC9	X22EPR-U9	-
D7TC	X22EPR-U9	-
D8C	X24ESR-U	-
D8RC	X24ESR-U	-
D8RTC	X24ESR-U	-
D8RTC9	X24EPR-U9	-
D8TC	X24ESR-U	-
DK7RTC	XU22EPR-U	XU22TT
DK7RTC9	XU22PR9	XU22TT
DK7RTPP	IXU22	-
E4RTC	W14FPR-UL	-
E4TC	W14FPR-UL	-
E5RTC	W16FPR-U	-
E5TC	W16FPR-U	-
E6C	W20FSR-U	WF20TT
E6RC	W20FSR-U	WF20TT
E6RCA	W20FR-L	WF20TT
E6RTC	W20FPR-U	WF20TT
E6TC	W20FPR-U	WF20TT
E7RC	W22FSR	-
E7RTC	W22FPR-U	-
E7TC	W22FPR-U	-
E8C	W24FSR	-
E8RC	W24FSR	-
E8RCA	W24FR-L	-
E8RTC	W24FPR	-
E8TC	W24FP-U	-
F5RF	W16EXR-U	W16TT
F5RTC	W16EXR-U	W16TT
F5TC	W16EPR-U	W16TT
F5TC11	W16EXR-U11	W16TT
F6C	W20ESR-U	-
F6RF	W20EXR-U	W20TT
F6RTC	W20EXR-U	W20TT
F6T	W20EX-U	W20TT
F6TC	W20EX-U	W20TT

TORCH	DENSO	TT
F7C	W22ESR-U	-
F7RC	W22ESR-U	-
F7RTC	W22EPR-U	W22TT
F7RTJC	W20EPB	W20TT
F7TC	W22EPR-U	W22TT
F7TJC	W20EPB	W20TT
F8C	W24ESR-U	-
F8RC	W24ESR-U	-
F8RTC	W24EPR-U	-
F8TC	W24EPR-U	-
F9C	W27ESR-U	-
G4C	W14PR-U	-
G4RC	W14PR-U	-
G6C	W20S-U	-
G6RC	W20SR-U	-
GL4	W14LM-U	-
GL4RC	W14LM-U	-
K4RTC3	KJ16CR-L11	K16TT
K5RF11	K16PR-U11	K16TT
K5RTC	Q16PR-U	Q16TT
K5RTC11	K16PR-U11	K16TT
K5TC	K16PR-U11	K16TT
K6RF	K20PR-U11	K20TT
K6RF11	K20PR-U11	K20TT
K6RTC	K16PR-U11	K16TT
K6RTC11	K20PR-U11	K20TT
K6RTC9	K20PR-U	K20TT
K6RTC-9	K20PR-U	K20TT
K6RTJC	K20PBR-S10	K20TT
K6TC	Q16R-U	Q16TT
K6TJC	K20PBR	K20TT
K7RF	K22PR-U	-
K7RTC	Q22PR-U	-
K7TC	Q20R-U	Q20TT
KR8TPP	IK24	-
L6	W20M-US	-
L6C	W20MR-U	-
L6RC	W20MR-U	-
L6RTC	W20MPR-U10	-
L6T	W20MP-U	-
L6TC	W20MP-U	-
L7	W20M-US	-
L7RTC	W22MPR-U	-
L7T	W20MP-U	-
L7TC	W22MPR-U	-
L9	W22M-U	-
L9T	W22MPR-U	-
N6C	T20M-U	-
N6RC	T20M-U	-
N6RTC	T20MP-U	-
N6TC	T20MP-U	-
N7C	T22M-U	-
N7RC	T22M-U	-
P5RTC	T16PR-U	ITF16TT
P5TC	T16PR-U	ITF16TT
P6RTC	T20PR-U	ITF20TT
P6TC	T20PR-U	ITF20TT
P7RTC	ITF22	-
P7TC	ITF22	-
PRA7HC	U22ESR-N	-
Q5RTC	T16EPR-U	T16TT
Q5TC	T16EPR-U	T16TT
Q6RTC	T20EPR-U	T20TT
Q6TC	T20EPR-U	T20TT
T1136	U20FSR-U	-
T1137	U22FSR-U	-
T1137C	U22FSR-U	-
T2138	X20FSR-U	-
T4135JC	W16FPR-U	-
T4136JC	W20FPR-U	WF20TT
T4137JC	W22FPR-U	-

TORCH	DENSO	TT
T4195J	W14EPR-U	IW16TT
T4196JC	W20EP-U	W20TT
T4197JC	W22EPR-U	W22TT
T5RTC	MA20PR-U	-
T5TC	MA16PR-U	-
T6RTC	MA20PR-U	-
T6TC	MA20P-U	-
T8RTC	MA20PR-U	-
T8TC	MA20P-U	-

TRUST	DENSO	TT
07	IQ22	-
07ISO	IK22	-
08	IQ24	-
08ISO	IK24	-
09	IQ01-27	-
09ISO	IK01-27	-
10	IQ01-31	-
10ISO	IK01-31	-
IT06ISO	IK20	IK20TT
IT06JIS	IQ20	IQ20TT
IT07ISO	IK22	-
IT07JIS	IQ22	-
IT07L	IKH22	-
IT08ISO	IK24	-
IT08JIS	IQ24	-
IT08L	IKH24	-
IT09ISO	IK27	-
IT09JIS	IQ27	-
RE09	IRE01-27	-
RE10	IRE01-31	-
RE11	IRE01-34	-
RE9	IRE01-27	-
RP08	IQ01-24	-
RP08ISO	IK01-24	-
RP09	IQ01-27	-
RP09ISO	IK01-27	-
RP10	IQ01-31	-
RP10ISO	IK01-31	-

UNIPART	DENSO	TT
ERR3799	W16EPR-U	W16TT
FDU2522	Q20PR-U11	Q20TT
FDU2522EVA	Q20PR-U11	Q20TT
GGP1	DG-001	-
GGP13	DG-143	-
GGP15	DG-124	-
GGP16	DG-104	-
GGP17	DG-012	-
GGP18	DG-001	-
GGP2	DG-001	-
GGP20	DG-198	-
GGP22	DG-001	-
GGP23	DG-003	-
GGP24	DG-101	-
GGP25	DG-005	-
GGP26	DG-102	-
GGP27	DG-119	-
GGP28	DG-006	-
GGP29	DG-001	-
GGP30	DG-106	-
GGP31	DG-115	-
GGP32	DG-012	-
GGP4	DG-012	-
GGP5	DG-123	-
GGP7	DG-001	-
GGP8	DG-004	-
GSP130	W16ESR-U	-
GSP131	W16EPR-U	W16TT
GSP141	W16EPR-U	W16TT
GSP151	W20EP-U	W20TT

UNIPART	DENSO	TT
GSP160	W20ESR-U	-
GSP163	W20EP-U	W20TT
GSP171	W20EP-U	W20TT
GSP181	W22EPR-U	W22TT
GSP191	W24EPR-U	-
GSP2001	K20PR-U	K20TT
GSP2002	W20EPR-U	W20TT
GSP2003	Q20PR-U	Q20TT
GSP2004	KJ20CR-L11	K20TT
GSP2005	K20PR-U11	K20TT
GSP2006	T20EPR-U	T20TT
GSP2007	K20PR-U	K20TT
GSP2008	W16EPR-U	W16TT
GSP2009	W20EPR-U	W20TT
GSP2010	W20EPB	W20TT
GSP2011	PT16VR13	TV16TT
GSP2012	T20EPR-U	T20TT
GSP2013	J16CR-U	W16TT
GSP2014	K20R-U	K20TT
GSP2015	K20R-U	K20TT
GSP2016	IK20	IK20TT
GSP2017	K20TXR	K20TT
GSP2018	K20TXR	K20TT
GSP2019	W20EPR-U11	W20TT
GSP2020	W16EPR-U	W16TT
GSP2021	MA20P-U	-
GSP2022	Q16PR-U	Q16TT
GSP2023	Q22PR-U	-
GSP2024	W20EPBR-S	W20TT
GSP2025	K16R-U	K16TT
GSP2026	MA20PR-U	-
GSP2027	T20EPR-U	T20TT
GSP2028	K20TXR	K20TT
GSP2029	W20FPR-U	WF20TT
GSP2030	W20EPBR-S	W20TT
GSP2031	W20EPB	W20TT
GSP2032	W16FSR	-
GSP2033	MA16PR-U	-
GSP2034	W16EPR-U	W16TT
GSP2035	Q16PR-U	Q16TT
GSP2036	W22EPR-U	W22TT
GSP2037	K20PR-U11	K20TT
GSP2038	W20EPBR-S	W20TT
GSP2039	W16EPR-U11	W16TT
GSP2040	T16EPR-U	T16TT
GSP2042	K20R-U11	K20TT
GSP2043	QJ16AR-U	-
GSP2044	IK22	-
GSP2045	Q16PR-U11	Q16TT
GSP2046	W20ESR-U	-
GSP2047	W20EPBR-S	W20TT
GSP2048	K20PBR	K20TT
GSP2049	W20FSR-U	WF20TT
GSP2050	W22FS-U	-
GSP2051	W24ESR-U	-
GSP2052	IK20	IK20TT
GSP2053	K20TNR-S	K20TT
GSP2054	T16EPR-U	T16TT
GSP2055	IK20	IK20TT
GSP2056	W20FPR-U	WF20TT
GSP2059	K20TXR	K20TT
GSP2060	K20PBR-S10	K20TT
GSP2061	IW20	IW20TT
GSP2062	IK22	-
GSP2063	X24EPR-U9	-
GSP2064	K20PBR	K20TT
GSP2098	W20EP-U	W20TT
GSP2099	W16EPR-U	W16TT
GSP2100	Q20PR-U	Q20TT
GSP2101	T20EPR-U	T20TT
GSP2102	T20EPR-U	T20TT

UNIPART	DENSO	TT
GSP2103	Q20PR-U	Q20TT
GSP2111	W20EPR-U	W20TT
GSP244	W16EPR-U	W16TT
GSP263	W20EPR-U	W20TT
GSP264	W16EPR-U	W16TT
GSP281	W22EPR-U	W22TT
GSP30	W20S-U	-
GSP331	T16EPR-U	T16TT
GSP351	T16EPR-U	T16TT
GSP361	T20EPR-U	T20TT
GSP381	T22EP-U	-
GSP4154	MA20P-U	-
GSP4154X	MA20P-U	-
GSP4256	W22FS-U	-
GSP4266	W16FSR	-
GSP4342	W24EPR-U	-
GSP4347	W22EPB	W22TT
GSP4352	W22EPR-U	W22TT
GSP4352X	W22EPR-U	W22TT
GSP4356	W22FPR-U	-
GSP4357	W22EPB	W22TT
GSP4362	W20EP-U	W20TT
GSP4362X	W20EP-U	W20TT
GSP4366	W20FPR-U	WF20TT
GSP4367	W20EPB	W20TT
GSP4372	W16EPR-U	W16TT
GSP4376	W16FPR-U	-
GSP4382	W16EPR-U	W16TT
GSP4382X	W16EPR-U	W16TT
GSP4452	W22EPR-U	W22TT
GSP44523	W20EPBR-S	W20TT
GSP4456	W22FPR-U	-
GSP4456X	W22FPR-U	-
GSP4462	W20EXR-U	W20TT
GSP44623	W20EPBR-S	W20TT
GSP4462X	W20EPR-U	W20TT
GSP4472	W16EPR-U	W16TT
GSP4482	W16EPR-U	W16TT
GSP4543	T22EP-U	-
GSP4547	K22PB	-
GSP4552	Q22PR-U	-
GSP4552X	Q22PR-U	-
GSP4553	T22EP-U	-
GSP4562	Q20PR-U	Q20TT
GSP4562X	Q20PR-U	Q20TT
GSP4563	T20EPR-U	T20TT
GSP4563X	T20EPR-U	T20TT
GSP4573	T16EPR-U	T16TT
GSP4642	Q22PR-U	-
GSP46515	PT16VR13	TV16TT
GSP4652	K22PR-U	-
GSP46522	K20TXR	K20TT
GSP46523	K20PBR-S10	K20TT
GSP4652X	Q22PR-U	-
GSP4657	K22PBR-S	-
GSP4662	K20PR-U	K20TT
GSP46622	K20TXR	K20TT
GSP46623	K20PBR-S10	K20TT
GSP4663	T20EPR-U	T20TT
GSP4663X	T20EPR-U	T20TT
GSP4664	T20PR-U	ITF20TT
GSP4763	T22EP-U	-
GSP4854	MA20PR-U	-
GSP531	W16FPR-U	-
GSP540	W20FSR-U	WF20TT
GSP541	W20FPR-U	WF20TT
GSP550	W20FSR-U	WF20TT
GSP560	W22FS-U	-
GSP5658	K20PR-U11	K20TT
GSP571	W22FPR-U	-
GSP6154	MA20P-U	-

UNIPART	DENSO	TT
GSP634	Q16PR-U	Q16TT
GSP6352	W22EPR-U	W22TT
GSP6356	W22FPR-U	-
GSP6362	W20EP-U	W20TT
GSP6366	W20FPR-U	WF20TT
GSP6382	W16EPR-U	W16TT
GSP6452	W22EPR-U	W22TT
GSP6452X	W22EPR-U	W22TT
GSP6458	W22EPR-U11	W22TT
GSP6462	W20EPR-U	W20TT
GSP6462X	W20EPR-U	W20TT
GSP6468	W20EPR-U11	W20TT
GSP6472	W16EPR-U	W16TT
GSP6478	W16EPR-U11	W16TT
GSP6552	Q22PR-U	-
GSP6553	T22EP-U	-
GSP6562	Q20PR-U	Q20TT
GSP6563	T20EPR-U	T20TT
GSP65721	Q16PR-U11	Q16TT
GSP6573	T16EPR-U	T16TT
GSP665	Q20PR-U	Q20TT
GSP6651	PT16VR13	TV16TT
GSP66514	PT16VR13	TV16TT
GSP6652	Q22PR-U	-
GSP66527	PK20PR11	K20TT
GSP6652X	Q22PR-U	-
GSP6658	Q22PR-U11	-
GSP6662	K20PR-U	K20TT
GSP6662X	K20PR-U	K20TT
GSP6663	T20EPR-U	T20TT
GSP6663X	T20EPR-U	T20TT
GSP684	Q22PR-U	-
GSP6854	MA20P-U	-
GSP6962	KJ20CR-L11	K20TT
GSP761	T20PR-U	ITF20TT
GSP7662	Q20PR-U11	Q20TT
GSP7664	KJ20CR-L11	K20TT
GSP7666	KJ16CR-L11	K16TT
GSP7669	W20EPR-U	W20TT
GSP881	T20PR-U	ITF20TT
GSP9652	PK20PR-P8	IK20TT
GSP981	MA20P-U	-
NLP007664EVA	KJ20CR-L11	K20TT
NLP007666EVA	KJ16CR-L11	K16TT
NLP100130	KJ20CR-L11	K20TT
XMH279	K20PR-U11	K20TT

VALEO	DENSO	TT
17C	M22	-
19C	M22	-
19L	M22	-
20C	M17	-
20E	M17	-
20L	M17	-
213	M24S	-
21C	M17	-
21E	M17	-
21L	M17	-
22L	M14	-
22LM	M14	-
232	W24FSR	-
232H	W24ESR-U	-
233	W24FSR	-
233H	W22ESR-U	-
345HS	W20EP-U	W20TT
34C	W22S-U	-
34CM	W22S-U	-
34HS	W22ESR-U	-
34HSM	W22ESR-U	-
34S	W22FS-U	-
35	W20FSR-U	WF20TT

VALEO	DENSO	TT
351	W20FPR-U	WF20TT
351B	W20FPR-U	WF20TT
351D	W20FPR-U	WF20TT
3536D	W20FPR-U	WF20TT
3536P	W20FPR-U	WF20TT
3536R	W20FPR-U	WF20TT
35B	W20FSR-U	WF20TT
35C	W20S-U	-
35CM	W20S-U	-
35HA	W20EP-U	W20TT
35HS	W20ESR-U	-
35M	W20FSR-U	WF20TT
35P	IWF22	-
35S	W22FS-U	-
36	W20FSR-U	WF20TT
36B	W16FSR	-
36C	W14PR-U	-
36CM	W16S-U	-
36D	W16FSR	-
36HS	W16ESR-U	-
36M	W16FSR	-
36P	IWF16	-
37S	W16FSR	-
3H	W27ESR-U	-
4N	W22FS-U	-
5H	W22EPR-U	W22TT
5N	W20FSR-U	WF20TT
64H	W22EPR-U	W22TT
64H3E	W22EPB	W22TT
67HP	IW24	-
6H	W20EP-U	W20TT
6N	W20FSR-U	WF20TT
70H	W22EPR-U	W22TT
70H3E	W22EPB	W22TT
76H	W20EP-U	W20TT
76H3E	W20EPB	W20TT
7H	W20EP-U	W20TT
84H	W16EPR-U	W16TT
84H3E	W20EPB	W20TT
88N	W20FPR-U	WF20TT
8H	W20EP-U	W20TT
90H	W16EPR-U	W16TT
90N	W16FPR-U	-
9H	W16EPR-U	W16TT
AC422Z	W20FSR-U	WF20TT
C55HP	IT27	-
C60H	T22EP-U	-
C62HP	IT22	-
C64H	T22EP-U	-
C64HP	IT22	-
C68H	T20EPR-U	T20TT
C72H	T20EPR-U	T20TT
C7H	T22EP-U	-
C8H	T20EPR-U	T20TT
F64H	Q22PR-U	-
F68H3	K22PB	-
F70H	Q22PR-U	-
F72H	Q22PR-U	-
F72H3	K22PB	-
F72H3E	K22PB	-
F74H	Q20PR-U	Q20TT
F74H3	K20PBR	K20TT
F80H	Q20PR-U	Q20TT
GC68N	MA20P-U	-
GC72N	MA20P-U	-
GT34	W22FPR-U	-
GT342H	W20EP-U	W20TT
GT345	W20FPR-U	WF20TT
GT345D	W20FPR-U	WF20TT
GT345H	W20EP-U	W20TT
GT345HA	W20EP-U	W20TT

Spark & Glow Plugs

Cross Reference Chart - Competitor

VALEO	DENSO	TT
GT345HD	W20EP-U	W20TT
GT34D	W22FPR-U	-
GT34H	W22EPR-U	W22TT
GT34HD	W20EP-U	W20TT
GT35	W20FSR-U	WF20TT
GT35D	W16FPR-U	-
GT35H	W16EPR-U	W16TT
GT35HD	W16EPR-U	W16TT
H32RG	IW27	-
H33RG	IW24	-
H34F	W24ESR-U	-
HA322	W24ESR-U	-
HA32RS	IW27	-
HF33R	IW27	-
HF34	W22ESR-U	-
HF34F	W24ESR-U	-
M101	T20EPR-U	T20TT
M103	W20FPR-U	WF20TT
M104	T22EP-U	-
M123	Q20PR-U	Q20TT
M127	W20EPR-U	W20TT
M132	K20TNR-S	K20TT
M4T	W24S-U	-
M5T	W22S-U	-
M6T	W20S-U	-
R64H	W22EPR-U	W22TT
R64H11	W22EPR-U11	W22TT
R70H	W22EPR-U	W22TT
R70H11	W22EPR-U11	W22TT
R70H3E	W22EPB	W22TT
R76H	W20EPR-U	W20TT
R76H11	W20EPR-U11	W20TT
R84H	W16EPR-U	W16TT
R84H11	W16EPR-U11	W16TT
R84HZ3YE	W20EPBR-S	W20TT
R84HZY	J16CR-U	W16TT
R88N	W20FPR-U	WF20TT
R90H	W16EPR-U	W16TT
R90H11	W16EPR-U11	W16TT
R92H	W14EXR-U	IW16TT
RC64H	IT22	-
RC68H	T20EPR-U	T20TT
RC68LPP	PT16VR13	TV16TT
RC72H	T20EPR-U	T20TT
RC72H11	T20EPR-U	T20TT
RF64H	Q22PR-U	-
RF64H11	Q22PR-U11	-
RF72H	Q22PR-U	-
RF72H11	Q22PR-U11	-
RF72H3E	K22PBR-S	-
RF72HZ3YE	K22PBR-S	-
RF72HZDC	Q22PR-U	-
RF74H	Q20PR-U	Q20TT
RF74H11	Q20PR-U11	Q20TT
RF74H3	K20PBR	K20TT
RF74HZ	K20R-U	K20TT
RF74HZ11	K20R-U11	K20TT
RF74HZ2	K20TNR	K20TT
RF74HZ2Y	K20TXR	K20TT
RF74HZ3YE	K20PBR-S10	K20TT
RF74HZDC	K20PR-U	K20TT
RF74HZY11	KJ20CR-L11	K20TT
RF74LZDC	IKH20	IKH20TT
RF80H	Q16PR-U	Q16TT
RF80H11	Q16PR-U	Q16TT
RF80H3	K20PBR-S10	K20TT
RF80HZ2Y	K20TXR	K20TT
RF80HZY	K16R-U	K16TT
RF80LZDC	K16HPR-U11	KH16TT
RF82H	Q16PR-U	Q16TT
RF82H11	Q16PR-U11	Q16TT

VALEO	DENSO	TT
RF82H2Y	K16TNR-S9	K16TT
RGC68N	MA20PR-U	-
RR31HS	IW31	-
RR32HS	IW27	-
RR33HSS	IW31	-
S5N	M22	-
S6N	M17	-
SCGT345H	T22EP-U	-
SCGT35H	T20EPR-U	T20TT
T6	W22M-U	-
T7	W20MP-U	-
T8	W20M-US	-
TC6	T22M-U	-
TC8	T20M-U	-
V36A	W16FSR	-
V6N	W16FSR	-







WLD	DENSO	TT
A7TC	U22FSR-U	-
D7	X22ESR-U	-
D8EA	X24ESR-U	-
D8RTC	X24ESR-U	-
D8TC	X24ESR-U	-
E6C	W20FSR-U	WF20TT
E6TC	W20FPR-U	WF20TT
E7C	W22FS-U	-
E7TC	W22FPR-U	-
F5TC	W16EPR-U	W16TT
F6TC	W20EX-U	W20TT
F7TC	W22EPR-U	W22TT
F7TJC	W20EPB	W20TT
K6TC	Q16R-U	Q16TT
K6TJC	K20PBR	K20TT
K7TC	Q20R-U	Q20TT
K7TJC	K22PB	-
L7	W20M-US	-
L7T	W20MP-U	-
L9	W22M-U	-
L9T	W22MPR-U	-
T4T	MA16PR-U	-
T5RTC	MA20PR-U	-

YANMAR	DENSO	TT
129155-77800	DG-157	-







DENSO Iridium Upgrade









Spark Plugs | Iridium Upgrade

						
-	DK20PR-D13	-	-	-	VFK20F	-
-	FK16R11	-	IK16TT	-	VFK16	-
-	FK20HBR11	-	IKBH20TT	-	VFKBH20	-
-	FK20HR11	-	IKH20TT	-	VFKH20	-
-	FXE20HE11	-	IXEH20ETT	-	VFXEH20E	-
-	FXE20HR11	-	IXEH20TT	-	VFXEH20	-
-	IK16	-	IK16TT	IK16	VK16	-
-	IK16G	-	-	IK16G	VK16G	-
-	IK16L	-	IK16TT	IK16L	VKA16	-
-	IK20	-	IK20TT	IK20	VK20	-
-	IK20G	-	IK20TT	IK20G	VK20G	-
-	IK20L	-	IK20TT	IK20L	VKA20	-
-	IK22	-	-	IK22	VK22	-
-	IK22G	-	-	IK22G	VK22G	-
-	IK24	-	-	IK24	-	-
-	IK24C11	-	-	IK24	-	-
-	IK27	-	-	IK27	-	-
-	IK27C11	-	-	IK27	-	-
-	IK31	-	-	IK31	-	-
-	IK34	-	-	IK34	-	-
-	IKH16	-	IKH16TT	IKH16	VKH16	-
-	IKH20	-	IKH20TT	IKH20	VKH20	-
-	IKH22	-	-	IKH22	VKH22	-
-	IKH24	-	-	IKH24	-	-
-	IKH27	-	-	IKH27	-	-
-	IQ16	-	IQ16TT	IQ16	VQ16	-
-	IQ20	-	IQ20TT	IQ20	VQ20	-
-	IQ22	-	-	IQ22	VQ22	-
-	IQ24	-	-	IQ24	-	-
-	IQ27	-	-	IQ27	-	-
-	IQ31	-	-	IQ31	-	-
-	IQ34	-	-	IQ34	-	-
-	IT16	-	IT16TT	IT16	VT16	-
-	IT20	-	IT20TT	IT20	VT20	-
-	IT22	-	-	IT22	-	-
-	IT24	-	-	IT24	-	-
-	IT27	-	-	IT27	-	-
-	ITF16	-	ITF16TT	ITF16	-	-
-	ITF20	-	ITF20TT	ITF20	-	-
-	ITF22	-	-	ITF22	-	-
-	ITF24	-	-	ITF24	-	-
-	ITF27	-	-	ITF27	-	-
-	ITL16	-	ITL16TT	ITL16	-	-
-	ITL20	-	-	ITL20	-	-
-	ITV16	-	ITV16TT	ITV16	-	-
-	ITV20	-	ITV20TT	ITV20	-	-
-	ITV22	-	-	ITV22	-	-
-	ITV24	-	-	ITV24	-	-
-	ITV27	-	-	ITV27	-	-
-	IU20	-	-	IU20	-	-
-	IU22	-	-	IU22	-	-
-	IU24	-	-	IU24	-	-
-	IU24A	-	-	IU24A	-	-
-	IU24D	-	-	IU24D	-	-
-	IU27	-	-	IU27	-	-
-	IU27A	-	-	IU27A	-	-
-	IU27D	-	-	IU27	-	-
-	IU31	-	-	IU31	-	-
-	IU31A	-	-	IU31A	-	-
-	IUF22	-	-	IUF22	-	-
-	IUF24	-	-	IUF24	-	-
-	IUF27A	-	-	IUF27A	-	-
-	IUF31A	-	-	IUF31A	-	-
-	IUH24	-	-	IUH24	-	-
-	IUH24D	-	-	IUH24	-	-
-	IUH27	-	-	IUH27	-	-
-	IUH27D	-	-	IUH27	-	-
-	IW16	-	IW16TT	IW16	VW16	-
-	IW20	-	IW20TT	IW20	VW20	-







Spark Plugs | Iridium Upgrade

						
-	IW22	-	-	IW22	VW22	-
-	IW24	-	-	IW24	-	-
-	IW27	-	-	IW27	-	-
-	IW29	-	-	IW29	-	-
-	IW31	-	-	IW31	-	-
-	IW34	-	-	IW34	-	-
-	IWF16	-	-	IWF16	-	-
-	IWF20	-	-	IWF20	-	-
-	IWF22	-	-	IWF22	-	-
-	IWF24	-	-	IWF24	-	-
-	IWF27	-	-	IWF27	-	-
-	IWM24	-	-	IWM24	-	-
-	IWM27	-	-	IWM27	-	-
-	IWM31	-	-	IWM31	-	-
-	IX22	-	-	IX22	-	-
-	IX22B	-	-	IX22B	-	-
-	IX24	-	-	IX24	-	-
-	IX24B	-	-	IX24B	-	-
-	IX27	-	-	IX27	-	-
-	IX27B	-	-	IX27B	-	-
-	IXG24	-	-	IXG24	-	-
-	IXG27	-	-	IXG27	-	-
-	IXU22	-	-	IXU22	VXU22	-
-	IXU24	-	-	IXU24	VXU24	-
-	IXU27	-	-	IXU27	-	-
-	IXUH20I	-	-	IXUH20I	VXUH20I	-
-	IXUH22	-	-	IXUH22	VXUH22	-
-	IXUH22I	-	-	IXUH22I	VXUH22I	-
-	IY24	-	-	IY24	-	-
-	IY27	-	-	IY27	-	-
-	IY31	-	-	IY31	-	-
J16A-U11	J16AR-U11	-	-	-	-	-
J16C-U	J16CR-U	W16TT	IW16TT	IW16	VW16	-
-	K16HPR-U11	KH16TT	IKH16TT	IKH16	VKH16	-
-	K16HR-U11	KH16TT	IKH16TT	IKH16	VKH16	-
-	K16PR-L11	K16TT	IK16TT	IK16	VK16	-
-	K16PSR-B8	-	IK16TT	IK16	VK16	-
K16P-U	K16PR-U	K16TT	IK16TT	IK16	VK16	-
K16P-U11	K16PR-U11	K16TT	IK16TT	IK16	VK16	-
-	K16TNR-S9	K16TT	IK16TT	IK16	VK16	-
-	K16TR11	K16TT	IK16TT	IK16	VK16	-
-	K16TT	K16TT	IK16TT	IK16	VK16	-
K16-U	K16R-U	K16TT	IK16TT	IK16	VK16	-
K16-U11	K16R-U11	K16TT	IK16TT	IK16	VK16	-
-	K20BR-S10	K20TT	IK20TT	IK20	VK20	-
-	K20HR-U11	KH20TT	IKH20TT	IKH20	VKH20	-
-	K20PBR	K20TT	IK20TT	IK20	VK20	-
-	K20PBR-S10	K20TT	IK20TT	IK20	VK20	-
-	K20PR-L11	K20TT	IK20TT	IK20	VK20	-
-	K20PSR-B8	-	IK20TT	IK20	VK20	-
K20P-U	K20PR-U	K20TT	IK20TT	IK20	VK20	-
K20P-U11	K20PR-U11	K20TT	IK20TT	IK20	VK20	-
-	K20TNR	K20TT	IK20TT	IK20	VK20	-
-	K20TNR-S	K20TT	IK20TT	IK20	VK20	-
-	K20TNR-S9	K20TT	IK20TT	IK20	VK20	-
-	K20TR11	K20TT	IK20TT	IK20	VK20	-
-	K20TT	K20TT	IK20TT	IK20	VK20	-
-	K20TXR	K20TT	IK20TT	IK20	VK20	-
K20-U	K20R-U	K20TT	IK20TT	IK20	VK20	-
K20-U11	K20R-U11	K20TT	IK20TT	IK20	VK20	-
K22PB	K22PBR-S	-	-	IK22	VK22	-
-	K22PR-L11	-	-	IK22	VK22	-
-	K22PR-U	-	-	IK22	VK22	-
-	K22PR-U11	-	-	IK22	VK22	-
-	K22TNR-S	-	-	IK22	VK22	-
-	K24PR-U11	-	-	IK24	-	-
-	KH16TT	KH16TT	IKH16TT	IKH16	VKH16	-
-	KH20TT	KH20TT	IKH20TT	IKH20	VKH20	-







Spark Plugs | Iridium Upgrade

						
-	KJ14CR11	-	-	IK16L	VK16	-
-	KJ14CR-L11	-	-	IK16L	VK16	-
-	KJ16CR11	K16TT	IK16TT	IK16L	VK20T	-
-	KJ16CR-L11	K16TT	IK16TT	IK16L	VK16	-
-	KJ16CR-U11	K16TT	IK16TT	IK16L	VK20T	-
-	KJ20CR-L11	K20TT	IK20TT	IK20L	VK20	-
-	KJ20CR-U11	K20TT	IK20TT	IK20L	VK20	-
-	KJ20DR-M11	-	IK20TT	IK20L	-	-
-	KJ20SR11	-	IK20TT	IK20L	VK20	-
-	KJ22CR-L11	-	-	IK22	VK22	-
-	KJ22CR-L8	-	-	IK22	VK22	-
MA16P-U	MA16PR-U	-	-	-	-	-
MA20P-U	MA20PR-U	-	-	-	-	-
-	N24EXRB	-	-	IU24	-	-
-	P16PR11	W16TT	IW16TT	IW16	VW16	-
-	P16R	W20TT	IW20TT	IW20	VW20T	-
-	P16R13	W20TT	IW20TT	IW20	VW20T	-
-	P20PR11	W20TT	IW20TT	IW20	VW20	-
-	P22PR8	-	-	IW22	VW22	-
-	PK16PR11	K16TT	IK16TT	IK16	VK16	-
-	PK16PR-L11	-	IK16TT	IK16	VK16	-
-	PK16PR-P11	K16TT	IK16TT	IK16	VK16	-
-	PK16R11	K16TT	IK16TT	IK16	VK16	-
-	PK16R8	-	IK16TT	IK16	VK16	-
-	PK16TR11	K16TT	IK16TT	IK16	VK16	-
-	PK16TR13	K16TT	IK16TT	IK16	VK16	-
-	PK20GR8	-	-	IK20L	VKA20	-
-	PK20PR11	K20TT	IK20TT	IK20	VK20	-
-	PK20PR-L11	-	IK20TT	IK20	VK20	-
-	PK20PR-L13	-	IK20TT	IK20	VK20	-
-	PK20PR-P11	K20TT	IK20TT	IK20	VK20	-
-	PK20PR-P8	-	IK20TT	IK20	VK20Y	-
-	PK20PTR-S9	K20TT	IK20TT	IK20	VK20	-
-	PK20R11	K20TT	IK20TT	IK20	VK20	-
-	PK20R13	K20TT	IK20TT	IK20	VK20	-
-	PK20R8	-	IK20TT	IK20	VK20	-
-	PK20TR11	K20TT	IK20TT	IK20	VK20	-
-	PK22PR11	-	-	IK22	VK22	-
-	PK22PR8	-	-	IK22	VK22	-
-	PK22PR-L11S	-	-	IK22G	VK22G	-
-	PKJ16CR8	-	-	IK16L	VK16	-
-	PKJ16CR-L11	-	IK16TT	IK16L	VK16	-
-	PKJ16CR-L13	-	IK16TT	IK16L	VK16	-
-	PKJ20CR8	-	-	IK20L	VK20G	-
-	PKJ20CR-L11	-	IK20TT	IK20L	VK20	-
-	PKJ20CR-M11	-	IK20TT	IK20L	-	-
-	PQ16R	Q16TT	IQ16TT	IQ16	VQ16	-
-	PQ16R8	Q16TT	IQ16TT	IQ16	VQ16	-
-	PQ20R	Q20TT	IQ20TT	IQ20	VQ20	-
-	PQ20R-P8	-	IQ20TT	IQ20	VQ20	-
-	PT16EPR-L13	-	IT16TT	IT16	VT16	-
-	PT16VR10	TV16TT	ITV16TT	ITV16	-	-
-	PT16VR13	TV16TT	ITV16TT	ITV16	-	-
-	PTJ16R15	-	IT16TT	IT16	VT16	-
-	Q14R-U11	-	IQ16TT	IQ16	VQ16	-
-	Q16PR-U	Q16TT	IQ16TT	IQ16	VQ16	-
Q16P-U11	Q16PR-U11	Q16TT	IQ16TT	IQ16	VQ16	-
-	Q16TT	Q16TT	IQ16TT	IQ16	VQ16	-
Q16-U	Q16R-U	Q16TT	IQ16TT	IQ16	VQ16	-
Q16-U11	Q16R-U11	Q16TT	IQ16TT	IQ16	VQ16	-
Q20P-U	Q20PR-U	Q20TT	IQ20TT	IQ20	VQ20	-
Q20P-U11	Q20PR-U11	Q20TT	IQ20TT	IQ20	VQ20	-
-	Q20TT	Q20TT	IQ20TT	IQ20	VQ20	-
Q20-U	Q20R-U	Q20TT	IQ20TT	IQ20	VQ20	-
Q20-U11	Q20R-U11	Q20TT	IQ20TT	IQ20	VQ20	-
Q22P-U	Q22PR-U	-	-	IQ22	VQ22	-
Q22P-U11	Q22PR-U11	-	-	IQ22	VQ22	-
QJ14C11	QJ16CR11	Q16TT	IQ16TT	IQ16	VQ16	-
QJ16C11	QJ16CR11	Q16TT	IQ16TT	IQ16	VQ16	-







Spark Plugs | Iridium Upgrade

						
QJ20C11	QJ20CR11	Q20TT	IQ20TT	IQ20	VQ20	-
-	S22PR-A7	-	-	IW22	VW22	-
-	SC16HR11	-	IXEH20TT	-	VFXEH20	-
-	SC20HR11	-	IXEH22TT	-	VFXEH22	-
-	SK16HR11	-	IKH16TT	IKH16	VKH16	-
-	SK16PR-A11	-	IK16TT	IK16	VK16	-
-	SK16PR-E11	-	IK16TT	IK16	VK16	-
-	SK16PR-L11	-	IK16TT	IK16	VK16	-
-	SK16R11	-	IK16TT	IK16	VK16	-
-	SK16R-P11	-	IK16TT	IK16	VK16	-
-	SK16R-P8	-	IK16TT	IK16	VK16	-
-	SK20BGR11	-	-	-	VKA20	-
-	SK20BR11	-	-	-	VKB20	-
-	SK20HR11	-	IKH20TT	IKH20	VKH20	-
-	SK20PR-A11	-	IK20TT	IK20	VK20	-
-	SK20PR-A8	-	IK20TT	IK20	VK20	-
-	SK20PR-L11	-	IK20TT	IK20	VK20	-
-	SK20PR-L9	-	IK20TT	IK20	VK20	-
-	SK20R11	-	IK20TT	IK20	VK20	-
-	SK20R-P11	-	IK20TT	IK20	VK20	-
-	SK20R-P13	-	IK20TT	IK20	VK20	-
-	SK22PR-M11	-	-	IK22	VK22	-
-	SK22PR-M11S	-	-	IK22G	VK22G	-
-	SKJ16CR-A8	-	-	IK16L	-	-
-	SKJ16CR-L11	-	IK16TT	IK16L	-	-
-	SKJ16DR-M11	-	IK16TT	IK16L	-	-
-	SKJ20CR-A8	-	-	IK20L	-	-
-	SKJ20DR-M11	-	IK20TT	IK20L	-	-
-	SKJ20DR-M11S	-	-	IK20G	-	-
-	SKJ20DR-M13	-	IK20TT	IK20L	-	-
-	SVK20RZ8	-	IK20TT	-	VK20Y	-
-	SXU22HCR11S	-	-	-	VXUHC22G	-
-	SXU22HDR8	-	-	IXUH22	VXUH22	-
-	SXU22PR9	-	-	IXU22I	VXU22I	-
-	T14PR-U	-	ITF16TT	ITF16	-	-
-	T16EPR-U15	T16TT	IT16TT	IT16	VT16	-
T16EX-U	T16EPR-U	T16TT	IT16TT	IT16	VT16	-
-	T16NR-U11	-	IT16TT	IT16	VT16	-
-	T16PR-U11	-	ITF16TT	ITF16	-	-
-	T16PR-U15	-	ITF16TT	ITF16	-	-
T16P-U	T16PR-U	-	ITF16TT	ITF16	-	-
-	T16R-U	-	IT16TT	IT16	VT16	-
-	T16TT	T16TT	IT16TT	IT16	VT16	-
-	T16VR-U10	TV16TT	ITV16TT	ITV16	-	-
T20EP-U	T20EPR-U	T20TT	IT20TT	IT20	VT20	-
T20EP-U15	T20EPR-U15	T20TT	IT20TT	IT20	VT20	-
-	T20NR-U11	-	IT20TT	IT20	VT20	-
-	T20PR-U11	-	ITF20TT	ITF20	-	-
-	T20PR-U15	-	ITF20TT	ITF20	-	-
T20P-U	T20PR-U	-	ITF20TT	ITF20	-	-
-	T20TT	T20TT	IT20TT	IT20	VT20	-
TR20	W20FSR-U	WF20TT	-	IWF20	-	-
TR24	W24FSR	-	-	IWF24	-	-
TR24-10	W24FSR-U10	-	-	IWF24	-	-
-	TV16TT	TV16TT	ITV16TT	ITV16	-	-
U14FS-UB	U14FSR-UB	-	-	IUF14-UB	-	-
U16FS-U	U16FSR-U	-	-	-	-	-
U16FS-UB	U16FSR-UB	-	-	-	-	-
-	U20EPR9	-	-	IU20	-	-
-	U20ESR-N	-	-	IU20	-	-
U20FS-U	U20FSR-U	-	-	IUF22	-	-
-	U22EPR9	-	-	IU22	-	-
U22ES-N	U22ESR-N	-	-	IU22	-	-
-	U22ETR	-	-	IU22	-	-
-	U22FER9	-	-	IUH24	-	-
U22FS-U	U22FSR-U	-	-	IUF22	-	-
-	U24EPR9	-	-	IU24A	-	-
U24ES-N	U24ESR-N	-	-	IU24	-	IU01-24
-	U24ESR-NB	-	-	IU24	-	-







Spark Plugs | Iridium Upgrade

						
-	U24ETR	-	-	IU24A	-	-
U24FE9	U24FER9	-	-	IUH24	-	IU01-24
U24FS-C	U24FSR-U	-	-	IUF24	-	-
U24FS-U	U24FSR-U	-	-	IUF24	-	-
U27ES-N	U27ESR-N	-	-	IU27	-	IU01-27 / RU01-27
-	U27ESR-NB	-	-	IU27	-	-
-	U27ETR	-	-	IU27A	-	-
U27FE9	U27FER9	-	-	IUH27	-	IU01-27 / RU01-27
-	U31ESR-N	-	-	IU31	-	-
-	U31ETR	-	-	IU31A	-	-
-	VCH20	-	IXEH22TT	-	VCH20	-
-	VFKBH20	-	IKBH20TT	-	VFKBH20	-
-	VFKH16	-	IKH16TT	-	VFKH16	-
-	VFKH20	-	IKH20TT	-	VFKH20	-
-	VFXEH20	-	IXEH20TT	-	VFXEH20	-
-	VFXEH20E	-	IXEH20ETT	-	VFXEH20E	-
-	VFXEH22	-	IXEH22TT	-	VFXEH22	-
-	VK16	-	IK16TT	IK16	VK16	-
-	VK16G	-	IK16TT	IK16G	VK16G	-
-	VK16PRZ11	-	IK16TT	IK16	VK16	-
-	VK20	-	IK20TT	IK20	VK20	-
-	VK20G	-	-	IK20G	VK20G	-
-	VK20PRZ11	-	IK20TT	IK20	VK20	-
-	VK20T	-	IK20TT	-	VK20T	-
-	VK20Y	-	-	-	VK20Y	-
-	VK22	-	-	IK22	VK22	-
-	VK22G	-	-	IK22G	VK22G	-
-	VK22PRZ11	-	-	IK22	VK22	-
-	VK24PRZ11	-	-	IK24	-	-
-	VK27PRZ11	-	-	IK27	-	-
-	VKA16	-	-	-	VKA16	-
-	VKA20	-	-	-	VKA20	-
-	VKB16	-	-	-	VKB16	-
-	VKB20	-	-	-	VKB20	-
-	VKH16	-	IKH16TT	IKH16	VKH16	-
-	VKH20	-	IKH20TT	IKH20	VKH20	-
-	VKH20Y	-	IKH20TT	-	VKH20Y	-
-	VKH22	-	-	IKH22	VKH22	-
-	VQ16	-	IQ16TT	IQ16	VQ16	-
-	VQ20	-	IQ20TT	IQ20	VQ20	-
-	VQ22	-	-	IQ22	VQ22	-
-	VT16	-	IT16TT	IT16	VT16	-
-	VT20	-	IT20TT	IT20	VT20	-
-	VUH24D	-	-	IUH24	-	-
-	VUH27D	-	-	IUH27	-	-
-	VW16	-	IW16TT	IW16	VW16	-
-	VW20	-	IW20TT	IW20	VW20	-
-	VW20T	-	IW20TT	-	VW20T	-
-	VW22	-	-	IW22	VW22	-
-	VXEBH27	-	-	-	VXEBH27	-
-	VXU22	-	-	IXU22	VXU22	-
-	VXU24	-	-	IXU24	VXU24	-
-	VXUH20I	-	-	IXUH20I	VXUH20I	-
-	VXUH22	-	-	IXUH22	VXUH22	-
-	VXUH22I	-	-	IXUH22I	VXUH22I	-
-	VXUHC22G	-	-	-	VXUHC22G	-
W14EP-U	W14EPR-U	W16TT	IW16TT	IW16	VW16	-
W14EX-U	W14EXR-U	-	IW16TT	IW16	VW16	-
W14EX-U11	W14EXR-U11	-	IW16TT	IW16	VW16	-
W14FP	W14FPR-U	-	-	IWF16	-	-
W14FP-L	W14FPR-UL	-	-	IWF16	-	-
W14FP-U	W14FPR-U	-	-	IWF16	-	-
W14FP-UL	W14FPR-UL	-	-	IWF16	-	-
W14FP-UL10	W14FPR-UL10	-	-	IWF16	-	-
-	W14FR-L	-	-	IWF16	-	-
W14F-U	W14FR-U	-	-	-	-	-
W14F-U10	W14FR-U	-	-	-	-	-
W14MP-U10	W14MPR-U10	-	-	-	-	-
W14M-U	W14MR-U	-	-	-	-	-

Spark Plugs | Iridium Upgrade

						
W14M-U10	W14MR-U	-	-	-	-	-
W14M-US	W14MR-U	-	-	-	-	-
W14P-U	W14PR-U	-	-	-	-	-
W16EK-S11	W16EKR-S11	W16TT	IW16TT	IW16	VW16	-
W16EP-U	W16EPR-U	W16TT	IW16TT	IW16	VW16	-
W16EP-U11	W16EPR-U11	W16TT	IW16TT	IW16	VW16	-
W16ES-U	W16ESR-U	-	-	-	-	-
W16ET-L	W16ETR-S	W16TT	IW16TT	IW16	VW16	-
W16ET-S	W16ETR-S	W16TT	IW16TT	IW16	VW16	-
W16EX-U	W16EXR-U	W16TT	IW16TT	IW16	VW16	-
W16EX-U11	W16EXR-U11	W16TT	IW16TT	IW16	VW16	-
W16EX-U13	W16EXR-U13	W16TT	IW16TT	IW16	VW16	-
W16FP	W16FPR-U	-	-	IWF16	-	-
W16FP-U	W16FPR-U	-	-	IWF16	-	-
W16FP-U10	W16FPR-U	-	-	IWF16	-	-
W16FP-UL	W16PR-U	-	-	-	-	-
W16FS	W16FSR	-	-	IWF16	-	-
W16FS-U	W16FSR	-	-	IWF16	-	-
W16P-U	W16PR-U	-	-	-	-	-
-	W16TT	W16TT	IW16TT	IW16	VW16	-
W20EK-S11	W20EKR-S11	-	IW20TT	IW20	VW20	-
W20EPB	W20EPBR-S	W20TT	IW20TT	IW20	VW20	-
W20EP-S11	W20EPR-S11	W20TT	IW20TT	IW20	VW20	-
W20EP-U	W20EPR-U	W20TT	IW20TT	IW20	VW20	-
W20EP-U11	W20EPR-U11	W20TT	IW20TT	IW20	VW20	-
W20ES-L	W20EKR-S11	-	IW20TT	IW20	VW20	-
W20ES-L11	W20EKR-S11	-	IW20TT	IW20	VW20	-
W20ES-U	W20ESR-U	-	-	-	-	-
W20ET-L	W20ETR-L	W20TT	IW20TT	IW20	VW20	-
W20EX-U	W20EXR-U	W20TT	IW20TT	IW20	VW20T	-
W20EX-U11	W20EXR-U11	W20TT	IW20TT	IW20	VW20T	-
W20FP-U	W20FPR-U	WF20TT	-	IWF20	-	-
W20FP-U10	W20FPR-U10	WF20TT	-	IWF20	-	-
-	W20FR-L	WF20TT	-	IWF20	-	-
W20FS-U	W20FSR-U	WF20TT	-	IWF20	-	-
W20FS-U10	W20FSR-U	WF20TT	-	IWF20	-	-
W20MP-U10	W20MPR-U10	-	-	-	-	-
W20M-U	W20MR-U	-	-	-	-	-
W20P-U	W20PR-U	-	-	-	-	-
W20S-U	W20SR-U	-	-	-	-	-
-	W20TT	W20TT	IW20TT	IW20	VW20	-
W21ES-L11	W20EKR-S11	-	IW20TT	IW20	VW20	-
W22EA	W22EBR	-	-	-	-	-
W22EB	W22EBR	-	-	-	-	-
W22EP-U	W22EPR-U	W22TT	-	IW22	VW22	-
W22EP-U11	W22EPR-U11	W22TT	-	IW22	VW22	-
W22ES-U	W22ESR-U	-	-	-	-	-
W22ET-L	W22ETR-L	-	-	IW22	VW22	-
W22FP-U	W22FPR-U	-	-	IWF22	-	-
W22FS	W22FSR	-	-	IWF22	-	-
W22FS-U	W22FSR	-	-	IWF22	-	-
W22FS-U10	W22FSR	-	-	IWF22	-	-
W22MP-U	W22MPR-U	-	-	-	-	-
-	W22TT	W22TT	-	IW22	VW22	-
-	W24EMR-C	-	-	IWM24	-	-
W24EP-U	W24EPR-U	-	-	IW24	-	IW01-24
-	W24ESR	-	-	IW24	-	-
W24ES-U	W24ESR-U	-	-	IW24	-	IW01-24
W24ES-V	W24ESR-V	-	-	IW24	-	IW01-24
W24FP	W24FPR	-	-	IWF24	-	-
W24FP-U	W24FPR-U10	-	-	IWF24	-	-
-	W24FR-L	-	-	IWF24	-	-
W24FS	W24FSR	-	-	IWF24	-	-
W24FS-U	W24FSR	-	-	IWF24	-	-
W24FS-U10	W24FSR-U10	-	-	IWF24	-	-
W25EA	W27EBR	-	-	-	-	-
W25EB	W27EBR	-	-	-	-	-
-	W27EMR-C	-	-	IWM27	-	-

Spark Plugs | Iridium Upgrade

						
W27ES-C	W27ESR-U	-	-	IW27	-	IW01-27 / IW06-27
-	W27ESR	-	-	IW27	-	-
W27ES-U	W27ESR-U	-	-	IW27	-	IW01-27 / IW06-27
W27ES-V	W27ESR-V	-	-	IW27	-	IW01-27 / IW06-27
W27FS-U	W27FSR	-	-	IWF27	-	-
W27FS-U10	W27FSR-U10	-	-	IWF27	-	-
W31ES-U	W31ESR-U	-	-	IW31	-	IW01-31 / IW06-31
W9LM-US	W9LMR-US	-	-	-	-	-
W9P-U	W9PR-U	-	-	-	-	-
-	WF20TT	WF20TT	-	IWF20	-	-
X16EP-U9	X16EPR-U9	-	-	-	-	-
X16FS-U	X16FSR-U	-	-	-	-	-
X20EP-U9	X20EPR-U9	-	-	IX22B	-	-
X20ES-U	X20ESR-U	-	-	-	-	-
X20FS-U	X20FSR-U	-	-	-	-	-
X22EP-U9	X22EPR-U9	-	-	IX22B	-	-
X22ES-U	X22ESR-U	-	-	IX22	-	-
X24EP-U9	X24EPR-U9	-	-	IX24B	-	IXU01-24
X24ES-U	X24ESR-U	-	-	IX24	-	IXU01-24
X24GP-U	X24GPR-U	-	-	IXG24	-	IXU01-24
X27EP-U9	X27EPR-U9	-	-	IX27B	-	IXU01-27
X27ES-U	X27ESR-U	-	-	IX27	-	IXU01-27
X27ET	X2ETR	-	-	IX27	-	IXU01-27
X27GP-U	X27GPR-U	-	-	IXG27	-	IXU01-27
X31ES-U	X31ESR-U	-	-	-	-	IXU01-31
-	XE20HR-U9	-	IXEH20TT	-	VFXEH20	-
XU20EP-U	XU20EPR-U	-	-	IXU22	VXU22	-
XU22EP-U	XU22EPR-U	XU22TT	-	IXU22	VXU22	-
-	XU22HDR9	XUH22TT	-	IXUH22	VXUH22	-
-	XU22PR9	XU22TT	-	IXU22I	VXU22I	-
-	XU22TT	XU22TT	-	IXU22	VXU22	-
XU24EP-U	XU24EPR-U	-	-	IXU24	VXU24	IXU01-24
-	XU27EPR-U	-	-	IXU27	-	-
-	XUH20TTi	XUH20TTi	-	IXUH20i	VXUH20i	-
-	XUH22TT	XUH22TT	-	IXUH22	VXUH22	-
-	Y24FER-C	-	-	IY24	-	-
-	Y27FER-C	-	-	IY27	-	-
-	Y31FER-C	-	-	IY31	-	-
-	ZT20EPR11	T20TT	IT20TT	IT20	VT20	-
-	ZXU20PR11	-	-	IXU22	VXU22	-

DENSO Photo Guide



Glow Plugs | Photo Guide

DG-001

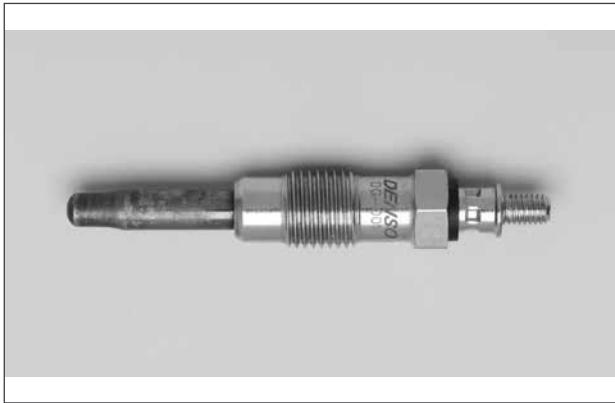

DG-006



DG-003



DG-007



DG-004



DG-008



DG-005



DG-009



Glow Plugs | Photo Guide

DG-010



DG-104



DG-012



DG-106



DG-101



DG-108



DG-102



DG-109



Glow Plugs | Photo Guide

DG-110



DG-114



DG-111



DG-115



DG-112



DG-116



DG-113



DG-117



Glow Plugs | Photo Guide

DG-118



DG-123



DG-119



DG-124



DG-121



DG-126



DG-122



DG-127



Glow Plugs | Photo Guide

DG-129



DG-137



DG-130



DG-139



DG-132



DG-140



DG-133



DG-142



Glow Plugs | Photo Guide

DG-143



DG-155



DG-144



DG-157



DG-145



DG-159



DG-146



DG-161



Glow Plugs | Photo Guide

DG-162



DG-173



DG-170



DG-174



DG-171



DG-175



DG-172



DG-176



Glow Plugs | Photo Guide

DG-177



DG-182



DG-178



DG-183



DG-180



DG-184



DG-181



DG-186

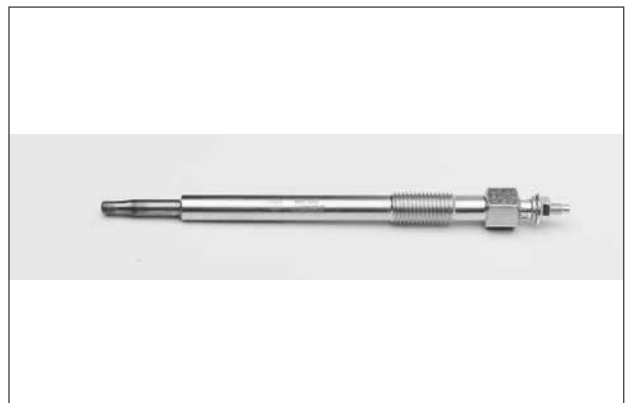

Glow Plugs | Photo Guide

DG-187



DG-191



DG-188



DG-192



DG-189

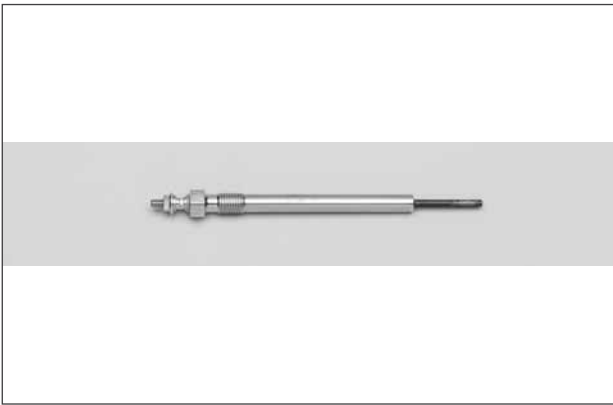

DG-193



DG-190



DG-194



Glow Plugs | Photo Guide

DG-195



DG-202



DG-196



DG-211



DG-197

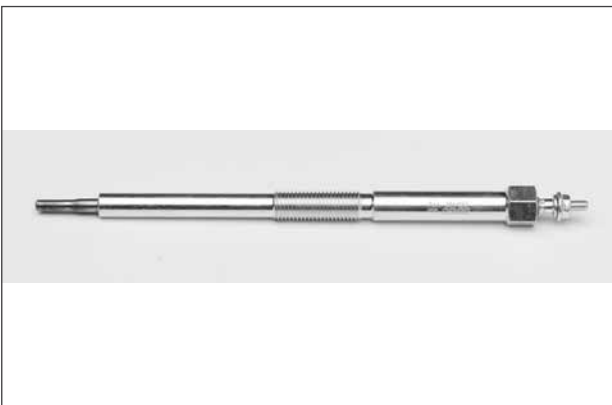

DG-212



DG-198



DG-213



Glow Plugs | Photo Guide

DG-214



DG-219



DG-215



DG-220



DG-216



DG-221

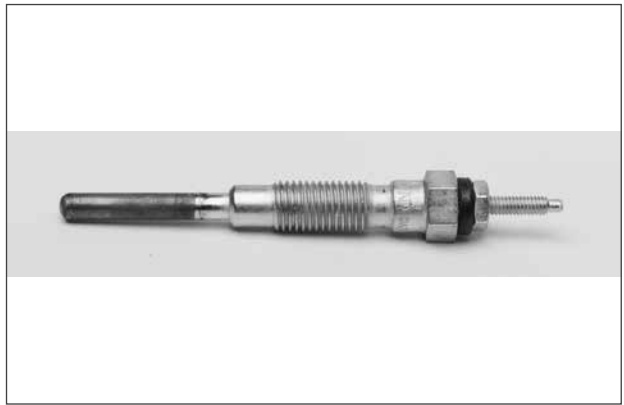

DG-218



DG-222



Glow Plugs | Photo Guide

DG-223



DG-233



DG-224



DG-234



DG-228



DG-238



DG-231



DG-240



Glow Plugs | Photo Guide

DG-241



DG-301



DG-242



DG-302



DG-245



DG-304



DG-300



DG-305



Glow Plugs | Photo Guide

DG-306



DG-312



DG-307



DG-502



DG-310



DG-600



DG-311



DG-601



Glow Plugs | Photo Guide

DG-602



DG-606

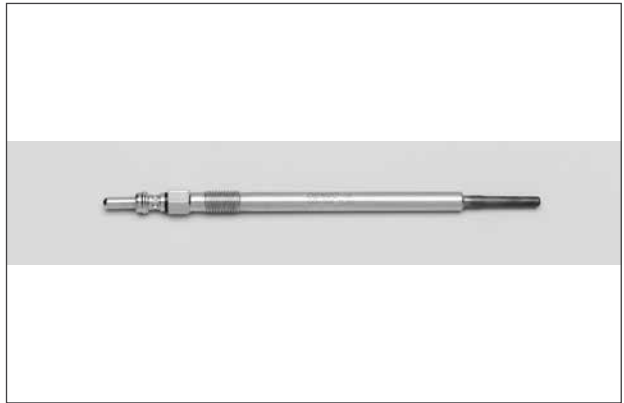

DG-603



DG-607



DG-604

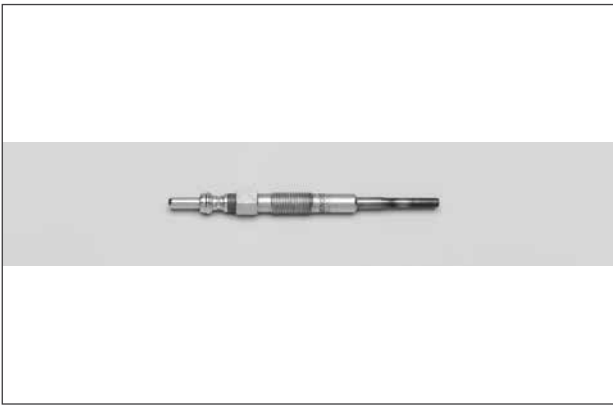

DG-608

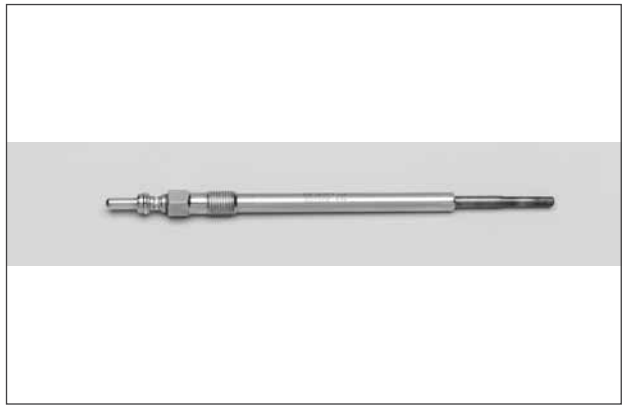

DG-605

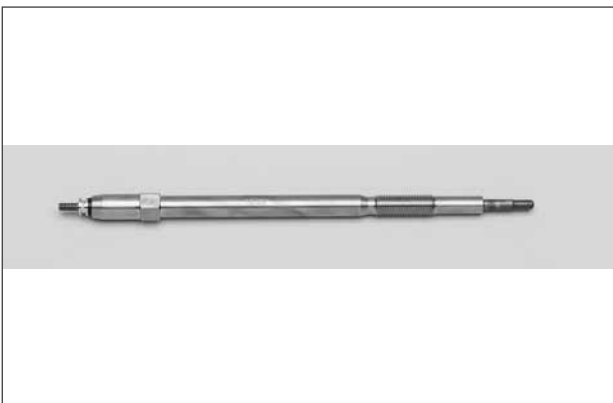

DG-609



Glow Plugs | Photo Guide

DG-610



DG-702



DG-614



DG-619













DG-621

No image available











DENSO Technical Overview



Glow Plugs | Technical Overview

										
	V	mm	mm	mm	mm	mm	mm	mm	mm	mm
DG-001	11	M12x1,25	72	24.3	6.1 Probe	12	15-20	Thread	3-4	
DG-003	11	M10x1	89	29.6	5 Probe	10	10-12	Thread	1-1.5	
DG-004	11.5	M12x1,25	70	20.3	5 Probe	12	15-20	Thread	1-1.5	
DG-005	11	M10x1	92	24.6	5 Probe	10	10-12	Pin	-	
DG-006	11	M12x1,25	67	24.3	6.1 Probe	12	15-20	Thread	3-4	
DG-007	11.5	M12x1,25	63	17.3	6.1 Probe	12	15-20	Thread	3-4	
DG-008	11	M10x1	93	24.6	5 Probe	10	10-12	Thread	1-1.5	
DG-009	11	M12x1,25	70	25.3	5 Probe	12	15-20	Thread	1-1.5	
DG-010	11.5	M12x1,25	70	22.3	6.1 Probe	12	15-20	Thread	3-4	
DG-012	11	M12x1,25	62.2	20.3	6.1 Probe	12	15-20	M5x0.8	3-4	
DG-101	11	M10x1	84	24.5	5 Probe	10	10-12	Thread	1-1.5	
DG-102	11	M12x1,25	71.5	24.3	5 Probe	12	15-20	Thread	1-1.5	
DG-104	11	M10x1,25	80	16.9	5 Probe	12	10-12	Thread	1-1.5	
DG-106	11.5	M12x1,25	114	27.3	6.1 Probe	12	15-20	Pin	-	
DG-108	11	M12x1,25	135	23.85	5 Probe	12	15-20	Thread	1-1.5	
DG-109	11	M10x1	97	29.6	5 Probe	10	10-12	Pin	-	
DG-110	11.5	M12x1,25	87	27.3	5 Probe	12	15-20	Pin	-	
DG-111	11	M10x1	76	24.6	5 Probe	10	10-12	Thread	1-1.5	
DG-112	11	M10x1	99	24.6	5 Probe	10	10-12	Pin	-	
DG-113	11	M8x1	118.5	27.7	5 Probe	8	8-10	Thread	1-1.5	
DG-114	7	M10x1,25	86	22	5 Probe	12	10-12	Thread	1-1.5	
DG-115	11.5	M10x1	125	26	5 Probe	10	10-12	Thread	1-1.5	
DG-116	11	M10x1	107.5	27.6	5 Probe	10	10-12	Thread	1-1.5	
DG-117	11.5	M10x1	130	26.6	5 Probe	10	10-12	Pin	-	
DG-118	11	M10x1	133	28.6	5 Probe	10	10-12	Pin	-	
DG-119	11.5	M12x1,25	120	27.3	6.1 Probe	12	15-20	Pin	-	
DG-121	10	M10x1	95	24.6	5 Probe	10	10-12	Thread	1-1.5	
DG-122	11	M10x1	102.4	23.9	5 Probe	10	10-12	Pin	-	
DG-123	11	M12x1,25	67	19.3	6.1 Probe	12	15-20	Thread	3-4	
DG-124	11	M10x1,25	87	23.9	5 Probe	12	10-12	Thread	1-1.5	
DG-126	11	M10x1	150.5	24	5 Probe	10	10-12	Pin	-	
DG-127	11	M10x1	95	24.4	5 Probe	10	10-12	Thread	1-1.5	
DG-129	11	M12x1,25	75.2	20.3	6.1 Probe	12	15-20	Pin	-	
DG-130	11.5	M10x1	147	35	5 Probe	10	10-12	Thread	1-1.5	
DG-132	11	M10x1	82	24.6	5 Probe	10	10-12	Thread	1-1.5	
DG-133	11	M10x1	126	28.6	5 Probe	10	10-12	Thread	1-1.5	
DG-137	11	M10x1,25	85	19.1	5 Probe	12	10-12	M4x0.7	1-1.5	
DG-139	11	M10x1	149.5	26	5 Probe	8	10-12	Pin	-	
DG-140	11	M8x1	126	24.5	4 Probe	8	8-10	Pin	-	
DG-142	11	M10x1	135	30.6	5 Probe	10	10-12	Pin	-	
DG-143	5	M10x1,25	90	23.5	5 Probe	12	15-20	Thread	1-1.5	
DG-144	11	M10x1	125	33.6	5 Probe	10	10-12	Pin	-	
DG-145	11	M10x1	105	31.6	5 Probe	10	10-12	Pin	-	
DG-146	11	M10x1,25	83	21.9	5 Probe	12	10-12	Thread	1-1.5	
DG-155	11.5	M10x1	128	29.6	5 Probe	10	10-12	Thread	1-1.5	
DG-157	11	M10x1,25	68	16.9	5 Probe	12	10-12	Thread	1-1.5	
DG-159	5	M10x1,25	83	18	5 Probe	12	10-12	Thread	1-1.5	
DG-161	11	M10x1	117	33.6	5 Probe	10	10-12	Thread	1-1.5	
DG-162	6	M10x1,25	95	22	5 Probe	12	10-12	M4x0.7	1-1.5	
DG-170	11	M9x1	151	29.6	4 Probe	9	8-10	Pin	-	
DG-171	11	M8x1	119	27.6	4 Probe	8	8-10	Pin	-	
DG-172	11	M10x1,25	97	21.85	5 Probe	12	10-12	Thread	1-1.5	
DG-173	11	M10x1	111.5	29.6	5 Probe	10	10-12	Thread	1-1.5	
DG-174	11	M10x1,25	82	18.9	5 Probe	12	10-12	Thread	1-1.5	
DG-175	10.5	M10x1	78.4	28.3	5 Probe	3/8"	10-12	Faston	-	
DG-176	11.5	M10x1	130	25.5	5 Probe	10	10-12	Pin	-	
DG-177	5	M10x1	96	29.1	5 Probe	10	10-12	Pin	-	
DG-178	5	M10x1	105	31.6	5 Probe	10	10-12	Pin	-	
DG-180	11	M8x1	125	27.7	3.5 Probe	8	8-10	Pin	-	
DG-181	11	M10x1	118	26.8	5 Probe	12	10-12	M4x0.7	1-1.5	
DG-182	11	M10x1	106	23.5	5 Probe	10	10-12	Pin	-	
DG-183	11.5	M10x1	130	25.5	5 Probe	10	10-12	Pin	-	
DG-184	11.5	M10x1	121	39.6	5 Probe	10	10-12	Pin	-	
DG-186	11	M10x1,25	144	24.35	5 Probe	12	10-12	Thread	1-1.5	
DG-187	11	M10x1,25	170	35	5 Probe	12	15-20	Thread	1-1.5	
DG-188	11	M10x1	150	23.8	4 Probe	10	10-12	Pin	-	
DG-189	11	M10x1,25	150	31	3.6 Probe	10	12-15	Pin	1-1.5	
DG-190	4.4	M8x1	117.6	29.6	4 Probe	8	8-10	Pin	-	
DG-191	5	M10x1	133	28.6	5 Probe	10	10-12	Pin	-	

Glow Plugs | Technical Overview

										
		V	mm	mm	mm	mm	mm	mm	mm	mm
DG-192		5	M10x1	133	30	5 Probe	10	10-12	Pin	-
DG-193		4.4	M10x1	126.3	24	4 Probe	10	10-12	Pin	-
DG-194		4.4	M8x1	147.9	26.6	4 Probe	8	8-10	Pin	-
DG-195		11	M8x1	151	39.6	5 Probe	8	8-10	Pin	-
DG-196		11	M10x1	109.5	30.2	5 Probe	10	10-12	Pin	-
DG-197		11	M10x1	177.8	20.5	4.4 Probe	12	12-15	M4x0.7	1-1.5
DG-198		11	M10x1.25	89.9	21.85	5 Probe	12	10-12	Thread	1-1.5
DG-202		11	M12x1.25	77	29.3	6.1 Probe	12	15-20	Thread	3-4
DG-211		11	M10x1.25	95.5	32	4.3 Probe	12	10-12	Thread	1-1.5
DG-212		11	M10x1.25	95.5	32	4.3 Probe	12	10-12	M4x0.7	-
DG-213		6	M10x1.25	95.5	32	3.6 Probe	12	10-12	M4x0.7	1-1.5
DG-214		11	M10x1.25	102.5	28	4.3 Probe	12	10-12	M4x0.7	1-1.5
DG-215		7	M10x1.25	95.5	32	4.3 Probe	12	10-12	M4x0.7	1-1.5
DG-216		11	M10x1.25	101.5	28	5 Probe	12	10-12	M4x0.7	1-1.5
DG-218		11	M10x1.25	94	30.5	4.3 Probe	12	10-12	M4x0.7	1-1.5
DG-219		23	M10x1.25	101.5	28	5 Probe	12	10-12	M4x0.7	1-1.5
DG-220		6	M10x1.25	100.5	28	5 Probe	12	10-12	M4x0.7	1-1.5
DG-221		11	M10x1.25	95.5	32	5.2 Probe	12	10-12	M4x0.7	1-1.5
DG-222		14	M10x1.25	100.5	28	5 Probe	12	10-12	M4x0.7	1-1.5
DG-223		7	M10x1.25	101.5	28	5 Probe	12	10-12	M4x0.7	1-1.5
DG-224		8	M10x1.25	89	28	5 Probe	17	20-25	M5x0.8	3-4
DG-228		19	M18x1.5	78	21	5 Probe	26	30-40	M5x0.8	3-4
DG-231		21.5	M10x1.25	94.5	22	5 Probe	12	10-12	M5x0.8	3-4
DG-233		23	M10x1.25	101.5	28	5 Probe	12	10-12	M4x0.7	1-1.5
DG-234		8.5	M10x1.25	101.5	28	5 Probe	12	10-12	M4x0.7	1-1.5
DG-238		23	M10x1.25	91.5	32	5 Probe	12	10-12	M5x0.8	3-4
DG-240		11	M10x1.25	160	36	5 Probe	10	12-15	M4x0.7	1-1.5
DG-241		6	M12x1.25	141	24	5 Probe	12	15-20	M4x0.7	1-1.5
DG-242		11	M10x1.25	95.5	32	5 Probe	12	10-12	M4x0.7	1-1.5
DG-245		11	M10x1.25	170	36.6	3.5 Probe	12	10-12	Thread	1-1.5
DG-300		11	M10x1.25	87.5	18	4.5 Probe	12	10-12	Thread	1-1.5
DG-301		11	M10x1.25	81.5	18	4.5 Probe	12	10-12	Thread	1-1.5
DG-302		11	M10x1.25	144.4	24	4.5 Probe	12	10-12	Pin	-
DG-304		11	M10x1.25	96.5	19	4.5 Probe	12	10-12	Thread	1-1.5
DG-305		11	M10x1.25	103.8	25	3.5 Probe	12	10-12	Thread	1-1.5
DG-306		11	M10x1.25	84	21.4	4.5 Probe	12	10-12	Thread	1-1.5
DG-307		11	M10x1.25	82	18.7	4.5 Probe	12	10-12	Thread	1-1.5
DG-310		11	M10x1.25	103.8	28	3.5 Probe	12	10-12	M4x0.7	1-1.5
DG-311		11	M10x1.25	85.4	21.4	3.7 Probe	12	10-12	Thread	1-1.5
DG-312		11	M10x1.25	133	24	3.7 Probe	12	10-12	M4x0.7	1-1.5
DG-502		11	M12x1.25	121.5	30	3.5 Probe	12	10-12	M4x0.7	1-1.5
DG-600		11	M10x1.25	160	28.5	3.5 Probe	10	12-15	M4x0.7	1-1.5
DG-601		11	M10x1.25	160.9	31	4 Probe	12	15-20	Pin	-
DG-602		11	M10x1.25	134.5	30	5 Probe	12	12-15	M4x0.7	1-1.5
DG-603		5	M8x1	113.9	27.5	4 Probe	8	10-12	Pin	-
DG-604		4.4	M8x1	93.9	29	4 Probe	8	10-12	Pin	-
DG-605		11	M10x1.25	213	23	4.3 Probe	12	12-15	M4x0.7	1-1.5
DG-606		11.5	M8x1	147.9	26.5	4 Probe	8	10-12	Pin	-
DG-607		4.4	M10x1	1,335	28	4 Probe	10	12-15	Pin	-
DG-608		4.4	M9x1	156.4	35	4 Probe	9	10-12	Pin	-
DG-609		4.4	M10x1	96.4	24.0	4 Probe	10	10-12	Pin	-
DG-610		4.4	M8x1	135.0	27.5	4 Probe	8	8-10	Pin	-
DG-614		11	M8x1.0	98.4	27.5	4 Probe	8	8-10	Pin	-
DG-619		4.4	M10x1	905	24.0	4 Probe	10	12-15	Pin	-
DG-621		4.4	M9x1	119	27.5	3.3 Probe	9	8-10	Pin	-
DG-702		24	M10x1.25	70	19	5 Probe	12	15-20	M4x0.7	1-1.5















Spark Plugs | Abbreviations

	GB	DE	FR	ES	IT	SE	PL	RU
	Vehicle: Make, Model, Engine capacity	Fahrzeug: Fabrikat, Modell, Motorkapazität	Véhicule: Marque, modèle, capacité de moteur	Vehículo: marca, modelo, capacidad del motor	Veicolo: Marca, Modello, capacità del motore	Fordon: Tillverkare, modell, cylindervolym	Pojazd: marka, model, pojemność silnika	Автомобиль: марка, модель, объем двигателя
KW	Engine power	Motorleistung	Puissance du moteur	Puissance du moteur	Potenza del motore	Motoreffekt	Moc silnika	Мощность двигателя
	Engine code	Motorkennbuchstaben	Code du moteur	Código del motor	Codice del motore	Motorkod	Kod silnika	Код двигателя
	Additional information	Zusätzliche Information	Informations complémentaires	Información adicional	Informazioni aggiuntive	Ytterligare information	Informacje dodatkowe	Дополнительная информация
	Year (from - to)	Jahr (von - bis)	Année (de - à)	Año (de - a)	Anno (da - a)	År (från - till)	Rok (od - do)	Год (с - по)
	Spark Plug	Zündkerzen	bougie	bujía	candele	Tändstift	Świeca zaplonowa	Свеча зажигания
	Stocknumber	Vorratnummer	Stocknuméro	Stocknumero	Scortenumero	Lagernummer	Nr katalogowy	Артикул
4 PACK	4-pack	4er Pack	Pack de 4	paquetes de 4	confezione da quattro pezzi	4-pack	Opakowanie 4-szt.	Упаковка по 4 шт.
	Spark gap	Zündstrecke	Écartement des pointes	Espacio de chispa	Distanza della scintilla	Gnistgap	Szczelina iskrowa	Искровой зазор
	Iridium Power	Iridium Power	Iridium Power	Iridium Power	Iridium Power	Iridium Power	Iridium Power	Iridium Power
	Iridium Tough	Iridium Tough	Iridium Tough	Iridium Tough	Iridium Tough	Iridium Tough	Iridium Tough	Iridium Tough
	Liquefied Petroleum Gas Iridium Tough	Iridium Tough Autogas	Iridium Tough gaz de pétrole liquéfié	Iridium Tough gas licuado de petróleo	Iridium Tough Gas di petrolio liquefatto	Iridium Tough Naturgas	Iridium Tough Gaz płynny (LPG)	Iridium Tough для двигателей на сжиженном газе
	TT Plug	TT-Zündkerze	Bougie TT	Bujía TT	Candela TT	TT tändstift	Świeca TT	Свеча зажигания TT
Cat.	Catalytic converter	Katalysator	Katalysator	convertidor catalítico	convertidor catalítico	Katalysator	Katalizator	Катализатор выхлопных газов
cc	Cubic Centimetre	Kubikzentimeter	convertisseur catalytique	centímetro cúbico	Centimetro cubo	Kubikcentimeter	Centymetr sześcienny	Кубический сантиметр
CDI	Capacitor Discharge Ignition	Kondensatorent ladungszündung	Allumage à décharge de condensateur	encendido por descarga de condensador	Accensione a scarica capacitiva	Elektroniskt tändsystem	Zapłon w wyniku rozładowania kondensatora	Конденсаторная (тиристорная) система зажигания
cu.in	Cubic Inch	Kubikzoll	cylindrée	pulgada cúbica	Pollice cubo	Kubiktum	Cal sześcienny	Кубический дюйм

Spark Plugs | Abbreviations

	GB	DE	FR	ES	IT	SE	PL	RU
EFI,i,INJ,i.e.	Electronic fuel injection	Elektronische Benzineinspritzung	injection électronique	inyección electrónica de combustible	Iniezione elettronica del carburante	Elektronisk bränsleinsprutning	Wtrysk paliwa sterowany elektronicznie	Впрыск топлива с электронным управлением
EGR	Exhaust Gas Recirculation	Abgasrückführung	recirculation des gaz d'échappement	recirculación de los gases de escape	Ricicolo dei gas di scarico	Avgasrecirkulation	Recyrkulacja spalin	Рециркуляция выхлопных газов
FI	Fuel Injection	Kraftstoffeinspritzung	injection de carburant	inyección de combustible	Iniezione di carburante	Bränsleinsprutning	Wtrysk paliwa	Впрыск топлива
FSI	Fuel Stratified Injection (Direct fuel injection)	Benzin-Direkteinspritzung mit Schichtladung	Fuel Stratified Injection (injection directe de carburant)	inyección estratificada de combustible (inyección directa de combustible)	Iniezione stratificata del carburante (Iniezione diretta del carburante)	Direkt bränsleinsprutning	Silnik FSI (bezpośredni wtrysk mieszanki uwarstwionej)	Послойный впрыск топлива (прямой впрыск топлива)
HC	High Compression	Hohe Verdichtung	compression élevée	alta compresión	Alta compressione	Hög kompression	Wysokie sprężanie	Высокая степень сжатия
UPP, JPP, FRP	U.K- production, Japan -Production, France-Production	britische Produktion, japanische Produktion, französische Produktion	production britannique, production japonaise, production française	producción Reino Unido, producción Japón, producción Francia	Produzione: Gran Bretagna, Produzione: Giappone, Produzione: Francia	Tillverkad i Storbritannien, tillverkad i Japan, tillverkad i Frankrike	Wielka Brytania - produkcja, Japonia - produkcja, Francja - produkcja	Сделано в Великобритании, Сделано в Японии, Сделано во Франции
LC	Low Compression	Niedrige Verdichtung	compression basse	baja compresión	Bassa compressione	Låg kompression	Niskie sprężanie	Низкая степень сжатия
LPG	Liquefied Petroleum Gas	Autogas	gaz de pétrole liquéfié	gas licuado de petróleo	Gas di petrolio liquefatto	Naturgas	Gaz płynny (LPG)	Сжиженный газ
L, Ltr.	Litre	Liter	litre	litro	Litro	Liter	Litr	Литр
Mpi	Multi Point injection	Mehrpunkteinspritzung	injection multipoint de carburant	inyección multipunto	Iniezione Multi-Point (pluripunto)	Flerpunktsinsprutning	Wtrysk wielopunktowy	Многоточечный впрыск
Org. Nr.	Organisation number (Citroen/Peugeot production numbering)	Organisationsnummer (Citroen/Peugeot-Produktnummerierung)	numéro d'organisation (numéro de production Citroën/Peugeot)	número de organización (numeración de producción Citroen/Peugeot)	Numero d'organizzazione (numerazione di produzione Citroen/Peugeot)	Organisationsnummer (Citroën/Peugeot tillverkningsnumrering)	Numer organizacyjny (numer produkcyjny Citroen/Peugeot)	Серийный номер (нумерация продукции фирм Ситроен/Пежо)
Spi	Single Point injection	Zentraleinspritzung	injection de carburant dans le corps de papillon	inyección monopunto	Iniezione a punto singolo	Enpunktsinsprutning	Wtrysk jednopunktowy	Одноточечный впрыск
VV	Variable venturi	Variabler Venturi	diffuseur variable	venturi variable	Venturi variabile	Variabel förgasarshalsvidd	Gaźnik z nastawną gardzielą	Регулируемая операция
VVT	Variable Valve Timing	Variable Ventilsteuerung	distribution à programme variable	reglaje de válvula variable	Tempo operativo della valvola variabile	Variabla ventiltider	Zmienny rozrząd zaworowy	Регулирование открытия клапанов
2V	Two stage carburettor	Zweistufenvergaser	carburateur à deux phases	carburador de dos etapas	Carburatore a due stadi	Tvåstegsförgasare	Gaźnik dwustopniowy	Двухкамерный карбюратор
W/O	Without	Ohne	sans	sin	Senza	Utan	Bez	Без

Glow Plugs | Abbreviations

	GB	DE	FR	ES	IT	SE	PL	RU
Ch No	Chassis number	Fahrgestellnummer	Numéro de châssis	Número de chassis	Numero (di serie) del telaio	Chassinummer	Nr podwozia	Номер шасси
Eng No	Engine number	Motornummer	Numéro de moteur	Número de motor	Numero (di serie) del motore	Motornummer	Kod silnika	Номер двигателя
	Vehicle: Make, Model, Engine capacity	Fahrzeug: Fabrikat, Modell, Motorkapazität	Véhicule: Marque, modèle, capacité de moteur	Vehículo: marca, modelo, capacidad del motor	Veicolo: Marca, Modello, capacità del motore	Fordon: märke, modell, motorkapacitet	Pojazd: marka, model, pojemność silnika	Автомобиль: марка, модель, объем двигателя
KW	Engine power	Motorleistung	Puissance du moteur	Potencia del motor	Potenza del motore	Motoreffekt	Moc silnika	Код двигателя
	Additional Information	Zusätzliche Information	Informations complémentaires	Información adicional	Informazioni aggiuntive	Kompleterande information	Informacje dodatkowe	Дополнительная информация
	Engine code	Motorkennbuchstaben	Code du moteur	Código del motor	Codice del motore	Motorkod	Kod silnika	Код двигателя
	Year (from - to)	Jahr (von - bis)	Année (de - à)	Año (de - a)	Anno (da - a)	År (från - till)	Rok (od - do)	Год (с - по)
	Glow plug part number (short code)	Teilenummer - Glühkerze (Kurzschlüssel)	Numéro de pièce de bougie de préchauffage (code abrégé)	Número referencia de la bujía de calentador (código corto)	Codice articolo candeletta ad incandescenza (codice abbreviato)	Glödstift -delnummer (kortnummer)	Nr katalogowy świecy żarowej (kod skrócony)	Каталожный номер свечи накаливания (сокращенный код)
	Voltage	Volt	Tension	Tensión	Voltaggio	Spänning	Napięcie	Напряжение
	Thread size	Gewindegröße	Dimension de filetage	Tamaño de la rosca	Dimensione del filetto	Gångstorlek	Rozmiar gwintu	Диаметр резьбы
	Overall length	Gesamtlänge	Longueur totale	Longitud total	Lunghezza totale	Total längd	Długość całkowita	Общая длина
	Probe length	Fühlerlänge	Longueur de sonde	Longitud del sensor	Lunghezza della sonda	Sondens längd	Długość świecy	Длина наконечника
	Probe diameter	Fühlerdurchmesser	Diamètre de sonde	Diámetro del sensor	Diametro della sonda	Sondens diameter	Średnica świecy	Диаметр наконечника
	Hexagon size	Sechskantgröße	Taille hexagonale	Tamaño del hexágono	Dimensione dell'esagono	Hexagonstorlek	Rozmiar części sześciokątnej	Размер под ключ
	Glow plug installation torque	Drehmoment: Glühkerzenmontage	Couple d'installation de bougie de préchauffage	Torción para la instalación de la bujía de calentador	Coppia di serraggio per l'installazione della candeletta ad incandescenza	Glödstiftets installations- moment	Moment dokręcania świecy żarowej	Момент затяжки свечи накаливания
	Terminal type	Rundmutter-Typ	Type de plot	Tipo de terminal	Tipo di terminale	Kontakttyp	Typ złącza	Тип клеммы контактного стержня
	Terminal installation torque	Drehmoment: Rundmuttermontage	Couple d'installation de plot	Torción para la instalación del terminal	Coppia di serraggio per l'installazione del terminale	Kontaktens installations-moment	Moment dokręcania złącza	Момент затяжки клеммы

DENSO Europe B.V.
Hogesweyselaan 165
1382 JL Weesp
The Netherlands

Tel: +31 (0)294 493 493
Fax: +31 (0)294 417 122
marketing@denso.nl
www.denso-am.eu

